

3 Motor protection relays



- Thermal overload relays for currents between 0.09 and 420A
- Electronic thermal overload relays for currents between 0.4 and 45A
- Electronic thermal overload relays with selectable tripping class: 5-10-20-30
- Phase failure sensitive and non phase failure sensitive versions
- Automatic and/or manual resetting
- Independent or direct mounting on contactor
- Thermistor protection relay.

Thermal overload relays

For BG series mini-contactors	3 - 2
For BF series contactors	3 - 4
For BF and B series contactors	3 - 8
Accessories	3 - 10

Electronic thermal overload relays

For BF series contactors	3 - 11
--------------------------------	--------

Electronic relay

Thermistor protection relays	3 - 12
------------------------------------	--------

Dimensions	3 - 13
-------------------------	---------------

Wiring diagrams	3 - 14
------------------------------	---------------

Technical characteristics	3 - 15
--	---------------

Type of contactor	TYPE OF THERMAL OVERLOAD RELAY				Pages	ELECTRONIC THERMAL OVERLOAD RELAYS	
	Phase failure / single phase sensitive		Non phase failure / non single phase sensitive			Phase failure / single phase sensitive Manual/hand or automatic reset	Pages
	Manual/hand reset	Automatic reset	Manual/hand reset	Automatic reset			
BG06...BG12	RF9	RFA9	RFN9	RFNA9	3-2 and 3-3	—	—
BF09...BF38	RF38		RFN38		3-4 and 3-6	RFE45	3-11
BF40...BF94	RF82	RFA82	RFN82	RFNA82	3-5 and 3-7	—	—
BF95...BF150❶	RF110	RFA110	RFN110	RFNA110	3-5 and 3-7	—	—
BF160...BF230	RF200		RFN200		3-8 and 3-9	—	—
BF195...BF400	RF400		RFN400				

❶ For currents higher than 110A use RF200 (independent mounting).

SEC. - PAGE



Page 3-2

FOR BG SERIES MINI-CONTACTORS

- Type RF9, phase failure sensitive, manual resetting
- Type RFA9, phase failure sensitive, automatic resetting
- Type RFN9, non phase failure sensitive, manual resetting
- Type RFNA9, non phase failure sensitive, automatic resetting.



Page 3-4

FOR BF SERIES CONTACTORS

- Type RF38, phase failure sensitive, manual or automatic resetting
- Type RFN38, non phase failure sensitive, manual or automatic resetting
- Type RF82 and RF110, phase failure sensitive, manual resetting
- Type RFA82 and RFA110, phase failure sensitive, automatic resetting
- Type RFN82 and RFN110, non phase failure sensitive, manual resetting
- Type RFNA82 and RFNA110, non phase failure sensitive, automatic resetting.



Page 3-8

FOR BF AND B SERIES CONTACTORS

- Type RF200 and RF420, phase failure sensitive, manual or automatic resetting
- Type RFN200 and RFN420, non phase failure sensitive, manual or automatic resetting.



Page 3-11

ELECTRONIC THERMAL OVERLOAD RELAYS FOR BF SERIES CONTACTORS

- Phase failure sensitive, manual or automatic resetting
- Selectable tripping class: 5-10-20-30
- High reliability and accuracy of tripping
- Minimal heat dissipation
- Wide current adjustment range.



Page 3-12

THERMISTOR PROTECTION RELAY

- 24VDC and 24 to 240VAC supply types.



LOVATO Electric motor protection relays are suitable for new motors with high IE3 efficiency values

RF38 features

FRONT PROTECTION COVER OF THERMAL OVERLOAD RELAYS

A sealable protection cover is available. When fitted on to the relay front, it precludes all possible adjuster tampering and involuntary activation of the "Reset" and "Stop" buttons of the thermal overload relay.



CLEAR IDENTIFICATION OF THERMAL OVERLOAD RELAY MANUAL OR AUTOMATIC RESETTING

The RF38 thermal overload relay is supplied configured for manual resetting. Breaking the plate below the "Reset" button allows for the automatic resetting configuration.



FIXING EASE OF THE THERMAL OVERLOAD RELAY

While the thermal overload relay is being linked to the contactor, its auxiliary contact fits on and connects to the coil terminal by rigid terminal. Complete relay fixing is done in a single operation, with no need of other connections.

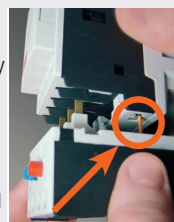

SEALABLE RELAY COVER

A handy closing flap feature excludes any tampering of the thermal overload relay adjuster.



3 Motor protection relays

Thermal overload relays.
For BG series mini-contactors

Phase failure / single phase sensitive Three poles (three phase)



11RF9...



11RFA9...

Order code	Adjustment range	Protection fuses IEC			Qty per pkg	Wt [kg]
		aM [A]	gG [A]	UL K5 [A]		
	[A]	[A]	[A]	[A]	n°	[kg]

MANUAL RESETTING.
Direct mounting on BG06, BG09, BG12 mini-contactors.

11RF9015	0.09...0.15	0.25	—	—	1	0.116
11RF9023	0.14...0.23	0.5	—	1	1	0.116
11RF9033	0.2...0.33	0.5	1	1	1	0.116
11RF905	0.3...0.5	1	2	3	1	0.116
11RF9075	0.45...0.75	1	2	3	1	0.116
11RF91	0.6...1	2	4	3	5	0.116
11RF91V5	0.9...1.5	2	4	6	5	0.116
11RF92V3	1.4...2.3	4	6	10	5	0.116
11RF933	2...3.3	4	10	10	5	0.116
11RF95	3...5	6	16	15	5	0.116
11RF975	4.5...7.5	8	20	25	5	0.116
11RF910	6...10	10	32	30	5	0.116
11RF915	9...15	16	40	45	5	0.116

AUTOMATIC RESETTING.
Direct mounting on BG06, BG09, BG12 mini-contactors.

11RFA9015	0.09...0.15	0.25	—	—	1	0.116
11RFA9023	0.14...0.23	0.5	—	1	1	0.116
11RFA9033	0.2...0.33	0.5	1	1	1	0.116
11RFA905	0.3...0.5	1	2	3	1	0.116
11RFA9075	0.45...0.75	1	2	3	1	0.116
11RFA91	0.6...1	2	4	3	1	0.116
11RFA91V5	0.9...1.5	2	4	6	1	0.116
11RFA92V3	1.4...2.3	4	6	10	1	0.116
11RFA933	2...3.3	4	10	10	1	0.116
11RFA95	3...5	6	16	15	1	0.116
11RFA975	4.5...7.5	8	20	25	1	0.116
11RFA910	6...10	10	32	30	1	0.116
11RFA915	9...15	16	40	45	1	0.116

NOTE: two pole (single phase) versions are available on request. Add the letter "S" in the order code e.g. 11RF9015 is three pole; 11RFS9015 two pole.
The appropriate adjustment range of the overload relay should be selected on the basis of the motor nameplate full-load current when direct, across the line starting is considered.

Three-phase IEC motor powers ①

230V [kW]	400V [kW]	500V [kW]	690V [kW]
-----------	-----------	-----------	-----------

②	②	②	0.06
②	0.06	0.06	0.09
②	0.09	0.09	0.12
0.06	0.12	0.12	0.18
0.09-0.12	0.18	0.18	0.25-0.37
0.12	0.25	0.25-0.37	0.55
0.18	0.37	0.55	0.75
0.25-0.37	0.55-0.75	0.75	1.1-1.5
0.55	1.1	1.1-1.5	1.5-2.2
0.75	1.5	2.2	3
1.1-1.5	2.2-3	3-4	4-5.5
2.2	4	4-5.5	7.5
3	5.5	7.5	11

②	②	②	0.06
②	0.06	0.06	0.09
②	0.09	0.09	0.12
0.06	0.12	0.12	0.18
0.09-0.12	0.18	0.18	0.25-0.37
0.12	0.25	0.25-0.37	0.55
0.18	0.37	0.55	0.75
0.25-0.37	0.55-0.75	0.75	1.1-1.5
0.55	1.1	1.1-1.5	1.5-2.2
0.75	1.5	2.2	3
1.1-1.5	2.2-3	3-4	4-5.5
2.2	4	4-5.5	7.5
3	5.5	7.5	11

- ① The indicated powers apply to 4-pole motors; it is advisable to always check that the nameplate motor current is within the relay adjustment range.
- ② No standard power ratings exist; select relay according to current consumption.

NOTE: to facilitate connection between the auxiliary NC contact of the RF...9 thermal relay and terminal A2 of the contactor, insert the conductor into the appropriate conduit as shown.

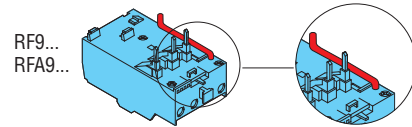

RF9...
RFA9...

Certifications and compliance

Certifications obtained:

Type	cULus	CSA	EAC	CCC
RF9... - RFA9...	●	●	●	●

● Certified products.

cULus – UL Listed for USA and Canada (cULus - File E93601) as Auxiliary Devices – Thermal Overload Relays, 600VAC, open type, ambient compensated, 5000 Amps RMS symmetrical short circuit rating; the trip current is 120% FLA.
CSA – CSA certified for Canada only (File 54332) as Auxiliary Devices for use with magnetic contactors.

Compliant with standards: IEC/EN/BS 60947-1, IEC/EN/BS 60947-4-1, UL 60947-1, UL 60947-4-1, CSA C22.2 n° 60947-1, CSA C22.2 n° 60947-4-1.

3 Motor protection relays

Thermal overload relays.
For BG series mini-contactors

**Non phase failure /
non single phase sensitive
Three poles (three phase)**



11RFN9...



11RFNA9...

Order code	Adjustment range	Protection fuses IEC			Qty per pkg	Wt [kg]
		aM [A]	gG [A]	UL K5 [A]		

MANUAL RESETTING.
Direct mounting on BG06, BG09, BG12 mini-contactors.

11RFN9015	0.09...0.15	0.25	—	—	1	0.123
11RFN9023	0.14...0.23	0.5	—	1	1	0.123
11RFN9033	0.2...0.33	0.5	1	1	1	0.123
11RFN905	0.3...0.5	1	2	3	1	0.123
11RFN9075	0.45...0.75	1	2	3	1	0.123
11RFN91	0.6...1	2	4	3	1	0.123
11RFN91V5	0.9...1.5	2	4	6	1	0.123
11RFN92V3	1.4...2.3	4	6	10	1	0.123
11RFN933	2...3.3	4	10	10	1	0.123
11RFN95	3...5	6	16	15	1	0.123
11RFN975	4.5...7.5	8	20	25	1	0.123
11RFN910	6...10	10	32	30	1	0.123
11RFN915	9...15	16	40	45	1	0.123

AUTOMATIC RESETTING.
Direct mounting on BG06, BG09, BG12 mini-contactors.

11RFNA9015	0.09...0.15	0.25	—	—	1	0.123
11RFNA9023	0.14...0.23	0.5	—	1	1	0.123
11RFNA9033	0.2...0.33	0.5	1	1	1	0.123
11RFNA905	0.3...0.5	1	2	3	1	0.123
11RFNA9075	0.45...0.75	1	2	3	1	0.123
11RFNA91	0.6...1	2	4	3	1	0.123
11RFNA91V5	0.9...1.5	2	4	6	1	0.123
11RFNA92V3	1.4...2.3	4	6	10	1	0.123
11RFNA933	2...3.3	4	10	10	1	0.123
11RFNA95	3...5	6	16	15	1	0.123
11RFNA975	4.5...7.5	8	20	25	1	0.123
11RFNA910	6...10	10	32	30	1	0.123
11RFNA915	9...15	16	40	45	1	0.123

NOTE: the appropriate adjustment range of the overload relay should be selected on the basis of the motor nameplate full-load current when direct, across the line starting is considered.

Three-phase IEC motor powers ①

230V [kW]	400V [kW]	500V [kW]	690V [kW]
0.06	0.06	0.06	0.06
0.09	0.06	0.06	0.09
0.12	0.09	0.09	0.12
0.18	0.12	0.12	0.18
0.25-0.37	0.18	0.18	0.25-0.37
0.55	0.25	0.25-0.37	0.55
0.75	0.37	0.55	0.75
1.1-1.5	0.55-0.75	0.75	1.1-1.5
2.2	1.1	1.1-1.5	1.5-2.2
3	1.5	2.2	3
4	2.2-3	3-4	4-5.5
5.5	4	4-5.5	7.5
7.5	5.5	7.5	11

0.06	0.06	0.06	0.06
0.09	0.06	0.06	0.09
0.12	0.09	0.09	0.12
0.18	0.12	0.12	0.18
0.25-0.37	0.18	0.18	0.25-0.37
0.55	0.25	0.25-0.37	0.55
0.75	0.37	0.55	0.75
1.1-1.5	0.55-0.75	0.75	1.1-1.5
2.2	1.1	1.1-1.5	1.5-2.2
3	1.5	2.2	3
4	2.2-3	3-4	4-5.5
5.5	4	4-5.5	7.5
7.5	5.5	7.5	11

① The indicated powers apply to 4-pole motors; it is advisable to always check that the nameplate motor current is within the relay adjustment range.

② No standard power ratings exist; select relay according to current consumption.

NOTE: to facilitate connection between the auxiliary NC contact of the RFN...9 thermal relay and terminal A2 of the contactor, insert the conductor into the appropriate conduit as shown.

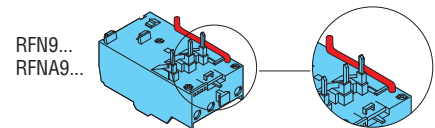

Certifications and compliance

Certifications obtained:

Type	cULus	CSA	EAC	CCC
RFN9... - RFNA9...	●	●	●	●

● Certified products.

cULus – UL Listed for USA and Canada (cULus - File E93601) as Auxiliary Devices – Thermal Overload Relays, 600VAC, open type, ambient compensated, 5000 Amps RMS symmetrical short circuit rating; the trip current is 120% FLA.

CSA – CSA certified for Canada only (File 54332) as Auxiliary Devices for use with magnetic contactors.

Compliant with standards: IEC/EN/BS 60947-1, IEC/EN/BS 60947-4-1, UL 60947-1, UL 60947-4-1, CSA C22.2 n° 60947-1, CSA C22.2 n° 60947-4-1.

3 Motor protection relays

Thermal overload relays.
For BF series contactors

**Phase failure /
single phase sensitive
Three poles (three phase)**



RF38...

Order code	Adjustment range	Protection fuses IEC			Qty per pkg	Wt [kg]
		aM	gG	UL K5		
	[A]	[A]	[A]	[A]	n°	[kg]
RF380016	0.1...0.16	0.25	—	1	1	0.160
RF380025	0.16...0.25	0.5	—	1	1	0.160
RF380040	0.25...0.4	0.5	1	3	1	0.160
RF380063	0.4...0.63	1	2	3	1	0.160
RF380100	0.63...1	2	4	3	5	0.160
RF380160	1...1.6	2	4	6	5	0.160
RF380250	1.6...2.5	4	6	10	5	0.160
RF380400	2.5...4	4	6	15	5	0.160
RF380650	4...6.5	8	16	25	5	0.160
RF381000	6.3...10	10	20	40	5	0.160
RF381400	9...14	16	32	50	5	0.160
RF381800	13...18	25	40	70	5	0.160
RF382300	17...23	25	50	90	5	0.160
RF382500	20...25	32	50	100	5	0.160
RF383200	24...32	40	63	120	1	0.160
RF383800	32...38	40	63	150	1	0.160

MANUAL OR AUTOMATIC RESETTING.
Direct mounting on BF09...BF38 contactors.
Independent mounting with RFX3804 base.

NOTE: two pole (single phase) versions are available on request.
Add the letter "S" in the order code e.g. RF381000 is three pole; RFS381000 two pole.

The appropriate adjustment range of the overload relay should be selected on the basis of the motor nameplate full-load current when direct, across the line starting is considered.

Three-phase IEC motor powers ①

230V [kW]	400V [kW]	500V [kW]	690V [kW]
0.06	0.06	0.06-0.09	0.09-0.12
0.09	0.12-0.18	0.18	0.25
0.12	0.25	0.25-0.37	0.37-0.55
0.18-0.25	0.37-0.55	0.55-0.75	0.75
0.37	0.75	1.1	1.1-1.5
0.55-0.75	1.1-1.5	1.5-2.2	2.2-3
1.1-1.5	2.2	3	4
1.5-2.2	3-4	4-5.5	5.5-7.5
3	5.5	5.5-7.5	11
4	7.5	11	15
5.5	11	11	18.5
5.5	11	15	22
7.5	15	18.5	30
11	18.5	22	30

① The indicated powers apply to 4-pole motors; it is advisable to always check that the nameplate motor current is within the relay adjustment range.

② No standard powers ratings exist; select relay according to current consumption.

Certifications and compliance

Certifications obtained:

Type	cULus	CSA	EAC	CCC	Register of shipping
RF38	●	—	●	●	—

● Certified products.

cULus – UL Listed for USA and Canada (cULus - File E93601) as Auxiliary Devices – Thermal Overload Relays, 600VAC, open type, ambient compensated, 5000 Amps RMS symmetrical short circuit rating; the trip current is 120% FLA.

CSA – CSA certified for Canada only (File 54332) as Auxiliary Devices for use with magnetic contactors.

Compliant with standards: IEC/EN/BS 60947-1, IEC/EN/BS 60947-4-1, UL 60947-1, UL 60947-4-1, CSA C22.2 n° 60947-1, CSA C22.2 n° 60947-4-1.

FIXING EASE OF THE THERMAL OVERLOAD RELAY

While the thermal overload relay is being linked to the contactor, its auxiliary contact fits on and connects to the coil terminal by rigid terminal. Complete relay fixing is done in a single operation, with no need of other connections.

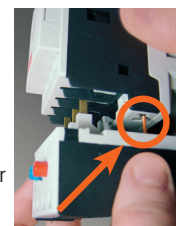

3 Motor protection relays

Thermal overload relays.
For BF series contactors

Phase failure / single phase sensitive Three poles (three phase)



RF82...



RF110...



RFA82...



RFA110...

Order code	Adjustment range	Protection fuses IEC			Qty per pkg	Wt [kg]
		aM	gG	UL K5		
	[A]	[A]	[A]	[A]	n°	[kg]

MANUAL RESETTING.
Direct mounting on BF40...BF94 contactors.
Independent mounting with 11G270 base.

RF823300	20...33	40	63	110	1	0.365
RF824200	28...42	50	80	150	1	0.365
RF825000	35...50	50	100	175	1	0.365
RF826500	46...65	80	125	200	1	0.365
RF828200	60...82	100	200	250	1	0.365
RF829500	70...95	100	200	250	1	0.365

MANUAL RESETTING.
Direct mounting on BF95...BF150 contactors[Ⓜ].
Independent mounting with 11G270 base.

RF110082	60...82	100	200	250	1	0.365
RF110095	70...95	100	200	350	1	0.365
RF110110	90...110	125	200	350	1	0.365

AUTOMATIC RESETTING.
Direct mounting on BF40...BF94 contactors.
Independent mounting with 11G270 base.

RFA823300	20...33	40	63	110	1	0.365
RFA824200	28...42	50	80	150	1	0.365
RFA825000	35...50	50	100	175	1	0.365
RFA826500	46...65	80	125	200	1	0.365
RFA828200	60...82	100	200	250	1	0.365
RFA829500	70...95	100	200	250	1	0.365

AUTOMATIC RESETTING.
Direct mounting on BF95...BF150 contactors[Ⓜ].
Independent mounting with 11G270 base.

RFA110082	60...82	100	200	250	1	0.365
RFA110095	70...95	100	200	350	1	0.365
RFA110110	90...110	125	200	350	1	0.365

NOTE: two pole (single phase) versions are available on request.
Add the letter "S" in the order code e.g. RF828200 is three pole; RFS828200 two pole.
The appropriate adjustment range of the overload relay should be selected on the basis of the motor nameplate full-load current when direct, across the line starting is considered.

[Ⓜ] For BF150 contactor used at current higher than 110A, use RF200 thermal overload relay (independent mounting).

Three-phase IEC motor powers [Ⓛ]

230V [kW]	400V [kW]	500V [kW]	690V [kW]
-----------	-----------	-----------	-----------

5.5-7.5	11-15	15-18.5	18.5-22
11	15-18.5	18.5-22	30-37
11	22	30	37-45
15-18.5	22-30	37-45	45-55
18.5-22	37-45	45-55	75
22	45	55	75-90

18.5-22	37-45	45-55	75
22	45	55	75-90
30	55	75	90

5.5-7.5	11-15	15-18.5	18.5-22
11	15-18.5	18.5-22	30-37
11	22	30	37-45
15-18.5	22-30	37-45	45-55
18.5-22	37-45	45-55	75
22	45	55	75-90

18.5-22	37-45	45-55	75
22	45	55	75-90
30	55	75	90

[Ⓛ] The indicated powers apply to 4-pole motors; it is advisable to always check that the nameplate motor current is within the relay adjustment range.

Certifications and compliance

Certifications obtained:

Type	cULus	CSA	EAC
RF82	●	—	●
RFA82	●	—	●
RF110	●	—	—
RFA110	●	—	—

● Certified products.

cULus – UL Listed for USA and Canada (cULus - File E93601) as Auxiliary Devices – Thermal Overload Relays, 600VAC, open type, ambient compensated, 5000 Amps RMS symmetrical short circuit rating up to 82A FLA range and 10000 Amps RMS for 95A and 110A FLA range; the trip current is 120% FLA.
CSA – CSA certified for Canada only (File 54332) as Auxiliary Devices for use with magnetic contactors.

Compliant with standards: IEC/EN/BS 60947-1, IEC/EN/BS 60947-4-1, UL 60947-1, UL 60947-4-1, CSA C22.2 n° 60947-1, CSA C22.2 n° 60947-4-1.

FIXING EASE OF THE THERMAL OVERLOAD RELAY

While the thermal overload relay is being linked to the contactor, its auxiliary contact fits on and connects to the coil terminal by rigid terminal. Complete relay fixing is done in a single operation, with no need of other connections (for RF...A... version characteristic not present).

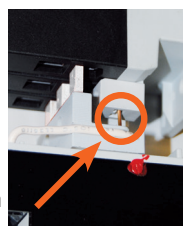

3 Motor protection relays

Thermal overload relays.
For BF series contactors

**Non phase failure /
non single phase
sensitive
Three poles (three phase)**



RFN38...

Order code	Adjustment range	Protection fuses IEC			Qty per pkg	Wt [kg]
		aM	gG	UL K5		
	[A]	[A]	[A]	[A]	n°	

MANUAL OR AUTOMATIC RESETTING.
Direct mounting on BF09...BF38 contactors.
Independent mounting with RFX3804 base.

RFN380016	0.10...0.16	0.25	—	1	1	0.160
RFN380025	0.16...0.25	0.5	—	1	1	0.160
RFN380040	0.25...0.40	0.5	1	3	1	0.160
RFN380063	0.40...0.63	1	2	3	1	0.160
RFN380100	0.63...1	2	4	3	1	0.160
RFN380160	1...1.6	2	4	6	1	0.160
RFN380250	1.6...2.5	4	6	10	1	0.160
RFN380400	2.5...4	4	6	15	1	0.160
RFN380650	4...6.5	8	16	25	1	0.160
RFN381000	6.3...10	10	20	40	1	0.160
RFN381400	9...14	16	32	50	1	0.160
RFN381800	13...18	25	40	70	1	0.160
RFN382300	17...23	25	50	90	1	0.160
RFN382500	20...25	32	50	100	1	0.160
RFN383200	24...32	40	63	125	1	0.160
RFN383800	32...38	40	63	150	1	0.160

NOTE: the appropriate adjustment range of the overload relay should be selected on the basis of the motor nameplate full-load current when direct, across the line starting is considered.

Three-phase IEC motor powers ①

230V [kW]	400V [kW]	500V [kW]	690V [kW]
-----------	-----------	-----------	-----------

②	②	②	0.06
②	0.06	0.06-0.09	0.09-0.12
0.06	0.09	0.12	0.18
0.09	0.12-0.18	0.18	0.25
0.12	0.25	0.25-0.37	0.37-0.55
0.18-0.25	0.37-0.55	0.55-0.75	0.75
0.37	0.75	1.1	1.1-1.5
0.55-0.75	1.1-1.5	1.5-2.2	2.2-3
1.1-1.5	2.2	3	4
1.5-2.2	3-4	4-5.5	5.5-7.5
3	5.5	5.5-7.5	11
4	7.5	11	15
5.5	11	11	18.5
5.5	11	15	22
7.5	15	18.5	30
11	18.5	22	30

- ① The indicated powers apply to 4-pole motors; it is advisable to always check that the nameplate motor current is within the relay adjustment range.
- ② No standard power ratings exist; select relay according to current consumption.

Certifications and compliance

Certifications obtained:

Type	cULus	CSA	EAC	CCC
RFN38	●	—	●	●

● Certified products.

cULus – UL Listed for USA and Canada (cULus - File E93601) as Auxiliary Devices – Thermal Overload Relays, 600VAC, open type, ambient compensated, 5000 Amps RMS symmetrical short circuit rating; the trip current is 120% FLA.

CSA – CSA certified for Canada only (File 54332) as Auxiliary Devices for use with magnetic contactors.

Compliant with standards: IEC/EN/BS 60947-1, IEC/EN/BS 60947-4-1, UL 60947-1, UL 60947-4-1, CSA C22.2 n° 60947-1, CSA C22.2 n° 60947-4-1.

FIXING EASE OF THE THERMAL OVERLOAD RELAY

While the thermal overload relay is being linked to the contactor, its auxiliary contact fits on and connects to the coil terminal by rigid terminal. Complete relay fixing is done in a single operation, with no need of other connections.

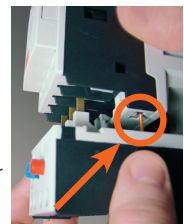

3 Motor protection relays

Thermal overload relays.
For BF series contactors

**Non phase failure /
non single phase sensitive
Three poles (three phase)**



RFN82...



RFN110...



RFNA82...



RFNA110...

Order code	Adjustment range	Protection fuses IEC			Qty per pkg	Wt [kg]
		aM	gG	UL K5		
	[A]	[A]	[A]	[A]	n°	[kg]

MANUAL RESETTING.
Direct mounting on BF40...BF94 contactors.
Independent mounting with 11G270 base.

RFN824200	28...42	50	80	150	1	0.365
RFN825000	35...50	50	100	175	1	0.365
RFN826500	46...65	80	125	200	1	0.365
RFN828200	60...82	100	200	250	1	0.365
RFN829500	70...95	100	200	250	1	0.365

MANUAL RESETTING.
Direct mounting on BF95...BF150 contactors[Ⓢ].
Independent mounting with 11G270 base.

RFN110082	60...82	100	200	250	1	0.365
RFN110095	70...95	100	200	350	1	0.365
RFN110110	90...110	125	200	350	1	0.365

AUTOMATIC RESETTING.
Direct mounting on BF40...BF94 contactors.
Independent mounting with 11G270 base.

RFNA824200	28...42	50	80	150	1	0.365
RFNA825000	35...50	50	100	175	1	0.365
RFNA826500	46...65	80	125	200	1	0.365
RFNA828200	60...82	100	200	250	1	0.365
RFNA829500	70...95	100	200	250	1	0.365

AUTOMATIC RESETTING.
Direct mounting on BF95...BF150 contactors[Ⓢ].
Independent mounting with 11G270 base.

RFNA110082	60...82	100	200	250	1	0.365
RFNA110095	70...95	100	200	350	1	0.365
RFNA110110	90...110	125	200	350	1	0.365

NOTE: the appropriate adjustment range of the overload relay should be selected on the basis of the motor nameplate full-load current when direct, across the line starting is considered.

[Ⓢ] For BF150 contactor used at current higher than 110A, use RFN200 thermal overload relay (independent mounting).

Three-phase IEC motor powers [Ⓢ]

230V [kW]	400V [kW]	500V [kW]	690V [kW]
-----------	-----------	-----------	-----------

11	15-18.5	18.5-22	30-37
11	22	30	37-45
15-18.5	22-30	37-45	45-55
18.5-22	37-45	45-55	75
22	45	55	75-90

18.5-22	37-45	45-55	75
22	45	55	75-90
30	55	75	90

11	15-18.5	18.5-22	30-37
11	22	30	37-45
15-18.5	22-30	37-45	45-55
18.5-22	37-45	45-55	75
22	45	55	75-90

18.5-22	37-45	45-55	75
22	45	55	75-90
30	55	75	90

[Ⓢ] The indicated powers apply to 4-pole motors; it is advisable to always check that the nameplate motor current is within the relay adjustment range.

Certifications and compliance

Certifications obtained:

Type	cULus	CSA	EAC
RFN82	●	—	●
RFNA82	●	—	●
RFN110	●	—	—
RFNA110	●	—	—

● Certified products.

cULus – UL Listed for USA and Canada (cULus - File E93601) as Auxiliary Devices – Thermal Overload Relays, 600VAC, open type, ambient compensated, 5000 Amps RMS symmetrical short circuit rating up to 82A FLA range and 10000 Amps RMS for 95A and 110A FLA range; the trip current is 120% FLA.
CSA – CSA certified for Canada only (File 54332) as Auxiliary Devices for use with magnetic contactors.

Compliant with standards: IEC/EN/BS 60947-1, IEC/EN/BS 60947-4-1, UL 60947-1, UL 60947-4-1, CSA C22.2 n° 60947-1, CSA C22.2 n° 60947-4-1.

FIXING EASE OF THE THERMAL OVERLOAD RELAY

While the thermal overload relay is being linked to the contactor, its auxiliary contact fits on and connects to the coil terminal by rigid terminal. Complete relay fixing is done in a single operation, with no need of other connections (for RF...A... version characteristic not present).

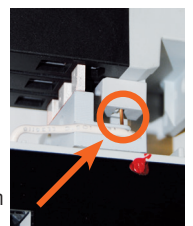

3 Motor protection relays

Thermal overload relays.
For BF and B series contactors

**Phase failure /
single phase sensitive
Three poles (three phase)**



RF200... - RF420...

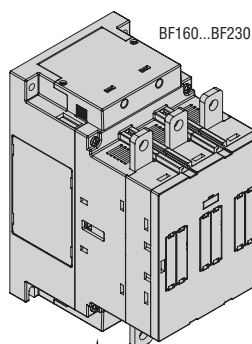

BF160...BF230

RFX20035
RFX42035

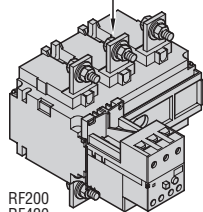

RF200
RF420

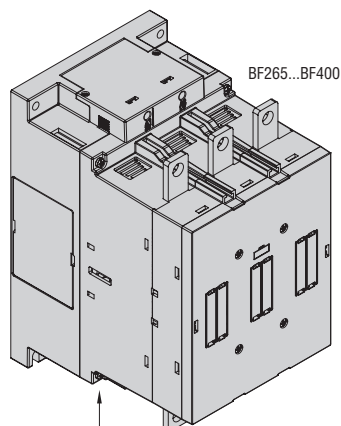

BF265...BF400

RFX20036
RFX42036

RF200
RF420

Order code	Adjustment range	Protection fuses IEC			Qty per pkg	Wt [kg]
		aM	gG	UL K5		
	[A]	[A]	[A]	[A]	n°	[kg]

MANUAL OR AUTOMATIC RESETTING.

Independent screw fixing or direct mounting on contactors:
BF160-BF195-BF230 using RFX20035 links.
BF265-BF330-BF400 using RFX20036 links.

RF200100	60...100	100	160	500	1	2.150
RF200125	75...125	125	200	500	1	2.150
RF200150	90...150	160	250	500	1	2.150
RF200200	120...200	200	315	500	1	2.150

Independent screw fixing or direct mounting on contactors:
BF160-BF195-BF230 using RFX42035 links.
BF265-BF330-BF400 using RFX42036 links.

RF420250	150...250	250	400	800	1	2.460
RF420300	180...300	315	500	800	1	2.460
RF420420	250...420	500	630	800	1	2.460

NOTE: the appropriate adjustment range of the overload relay should be selected on the basis of the motor nameplate full-load current when direct, across the line starting is considered.

RELAYS FOR B500 AND B630 CONTACTORS

MANUAL OR AUTOMATIC RESETTING.

Consult Technical support for the relative order codes and detailed information; see contact details on inside front cover.

Three-phase IEC motor powers ①

230V	400V	500V	690V
[kW]	[kW]	[kW]	[kW]

18.5-25	33-51	45-63	59-92
22-37	40-63	55-80	75-110
25-45	51-80	63-100	92-140
37-59	75-100	92-140	129-184

45-75	92-132	110-162	140-220
55-92	100-162	129-198	180-280
75-110	129-198	180-280	250-368

NOTE: for 1000V powers, consult Technical support for information; see contact details on inside front cover.

① The indicated powers apply to 4-pole motors; it is advisable to always check that the nameplate motor current is within the relay adjustment.

Certifications and compliance

Certifications obtained:

Type	c U L u s	E A C
RF200	●	●
RF420	●	●

● Certified products.

cULus – UL Listed for USA and Canada (cULus - File E93601) as Auxiliary Devices – Thermal Overload Relays, 600VAC, open type, ambient compensated, 5000 Amps RMS symmetrical short circuit rating up to 150A FLA range, 10000 Amps RMS for 200A up to 300A FLA range and 18000 Amps for the 420A; the trip current is 120% FLA.

Compliant with standards: IEC/EN/BS 60947-1, IEC/EN/BS 60947-4-1, UL 60947-1, UL 60947-4-1, CSA C22.2 n° 60947-1, CSA C22.2 n° 60947-4-1.

3 Motor protection relays

Thermal overload relays.
For BF and B series contactors

**Non phase failure /
non single phase sensitive
Three poles (three phase)**



RFN200... - RFN420...

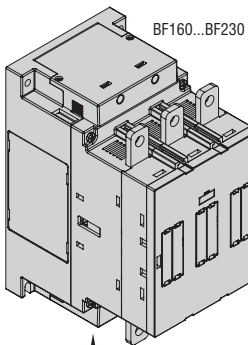

BF160...BF230

RFX20035
RFX42035

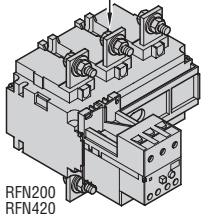

RFN200
RFN420

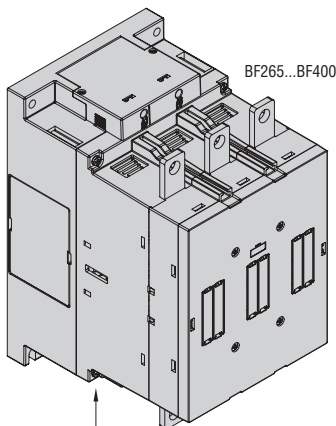

BF265...BF400

RFX20036
RFX42036

RFN200
RFN420

Order code	Adjustment range	Protection fuses IEC			Qty per pkg	Wt [kg]
		aM [A]	gG [A]	UL K5 [A]		
	[A]	[A]	[A]	[A]	n°	[kg]

MANUAL OR AUTOMATIC RESETTING.

Independent screw fixing or direct mounting on contactors:
BF160-BF195-BF230 using RFX20035 links.
BF265-BF330-BF400 using RFX20036 links.

RFN200100	60...100	100	160	500	1	2.150
RFN200125	75...125	125	200	500	1	2.150
RFN200150	90...150	160	250	500	1	2.150
RFN200200	120...200	200	315	500	1	2.150

Independent screw fixing or direct mounting on contactors:
BF160-BF195-BF230 using RFX42035 links.
BF265-BF330-BF400 using RFX42036 links.

RFN420250	150...250	250	400	800	1	2.460
RFN420300	180...300	315	500	800	1	2.460
RFN420420	250...420	500	630	800	1	2.460

NOTE: the appropriate adjustment range of the overload relay should be selected on the basis of the motor nameplate full-load current when direct, across the line starting is considered.

RELAYS FOR B500 AND B630 CONTACTORS.

MANUAL OR AUTOMATIC RESETTING.
Consult Technical support for the relative order codes and detailed information; see contact details on inside front cover.

Three-phase IEC motor powers

230V [kW]	400V [kW]	500V [kW]	690V [kW]
-----------	-----------	-----------	-----------

18.5-25	33-51	45-63	59-92
22-37	40-63	55-80	75-110
25-45	51-80	63-100	92-140
37-59	75-100	92-140	129-184

45-75	92-132	110-162	140-220
55-92	100-162	129-198	180-280
75-110	129-198	180-280	250-368

NOTE: for 1000V powers, consult Technical support for information; see contact details on inside front cover.

● The indicated powers apply to 4-pole motors; it is advisable to always check that the nameplate motor current is within the relay adjustment range.

Certifications and compliance

Certifications obtained:

Type	cULus	EAC
RFN200	●	●
RFN420	●	●

● Certified products.

cULus – UL Listed for USA and Canada (cULus - File E93601) as Auxiliary Devices – Thermal Overload Relays, 600VAC, open type, ambient compensated, 5000 Amps RMS symmetrical short circuit rating up to 150A FLA range, 10000 Amps RMS for 200A up to 300A FLA range and 18000 Amps for the 420A; the trip current is 120% FLA.

Compliant with standards: IEC/EN/BS 60947-1, IEC/EN/BS 60947-4-1, UL 60947-1, UL 60947-4-1, CSA C22.2 n° 60947-1, CSA C22.2 n° 60947-4-1.

3 Motor protection relays

Add-on blocks and accessories for thermal overload relays



RFX20035



RFX3802



RFX3803



11G363



RFX3804



11G228

Order code	For relay	Qty per pkg	Wt
		n°	[kg]

Set of links for direct contactor mounting.

RFX20035	RF...200 on BF160-BF195-BF230 contactor	1	0.250
RFX20036	RF...200 on BF265-BF330-BF400 contactor	1	0.360
RFX42035	RF...420 on BF160-BF195-BF230 contactor	1	0.313
RFX42036	RF...420 on BF265-BF330-BF400 contactor	1	0.500

Protection cover for thermal overload relay-contactor assembly.

RFX3802	RF38 on contactor BF09-BF12-BF18-BF25	10	0.014
RFX3803	RF38 on contactor BF26-BF32-BF38	10	0.014

Protection shrouds for power terminals.

BFX815	RF...200	6	0.026
BFX816	RF...420	6	0.046

Independent mounting.

Screw fixing or 35mm DIN rail (IEC/EN/BS 60715) mounting.

RFX3804	RF...38 and RFE45	5	0.082
11G270	RF...82 - RF...110	10	0.148

Electrical reset.

11G228	RF...9 - RF...82 - RF...110	5	0.072
--------	-----------------------------	---	-------

Sealing device.

RFX3801	RF...38 - RF...200 - RF...420	10	0.002
11G233	RF...9 - RF...82 - RF...110	1	0.006

- ① Code for a single terminal.
To protect all thermal overload relay terminals order 6 pcs.
N.B. The terminals equipped with the links for direct contactor mounting RFX200... and RFX420... don't accept the protection.
- ② Replace with voltage digit. Standard voltages are:
- AC 50/60Hz 24V / 48V / 110-125V / 220-240V / 380-415V.

Operational characteristics

ELECTRICAL RESET 11G228			
Control circuit voltage	AC (50/60Hz)	V	12...550
	Power consumption in AC	VA	300
Minimum reset time	ms		20
Terminals	Faston		6.3x0.8

NOTE: coils can remain supplied for a maximum interval of 500ms; 3 consecutive operations are allowed, followed by a 5 minute interval. Reset only if at least 1min has passed from overload tripping. It is recommended to use the wiring diagram on page 3-14.

INDEPENDENT MOUNTING

- Conductor cross section with one cable:

- 6...10mm² / AWG 8 for RFX3804
- 35mm² / AWG 2 for 11G270

- Tightening torque:

- 2...2.5Nm / 18...22lb.in for RFX3804
- 3.9Nm / 34lb.in for 11G270.

Certifications and compliance

Certifications obtained:

Type	cULus	CSA	EAC
G361-G363	—	●	●
G373-G376-RFX20035-RFX42035	—	●	●
11G270	●	—	●
RFX3804	●	—	●

● Certified products.

cULus – UL Listed for USA and Canada (cULus - File E93601) as Auxiliary Devices for thermal overload relays.

CSA – CSA certified for Canada only (File 54332) as Kits for industrial control equipment.

Compliant with standards: IEC/EN/BS 60947-1, IEC/EN/BS 60947-4-1, UL 60947-1, UL 60947-4-1, CSA C22.2 n° 60947-1, CSA C22.2 n° 60947-4-1.

Combinations

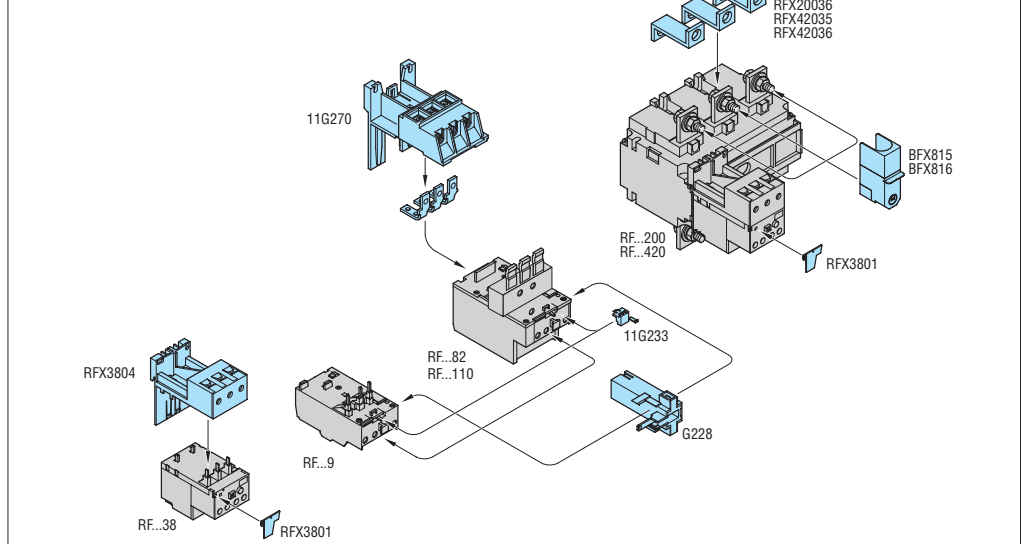

Protection cover for thermal overload relay-contactor assembly

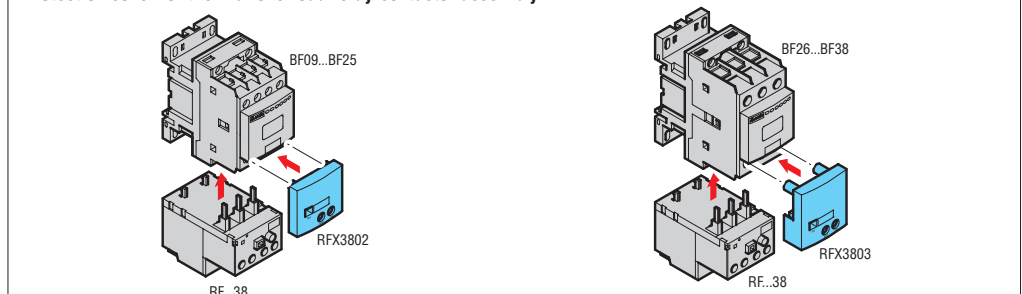

3 Motor protection relays

Electronic thermal overload relays.
For BF series contactors

**Phase failure /
single phase sensitive
Three poles (three phase)**



RFE45...

Order code	Adjustment range	Protection fuses IEC		Qty per pkg	Wt
	[A]	aM [A]	gG [A]	n°	[kg]

MANUAL OR AUTOMATIC RESETTING.
Direct mounting on BF09...BF38 contactors.
Independent mounting with RFX3804.

RFE450200	0.4...2	4	6	1	0.195
RFE450800	1.6...8	10	20	1	0.195
RFE453200	6.4...32	40	63	1	0.195
RFE454500	9...45	50	63	1	0.195

Three-phase IEC motor powers ①

230V	400V	500V	690V
[kW]	[kW]	[kW]	[kW]

0.09...0.37	0.12...0.75	0.18...0.75	0.25...1.1
0.37...0.55	0.75...3	1.1...4	1.1...5.5
1.5...7.5	3...15	6.8...28	5.5...30
3...11	4...22	5.5...30	7.5...45

① The indicated powers apply to 4-pole motors; it is advisable to always check that the nameplate motor current is within the relay adjustment range.

General characteristics

The RFE... electronic thermal overload relays for BF series contactors are characterized by a wide current adjustment range and high reliability and accuracy of tripping. They are self powered by the main circuit current and therefore do not require separate auxiliary supply voltage. RFE electronic thermal overload relays are suitable for all types of motor starting thanks to the possibility to select several tripping classes. A single front push button is used to select the reset function, manual or automatic, and to activate or deactivate the STOP function.

Operational characteristics

- IEC power circuit rated insulation voltage U_i : 690V
- IEC auxiliary circuit rated insulation voltage U_i : 690V
- rated impulse withstand voltage: 8kV
- rated frequency: 50/60Hz
- maximum rated current: 45A
- heat dissipation per phase: <1W
- selectable tripping classes: 5-10-20-30
- phase failure sensitive
- mounting position: Any
- sealable current adjuster and dip switches for tripping class selection
- degree of protection: IP20 on front.

Certifications and compliance

Certifications obtained: cULus.
Compliant with standards: IEC/EN/BS 60947-1;
IEC/EN/BS 60947-4-1, UL 60947-1, UL 60947-4-1,
CSA C22.2 n° 60947-1, CSA C22.2 n° 60947-4-1.

Thermistor protection relays



31DRPT...

Order code	Rated auxiliary supply voltage	Qty per pkg	Wt.
	[V]	n°	[kg]

DC supply (version for 35mm DIN rail IEC/EN/BS 60715).

31DRPTC24	24VDC	1	0.269
------------------	-------	---	-------

AC supply (version for 35mm DIN rail IEC/EN/BS 60715).

31DRPT24	24VAC	1	0.269
-----------------	-------	---	-------

31DRPT110	110VAC	1	0.269
------------------	--------	---	-------

31DRPT220	220...240VAC	1	0.269
------------------	--------------	---	-------

Accessories.

Order code	Description	Qty per pkg	Wt.
		n°	[kg]

31CE106	Adapter for screw fixing of DRPT relay on mounting plate.	10	0.008
----------------	---	----	-------

Galvanic isolation between supply and measuring circuits does not exist.

General characteristics

The DRPT is a thermal protection relay for motors equipped with thermistor PTC sensors immersed in the winding heads. The maximum number of thermistors to be used is limited by the resistance of all the sensors connected in series; total ohmic value is not to exceed 1.5kΩ at 25°C.

The DRPT type has fail-safe operation: the protective feature trips even in the case the PTC circuit is disconnected or there is a lack of voltage.

Resetting is manual or automatic.

Operational characteristics

- Supply circuit:
 - Rated frequency: 50-60Hz for AC types only
 - Operational limits: 0.85...1.1 Us
 - Maximum dissipation: 2.5W
 - Connection: Permanent
- Measuring circuit:
 - Type of connectable PTC sensor: According to DIN 44081
 - Total PTC resistance at 25°C: ≤1.5kΩ
 - Tripping resistance: 2.7...3.1kΩ
 - Resetting resistance: 1.5...1.8kΩ
 - Voltage at PTC terminals: ≤ 2.5VDC
- Remote resetting:
 - Control: NC contact opening
 - Contact voltage: 5VDC
 - Current consumption: About 1mA
- Relay output:
 - Arrangement: 1 relay with 2 changeover contacts
 - Rated operational voltage Ue: 250VAC
 - Conventional free air thermal current Ith: 5A
 - Designation to IEC/EN/BS 60947-5-1: B300
 - Mechanical life: 50x10⁶ cycles
 - Electrical life (with rated load): 2x10⁵ cycles
- Indications:
 - Green LED indicator for power ON
 - Red LED indicator for relay state TRIP
- Connections:
 - Conductor section 2x1.5mm² with ferrule (max)
 - Tightening torque: 0.8-1.2Nm
- Ambient conditions:
 - Operating temperature: -10...+60°C
 - Storage temperature: -30...+80°C
- Housing:
 - Snap on 35mm DIN rail (IEC/EN/BS 60715)
 - For screw fixing, use CE106 adapter
 - Degree of protection
 - IP40 housing
 - IP20 terminals.

Certifications and compliance

Certifications obtained: EAC.

Compliant with standards: IEC/EN/BS 60255-5.

THERMAL OVERLOAD RELAYS DIMENSIONS WITH CONTACTORS SEE ON CHAPTER 2

ACCESSORIES FOR THERMAL OVERLOAD RELAYS

RFX3804 base c/w RF...38 thermal relay

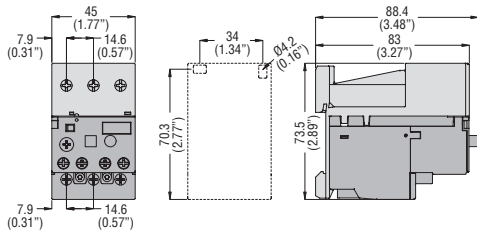

11G270 base c/w RF...82 and RF...110 thermal relay

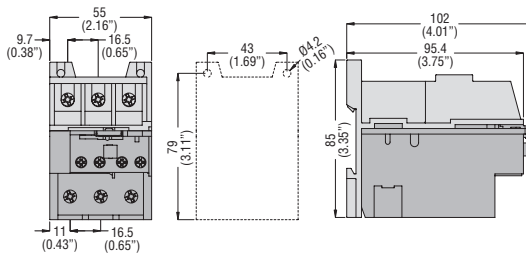

THERMAL RELAYS WITH LINKS

RF...200 with **RFX20035**, **11G372** and **11G373**

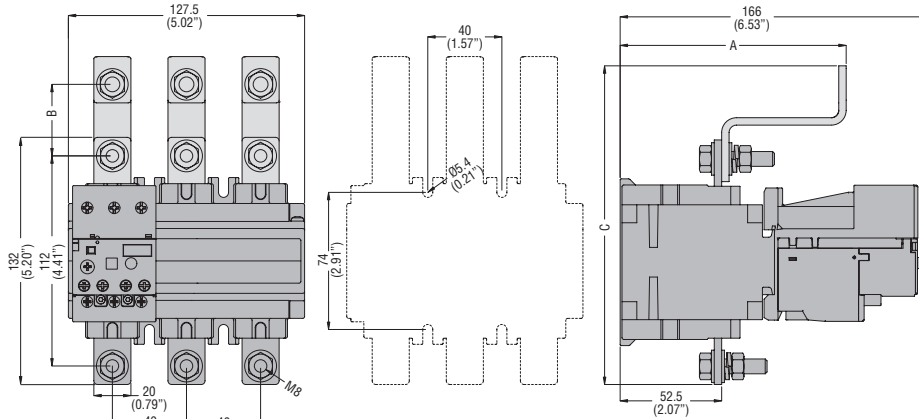

	A	B	C
RFX20035	120 (4.72")	40 (1.57")	174.5 (6.87")
RFX20036	146 (5.75")	45 (1.77")	179.5 (7.07")

RF...420 with **RFX42035**, **11G375** and **11G376**

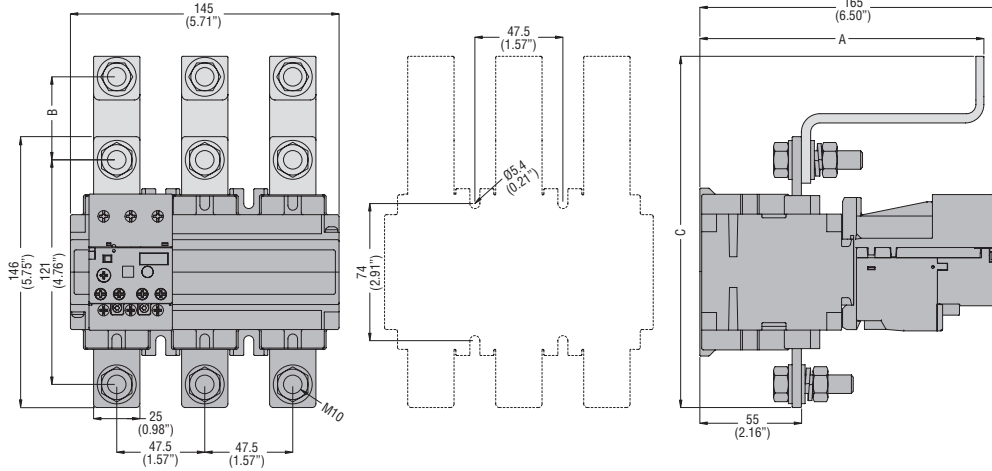

	A	B	C
RFX42035	122.5 (4.82")	45 (1.77")	191 (7.52")
RFX42036	148 (5.83")	45 (1.77")	191 (7.52")

ADD-ON BLOCKS FOR THERMAL OVERLOAD RELAYS

RF...9, RF...82 and RF...110

11G228... reset

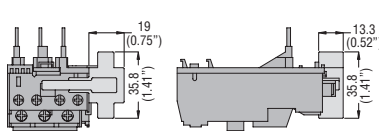

ELECTRONIC THERMAL OVERLOAD RELAYS

RFE45 with RFX3804

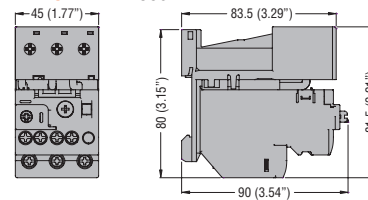

THERMISTOR PROTECTION RELAYS

DRPT

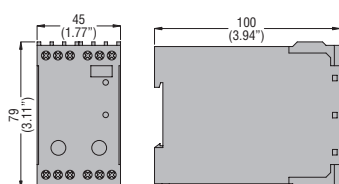

CE106 adapter

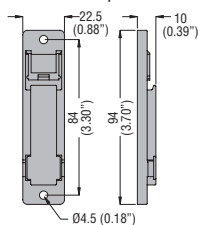

THERMAL OVERLOAD RELAYS FOR BG MINI-CONTACTORS

RF9 - RFN9

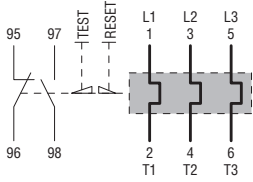

RFA9 - RFNA9

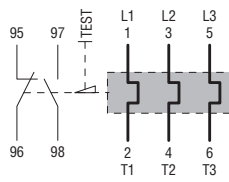

THERMAL OVERLOAD RELAYS FOR BF CONTACTORS

RF38 - RFN38

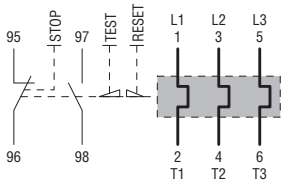

RF82 - RFN82 - RF110 - RFN110

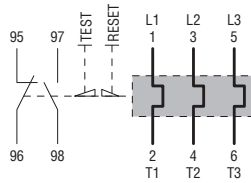

RFA82 - RFNA82 - RFA110 - RFNA110

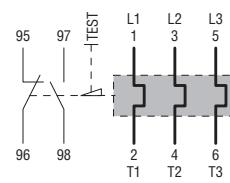

THERMAL OVERLOAD RELAYS FOR B CONTACTORS

RF200 - RFN200 RF420 - RFN420

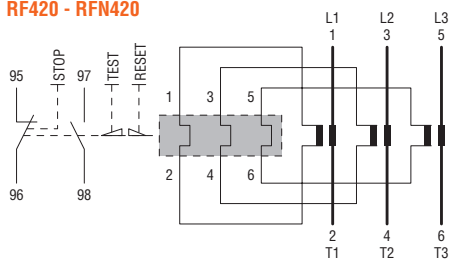

ADD-ON BLOCKS FOR THERMAL OVERLOAD RELAYS RF9 - RF82 - RF110

Electric reset **11G228**

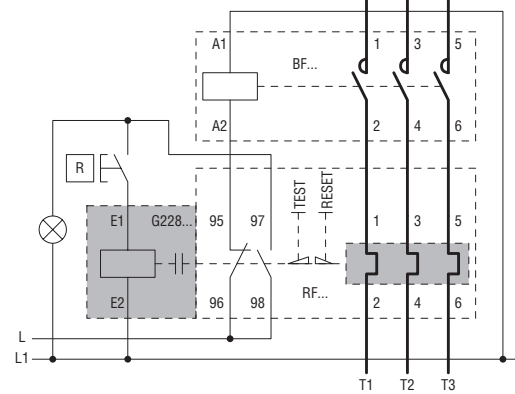

ELECTRONIC THERMAL OVERLOAD RELAYS

RFE45

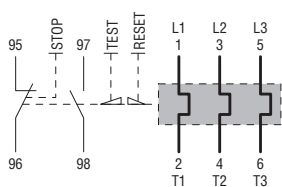

THERMISTOR PROTECTION RELAYS

DRPT

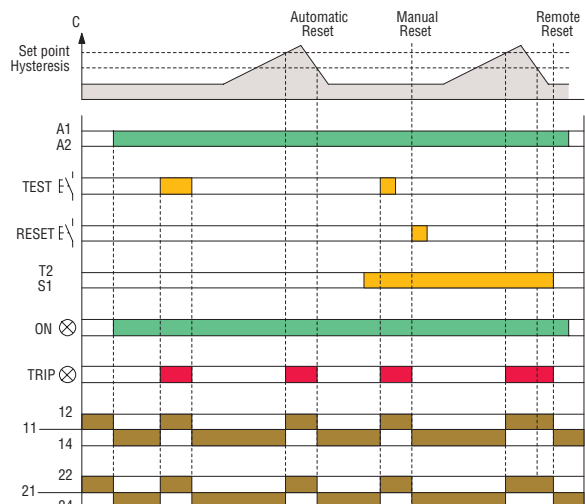
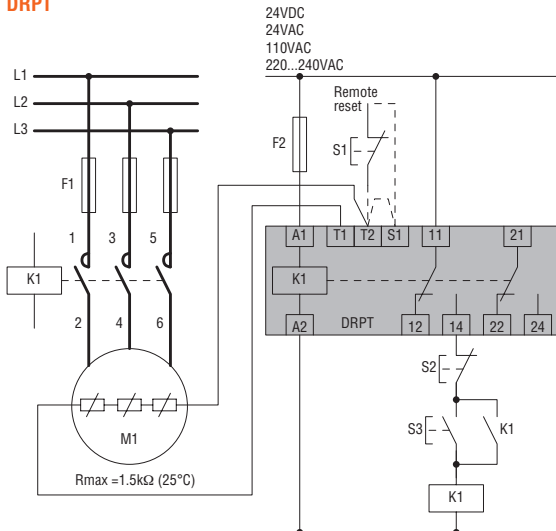

Phase failure/single phase sensitive manual reset	RF9	RF38①	RF82-RF110	RFE45	RF200①	RF420①
Phase failure sensitive automatic reset	RFA9	RFN38①	RFA82-RFA110		RFN200①	RFN420①
Non phase failure/non single phase sensitive manual reset	RFN9		RFN82-RFN110			
Non phase failure/non single phase sensitive automatic reset	RFNA9		RFNA82-RFNA110			

POWER CIRCUIT CHARACTERISTICS

IEC rated insulation voltage U_i	V	690	690	690	690	1000	1000		
IEC rated impulse withstand voltage U_{imp}	kV	8 ⑥	6	8 ⑥	6	6	6		
Frequency limit	Hz	0...400	0...400	0...400	50...60	50...60	50...60		
Operational range	from	A	0.09	0.1	20	60	0.4	60	150
	to	A	15	38	95	110	45	200	420 ②
Tripping class		10A			5-10-20-30		10A		
Particular characteristics		Test button - Trip indicator							
Connection		Direct			With current transformers ③				
Terminals	Type	Screw and washer		Yoke clamp	Screw and washer	Screw and flat washer			
	Screw	M4	M4	M5	M4	M8	M10		
	Terminal width	mm	9.8	12.6	9	12	20	25	
	Phillips	n°	2	2	2	2	13mm④	18mm④	
Tightening torque for power terminals	Nm	2.3	2...2.5	3.9	3.1	18	35		
	lb.in	20	14...18	34	28	159	310		
Maximum conductor section connectable	AWG	N°	10	8	2	6	--	--	
	Flexible w/o lug	mm²	6	10	35	16	--	--	
	Flexible c/w lug	mm²	10	6	--	10	150	2 x 150	
	Bar	mm	--	--	--	--	25 x 3	30 x 5	
Dissipation per phase	W	0.7...2.4	0.7...2.4	2.0...4.2	<1	0.7...2.4	0.7...2.4		

AUXILIARY CIRCUIT CHARACTERISTICS

Available contacts	NO	N°	1				
	NC	N°	1				
IEC rated insulation voltage	V	690					
IEC conventional free air thermal current I_{th}	A	10			5	10	
Terminals with screw and washer	Screw	M3.5					
	Terminal width	mm	8			7	8
	Phillips	n°	1	2	1	2	2
Maximum conductor section connectable	Flexible w/o lug	mm²	2.5				
	Flexible c/w lug	mm²	2.5				
Tightening torque for auxiliary terminals	Nm	1	0.8...1	1	0.8	0.8...1	0.8...1
	lb.in	8.8	9...13	8.8	9	9...13	9...13
UL/CSA and IEC/EN/BS 60947-5-1 designation		B600-P600 ⑤	B600-R300	B600-P600 ⑤	B600-R300	B600-R300	B600-R300

AMBIENT CONDITIONS

Operating temperature	°C	-20...+55	-25...+60	-20...+55	-25...+70	-25...+60	-25...+60
Storage temperature	°C	-55...+70	-50...+70	-55...+70	-55...+80	-50...+70	-50...+70
Compensation temperature	°C	-15...+55	-20...+60	-15...+55	-25...+70	-20...+60	-20...+60
Maximum altitude	m	3000					
Operation position	Normal	On vertical plane					
	Allowable	±30°					
Mounting		On contactor or separately					

- ① With manual and automatic resetting.
- ② For currents higher than 420A, consult Technical support for information; see contact details on inside front cover.
- ③ Standard supplied.
- ④ Metric wrench/spanner.
- ⑤ C600-R300 for automatic reset type.
- ⑥ 6kV for auxiliary terminals.

TRIP CHARACTERISTIC FOR RF THERMAL OVERLOAD RELAYS (AVERAGE TIME)
Three-phase balanced operation

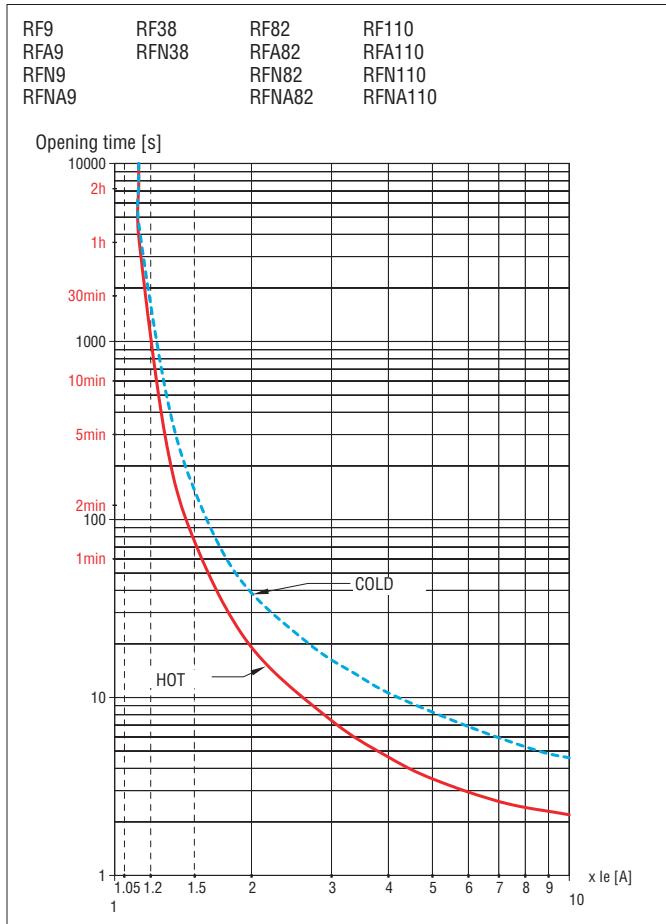

Two-phase operation (phase failure/single phase)

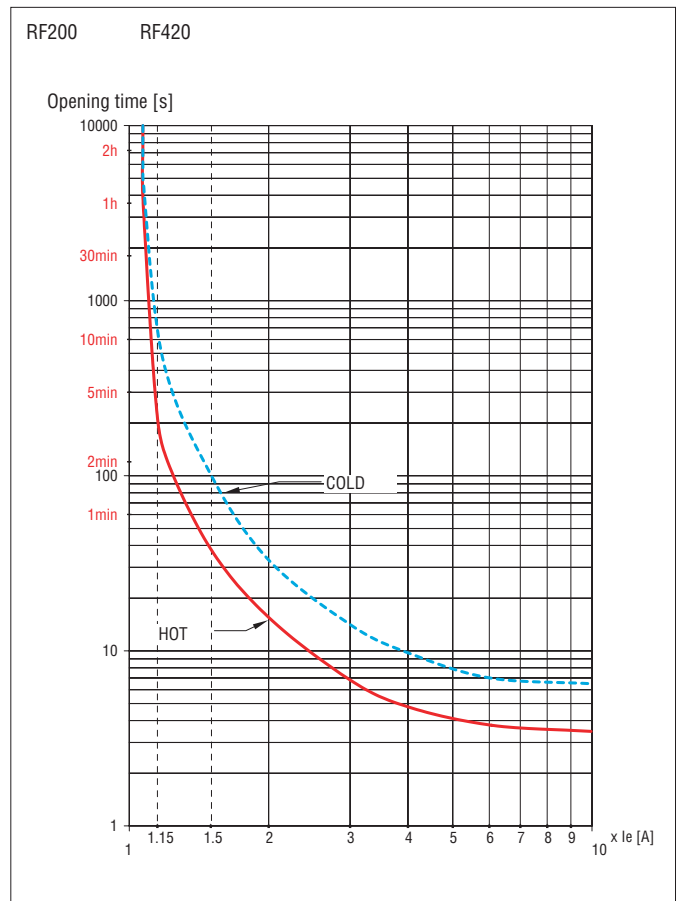
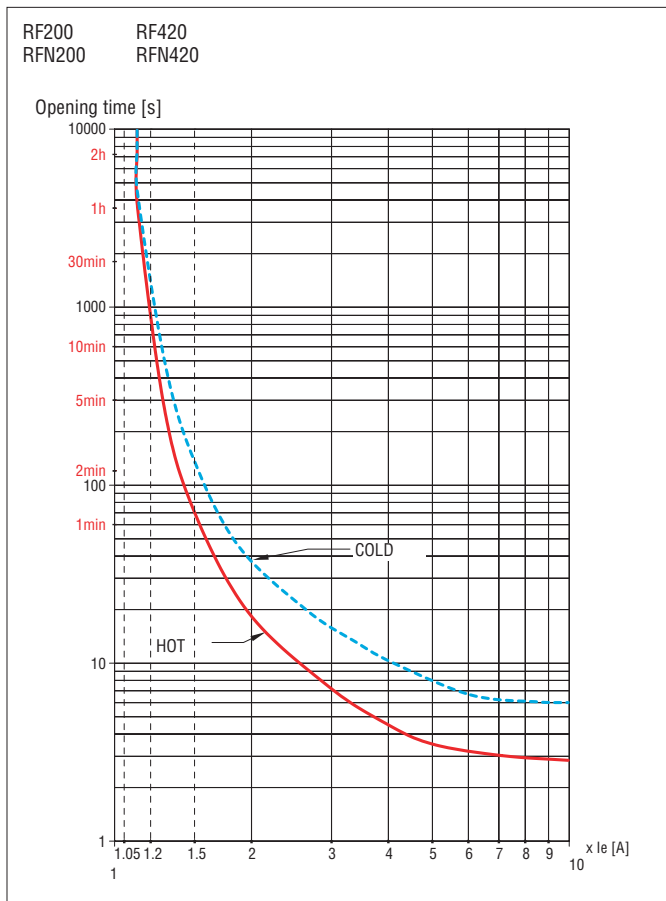
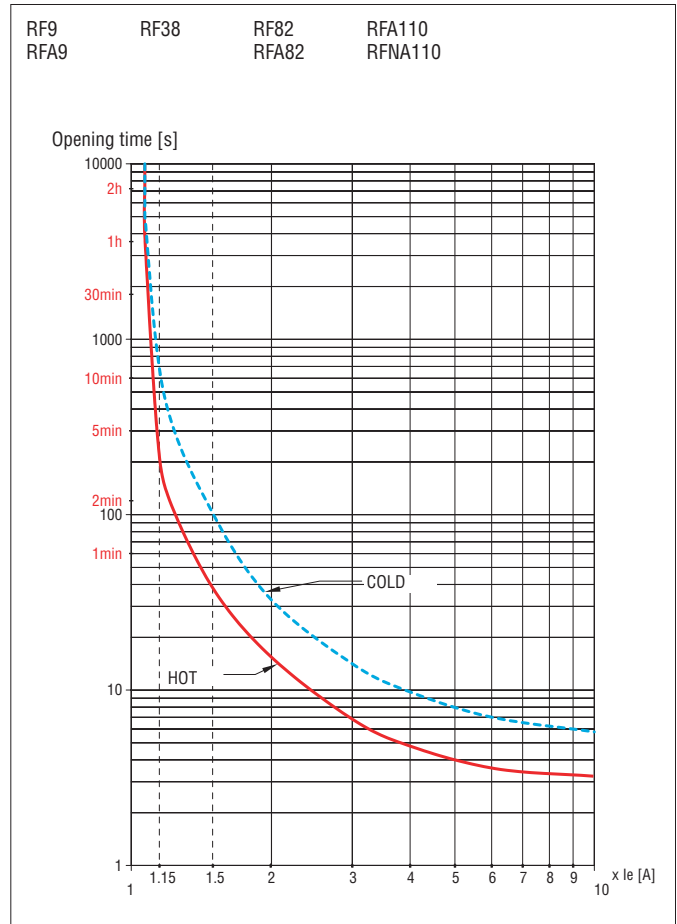

Tripping times can have a $\pm 20\%$ deviation with respect to the average tripping curve values above.

TRIP CHARACTERISTIC FOR RFE ELECTRONIC THERMAL OVERLOAD RELAYS
Three-phase balanced operation; class 5

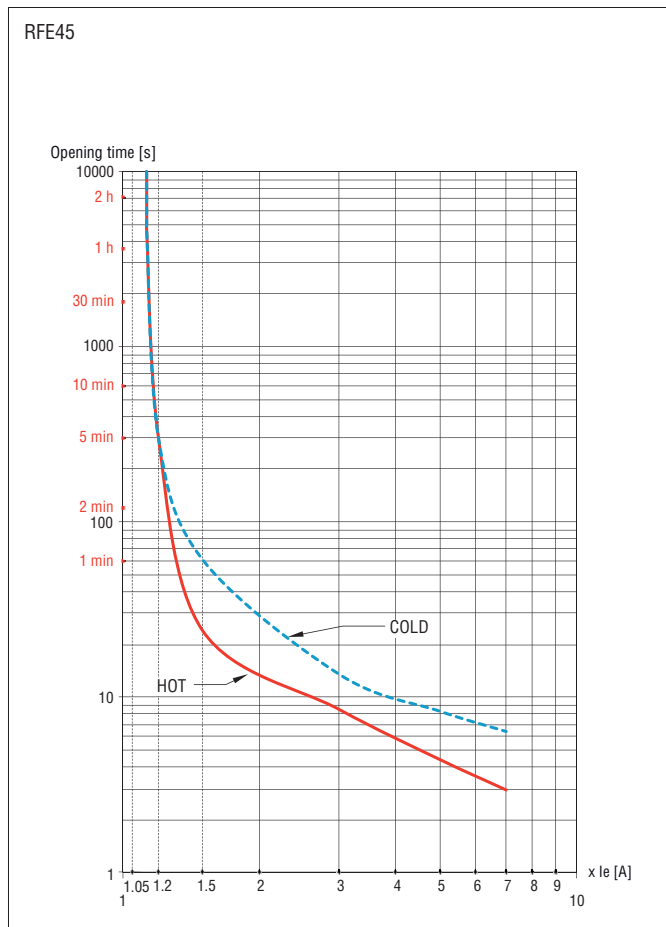

Three-phase balanced operation; class 20

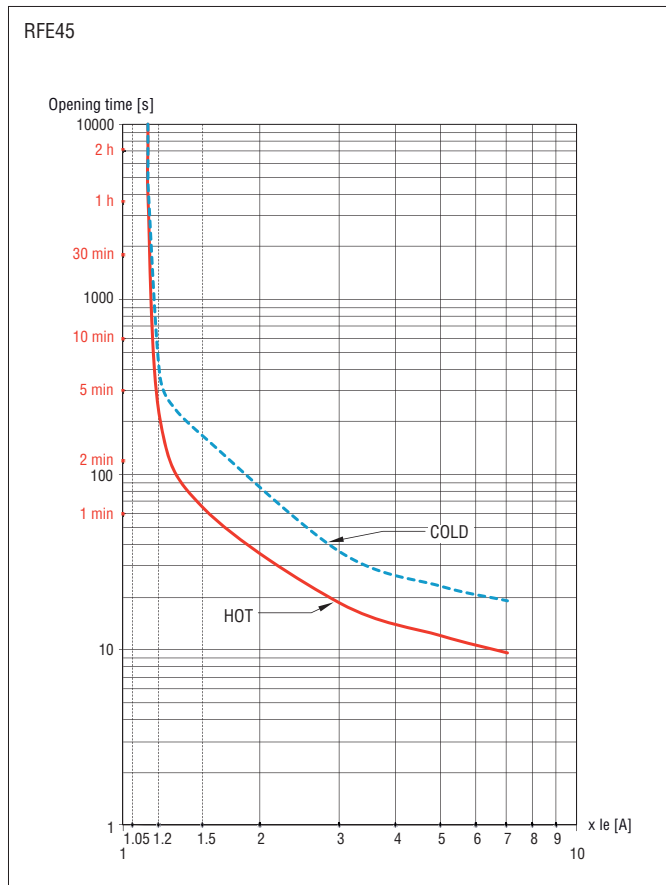

Note: with phase asymmetry >40% tripping in 3s max.

Three-phase balanced operation; class 10

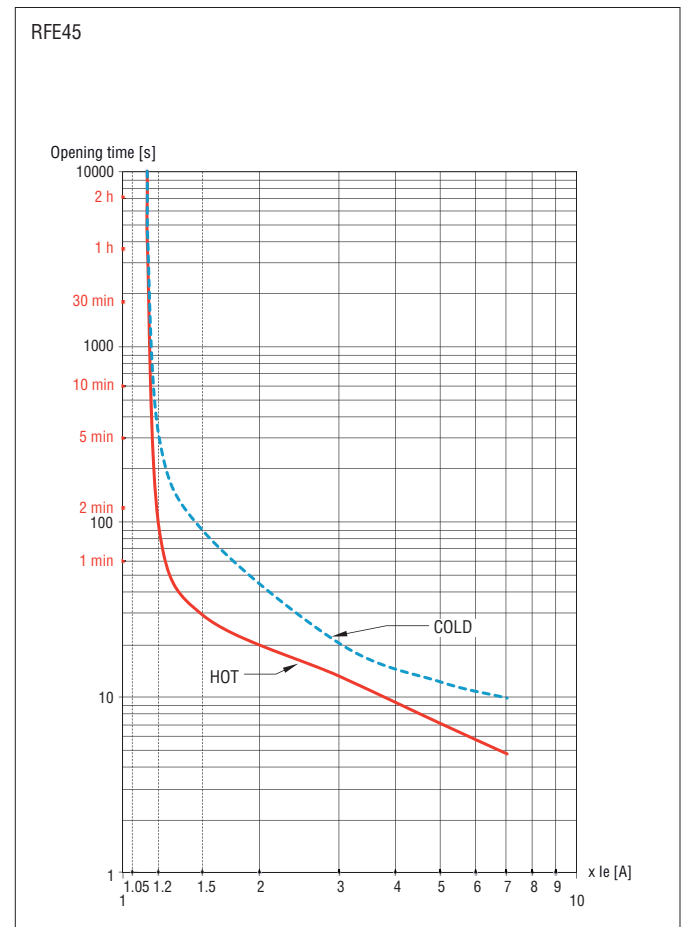

Three-phase balanced operation; class 30

