

Lovato
electric

LOVATO ELECTRIC S.P.A.

24020 GORLE (BERGAMO) ITALIA
VIA DON E. MAZZA, 12
TEL. 035 4282111
E-mail info@LovatoElectric.com
Web www.LovatoElectric.com



GB MICRO-PLC
Instructions manual



LRK...

WARNING!

- Carefully read the manual before the installation or use.
- This equipment is to be installed by qualified personnel, complying to current standards, to avoid damages or safety hazards.
- Before any maintenance operation on the device, remove all the voltages from measuring and supply inputs and short-circuit the CT input terminals.
- The manufacturer cannot be held responsible for electrical safety in case of improper use of the equipment.
- Products illustrated herein are subject to alteration and changes without prior notice. Technical data and descriptions in the documentation are accurate, to the best of our knowledge, but no liabilities for errors, omissions or contingencies arising there from are accepted.
- A circuit breaker must be included in the electrical installation of the building. It must be installed close by the equipment and within easy reach of the operator. It must be marked as the disconnecting device of the equipment: IEC / EN 61010-1 § 6.11.3.1.
- Clean the device with a soft dry cloth; do not use abrasives, liquid detergents or solvents.



ATTENTION !

- Lire attentivement le manuel avant toute utilisation et installation.
- Ces appareils doivent être installés par un personnel qualifié, conformément aux normes en vigueur en matière d'installations, afin d'éviter de causer des dommages à des personnes ou choses.
- Avant toute intervention sur l'instrument, mettre les entrées de mesure et d'alimentation hors tension et court-circuiter les transformateurs de courant.
- Le constructeur n'assume aucune responsabilité quant à la sécurité électrique en cas d'utilisation impropre du dispositif.
- Les produits décrits dans ce document sont susceptibles d'évoluer ou de subir des modifications à n'importe quel moment. Les descriptions et caractéristiques techniques du catalogue ne peuvent donc avoir aucune valeur contractuelle.
- Un interrupteur ou disjoncteur doit être inclus dans l'installation électrique du bâtiment. Celui-ci doit se trouver tout près de l'appareil et l'opérateur doit pouvoir y accéder facilement. Il doit être marqué comme le dispositif d'interruption de l'appareil : IEC/ EN 61010-1 § 6.11.3.1.
- Nettoyer l'appareil avec un chiffon doux, ne pas utiliser de produits abrasifs, détergents liquides ou solvants.



ACHTUNG!

- Dieses Handbuch vor Gebrauch und Installation aufmerksam lesen.
- Zur Vermeidung von Personen- und Sachschäden dürfen diese Geräte nur von qualifiziertem Fachpersonal und unter Befolgung der einschlägigen Vorschriften installiert werden.
- Vor jedem Eingriff am Instrument die Spannungszufuhr zu den Messeingängen trennen und die Stromwandler kurzschließen.
- Bei zweckwidrigem Gebrauch der Vorrichtung übernimmt der Hersteller keine Haftung für die elektrische Sicherheit.
- Die in dieser Broschüre beschriebenen Produkte können jederzeit weiterentwickelt und geändert werden. Die im Katalog enthaltenen Beschreibungen und Daten sind daher unverbindlich und ohne Gewähr.
- In die elektrische Anlage des Gebäudes ist ein Ausschalter oder Trennschalter einzubauen. Dieser muss sich in unmittelbarer Nähe des Geräts befinden und vom Bediener leicht zugänglich sein. Er muss als Trennvorrichtung für das Gerät gekennzeichnet sein: IEC/ EN 61010-1 § 6.11.3.1.
- Das Gerät mit einem weichen Tuch reinigen, keine Scheuermittel, Flüssigreiner oder Lösungsmittel verwenden.



ADVERTENCIA

- Leer atentamente el manual antes de instalar y utilizar el regulador.
- Este dispositivo debe ser instalado por personal cualificado conforme a la normativa de instalación vigente a fin de evitar daños personales o materiales.
- Antes de realizar cualquier operación en el dispositivo, desconectar la corriente de las entradas de alimentación y medida, y cortocircuitar los transformadores de corriente.
- El fabricante no se responsabilizará de la seguridad eléctrica en caso de que el dispositivo no se utilice de forma adecuada.
- Los productos descritos en este documento se pueden actualizar o modificar en cualquier momento. Por consiguiente, las descripciones y los datos técnicos aquí contenidos no tienen valor contractual.
- La instalación eléctrica del edificio debe disponer de un interruptor o disyuntor. Este debe encontrarse cerca del dispositivo, en un lugar al que el usuario pueda acceder con facilidad. Además, debe llevar el mismo marcado que el interruptor del dispositivo (IEC/ EN 61010-1 § 6.11.3.1).
- Limpiar el dispositivo con un trapo suave; no utilizar productos abrasivos, detergentes líquidos ni disolventes.



UPOZORNĚNÍ

- Návod se pozorně pročtěte, než začnete regulátor instalovat a používat.
- Tato zařízení smí instalovat kvalifikovaní pracovníci v souladu s platnými předpisy a normami pro předcházení úrazů osob či poškození věcí.
- Před jakýmkoli zásahem do přístroje odpojte měřící a napájecí vstupy od napětí a zkratujte transformátory proudu.
- Výrobce nenese odpovědnost za elektrickou bezpečnost v případě nevhodného používání regulátoru.
- Výrobky popsané v tomto dokumentu mohou kdykoli projít úpravami či dalším vývojem. Popisy a údaje uvedené v katalogu nemají proto žádnou smluvní hodnotu.
- Spínač či odpojovač je nutno zabudovat do elektrického rozvodu v budově. Musí být nainstalován v těsné blízkosti přístroje a snadno dostupné pracovníku obsluhy. Je nutno ho označit jako vypínači zařízení přístroje: IEC/ EN 61010-1 § 6.11.3.1.
- Přístroj čistěte měkkou utěrkou, nepoužívejte abrazivní produkty, tekutá čistidla či rozpouštědla.



AVVERTIZARE!

- Cititi cu atentie manualul înainte de a instala sau utiliza.
- Acest echipament va fi instalat de personal calificat, în conformitate cu standardele actuale, pentru a evita deteriorări sau pericole.
- Înainte de efectuarea oricărei operațiuni asupra dispozitivului, îndeplătiți toate tensiunile de la intrările de măsurare și de alimentare și scurtcircuitați bornele de intrare CT.
- Producătorul nu poate fi considerat responsabil pentru siguranța electrică în caz de utilizare incorectă a echipamentului.
- Produsele ilustrate în prezentul sunt supuse modificărilor și schimbărilor fără notificare anterioară. Datele tehnice și descrierile din documentație sunt precise, în măsura cunoștințelor noastre, dar nu se acceptă nicio răspundere pentru erorile, omisiunile sau evenimentele neprevăzute care apar ca urmare a acestora.
- Trebuie inclus un disjunctiv în instalația electrică a clădirii. Acesta trebuie instalat aproape de echipament și într-o zonă ușor accesibilă operatorului. Acesta trebuie marcat ca fiind dispozitivul de deconectare al echipamentului: IEC/EN 61010-1 § 6.11.3.1.
- Curățați instrumentul cu un material textil moale și uscat; nu utilizați substanțe abrazive, detergenți lichizi sau solvenți.



NOTE

Products illustrated herein are subject to alteration and changes without prior notice. Technical data and descriptions in the documentation are accurate, to the best of our knowledge, but no liabilities for errors, omissions or contingencies arising there from are accepted.

ATTENZIONE!

- Leggere attentamente il manuale prima dell'utilizzo e l'installazione.
- Questi apparecchi devono essere installati da personale qualificato, nel rispetto delle vigenti normative impiantistiche, allo scopo di evitare danni a persone o cose.
- Prima di qualsiasi intervento sullo strumento, togliere tensione dagli ingressi di misura e di alimentazione e cortocircuire i trasformatori di corrente.
- Il costruttore non si assume responsabilità in merito alla sicurezza elettrica in caso di utilizzo improprio del dispositivo.
- I prodotti descritti in questo documento sono suscettibili in qualsiasi momento di evoluzioni o di modifiche. Le descrizioni ed i dati a catalogo non possono pertanto avere alcun valore contrattuale.
- Un interruttore o disgiuntore va compreso nell'impianto elettrico dell'edificio. Esso deve trovarsi in stretta vicinanza dell'apparecchio ed essere facilmente raggiungibile da parte dell'operatore. Deve essere marchiato come il dispositivo di interruzione dell'apparecchio: IEC/ EN 61010-1 § 6.11.3.1.
- Pulire l'apparecchio con panno morbido, non usare prodotti abrasivi, detergenti liquidi o solventi.



UWAGA!

- Przed użyciem i instalacją urządzenia należy uważnie przeczytać niniejszą instrukcję.
- W celu uniknięcia obrażeń osób lub uszkodzenia mienia tego typu urządzenia muszą być instalowane przez wykwalifikowany personel, zgodnie z obowiązującymi przepisami.
- Przed rozpoczęciem jakichkolwiek prac na urządzeniu należy odłączyć napięcie od wejść pomiarowych i zasilania oraz zewrzeć zaciski przekładnicę mądowej.
- Producent nie przyjmuje na siebie odpowiedzialności za bezpieczeństwo elektryczne w przypadku niewłaściwego użytkowania urządzenia.
- Produkty opisane w niniejszym dokumencie mogą być w każdej chwili udoskonalone lub zmodyfikowane. Opisy oraz dane katalogowe nie mogą mieć w związku z tym żadnej wartości umownej.
- W instalacji elektrycznej budynku należy uwzględnić przełącznik lub wyłącznik automatyczny. Powinien on znajdować się w bliskim sąsiedztwie urządzenia i być łatwo osiągalny przez operatora. Musi być oznaczony jako urządzenie służące do wyłączenia urządzenia: IEC/ EN 61010-1 § 6.11.3.1.
- Urządzenie należy czyścić miękką szmatką, nie stosować środków czyszczących, płynnych detergentów lub rozpuszczalników.



警告!

- 安装或使用前，请仔细阅读本手册。
- 本设备只能由合格人员根据现行标准进行安装，以避免造成损坏或安全危害。
- 对设备进行任何维护操作前，请移除测量输入端和电源输入端的所有电压，并短接 CT 输入端。
- 制造商不负责因设备使用不当导致的电气安全问题。
- 此处说明的产品可能会有变更，恕不提前通知。我们竭力确保本文件中技术数据和说明的准确性，但对于错误、遗漏或由此产生的意外事件概不负责。
- 建筑电气系统中必须装有断路器。断路器必须安装在靠近设备且方便操作人员触及的地方。必须将断路器标记为设备的断开装置：IEC/EN 61010-1 § 6.11.3.1
- 请使用柔软的干布清洁设备；切勿使用研磨剂、洗涤剂或溶剂。



ПРЕДУПРЕЖДЕНИЕ!

- Прежде чем приступать к монтажу или эксплуатации устройства, внимательно ознакомьтесь с содержанием настоящего руководства.
- Во избежание травм или материального ущерба монтаж должен осуществляться только квалифицированным персоналом в соответствии с действующими нормативами.
- Перед проведением любых работ по техническому обслуживанию устройства необходимо обесточить все измерительные и питающие входные контакты, а также замкнуть накоротко входные контакты трансформатора тока (ТТ).
- Производитель не несет ответственность за обеспечение электробезопасности в случае ненадлежащего использования устройства.
- Изделия, описанные в настоящем документе, в любой момент могут подвергнуться изменению или усовершенствованию. Поэтому каталожные данные и описания не могут рассматриваться как действительные с точки зрения контрактов
- Электрическая сеть здания должна быть оснащена автоматическим выключателем, который должен быть расположен вблизи оборудования в пределах доступа оператора. Автоматический выключатель должен быть промаркирован как отключающее устройство оборудования: IEC/EN 61010-1 § 6.11.3.1.
- Очистку устройства производить с помощью мягкой сухой ткани, без применения абразивных материалов, жидких мощных средств или растворителей.



DIKKATI!

- Montaj ve kullanımdan önce bu el kitabını dikkatlice okuyunuz.
- Bu aparatlar kişilere veya nesnelere zarar verme ihtimaline karşı yürürlükte olan sistem kurma normlarına göre kalifiye personel tarafından monte edilmelidir
- Aparata (cihaz) herhangi bir müdahalede bulunmandan önce ölçüm girişlerindeki genilimi kesip akım transformatorlerinede kısa devre yaptırınız.
- Üretici aparatın hatalı kullanımından kaynaklanan elektriksel güvenliği ait sorumluluğu kabul etmez.
- Bu dokümanda tarif edilen ürünler her an evrimlere veya değişimlere açıktır. Bu sebeple katalogdaki tarif ve değerler herhangi bir bağlayıcı değeri haiz değildir.
- Binanın elektrik sisteminde bir anahtar veya şalter bulunmalıdır. Bu anahtar veya şalter operatörün kolaylıkla ulaşabileceği yakın bir yerde olmalıdır. Aparat (cihaz) devreden çıkarma görevi yapan bu anahtar veya şalterin markası: IEC/ EN 61010-1 § 6.11.3.1.
- Aparatı (cihaz) sıvı deterjan veya solvent kullanılarak yumuşak bir bez ile siliniz ardından temizlik ürünleri kullanmayınız.



UPOZORENJE!

- Prije instalacije ili korištenja uređaja, pažljivo pročitaite upute.
- Ovaj uređaj mora instalirati, u skladu s važećim normama, obučena osoba kako bi se izbjegle štete ili sigurnosne opasnosti.
- Prije bilo kakvog zahvata na uređaju otpojite napajanje s mjernih i napajajućih ulaza i kratko spojite ulazne stezaljke strujnog transformatora.
- Proizvođač ne snosi odgovornost za električnu sigurnost u slučaju nepravilnog korištenja opreme.
- Ovdje prikazan uređaj predmet je stalnog usavršavanja i promjena bez prethodne najave. Tehnički podaci i opisi u ovom uputama su točni, ali ne preuzimamo odgovornost za možebitne nenamjerne greške.
- U električnu instalaciju zgrade mora biti instaliran prekidač. On mora biti instaliran blizu uređaja i na dohvata ruke operatera, te označen kao rastavljač u skladu s normom IEC/EN/BS 61010-1 § 6.11.3.1.
- Uređaj čistite s mekom, suhom krpom bez primjene abraziva, tekućina, otapala ili deterdženta.



Contents	
Content	3
Chapter 1 Summary	4
Precautions for installation	5
Environmental requirements	5
LRK model explanation	6
Quick use instructions	6
Install LRXSW Programming Software	6
Connect the power	7
Connect programming cable	7
Configure the gateway	7
Establish communication	9
Write simple program	9
Chapter 2 Installation	12
General specifications	13
Type selection form	14
Installation and fixing	15
Wiring	17
12/24VDC input wiring	17
100~240V input wiring	18
Sensor input wiring	18
Relay output wiring	18
IO Link or remote IO Link (for LRK20RD024RS type only)	19
Indicator	19
Chapter 3 Programming Tool	20
PC programming software LRXSW	21
Install the software	21
Start screen	21
Ladder programming environment	21
FBD programming environment	36
LCD display and keys	39
Keys	39
Initial screen	40
Main menu screen	43
RTC summer time/winter time setting	46
System error display and action	49
Chapter 4 Parameter Transfer	50
Internal data type of LRK	51
Transfer of parameters out of range	52
Chapter 5 Ladder Programming Instructions	53
Basic Elements	54
Special Functional Instructions	57
Output Instructions	58
Analog Instructions	59
Timer Instructions	60
Counter Instructions	69
Real-time clock (RTC) Instructions	79
Analog Comparator Instructions	87
Filter Instructions	89
HMI Instructions	92
IO Link/Remote IO Instructions (for LRK20RD024RS type only)	94
MU (Modbus) Instructions (for LRK20RD024RS type only)	98
SHIFT Instructions	106
AQ Analog Output Instructions	107
AS (Addition and Subtraction) Instructions	109
MD (Multiplication and Division) Instructions	110
PID Instructions	111
MX (Multiplex Controller) Instructions	114
AR (Ramp Function Generator) Instructions	115
DR (Data Register) Instructions	119
Chapter 6 FBD Programming Instructions	121
FBD Coil	122
FBD Program Storage Space	123
Analog Coil	125
Analog input	125
Analog output	126
Coil Blocks	127
HMI graph block	128
IO Link graph block (for LRK20RD024RS type only)	129
SHIFT graph block	131

Logic Block Diagrams	132
AND logic block diagram	132
AND (EDGE) logic block diagram	132
NAND logic block diagram	133
NAND (EDGE) logic block diagram	133
OR logic block diagram	133
NOR logic block diagram	134
XOR logic block diagram	134
RS logic block diagram	134
NOT logic block diagram	135
Pulse logic block diagram	135
BOOLEAN logic block diagram	135
Functional Block Diagrams	136
Timer functional block diagram	137
General counter functional block diagram	146
High-speed counter functional block diagram (for DC type only)	152
RTC functional block diagram	155
Analog comparator functional block diagram	161
Filter functional block diagram	164
Addition and subtraction functional block diagram	166
Multiplication and division functional block diagram	167
PID functional block diagram	168
Multiplex controller (MX) functional block diagram	169
Ramp function generator (AR) functional block diagram	170
Data register (DR) functional block diagram	173
Modbus functional block diagram	174
Chapter 7 Hardware Specifications	180
General Specifications	181
Input Power Specifications (current consumption to be tested)	181
General type specifications	181
Schematic diagram of incoming power line:	182
Input Specifications	183
100~240VAC type	183
12/24VDC type 12 I/O	183
12/24VDC type 20 I/O	184
Output Specifications	184
Precautions for Output Terminal Connection	185
Relay life	185
Outline Drawing (unit: mm)	185
Chapter 8 Function Specification of LRK20RD024RS Type	186
Communication Specifications	187
Function Description	188
MU instructions (Modbus communication master function)	191
Modbus communication slave function	193
ModBus communication protocol	193
Chapter 9 Extended Module Instructions	195
Overview	196
Extended Digital IO Modules	198
Extended Analog Modules	202
Analog input module 4AI	202
Temperature input module 4PT	203
Analog output module 2AO	204
Extended Communication Module	206
Extended RS485 Modbus RTU module	206
Chapter 10 External Memory	208
User program reading and writing with SD card	209
Data logging and output (LOG function)	210
Card formatting	211
Configuration file reading	212
Chapter 11 Ethernet Communication Function	213
Overview	214
Device connection	214
LRXSW programming software connection	216
Extended device connection and network block configuration	216
Web server	218
Network communication between two LRK devices	220
Modbus TCP function/Modbus RTU over TCP function	223
E-mail transfer function	227
Chapter 12 Project transfer from LRD to LRK	229
Conversion of LRD program to use with LRK either already saved as a file or Read (uploaded) directly from LRD	230
Conversion of LRD programs to use with LRK already saved as a file	232

Chapter 1 Summary

Chapter 1 Summary	4
Precautions for installation	5
Environmental requirements	5
LRK model explanation	6
Quick use instructions	6
Install LRXSW Programming Software	6
Connect the power	7
Connect programming cable	7
Configure the gateway	7
Establish communication	9
Write simple program	9

PRECAUTION FOR INSTALLATION

This product is used in industrial premises, and indoor use.

For your safety, this manual for LRK micro-plcs provides [Danger], [Caution] and other symbols. Please pay attention to the safety precautions during handling, installation, running and inspection, and try to make it safer during LRK running.



WARNING: Personal injury or death may be caused by misuse.



CAUTION: Personal injury or mechanical system damage may be caused by misuse.

PRECAUTION FOR INSTALLATION



Do not use in an environment not allowed in the catalog and manual, as electric shock, fire, malfunction and other adverse circumstances may occur in an environment exposed to high temperature, moisture, dust, corrosive gas, vibration and impact.



Please install LRK according to the installation precautions herein to avoid falling, fault or malfunction of the programmable controller.



Please turn off the power before wiring, connection, installation (Battery extended modules) or movement, must be not operate with power.



The wiring method of external connection of terminal block is used for output end of LRK relay, where the connection is not covered and all externally-connected electronic parts are exposed; therefore, it is suggested that LRK and external parts be installed in a covered space or the dedicated distribution cabinet to avoid accidental contact.

PRECAUTIONS DURING WIRING



Be sure to make the third grounding according to electrotechnical regulations. No grounding or wrong grounding will lead to electric shock, malfunction and other faults.

Please follow the rated power specification for wiring. Inconsistent power specification will cause fire.



Wiring operation should be performed by the qualified electrician according to electrotechnical regulations.

Wrong wiring will lead to fire, electric shock, fault and other adverse situations

PRECAUTIONS DURING USE



Please use LRK according to the instruction manual, and perform safety confirmation of operation and wiring prior to running. Any misoperation may cause machine damage or personal injury.



Do not contact breakpoint or exposed parts after power-on, so as to avoid machine damage or personal injury.



Please install an emergency stop circuit, external interlock circuit and other wires for protection of the safety system to prevent machine damage caused by LRK fault.

PRECAUTIONS BEFORE INSTALLATION

Each LRK has passed test and inspection before delivery. Please verify as instructed below after opening the package.

- Check the model/ specification of LRK is consistent with the order.
- Check whether LRK is damaged during transportation. Do not power on LRK in case of any damage.

ENVIRONMENTAL REQUIREMENTS

The installation environment of LRK is vital, which may affect its function and service life. Please select the place of installation as required below:

- Vertical placement;
- Please use in dry environment;
- Ambient temperature: -20...+55°C (-4...+122°F);
- Keep LRK away from heating equipment;
- Avoid any place exposed to volatile oil gas, organic solvent, ammonia gas, electrolyte and other harmful gases;
- Avoid direct sunlight;
- Avoid corrosive and combustible gases;
- Avoid entry of dust, particles or metal filing;
- Avoid electromagnetic induction and interference;
- LRK must be installed in the control cabinet.
- Avoid vibration; please mount a damping device for LRK if vibration is inevitable.

DISCLAIMER

We have checked content of the manual to ensure consistency with LRK hardware and software. As it is impossible to completely rule out some varying factors, we do not guarantee full consistency between the manual and hardware and software. However, we have strictly checked the manual, including necessary content of subsequent upgrade version. We assume no liability for any losses caused by operation in violation of this manual.

LRK MODEL EXPLANATION

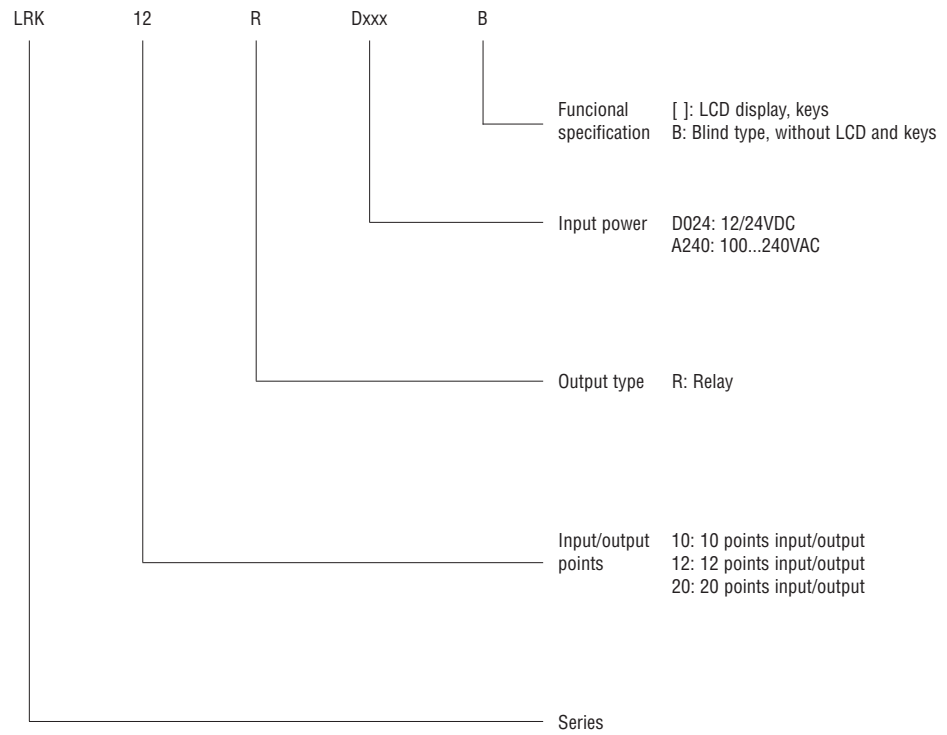

QUICK USE INSTRUCTIONS

This section provides instructions on how to connect, program and operate a LRK controller in 5 steps. This is not a complete programming instruction or an installation operation. Refer to other sections for other detailed procedures.

INSTALL LRXSW PROGRAMMING SOFTWARE

Download LRXSW programming software from the website www.lovatoelectric.com.

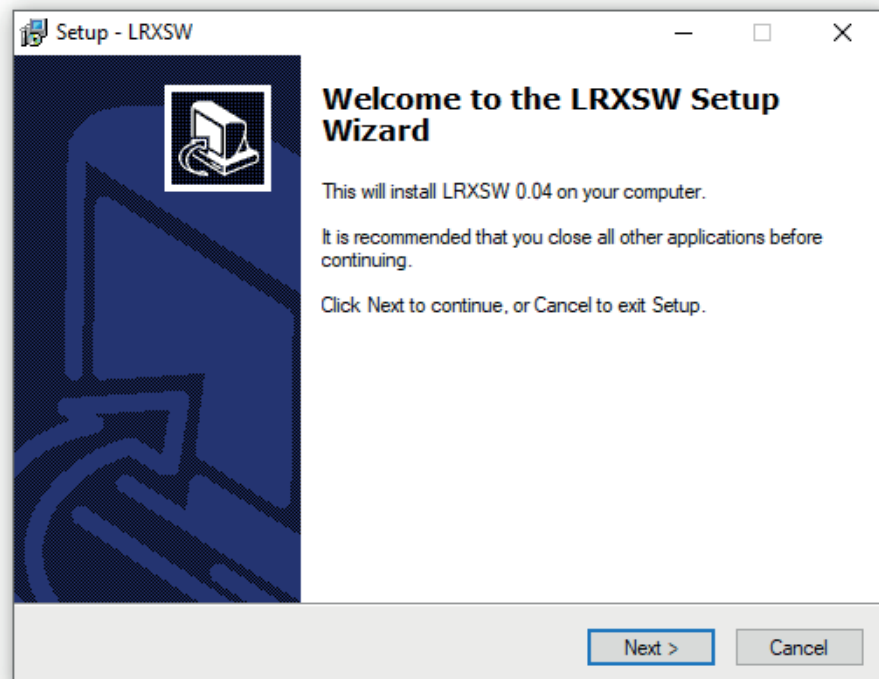

CONNECT THE POWER

Select a proper power supply for the module and connect LRK to the power source, as shown below; refer to "Chapter II: Installation" for the detailed installation and wiring methods.

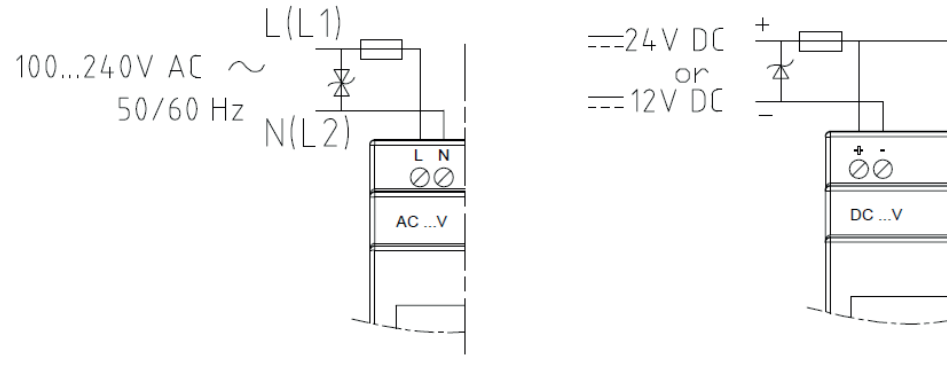

CONNECT PROGRAMMING CABLE

Insert the ethernet programming cable into the communication port of LRK, and connect the other cable end to network port of PC, as shown below.

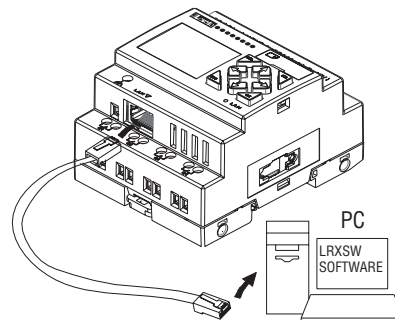

CONFIGURE THE GATEWAY

1. Configure LRK IP address

```

OUTPUT RECORD
FORMAT Card
> NETCONFIG
NET IO SET
  
```

```

> IP ADDRESS
SUBNET MASK
GETEWAY
MASTER IP
  
```

Move the cursor, choose "Network setting" and press "OK" for network configuration of LRK; set IP address, subnet mask and gateway address, move the cursor and press "OK" for network configuration of LRK.

Take IP address editing as an example: press "OK" to enter the editing interface, move the cursor to the last data bit, and press "SEL" to enter the editing mode.

IP ADDRESS

```
255.255.255.25█
```

IP ADDRESS

```
255.255.255.255
```

At this time, the cursor turns to "_" state; press Up/Down key for data editing, after completion of editing, press "ESC" to return to "NETCONFIG" menu.

After set all items ,press 'ESC' return to main menu and save all settings, LRK will power off and restart automatically.

The default maximum value of each field is 255, which is applied when the set value is greater than 255.

Example:

IP ADDRESS: 192.168.0.3

SUBNET MASK: 255.255.255.0

GATEWAY: 192.168.0.1

2. Configure IP address of PC side

Select "Attribute" option of local area connection, and choose Internet protocol version 4.

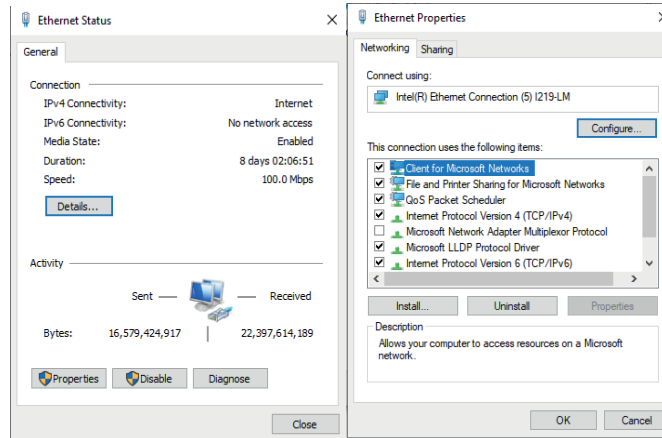

Configure IP address, Subnet mask and the default Gateway.

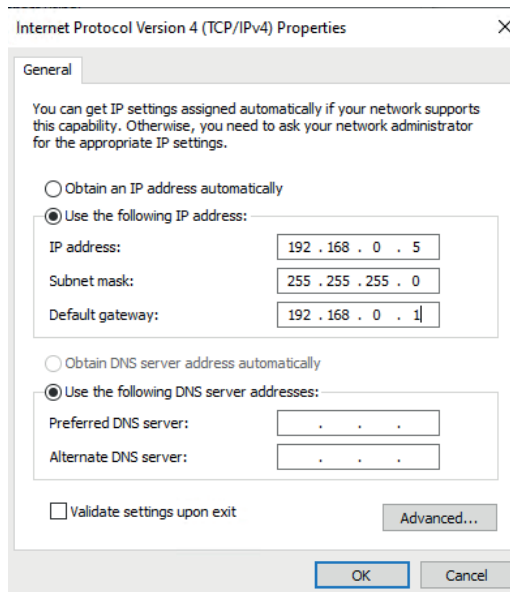

Example:

PC configurations:
 IP address: 192.168.0.5
 Subnet mask: 255.255.255.0
 Default gateway: 192.168.0.1

ESTABLISH COMMUNICATION

- Open the LRXSW programming software, and select "New", as shown in the left below;
- Click menu operation "Operation → Link", as shown in the right below;

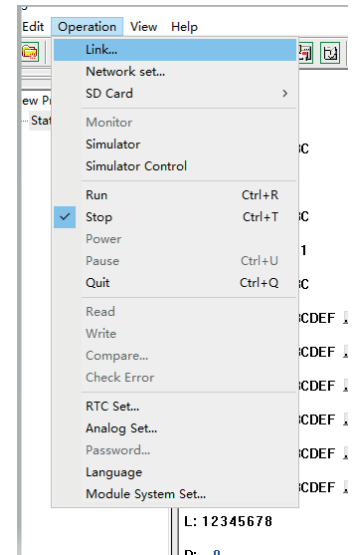
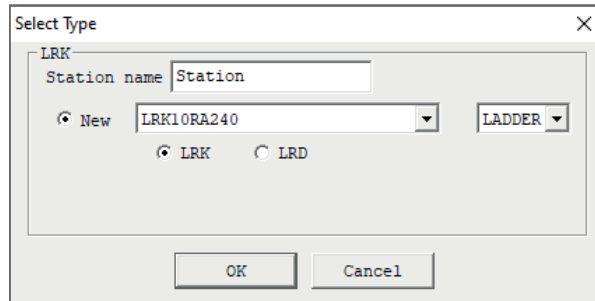

- Select TCP/IP of programming cable connection, and click "Link";

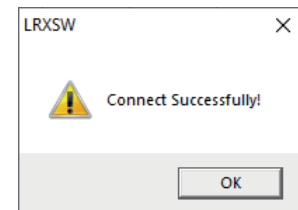
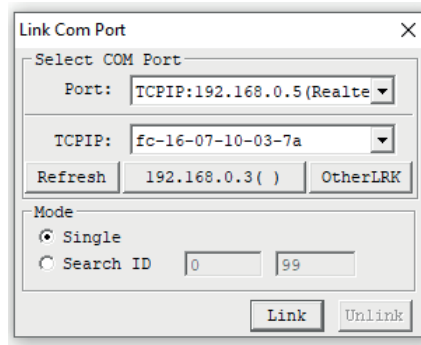

WRITE SIMPLE PROGRAM

- Write a simple program: Click on the far left of line 001 in the programming area, and then click the icon "M" in the Ladder toolbar, as shown below; select M01 and press OK. Refer to "Chapter IV: Ladder Programming Instructions" for the detailed programming method.

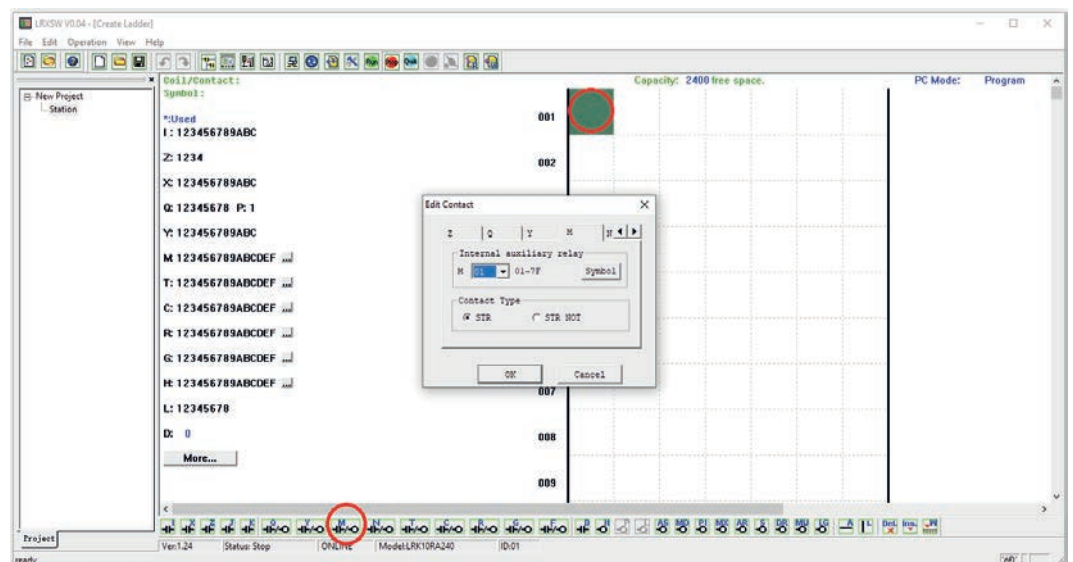

*Click "View/Ladder toolbar" on the menu if the Ladder toolbar is not displayed on the screen.

- b. Use the key “A” on the keyboard (or icon “A” in the Ladder toolbar) to draw a line from coil M to the rightmost unit of the programming area, as shown below.

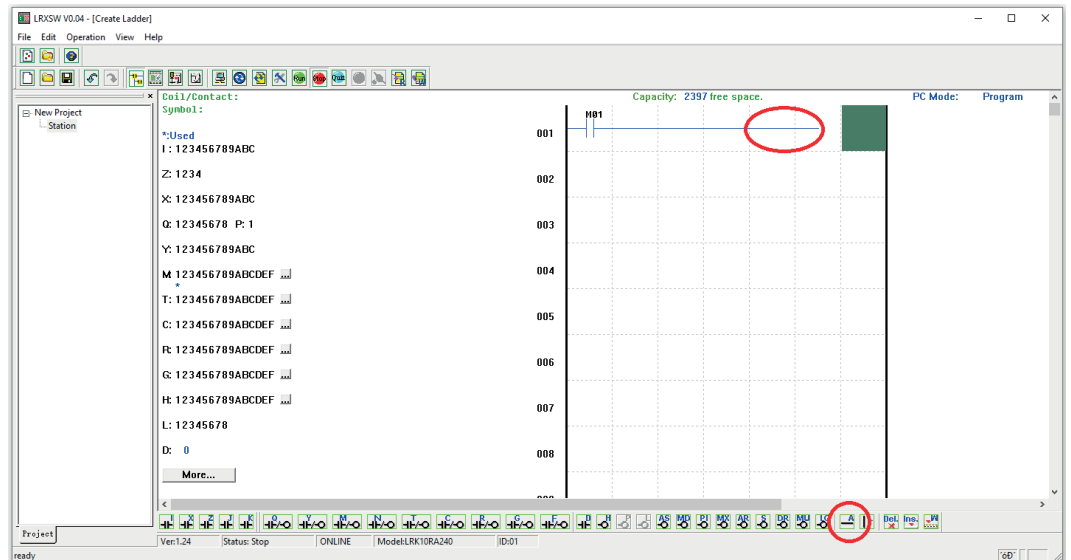

- c. Select icon “Q” in the Ladder toolbar, put it into the rightmost unit of the programming area, select Q01 in the dialog box and press OK, as shown below.

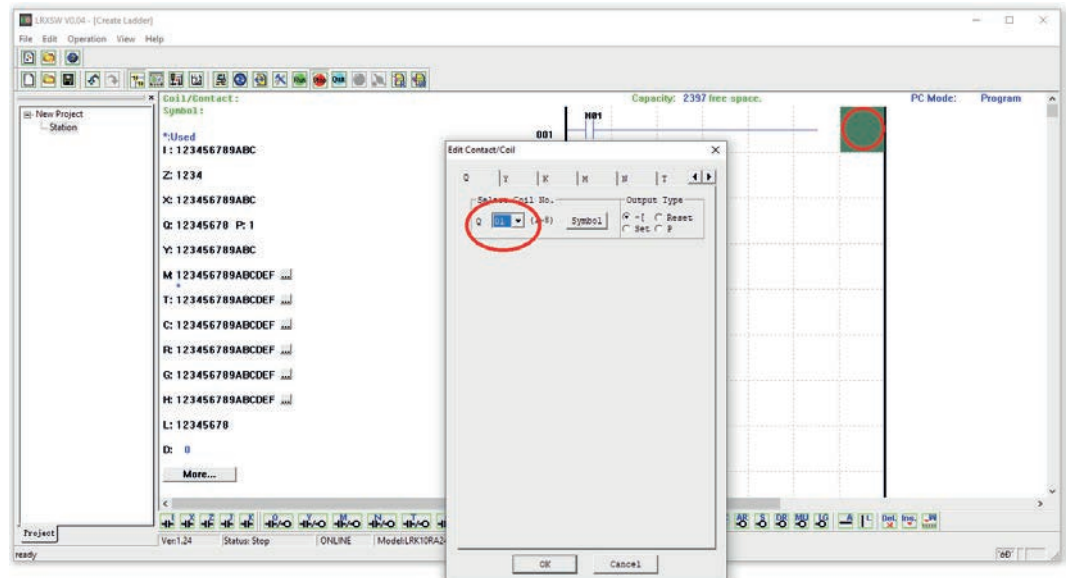

*Refer to “Chapter IV: Ladder Programming Instructions” for the detailed setting.

- d. Test the program: Select the menu operation “Operation—> Write”, as shown below, to write the sample program into LRK micro-plc.

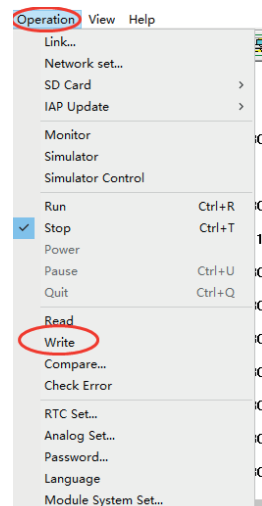

- e. Click the button “RUN” on the toolbar, when the system pops up the dialog box “Read program from the module?”; select “No” to control LRK running, as shown below.

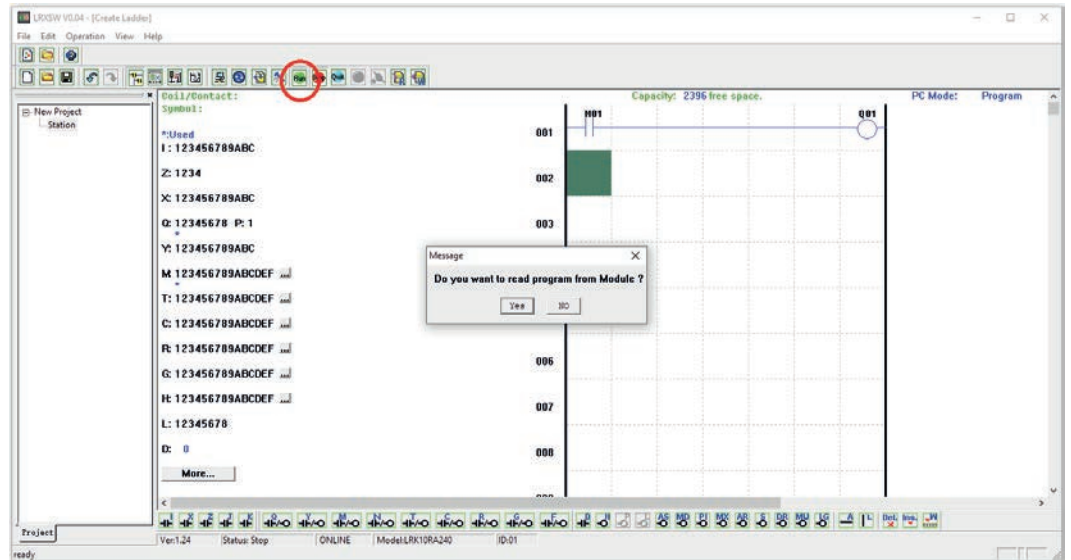

- f. Select the input status tool dialog, click coil M01 to make it ON, when output Q01 is enabled as ON, as shown below; the highlighted part is enabled, and output Q01 is ON. Refer to “Chapter III: Programming Tool” for more information about the programming software.

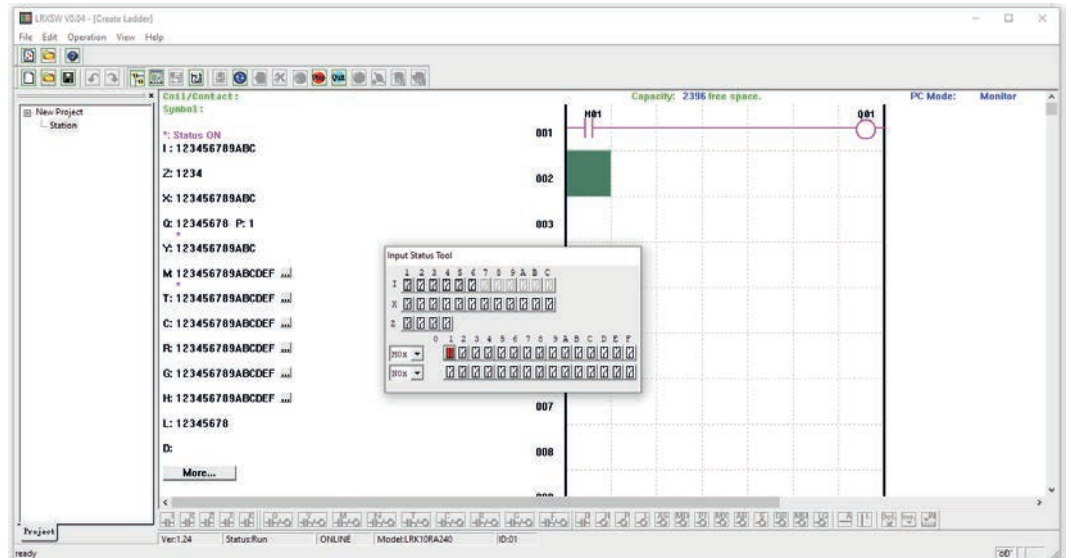

Chapter 2 Installation

Chapter 2 Installation	12
General specifications	13
Type selection form	14
Installation and fixing	15
Wiring	17
12/24VDC input wiring	17
100~240V input wiring	18
Sensor input wiring	18
Relay output wiring	18
IO Link or remote IO Link (for LRK20RD024RS type only)	19
Indicator	19

GENERAL SPECIFICATIONS

LRK is a powerful micro PLC with up to 44 input/output points. Itself up to 20 input/output points, 20 of which integrated on the base module (for the biggest type LRK20...) and up to 24 with expansion modules. It can be configured with 3 groups of 4-in 4-out I/O extended module, 2 groups of analog output module, 2 groups of analog input module and 1 group of communication module. Based on ladder diagram or FBD editing, it is applied to small-size automation.

LRK is flexible in use and has high performance. It can help you save considerable time and money.

Power supply	
Supply voltage range	DC type: 12/24VDC AC type: 100-240VAC
Average current	DC: 12 points: 300mA; 20 points: 400mA; 100-240VAC: 90mA;
Wire specification	14AWG /0.8NM

Programming	
Programming language	Ladder diagram (Ladder) /functional block diagram (FBD)
Programming space	600 lines under Ladder, 500 functional blocks under FBD
Program storage medium	Flash
Execution speed	5 msec/cycle
LCD display	4 lines x 16 characters
Timer	
Maximum number	Ladder: 31; FBD: 500
Timing range	0.01 s–9999 min
Counter	
Maximum number	Ladder: 31; FBD: 500
Maximum counting range	999999
Accuracy	1
RTC	
Maximum number	Ladder: 31; FBD: 500
Accuracy	1min
Effective time parameter	Week, year, month, day, hour, minute
Comparator	
Maximum number	Ladder: 31; FBD: 500
Comparator input	Current value of analog input, timer, counter, temperature input, analog output, analog input parameter, addition and subtraction, multiplication and division, PID control, multiplexing, ramp function generator, data register and other functional blocks

Operating environment	
Protection grade	IP20
Vibration resistance	IEC60068-2-6 0.075mm amplitude/1.0g acceleration
Operating temperature	-4° to 122°F (-20° to 50°C)
Storage temperature	-40° to 158°F (-40° to 70°C)
Operating humidity	90% RH, no condensation
Weight	8-point module 190g 10-point /12-point module 230g (type C 160g) 20-point module 345g (type C 250g)
Safety certification	CUL, CE, UL
OVC	OVC II
Pollution degree	PD2
Altitude	less than 2000m

Digital input	
Input current	3.2mA @12/24VDC 1.3mA@100-240VAC
Input OFF voltage	12/24VDC: < 5VDC 100-240VAC: < 40VAC
Input ON voltage	12VDC: >10VDC 24VDC: > 15VDC 100-240VAC: > 79VAC
Input ON delay	12/24VDC: 5ms 240VAC: 25ms 120VAC: 50ms
Input OFF delay	12/24VDC: 3ms 240VAC: 90/85ms 50/60Hz; 120VAC: 50/45ms 50/60Hz
Input characteristics	PNP, 3-wire
High-speed input frequency	10kHz
General input frequency	<40Hz
Protection	Reverse voltage protection required
Wire specification	14AWG/0.8NM
RS485 Wire specification	14AWG/0.8NM

Analog input	
Specification	DC host module: 12bits Extended analog input module: 12bits
Analog input range	DC host module: 0 10VDC voltage input Extended module: 0 10V voltage input or 0 20mA current input
Input signal OFF voltage	<5VDC (same with 24VDC type digital input)
Input signal ON voltage	>9.8VDC (same with 24VDC type digital input)
Isolation	None
Short-circuit protection	Provided
Analog input quantity	Host module: A1 A4 Extended module: A5 A8
Wire specification	14AWG/0.8NM
Relay output	
Contact medium	Ag Alloy
Current level	8A
Maximum load	Resistive load: 8A /point
Maximum response time	15ms (general condition)
Life	100k times of operation
Minimum load	16.7mA
Wire specification	14AWG/0.8NM
Power specification	0-240VAC

TYPE SELECTION FORM

Base modules

Model	Power supply	Inputs	Outputs	Display and keys	Ethernet port	RS485 port	Max I/O points
LRK12RD024	12/24VDC	6 DC, 2 Analog	4 relay	✓, Z01-Z04	✓	No	36 + 4*1
LRK12RD024B		6 DC, 2 Analog	4 relay	No	✓	No	36
LRK20RD024RS		8 DC, 4 Analog	8 relay	✓, Z01-Z04	✓	✓	44 + 4*1
LRK10RA240	100-240VAC	6 AC	8 relay	✓, Z01-Z04	✓	No	34 + 4*1

Expansion modules

Model	Power supply	Inputs	Outputs
LRE02AD024	24VDC	–	2 analog. type 0-10V/0-20mA
LRE04AD024	24VDC	4 analog. type 0-10V/0-20mA	–
LRE04PD024	24VDC	4, PT100 probes	–
LRE08RD024	24VDC	4 DC	4 relay
LRE08TD024	24VDC	4 DC	4 transistor
LRE08RA024	24VAC	4 AC	4 relay
LRE08RA240	100...240VAC	4 AC	4 relay
LREP00	24VDC	RS485 communication module, Modbus RTU	

* In case of standard module, there will be Keypad and LCD display, and the maximum I/O points may be increased by 4 points of Keypad input Z01~Z04.

* Refer to Chapter VI: Hardware Specification for details on the models.

* LRK is compatible with LRE modules.

INSTALLATION AND FIXING

DIN-rail fixing

LRK may be fixed directly with DIN-rail. After the mounting support in the back of LRK base module or expansion module is pulled out, the module can be fixed on the rail, and the extended module be connected to the host with expansion connector (press the button as shown below).

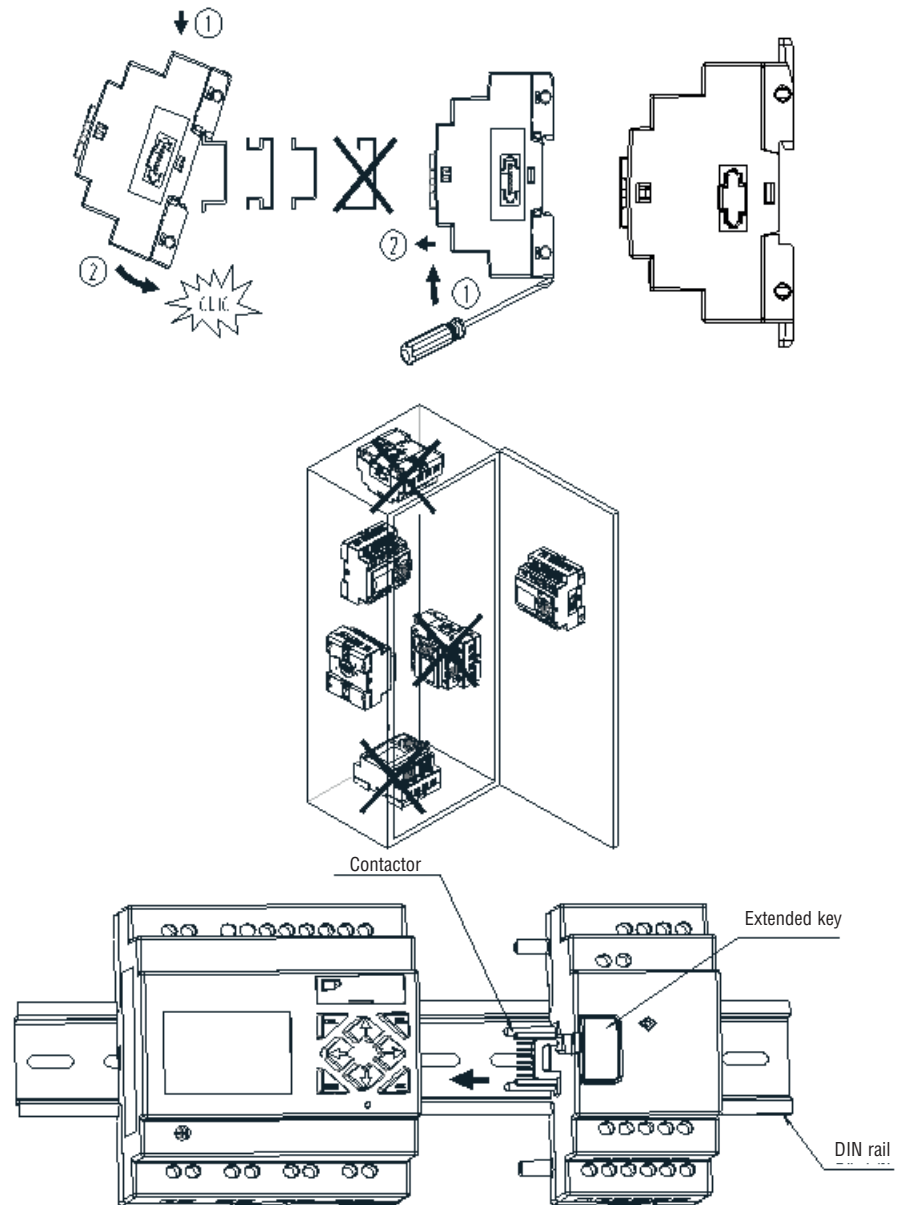

It is suggested that a clamp be mounted at the rail end to fix LRK on the rail (as shown below).

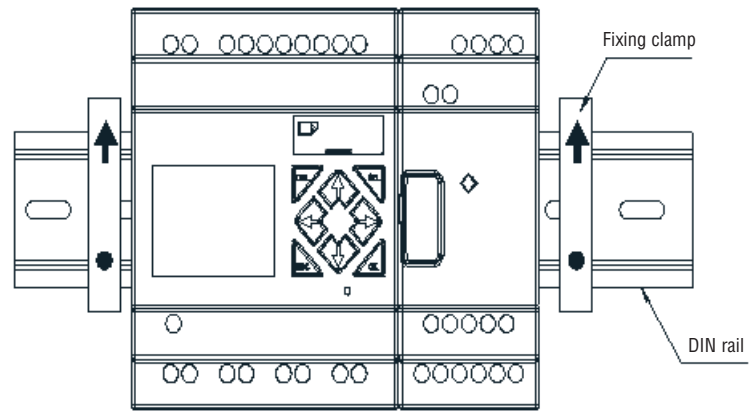

Direct fixing

Pull out the mounting support in the back of module, and use M4 screws for fixing LRK directly (as shown below). For installation of extended module, the module should be moved, connected with the host and fixed with screws after the host is properly fixed.

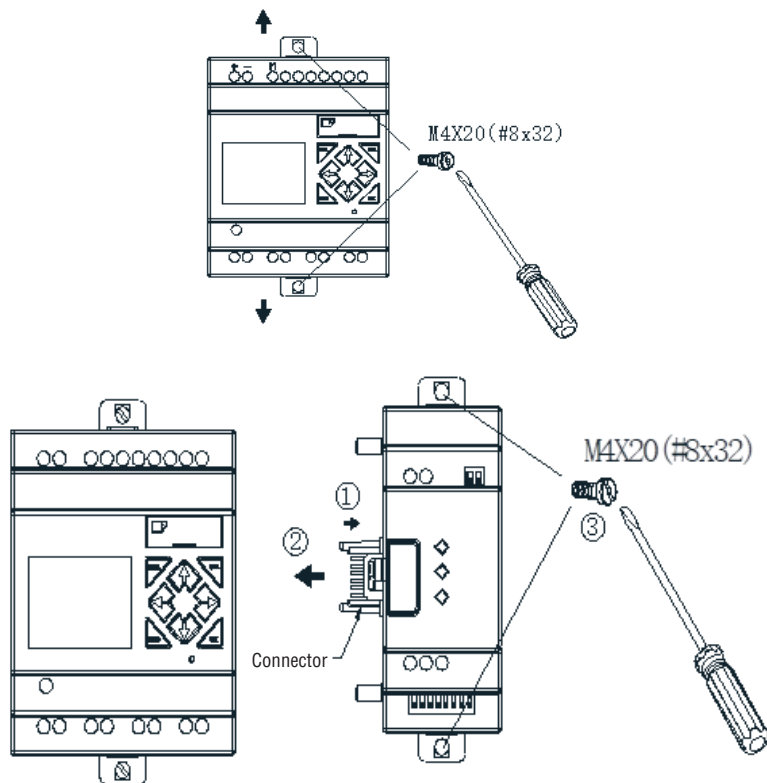

If the equipment is used in a manner not specified by the manufacturer, the protection provided by the equipment may be impaired.

WIRING



Output/input signal wire should not be parallel to high-voltage power line or placed in the same duct with such line.



It is suggested that fast acting fuse or circuit protector be connected in each output section to avoid short circuit.



Power and Signal cables should be selected by the following conditions:
Use Copper Conductors Only, And minimum temperature rating of the cable to be connected to the field wiring terminals, 105°C.

WIRE SIZE AND TERMINAL TORQUE

mm ²	0.14...1.5	0.14...0.75	0.14...2.5	0.14...2.5	0.14...1.5
AWG	26...16	26...18	26...14	26...14	26...16

 Ø3.5 (0.14in)	 C	Nm	0.6
		lbin	5.4

12/24VDC INPUT WIRING

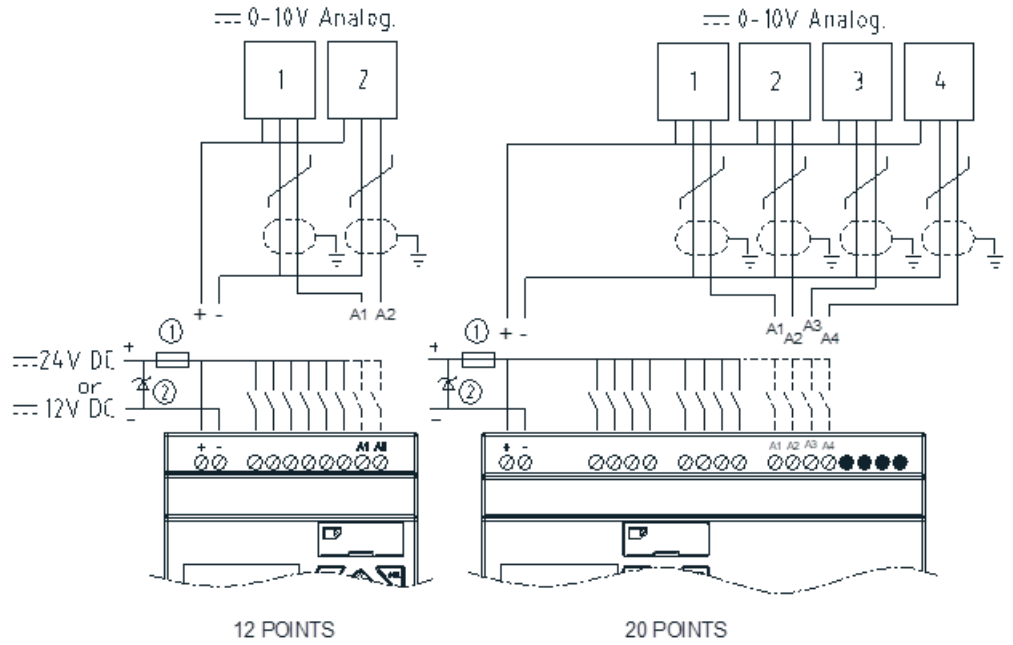

100-240VAC INPUT WIRING

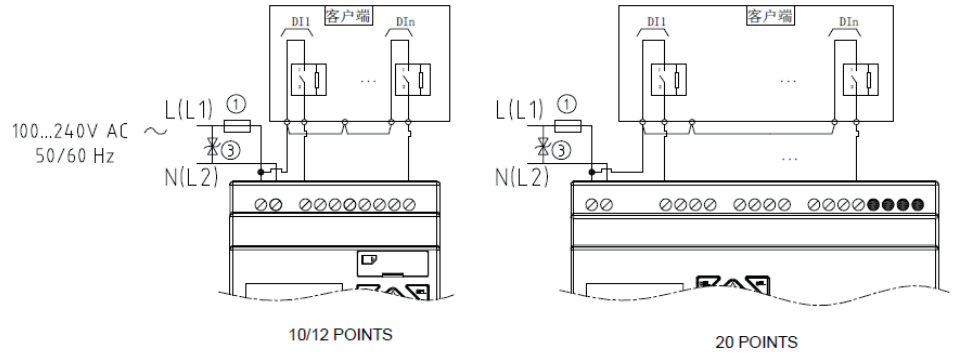

SENSOR INPUT WIRING

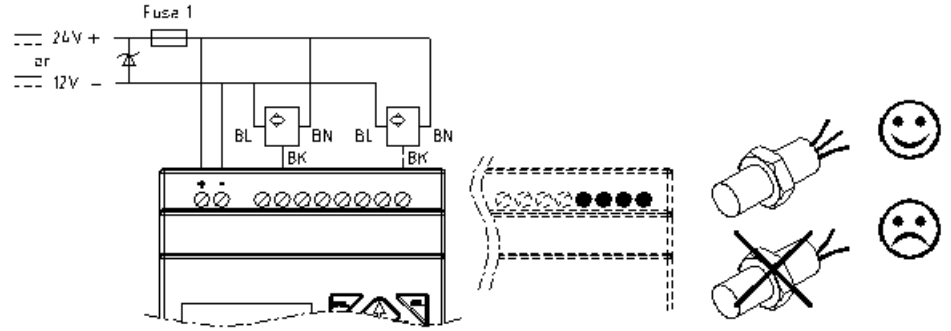

RELAY OUTPUT WIRING

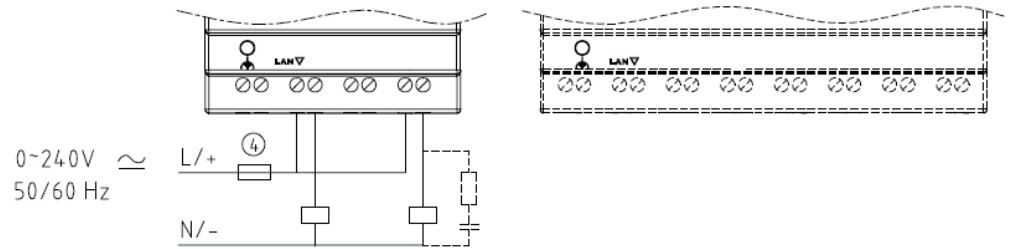

IO LINK OR REMOTE IO LINK (FOR LRK20RD024RS TYPE ONLY)

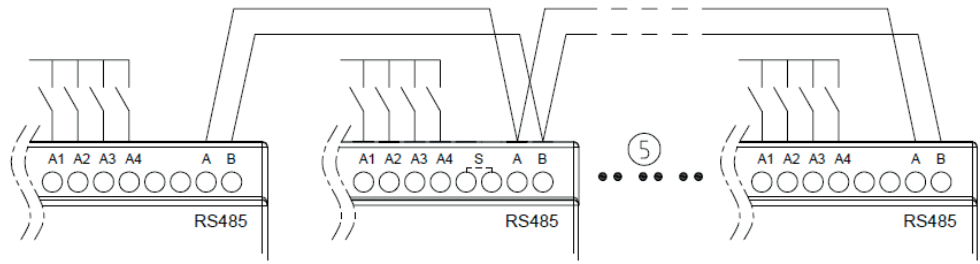

Common ground is provided for LRK power supply and I/O port inside.

When used as IO Link, it can be connected to 8 micro-plc type LRK20RD024RS (ID: 0~7) at most. When used as Remote I/O, it can be connected to 2 machines (host & slave) at most.

* Refer to Chapter VIII: Functional Specification of LRK20RD024RS Type for details of RS485 type.

- ① -1A fast acting fuse
- ② - Surge absorber (43VDC)
- ③ - Surge absorber (input 100~240VAC: 430VAC)
- ④ - Fuse
- ⑤ - Applicable standard: EIA RS-485;

Fuse description

When using LRK, fuse must be prepared by customer. Fuse category is JDDZ,1A.CLASS CC.

Battery installation instructions

LRK has battery installation slot on the back, the factory machine does not install batteries, customers need to install according to the need. The battery model is CR1220.



To avoid explosion or fire, install the correct type of battery.

INDICATOR

Micro-plc type LRK...B integrates a LED status indicator, status description of which in different running modes is provided below:

Status	Description
Green normally on	LRK is in standby state after power-on
Green blinking	LRK is in running state
Red blinking	RTC error
Red normally on	System program error Brown-out circuit error User program not available Logic error of FBD program Extended I/O error

Chapter 3 Programming Tool

Chapter 3 Programming Tool	20
PC programming software LRXSW	21
Install the software	21
Start screen	21
Ladder programming environment	21
Menu, icon and status display	22
Programming	22
Simulation mode	23
Establish the connection	24
Write program	24
Online monitoring	25
Run menu	25
HMI/TEXT	26
Program comment	29
AQ analog output setting	31
3-column input/5-column input	32
DR data register setting	33
View menu	35
FBD programming environment	36
Menu, icon and status bar	36
Programming	36
Simulation mode	37
Online monitoring	38
Program comment and parameter list	38
LCD display and keys	39
Keys	39
Initial screen	40
Main menu screen	43
RTC summer time/winter time setting	46
System error display and action	49

PC PROGRAMMING SOFTWARE LRXSW

The programming software LRXSW has two editing modes: Ladder diagram (Ladder) and functional block diagram (FBD). LRXSW is characterized as below:

1. Program can be established and edited simply and easily;
2. Program can be saved in PC and reused, or directly uploaded from LRK for saving or editing;
3. Program can be printed for reference;
4. LRK program can be tested in the simulation mode while it is not downloaded;
5. IO state can be monitored on a real-time basis or changed forcibly while LRK is in the running mode.

INSTALL THE SOFTWARE

The programming software LRXSW can be downloaded from the website www.lovatoelectric.com.

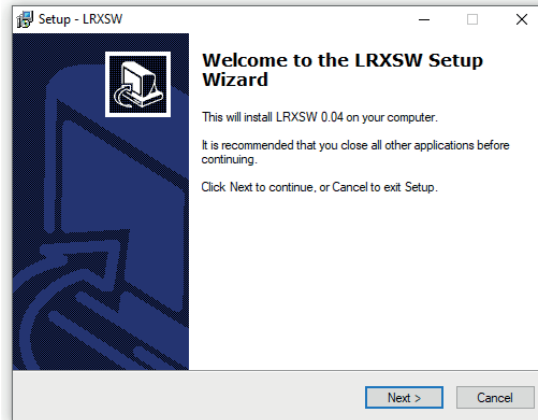

START SCREEN

Start the software LRXSW. when the start screen below appears to enable the following operations:

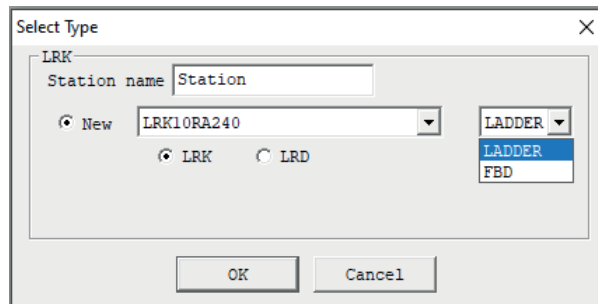

Create ladder diagram

Select the menu "File (F) -> New (N) -> ladder", and enter a new ladder diagram (Ladder) program editing environment.

Create FBD

Select the menu "File (F) -> New (N) -> FBD", and enter a new functional block diagram (FBD) program editing environment.

Open an existing file

Select the menu "File (F) -> Open (O)", choose a file (FBD or Ladder type) to be opened, select the file name and click to open it.

LADDER PROGRAMMING ENVIRONMENT

The Ladder programming environment includes all programming and simulation functions. Select the menu "File (F) -> New (N)", choose the Ladder mode and LRK type, set the number of extended connections, and select the corresponding LRK version (as shown below) to begin new programming.

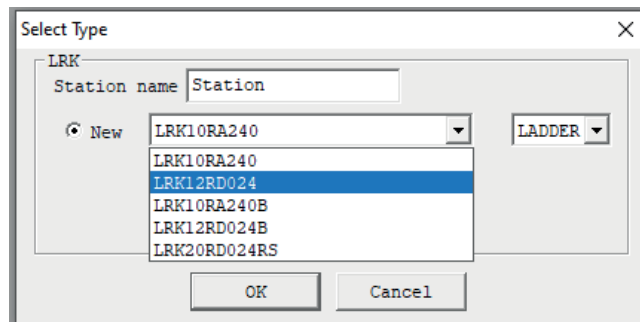

MENU, ICON AND STATUS DISPLAY

Ladder programming environment includes the following menu, icon and status display.

1. Menu bar: 5 menu options, including File, Edit, Operation, View and Help; for LRK communication setting, special functions, display setting, help information and other functions are configured.
2. Tool bar: The icons from left to right are:
Creating a new project, opening an existing project, saving the project and printing the project; Keypad, LADDER programming interface, HMI/Text editing, symbol (comment) editing;
Monitoring, simulation, simulation control, change of control mode (run, stop, quit), reading program from LRK, writing program to LRK.
3. List of used resources: The resources used by the current program are listed, and marked with "*" below each used coil or functional block;
4. Free space available for the program;
5. Current mode display: Programming mode, simulation mode and monitoring mode;
6. Ladder tool bar: Coil and functional block instructions can be selected for editing;
7. Status bar: It shows LRK status information of the current program and connection.

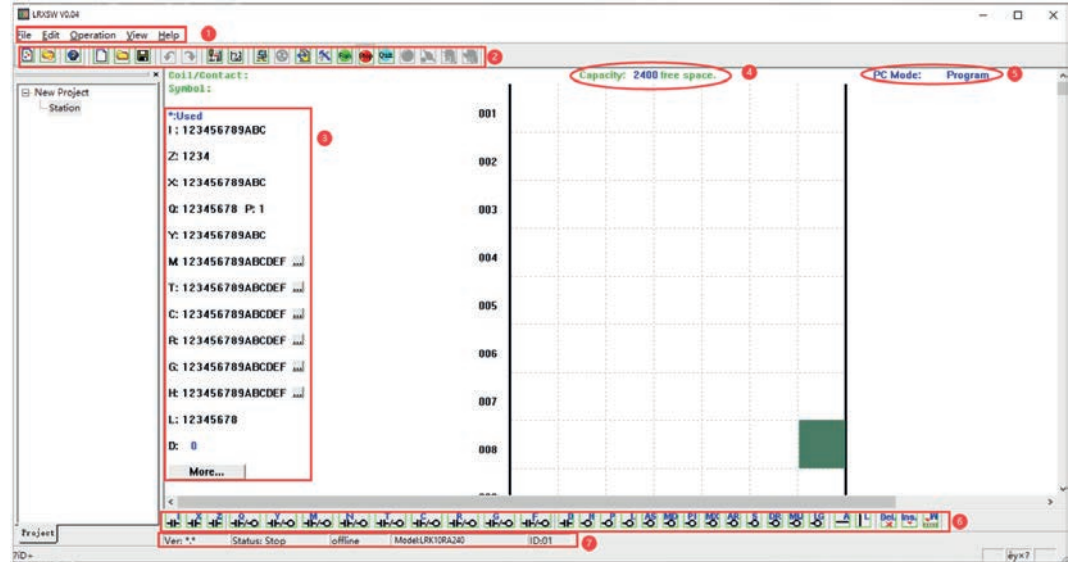

PROGRAMMING

The icon can be clicked or keys on the keyboard be used for programming with LRXSW. The program instructions are illustrated below.

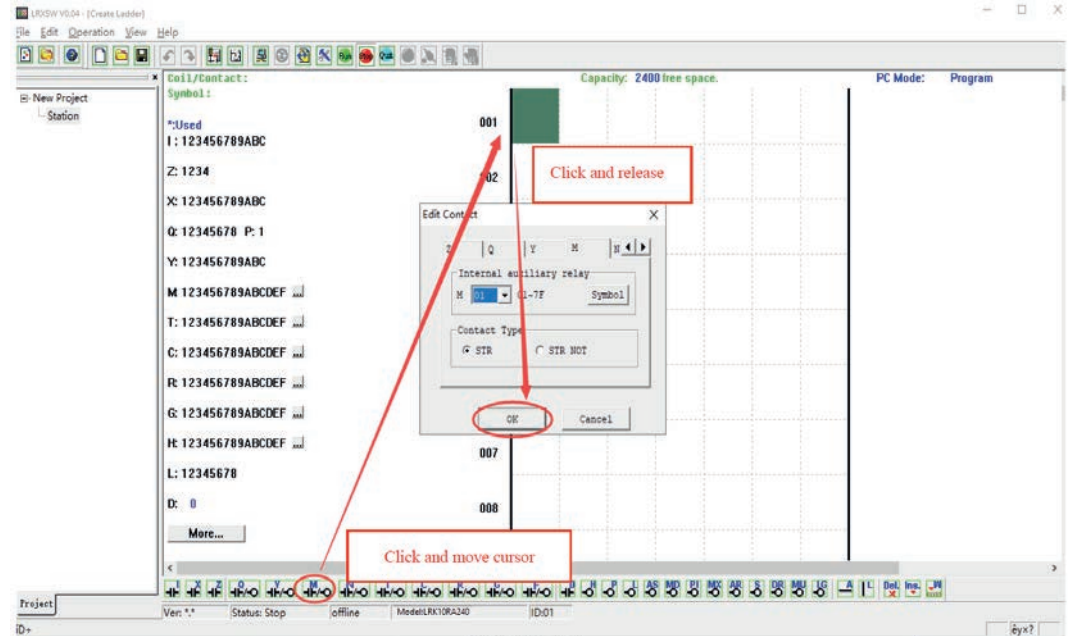

Use the key or symbol "A" and "L", and connect various coils; the rightmost is the programming column of output coil.

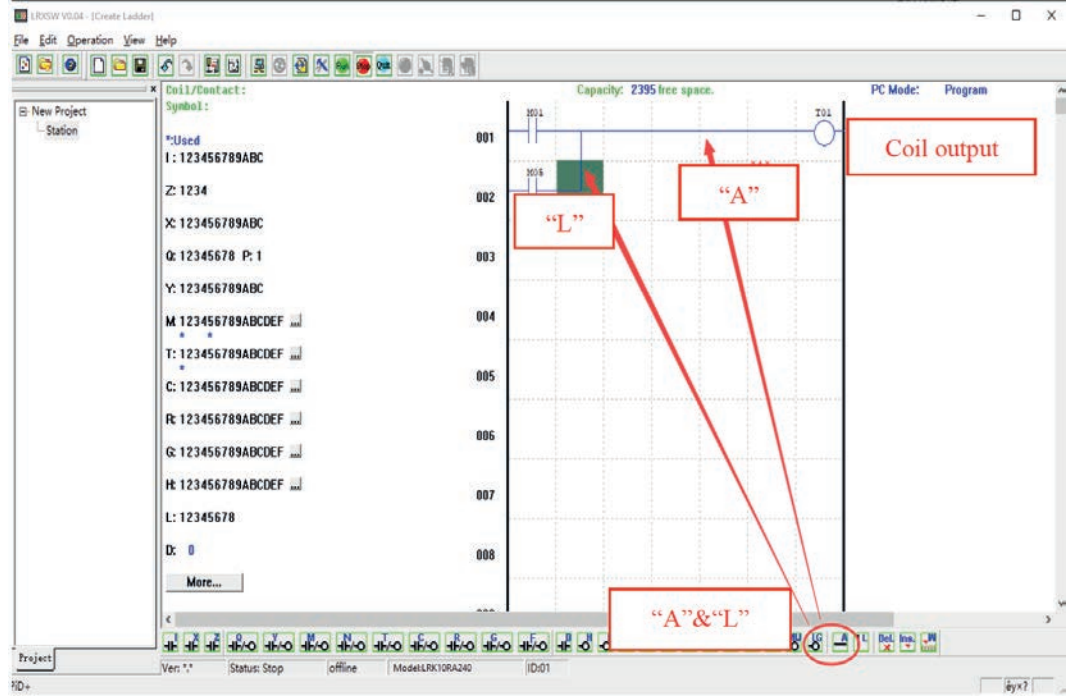

SIMULATION MODE

LRSW has built-in simulation test function to enable simulation test and debugging of program while it is not downloaded to LRK controller. While LRSW is not connected to the controller, click the icon RUN to enter the simulation mode, as shown below. Some display characteristics in the simulation mode are also shown below.

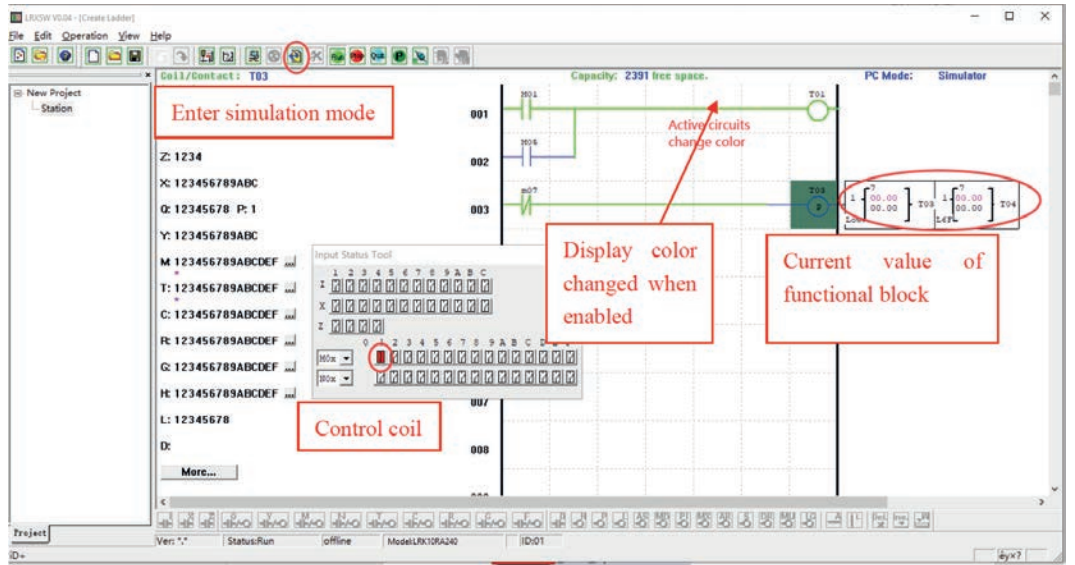

ESTABLISH THE CONNECTION

The procedures for establishing the connection between PC programming software LRXSW and LRK micro-plc are described below:

- a. Select "Operation → Link..." in the menu, when the serial port selection window pops up, as shown below;

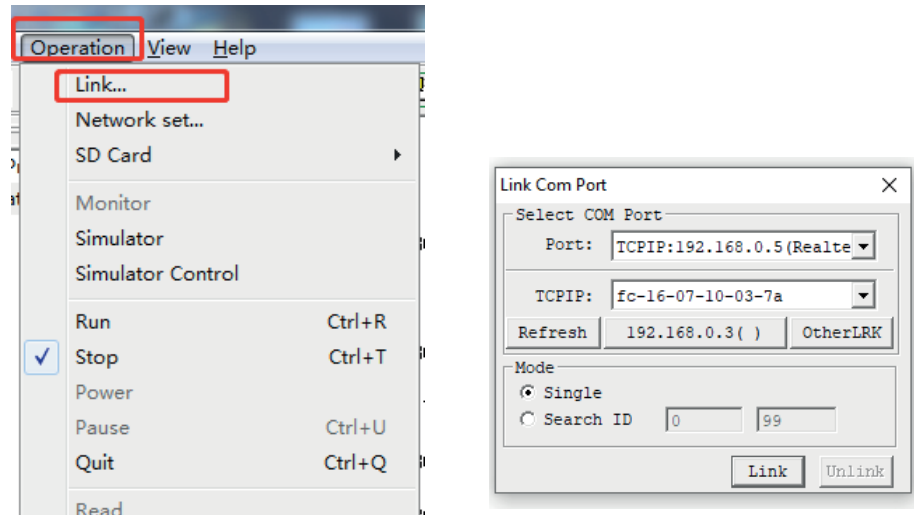

- b. Configure the correct IP address of PC and LRK device, select the correct TCPIP of the connection between LRK micro-plc and PC, and click "Connect";
 c. The PC Client programming software LRXSW is automatically connected with LRK micro-plc.

WRITE PROGRAM

As shown below, click the menu "Operation → Write" to write the edited program into the connected LRK micro-plc; or click the icon WRITE in the programming tool bar to write the program.

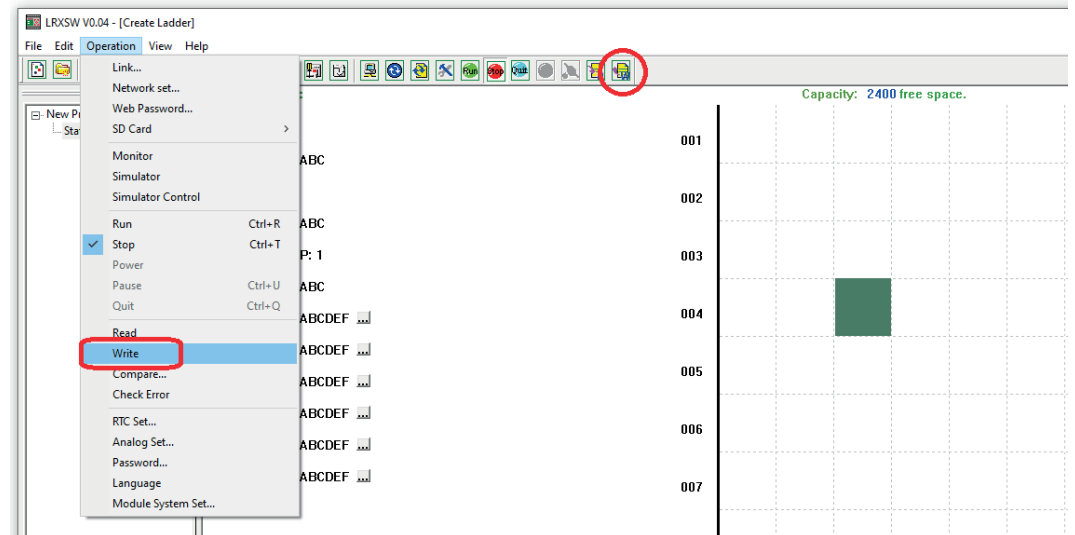

ONLINE MONITORING

LRXSW programming software allows online monitoring of the running program state, forced control of IO state and change of mode (Run, Stop or Exit).

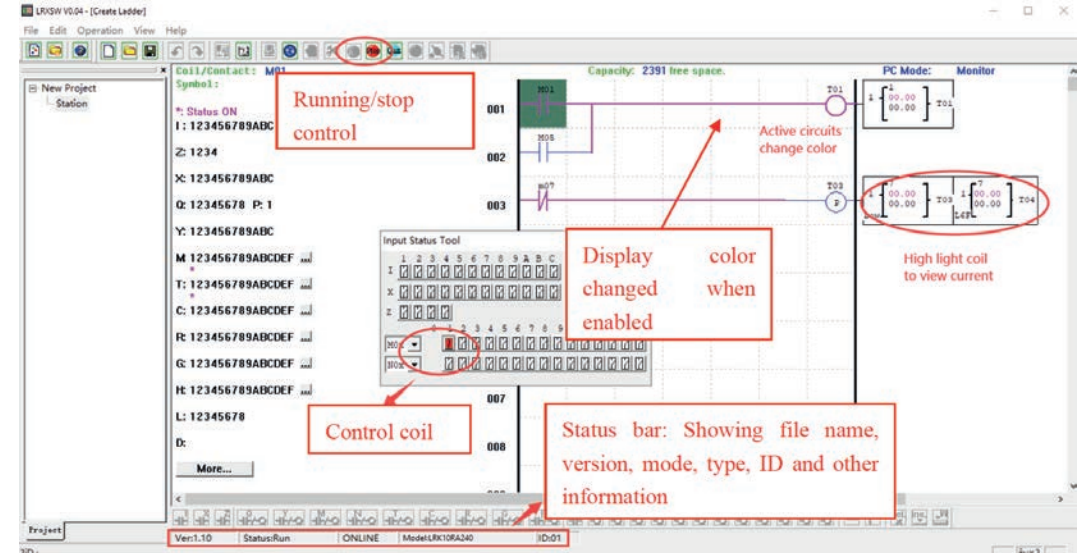

* LRK does not support online change of program control logic in the running mode. All logic editing (including coil, timer, counter and functional connection) must be written while LRK is in the stop mode.

RUN MENU

The Run menu includes some system setting functions to enable function setting while LRK is connected or not connected. The detailed reference is listed below:

Run menu	Function description
Link	Select the communication port of PC software and controller;
Network set	Set network communication related parameters, and network input/output map;
SD Card	Set storage card operation;
Monitor	Run online monitoring function and change coil state when LRK is connected;
Simulator	Test and debug program while LRK is not connected;
Simulator Control	Set user-defined control of simulation;
Run	Change to the running state and enter the monitoring mode while LRK is connected, or enter the simulation mode while it is not connected;
Stop	Change to the stop state while LRK is connected, or exit the simulation mode while LRK is not connected,
Power	Simulate the power down state in the simulation mode;
Pause	Suspend in the simulation mode;
Quit	Exit the monitoring/simulation mode;
Read	Read program from LRK micro-plc;
Write	Write program into LRK micro-plc;
Compare	Read program from LRK micro-plc; and compare with the current PC program;
Check Error	Check errors in user program;
RTC Set	Set real-time clock and summer time/winter time while LRK is connected;
Analog set	Set the gain and offset of analog input A01~A08;
Password	Set password to control access to the current program written into LRK;
Language	Set the menu display language of LRK controller;
Module system setting	Important setting function of LRK system, including module ID, function setting of RS485 type and extended settings

As shown in the figure below: Compare, RTC Set, Analog Set, Module System Set

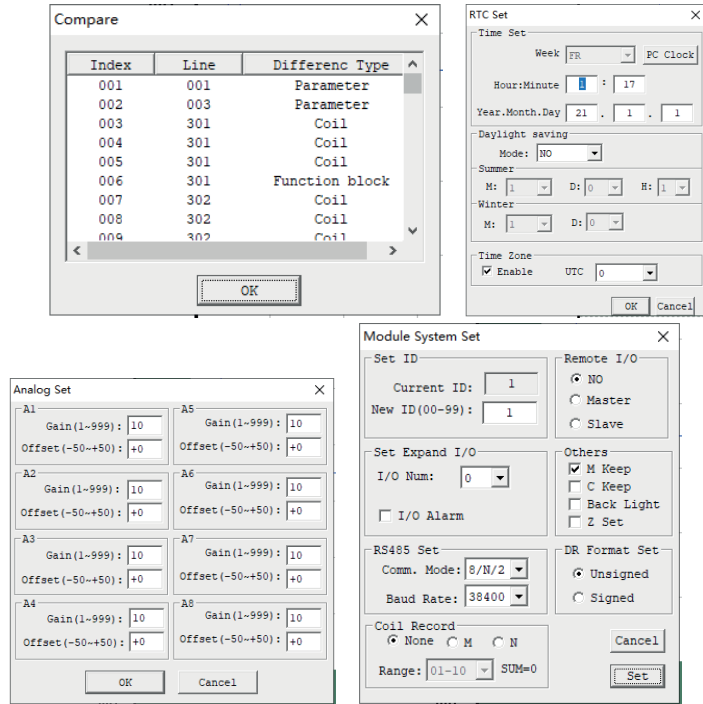

HMI/TEXT

HMI functional blocks: Status information displayed on 16*4 LCD of LRK includes:

1. Current and preset values of functional blocks, including timer, counter, RTC, comparator and DR register; the preset values of these functional blocks can be modified by the displayed HMI in the running mode;
2. Coil status, including input I, key input Z, extended input Z and auxiliary coil M; status of M may be modified by the displayed HMI in the running mode;
3. Analog input and output values, including analog input A, temperature input AT and analog output AO;
4. Built-in ASCII characters and characters of other languages; 85 built-in Chinese characters;
5. Not used.

Enter HMI/Text editing and parameter setting interface, as shown below:

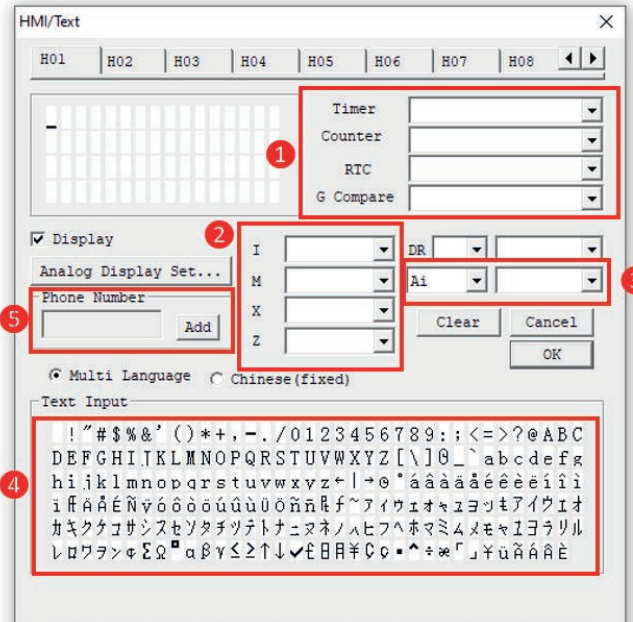

HMI/TEXT editing steps: The steps ①~⑦ are shown and described below:

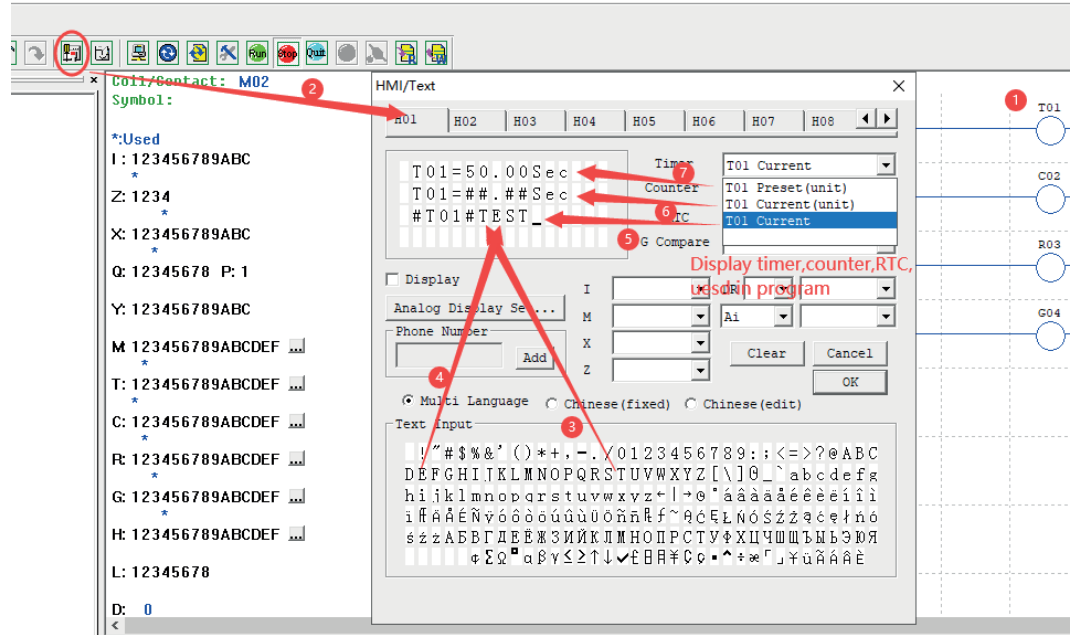

- ① Enter coil H01;
 - ② Enter the HMI/TEXT editing interface;
 - ③ Select letter "T"
 - ④ Select letter "E"
 - ⑤ Select the current value of timer T01
 - ⑥ Select the current value of timer T01 (with unit)
 - ⑦ Select the preset value of timer T01 (with unit), which can be modified when H01 is displayed on LCD;
- H01 setting mode 1: download program into LRK controller; press the key SEL to display H01 content on LCD when stopped (as shown in the left below); put I01 to ON to enable H01 and display H01 content on LCD during running (as shown in the right below).

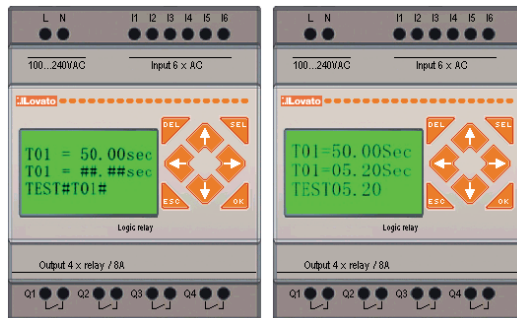

- I. Press "↑" or "↓" to select other H coil;
- II. Press "SEL" and then press "↑" or "↓" to change the preset value of T01, and then press "OK" for confirmation (in this example, T01=50.00sec may be modified, and the present value of T01 is edited and displayed on HMI).

BUILT-IN ASCII CHARACTERS AND OTHER LANGUAGES:

There are various built-in languages, including English, French, Spanish, Italian, German, Portuguese and Polish; In addition, it can be set to display in Russian or Turkish characters.

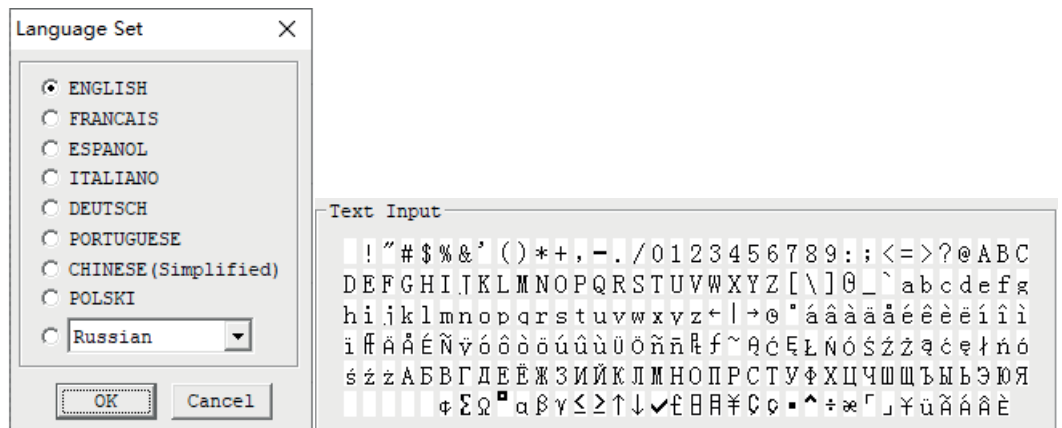

85 built-in Chinese characters: The content is shown in the HMI/TEXT editing window in the left below;

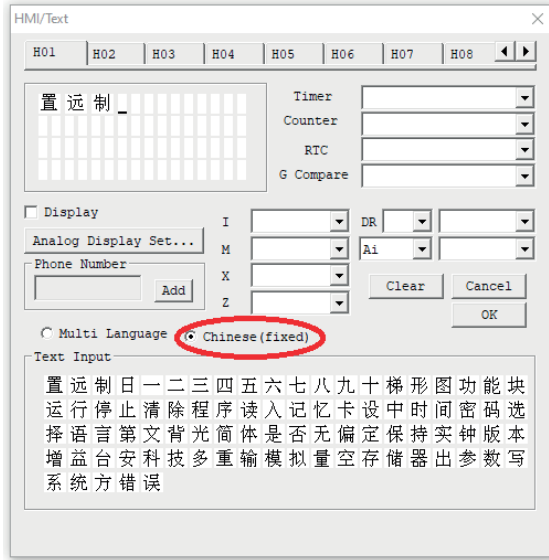

Example: HMI/TEXT function and input function of the key Z

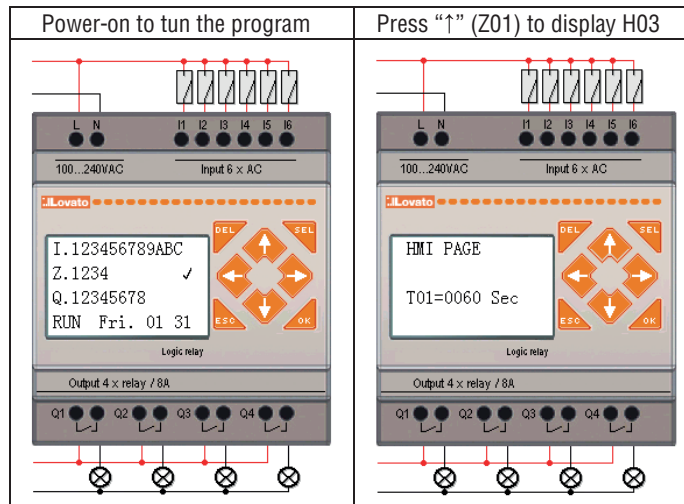
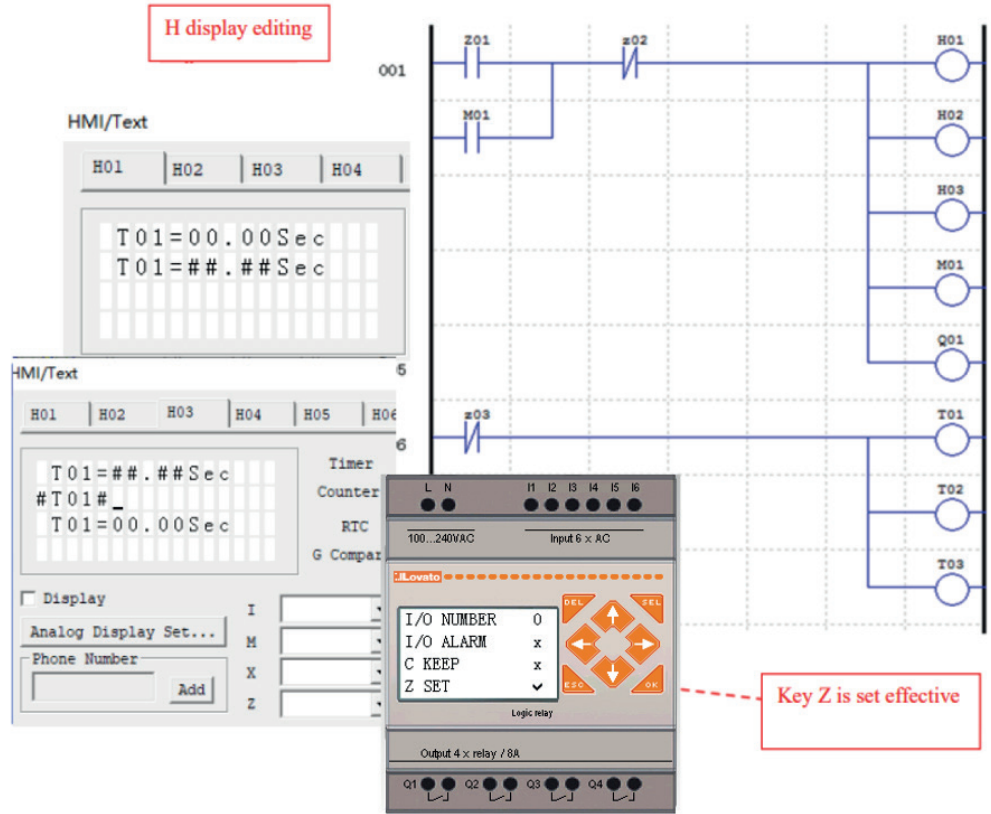

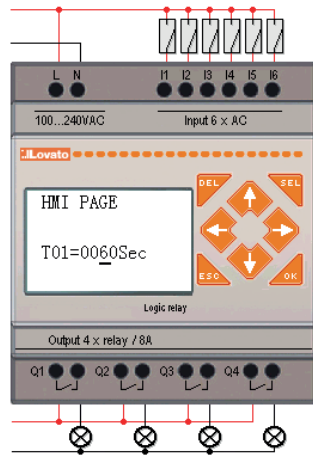

- ① Press "SEL", when the cursor blinks;
- ② Press "↑", "↓", "←" or "→" to move the cursor;
- ③ Then press "SEL", the blinking cursor changes to underline in the editable position;
- ④ Press "↑" or "↓" to change digital value, and press "←" or "→" to confirm the input and move the underline.
- ⑤ Press "OK" to complete editing.

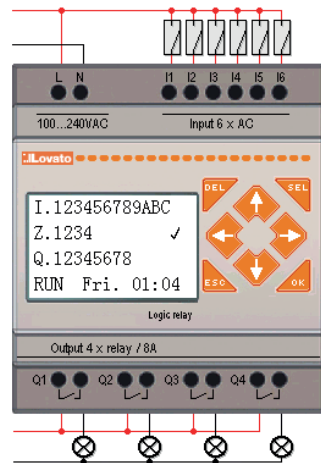

Press "←" (Z02) to disable H03, when the initial screen is displayed on LCD, as shown to the left.

Press "↓" (Z03) to disable timer T01, T02 and T03.

PROGRAM COMMENT

LRXSW programming software allows editing of comment, including contact coil symbol and full line of comment. Contact coil symbol uses a form, and each contact coil address allows input of 12 characters to the maximum.

A line of comment may be used for description of a program function, and each line comment allows input by four lines, with the maximum length of 50 characters in each line.

CONTACT/COIL SYMBOL

Select the menu "Edit (E) -> Symbol" or click the symbol "... " or "More..." in the resource list for editing of contact/coil symbol; enter symbol in the corresponding number after the coil is selected; the contact/coil symbol editing function enables editing of all coil types and setting of display in the program editing area, as shown below.

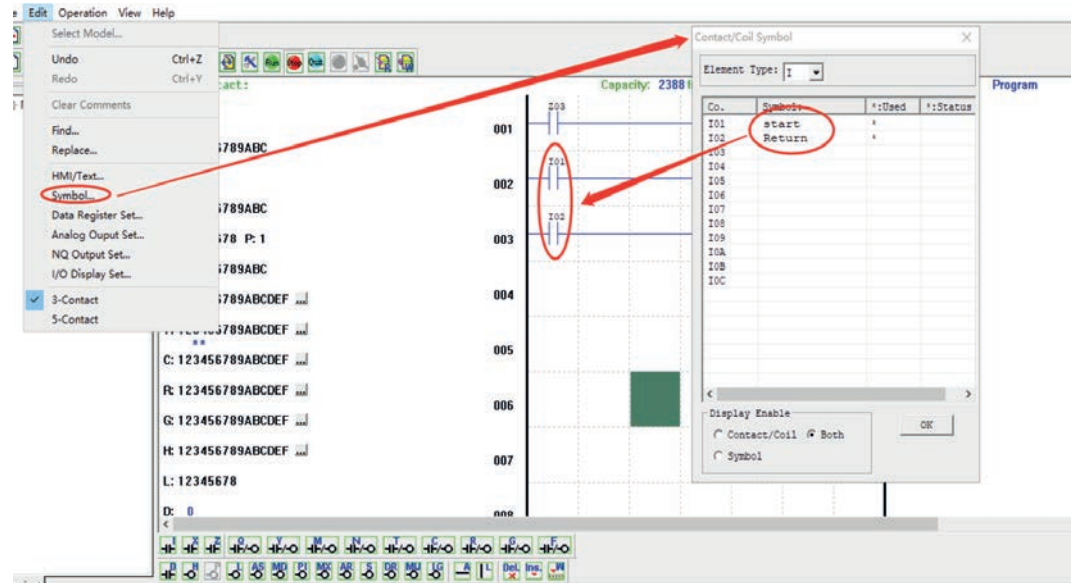

LINE COMMENT

Click the icon "W" in the Ladder tool bar to enter line comment editing.

After click of "W", move cursor to the line to be commented, and then click cursor to release it and edit the comment content, and finally press "OK" to complete editing, as shown below.

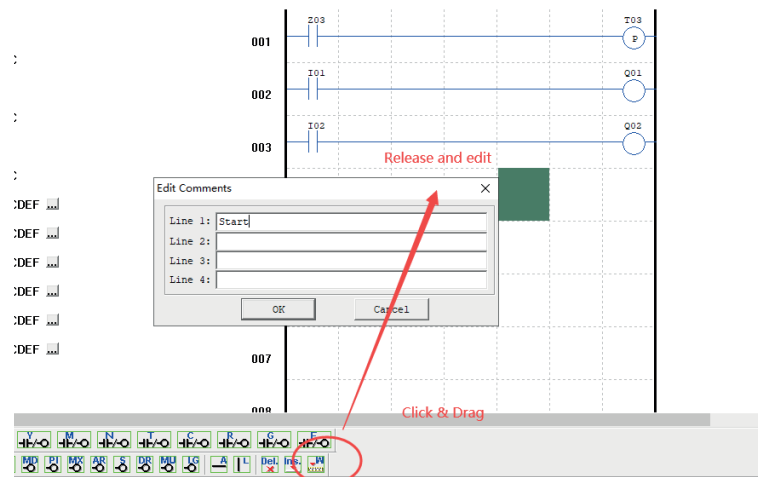

AQ ANALOG OUTPUT SETTING

Select the menu "Edit (E) -> Analog Output set" for editing of analog output, as shown in the left below. After the setting dialog box pops up, use channel 1~channel 4 for setting output AQ01~AQ04.

When AQ0x is in the voltage output mode, the preset value range is 0~4095; When AQ0x is in the current output mode, the preset value range is 0~2047.

The preset value may be a constant or the current value of other data types. See the following diagram for setting of output mode and preset value, and refer to Chapter IV: Ladder Programming Instructions—AQ analog output instruction for more information about display of output mode and other modes.

The preset value of AQ output mode is stored in the current value of register DRD0~DRD3, and preset value of AQ output in the current value of register DRD4~DRD7.

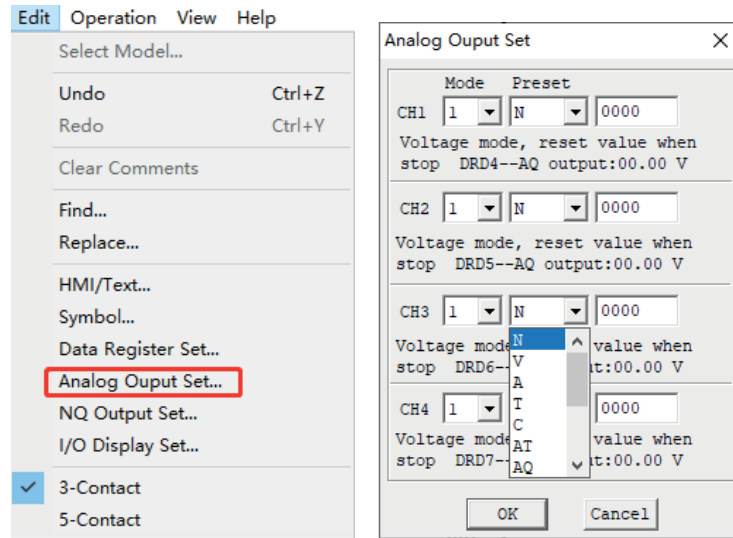

The above register and output are explained below:

	Mode register	Output register	AQ output
Channel 1	DRD0=0 AQ output mode 1: voltage mode, reset to 0 when stopped.	DRD4=3000	AQ01=732 (DRD4/4.095) AQ output 7.32V;
Channel 2	DRD1=1 AQ output mode 2: current mode, reset to 0 when stopped.	DRD5=A01*4.09 5 Current mode 0~2047	AQ02=A01 Current mode 0~500;
Channel 3	DRD2=2 AQ output mode 3: voltage mode, output maintained when stopped.	DRD6= V01 * 4.095 Voltage mode 0~4095;	AQ03=V01 Voltage mode 0~1000;
Channel 4	DRD3=3 AQ output mode 4: current mode, output maintained when stopped.	DRD7=2047	AQ04=500 (DRD7/4.095) AQ output 20.00mA.

* When the type of preset value of AQ is a constant, value of the corresponding DR register changes, and AQ output value is modified accordingly ($AQx=DRx/4.095$);

* When the type of preset value of AQ is other parameter variable, value of DR register varies with AQ ($DRx=AQx*4.095$);

3-COLUMN INPUT/5-COLUMN INPUT

The editing mode of 3-column input or 5-column input may be selected in the LRK LADDER programming mode. In the 3-column mode, three input coils and one output coil or functional block may be used in a line of Ladder instruction. The maximum number of lines of program is 500.

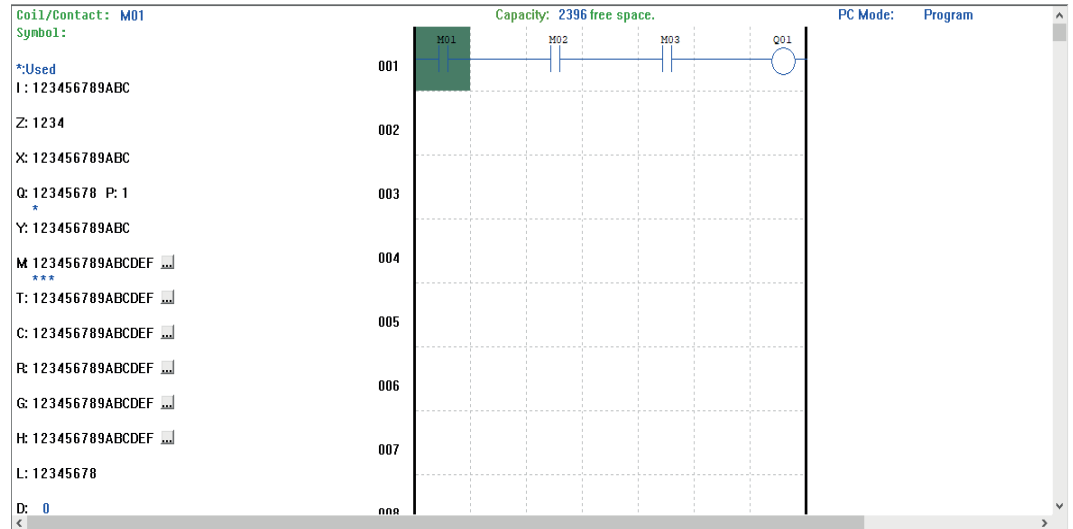

In the 5-column mode, five input coils and one output coil or functional block may be used in a line of Ladder instruction. The maximum number of lines is 300.

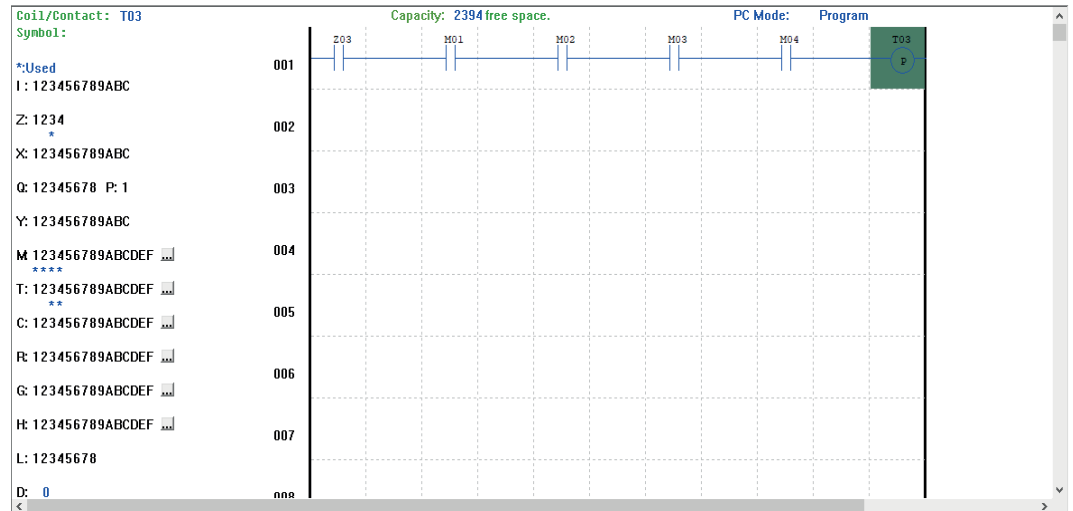

In the 3-line mode, it is impossible to change to the 5-line mode when the number of lines edited exceeds 200.
In the 5-line mode, it is impossible to change to the 3-line mode when the number of inputs in a line exceeds 3.

DR DATA REGISTER SETTING

Data type of DR may be the type with symbol or without symbol, which may be set as shown below. For data without symbol, DR range is 0~65535; for data with symbol, DR range is -32768~32767

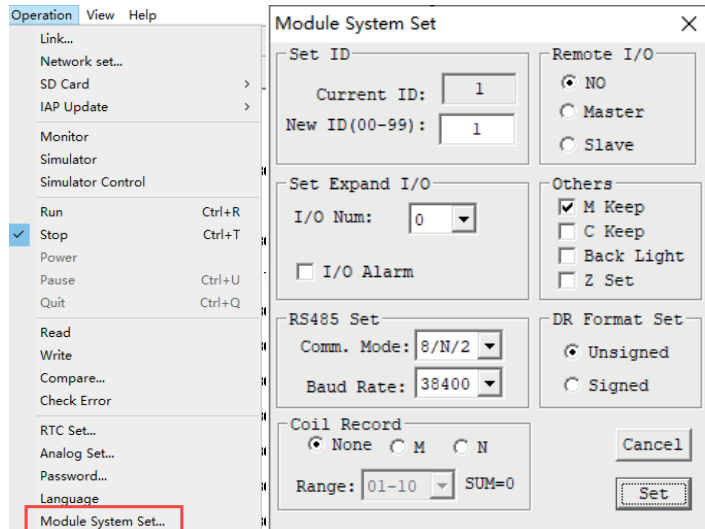

After the above operation, select the menu "Edit (E) Data Register Set" to enter the setting dialog, as shown below; the preset value of DR may be a constant or the current value of other functional block.

DR should be used according to DR instruction, and some DR has special function definition; refer to Chapter IV: Ladder Programming Instructions—DR data register instruction for more information.

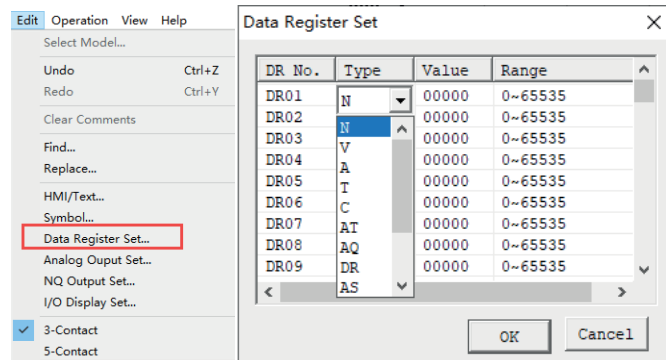

When DR is data with symbol, "DR data register setting" is shown as below:

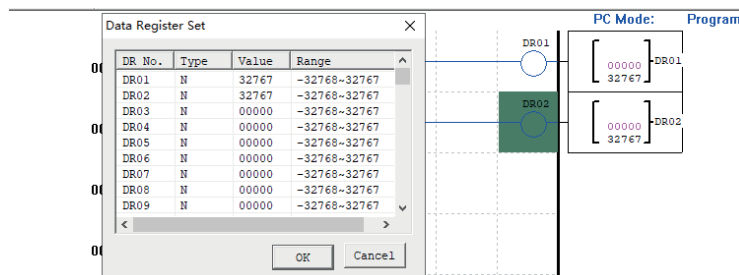

DESCRIPTION OF SPECIAL DR FUNCTION

The current value of DR65~DRF0 may be kept in case of power failure.

When DR is used as a special register, the enabling coil is not to be set. For enabling coil setting of special register under the enabled state ON, the current value of DR register will be covered by the preset value of the register. Therefore, it should be checked whether the current value of DR register is the value required by user when DR special register is used as a general data register in the program.

Specifically, DRD0~DRE3 are special registers for parameter setting. Its function of current value output is described below:

No.	Function description	
DRD0	AQ01 mode	0, voltage mode, output 0 when stopped; 1, current mode, output 0 when stopped; 2, voltage mode, original value kept when stopped; 3, current mode, original value kept when stopped;
DRD1	AQ02 mode	
DRD2	AQ03 mode	
DRD3	AQ04 mode	
DRD4	AQ01 output value 0~4095	Analog output setting;
DRD5	AQ02 output value 0~4095	
DRD6	AQ03 output value 0~4095	
DRD7	AQ04 output value 0~4095	
DRD8	I/O interface hiding	Refer to "Chapter III: LCD Display and Keys> initial screen" for details.
DRE1~DRE3	Standby registers for parameter setting	

DRC9~DRCF and DRD9~DRF0 are special status registers, the current value output function of which is described below:

No.	Function description	
DRC9	PLSY instruction for output of current value of pulse number	
DRCA	AT01 current Fahrenheit degree	Used as general DR register when there is no AT01~AT04 (4PT not connected)
DRCB	AT02 current Fahrenheit degree	
DRCC	AT03 current Fahrenheit degree	
DRCD	AT04 current Fahrenheit degree	
DRCF~DRCF	Sunrise/sunset time of RTC functional block	
DRD9~DRDF	Save current value of RTC	Year, month, day, week, hour, minute, second
DRE0	Finally enabled M/N number	M/N range is selected as status memory in the system setting, and the most recently enabled M/M number is recorded in DRE0 during program running.
DRE1~DRE3	Standby special status register	
DRE4	A05 current value 0~2000	Used as general DR register when there is no AT05~AT08 (4AI not connected)
DRE5	A06 current value 0~2000	
DRE6	A07 current value 0~2000	
DRE7	A08 current value 0~2000	
DRE8	A01 current value 0~4095	Used as general DR register when there is no A01 and A02 (AC type);
DRE9	A02 current value 0~4095	
DREA	A03 current value 0~4095	Used as general DR register when there is no A03 and A04 (AC type or 12-point DC);
DREB	A04 current value 0~4095	
DREC	A05 current value 0~4095	Used as general DR register when there is no A05~A08 (4AI not connected);
DRED	A06 current value 0~4095	
DREE	A07 current value 0~4095	
DREF	A08 current value 0~4095	
DRF0	Standby special status register	

VIEW MENU

The view menu includes some functions of display setting on PCLink software interface, as detailed below:

View menu	View function description
I/O	Display of the list of resources used;
Function	Display of functional block parameter;
Capacity	Display of free space of program;
Input Status Tool...	Monitoring and simulation of status of coils I, X, Z, M and N;
I/O Link Status Tool...	Monitoring and simulation of internal W status of IO Link (for RS485 only);
Analog tool...	Monitoring and simulation of master analog input A01~A04 (for DC only);
Extended Analog tool...	Monitoring and simulation of extended analog input A05~A08;
High-Speed input Tool...	Simulation of the function of high-speed input I01 and I02 (for DC only);
AT Tool...	Monitoring and simulation of extended temperature input AT01~AT04;
Ladder Toolbar	Display of Ladder tool bar;

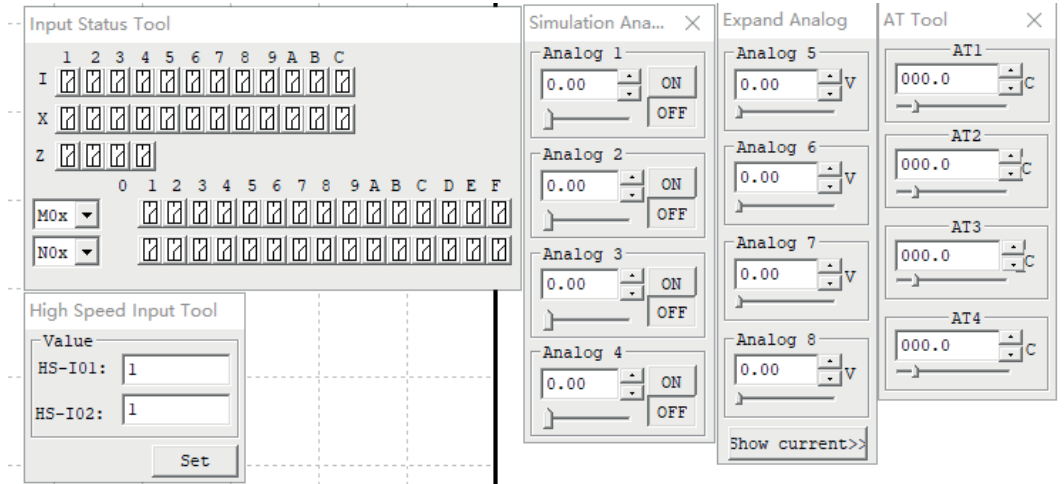

- Analog input A01~A04 corresponds to input I09~I0C;
When analog input is up to 9.98V, the corresponding coil status is put ON; when it is down to 5.00V, the coil is put OFF;
- Extended analog input A05~A08: Input range is 0~9.99V; specifically, 0~5.00V corresponds to 0~20.00mA current mode display;
- Extended temperature input AT01~AT04: Input range is -100.0~600.0;
- High-speed input tool for simulating high-speed input of DC type.

FBD PROGRAMMING ENVIRONMENT

The functional block diagram (FBD) programming environment includes all programming and simulation functions; select the menu "File (F) > New (N)" and choose the type LRK (as shown below) to begin new programming.

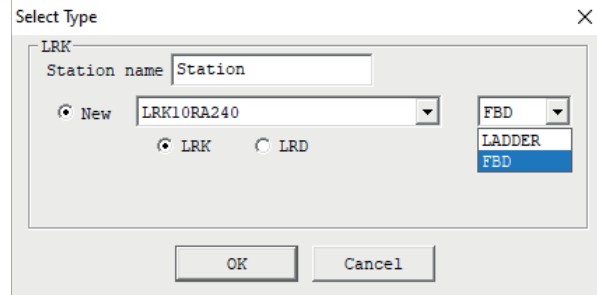

The programming operations under FBD are similar to Ladder, as described below.

MENU, ICON AND STATUS BAR

FBD programming includes the following menu, icon and status bar.

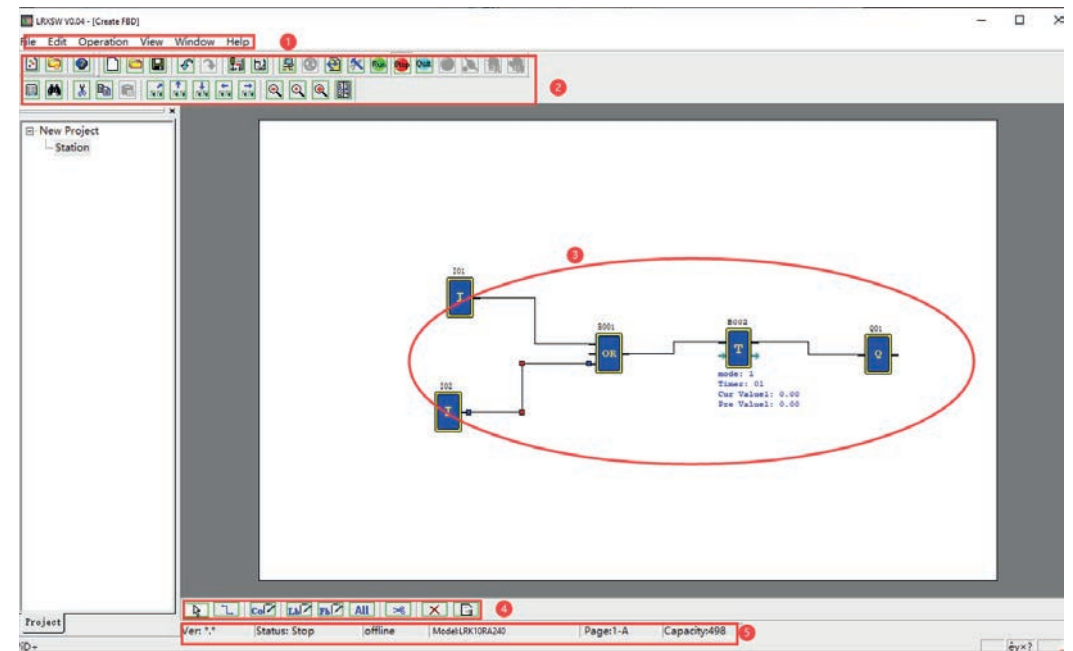

1. Menu: 6 menu options, including file operation, editing, LRK communication setting, special functions, display setting and help information;
2. Tool bar: The icons in the first row are (from left to right): New, Open, Save program icon; Monitor, Simulation, Control mode change (RUN, STOP and QUIT), Read program from LRK and Write program into LRK; the icons in the second row are (from left to right): Key panel display, FBD display, HMI/TEXT editing, comment symbol editing and parameter list etc.
3. Programming area: Move the coil and logic function block to be programmed into the editing area, and use line connection;
4. FBD tool bar: Select coil and functional block instruction for editing;

--	--	--	--	--	--	--	--

 The icons (from left to right) represent: general selection, wiring, coil, logic function block (LFB), special function block, scissors operation, deletion and comment tool.
5. Status bar: It represents the current program, the connected LRK status and other information.

PROGRAMMING

LRXSW allows programming with mouse. The programming instructions are illustrated below.

Right click to pop up the left screen below, select Coil (C), or click FBD tool bar below the editing window (as shown in the right below), when all available coil icons appear in FBD tool bar.

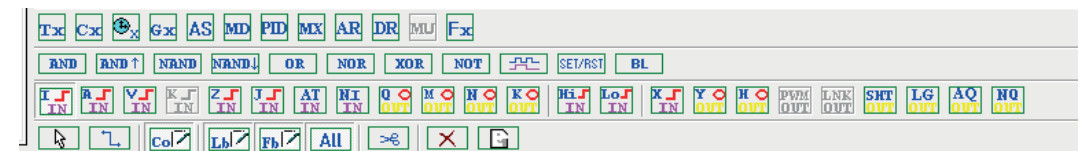

Select the symbols "M" and "Q", move icon to the editing area, and draw lines to connect the two coils, as shown in the left below (operation 1-3); if the lines are crossed, use the "Scissors" function for separate display of the lines, as shown in the right below (operation 4);

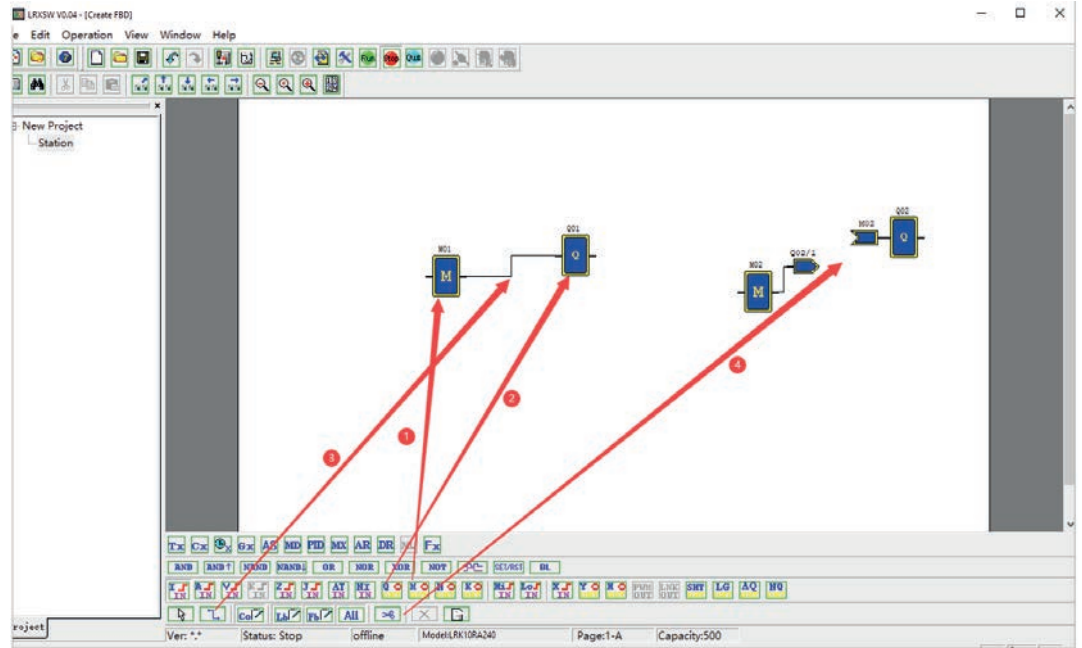

SIMULATION MODE

LRSXW has built-in simulation test function; the method for entering the simulation mode under FBD is consistent with Ladder. Some display features in the simulation mode are shown below.

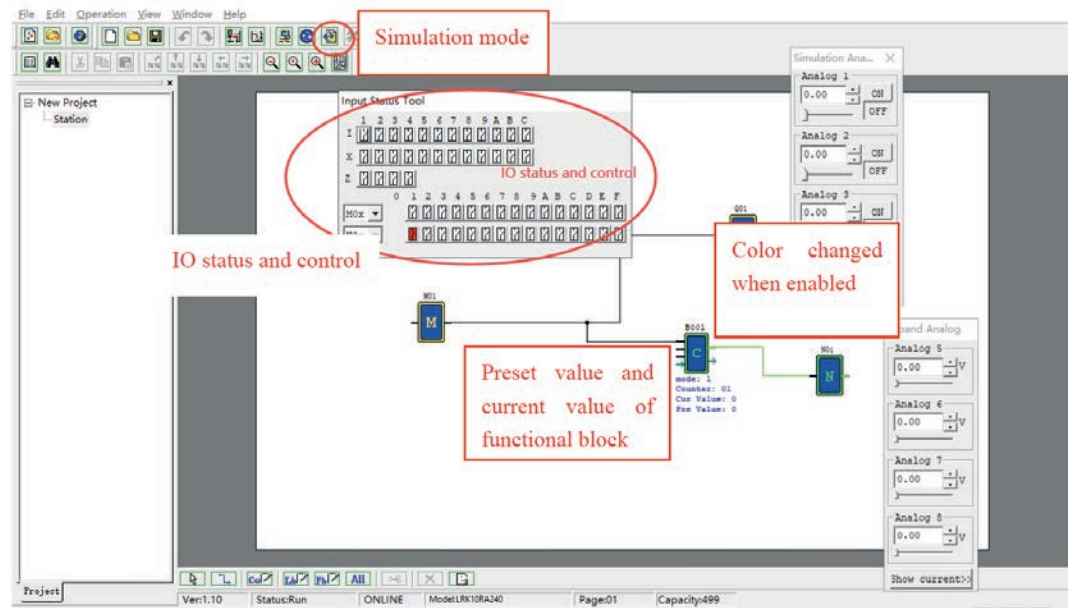

ONLINE MONITORING

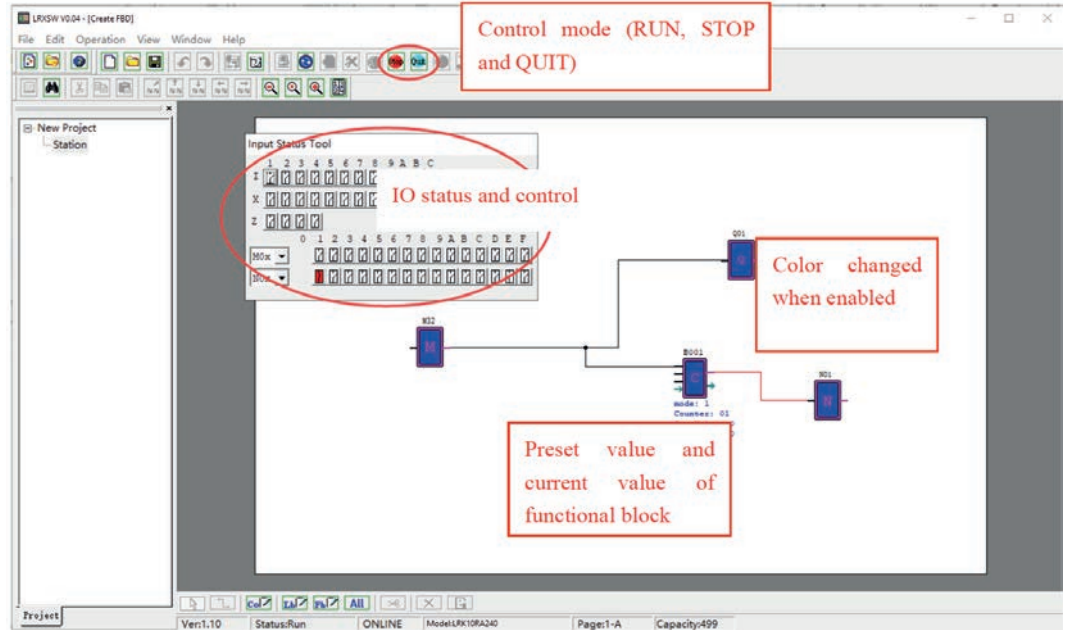

PROGRAM COMMENT AND PARAMETER LIST

Under FBD, comment is effective for the used coils and functional blocks only, and displayed in the program.

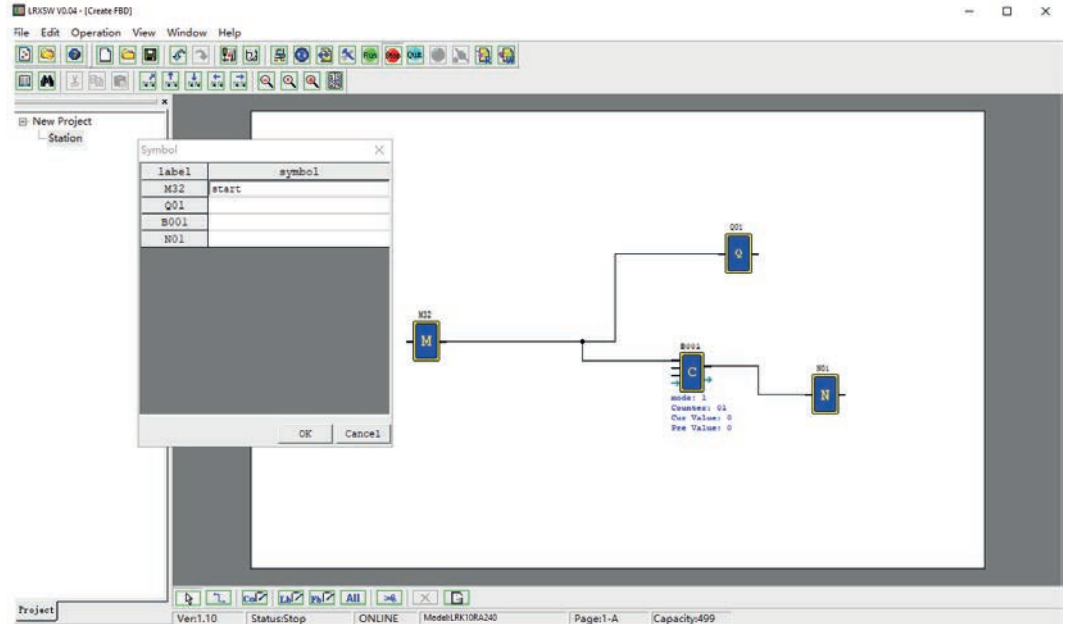

Comment is function description of the whole program. As shown below, click "Comment" in FBD tool bar to pop up the comment setting dialog box, and click "OK" after completion of editing, when comment is displayed on the programming interface and may be moved by cursor.

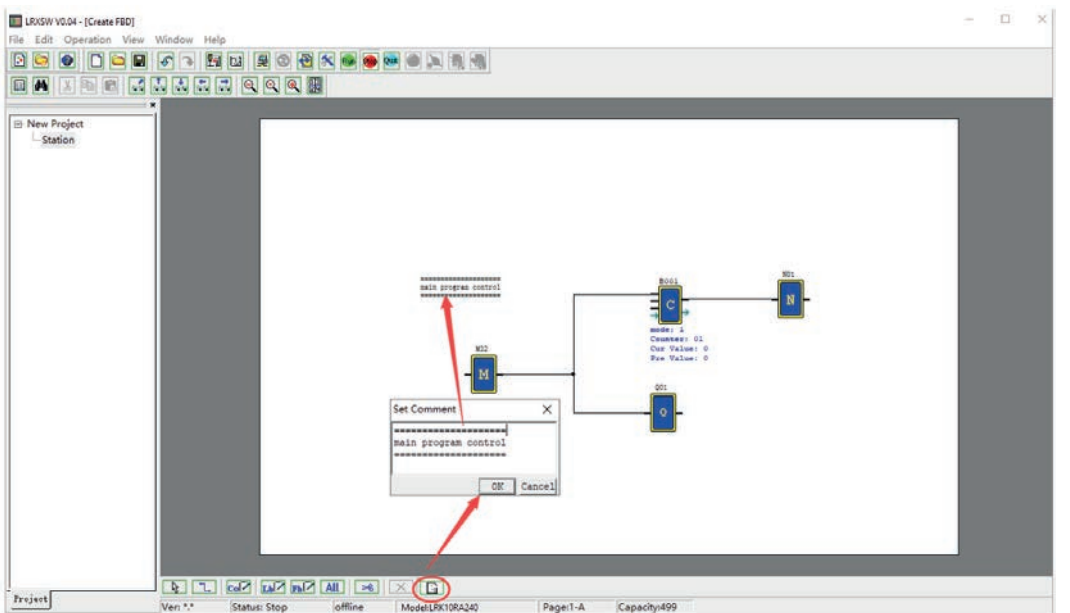

Parameter list:

Under FBD, all used coils and functional blocks are provided in the parameter list, which includes function and mark of coils, and set value and mark of functional blocks, as shown below.

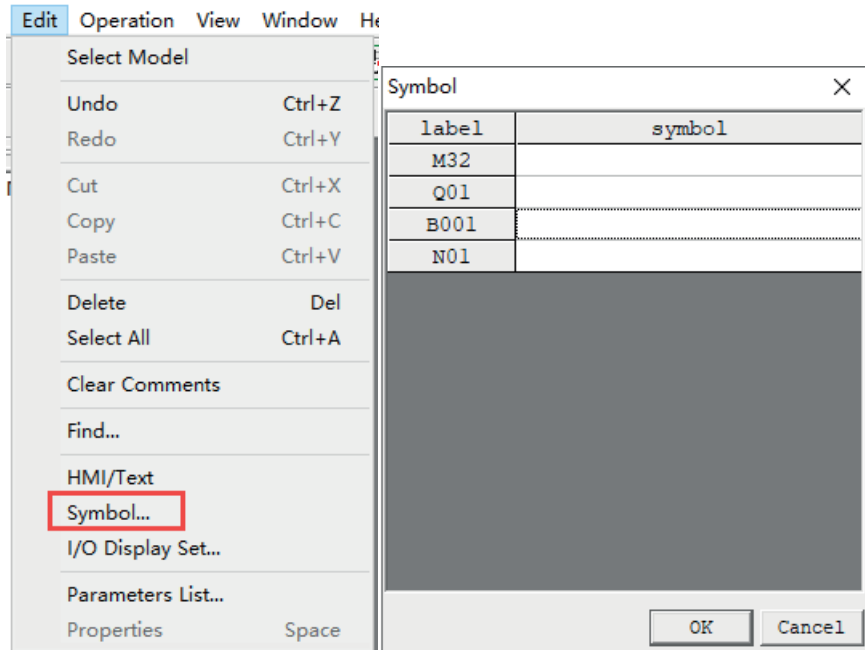

LCD DISPLAY AND KEYS

KEYS

The micro PLC LRK (excluded type LRK...B) integrate keypad and LCD display, which may be used for change of functional block setting, control of Run/Stop mode, user program reading and writing, real-time clock setting, as well as logic program editing in Ladder programming environment.

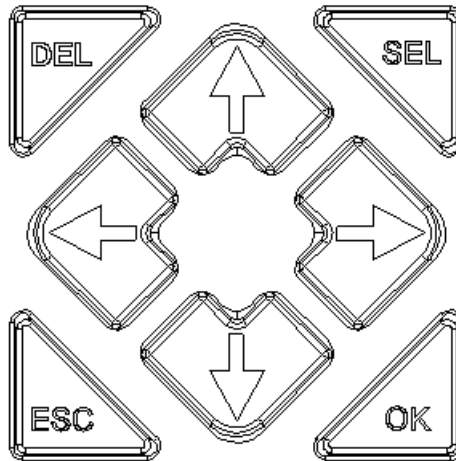

Definition of keys:

SEL – Editing and selection key: It is used to select coil function and editing instruction during program editing; the key “SEL” can be pressed on the initialization interface to display content of functional block H in the editing mode 1.

OK – Confirmation key: It is used for confirmation during instruction or functional block editing, or selection of display function on the menu interface.

* During Ladder programming, “SEL+OK” can be pressed to insert a line under the current cursor.

ESC – Cancellation key: It is used to return from the current display to the previous display interface, cancel the current editing or switch between the initial interface and menu interface. After modification of parameter, the key ESC can be pressed to save data.

DEL – Deletion key: It is used to delete instruction during Ladder programming.

Four direction keys (↑←↓→): They are used to move the cursor during LRK program display and editing. The four direction keys can also be used for input, which correspond to the input coils Z01~Z04 respectively (‘↑’= Z01, ‘←’=Z02, ‘↓’=Z03, ‘→’ =Z04).

INITIAL SCREEN
 LCD displays 4 lines of status information.
 © Power-on initial screen

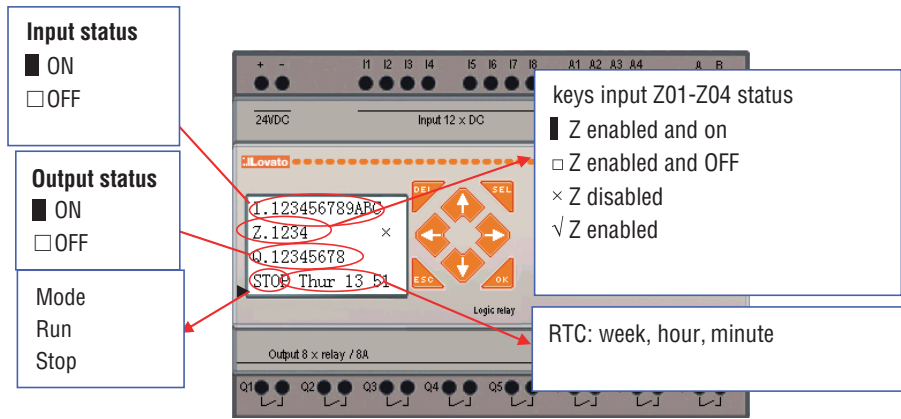

At this time, the following keys can be used.

ESC	Return to main menu
SEL+ ↑ ↓ or ↑ ↓	When the current value of DRD8 is 0 in the Ladder editing mode, the keys can be pressed to display status of other relay coils (I/Z/Q ⇔ X/Y ⇔ M ⇔ N ⇔ T ⇔ C ⇔ R ⇔ G ⇔ A ⇔ AT ⇔ AQ) When the current value of DRD8 is 0 in the FBD editing mode, the keys can be pressed to display status of other relay coils (I/Z/Q ⇔ X/Y ⇔ M ⇔ N ⇔ A ⇔ AT ⇔ AQ)
SEL+ ← → or ← →	Voltage/current display mode when A05~A08 is displayed; Fahrenheit/Celsius display mode when AT01~AT04 is displayed;
SEL	Functional block H with the minimum coded value in the display mode 1
SEL+OK	Enter RTC setting menu

© Extended status display interface

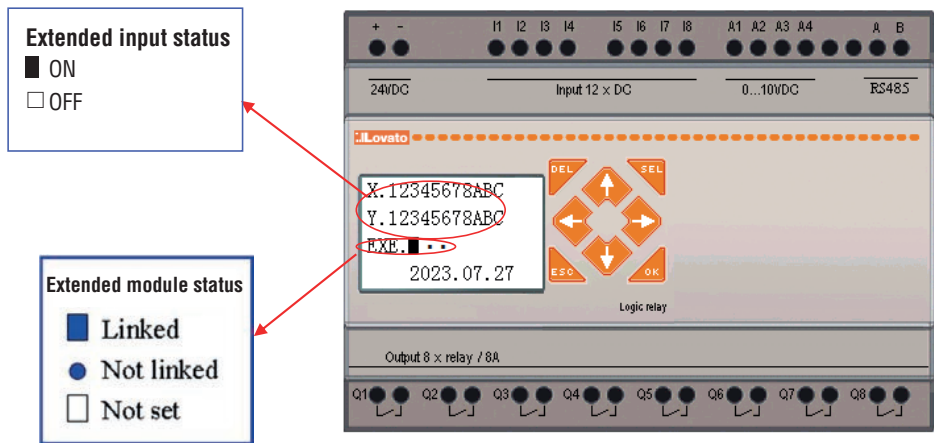

*Refer to the main menu "System setting" for extended module setting.

© Other status display

Status of coils M, N, T, C, R, G: (T, C, R and G are effective in the Ladder mode only)

Coil M2x~3x,
Being M, N,
T, C, R or G

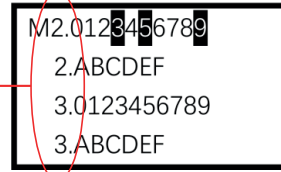

Analog input A01~A04: 0~9.99V

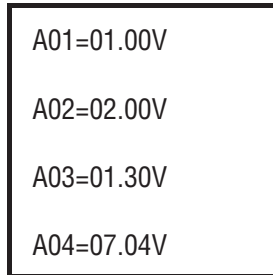

Analog input A01~A04: 0~9.99V

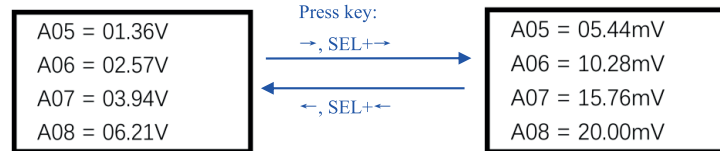

Extended analog temperature input AT01~AT04: -100.0°C~600.0°C or -148.0°F~1112.0°F

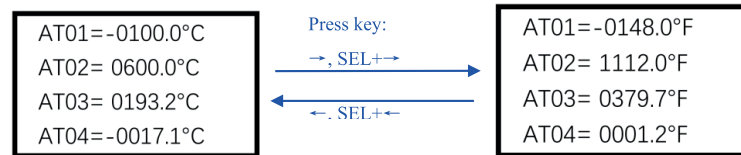

Extended analog output AQ01~AQ04: 0~10.00V or 0~20.00mA

*Voltage mode and current mode are set during programming, as described in Chapter IV: Ladder Programming Instructions—AQ analog output instruction.

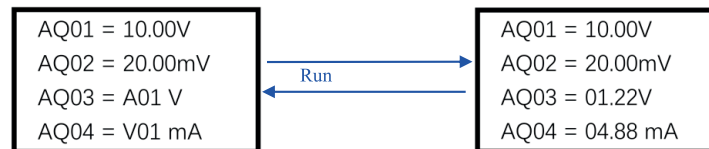

© I/O interface hiding: (to be tested)

The initial interface includes 14 I/O display interfaces in total. Each of the lower 14 bits of the current value of DRD8 corresponds to one I/O interface. When one of the bits is 1, the corresponding I/O interface is hidden (it is impossible to switch to this I/O interface by the keys SEL+↑ ↓ or ↑ ↓). The correspondence between the current value of DRD8 and I/O interface display is listed below:

No.	Display content of IO interface		Current value of DRD8
0	I/Z/Q	I01~I0C, Z01~Z04, Q01~Q08	Bit0: * displayed constantly and can not be hidden
1	X/Y	X01~X0C, Y01~Y0C	Bit1: displayed when =0; not displayed when =1
2	M1	M01~M1F	Bit2: displayed when =0; not displayed when =1
3	M2	M20~M3F	Bit3: displayed when =0; not displayed when =1
4	M3	M40~M5F	Bit4: displayed when =0; not displayed when =1
5	M4	M60~M7F	Bit5: displayed when =0; not displayed when =1
6	N1	N01~N1F	Bit6: displayed when =0; not displayed when =1
7	N2	N20~N3F	Bit7: displayed when =0; not displayed when =1
8	N3	N40~N5F	Bit8: displayed when =0; not displayed when =1
9	N4	N60~N7F	Bit9: displayed when =0; not displayed when =1
10	T	T01~T1F	Bit10: displayed when =0; not displayed when =1
11	C	C01~C1F	Bit11: displayed when =0; not displayed when =1
12	R	R01~R1F	Bit12: displayed when =0; not displayed when =1
13	G	G01~G1F	Bit13: displayed when =0; not displayed when =1

Example of interface hiding function: For I/O interface hiding, the Ladder/FBD program can be run directly to control the current value of DRD8, or PC-LINK be used directly to set the current value of DRD8. The procedure is described below:

1. Open "Edit>I/O display set...":

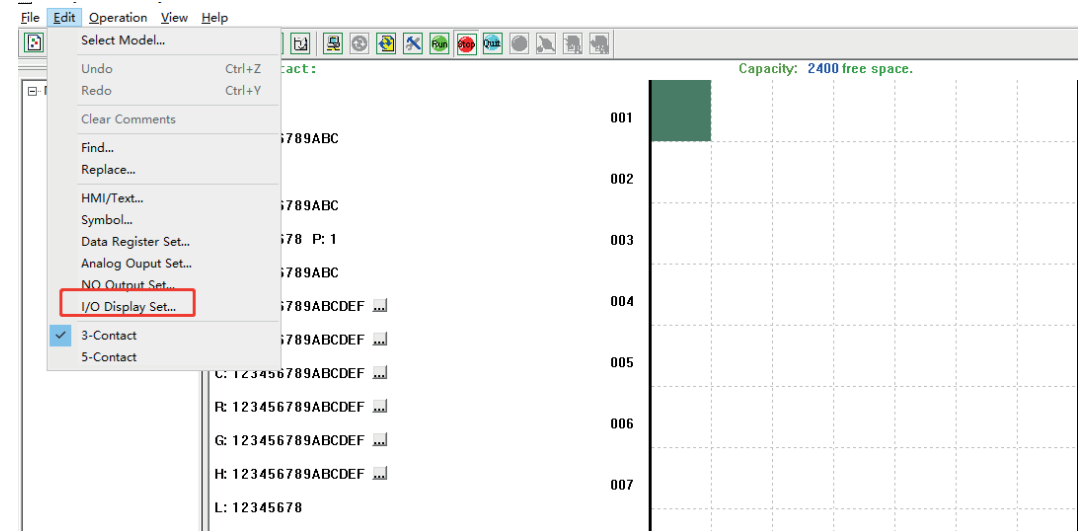

2. Set "I/O display setting" as shown below: (the checked I/O interface will be displayed)



3. Finally, use communication cable to connect PC and LRK, and download program into LRK.
After download, I/O interface "M01~M1F, M40~M5F, N01~N1F, N20~N3F, T01~T1F" will be hidden:

SEL+ ↑ ↓ or ↑ ↓	In Ladder mode, the current value of DRD8 is 1750, and relay coils are displayed as below (I/Z/Q ⇔ M ⇔ N ⇔ T ⇔ C ⇔ R ⇔ G ⇔ A1 ⇔ A5 ⇔ AT ⇔ AQ) ⇔ initial screen
--------------------	---

*In FBD mode, the same method can be used to hide I/O interface.

MAIN MENU SCREEN

(1) Main menu screen when LRK is stopped.

On LRK initial interface, press "ESC" to enter Ladder main menu or FBD main menu:

		Menu	Description
LADDER	FBD	> LADDER	Ladder edit
FUN.BLOCK	PARAMETER	FUN.BLOCK	Ladder function block (timer/counter/RTC ...) edit
PARAMETER	RUN	FBD	FBD display
RUN	DATA REGISTER	PARAMETER	FBD block or LADDER function block parameter display
DATA REGISTER	CLEAR PROG.RAM	RUN	RUN or STOP
CLEAR PROG.RAM	PLC->CARD	DATA REGISTER	DR display
PLC->CARD	CARD-> PLC	CLEAR PROG.	Clear the user program and the password
CARD-> PLC	SET	PLC->CARD	Save user program to SD card
SET	RTC SET	CARD-> PLC	Read user Program from SD card
RTC SET	ANALOG SET	SET	System setting
ANALOG SET	PASSWORD	RTC SET	RTC setting
PASSWORD	LANGUAGE	ANALOG SET	Analog setting
LANGUAGE	INITIAL	PASSWORD	Password setting
INITIAL	OUTPUT RECORD	LANGUAGE	Select the language
OUTPUT RECORD	NET IO STATUS	INITIAL	initially set Edit method
FORMAT Card		OUTPUT RECORD	output Save r files to the card
NETCONFIG		FORMAT Card	Format SD card
NET IO SET		NETCONFIG	Setting IP address, gateway and IAP upgrade
		NET IO SET	I/O setting of network communication
		NET IO STATUS	I/O status of network communication

(2) Main menu display of LRK running screen

		>	LADDER	FBD
LADDER	LADDER		LADDER	FBD
FUN.BLOCK	PARAMETER		FUN.BLOCK	
PARAMETER	RUN		PARAMETER	FBD block or LADDER function block parameter display
RUN	DATA REGISTER		STOP	RUN or STOP
DATA REGISTER	PLC->CARD		DATA REGISTER	DR display
PLC->CARD	RTC SET		WRITE	Save user program to card
RTC SET	PASSWORD		RTC SET	RTC setting
PASSWORD	LANGUAGE		PASSWORD	Password setting
LANGUAGE	OUTPUT RECORD		LANGUAGE	Select the language
OUTPUT RECORD	NET IO STATUS		OUTPUT RECORD	output Save r files to the card
NET IO STATUS			NET IO STATUS	Monitor J K NAI NAQ

At this time, the following keys can be used.

↑ ↓	Move cursor and select main menu function
OK	Enter the selected main menu function
ESC	Return to initial screen

* It is possible for program modification, editing, clearing and reading only when LRK is stopped.

* When user program is modified, LRK will automatically back up program in internal FLASH.

◎ Ladder diagram

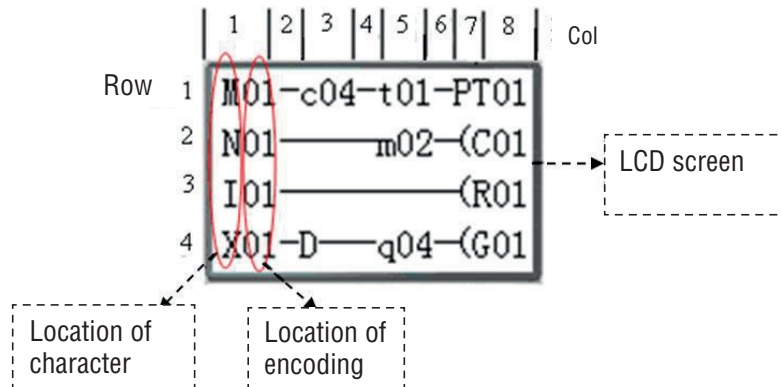

At this time, the following keys can be used.

Key	Function description
SEL	1. lxx → ix → → space → lxx (Used for digit or character in columns 1, 3 and 5 only) 2. Qxx → space → Qxx (Used for digit or character in column 8 only) 3. → Space → (Used for columns 2, 4 and 6, except the first row)
SEL+ ↑/↓	1. I ↔ X ↔ Z ↔ Q ↔ Y ↔ M ↔ N ↔ J ↔ K ↔ D ↔ T ↔ C ↔ R ↔ G ↔ F ↔ I (when cursor is in columns 1, 3 and 5) 2. Q ↔ Y ↔ M ↔ N ↔ T ↔ C ↔ R ↔ G ↔ H ↔ L ↔ P ↔ S ↔ F ↔ AS ↔ MD ↔ PI ↔ MX ↔ AR ↔ DR ↔ MU ↔ Q (when cursor is in column 8) 3. (↔ A ↔ V ↔ P ↔ ((when cursor is in column 7 and coil in column 8 is Q, Y, M or N) 4. (↔ P ↔ ((when cursor is in column 7 and coil in row 8 is T)
SEL + ←/→	Confirm the input data and move the cursor
↑↓←→	Move the cursor
DEL	Clear an instruction component
ESC	1. Enter data, save automatically, and move cursor to the next input program 2. Press the key in column 8 to automatically enter functional block for setting of parameters (such as T/C...)
SEL+DEL	Delete a line of instruction
SEL+ESC	Display number of lines and status of LRK (RUN/STOP)
SEL+ ↑/↓	4 lines of program skipped after each press, namely page turning
SEL+OK	Inset a blank line above the current cursor

© Functional block

Enter functional block, when the cursor blinks over T; press SEL to enter the editing mode, and press SEL continuously, when Ladder block displays the following: T → C → R → G → H → L → P → S → F → AS → MD → PI → MX → AR → MU → T...

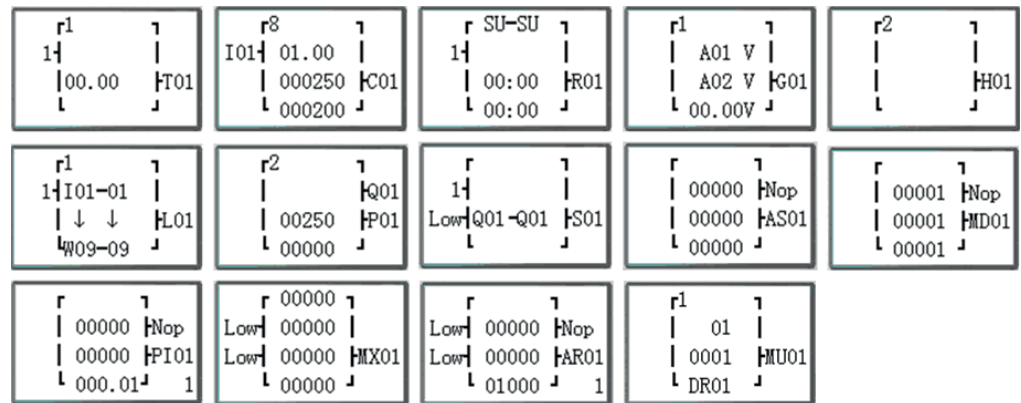

Functional blocks PI and AR are available for the following key operation:

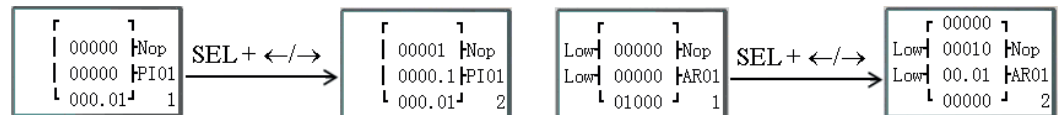

Refer to Annex B: Key editing of functional block parameters in Ladder mode for more instructions on key operation.

© Parameters

Enter the parameter menu, when the cursor blinks over T in the upper right; press SEL to enter the editing mode, and press SEL continuously, when the following functional block parameters are displayed in Ladder mode: T → C → R → G → AS → MD → PI → MX → AR → MU → T...

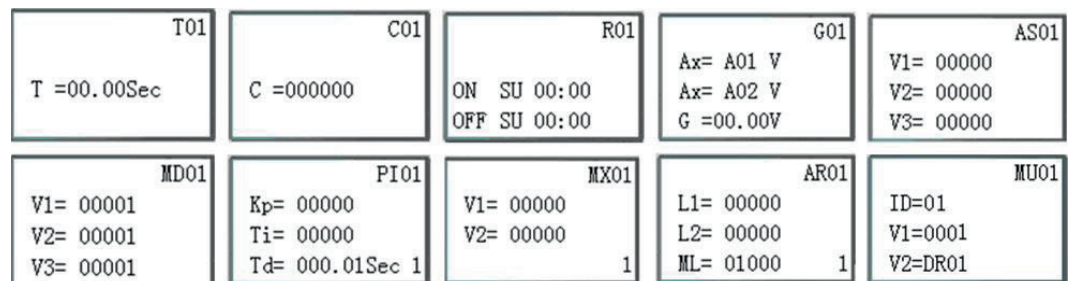

Functional blocks PI and AR are available for the following key operation:

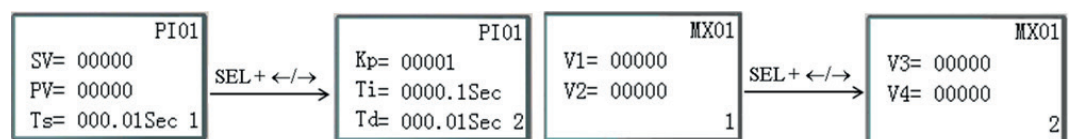

In FBD mode, the used Block parameters are displayed in proper order.

◎ Run or Stop

(1) RUN Mode

Run
Yes
> No

(2) STOP Mode

Stop
Yes
> No

↑ ↓	Move the cursor
OK	Return to main menu after execution of instruction
ESC	Return to main menu

◎ DR register

The preset value of DR is displayed in the stop mode, and the current value of DR displayed during running.



↑ ↓ ← →	Move the cursor
OK	Confirm the operation
SEL	Enter editing mode (for modification of DR display number or preset value)
SEL+SEL	Edit the preset value of DR and modify value type
SEL+ ↑ ↓	1. Change the current display number of DR (first row) 2. Modify the preset value of DR
ESC	1. Cancel the current editing 2. Return to main menu when DR is browsed (save the edited data)
SEL+ ↑ / ↓	4 lines of program skipped after each press (page turning)

◎ Other menu items

- (1) Clear program (clear RAM and password)
- (2) PLC->SD card: Write program in LRK into SD card
- (3) SD card ->PLC: Read program stored in SD card into LRK

The following keys can be used for items (1)~ (3):

↑ ↓	Move the cursor
OK	Execute instruction
ESC	Return to main menu

(4) System setting

	content	default		
ID SET	ID SET	01	➔	ID setting (00~99)
REMOTE I/O	REMOTE I/O	N	➔	Remote I/O Mode (N: none M: Master S: Slave)
BACK LIGHT	BACK LIGHT	×	➔	Back light mode (√: always light ×: light for 10s after pressed.)
M KEEP	M KEEP	√	➔	M: non-Volatile (√:Volatile ×: Non- Volatile)
I/O NUMBER	I/O NUMBER	0	➔	Setting expansion I/O module number (0-3)
I/O ALARM	I/O ALARM	√	➔	Siren setting when is not available to Expansion I/O Points (√:Yes ×:No)
C KEEP	C KEEP	×	➔	in stop/run switching, Counter Present Value Keeping (√:Yes ×:No)
Z SET	Z SET	×	➔	Enable or disable keypad input Z01-Z04 (√:enable ×:disable)
RS485 SET	RS485 SET	03	➔	Setting the form and baud rate of RS-485
DATA REG.	DATA REG.	U	➔	Setting the Data Register type (U: 16bit-unsigned S: 16bit-sign)
MEMORY SET				
M/S SET				

* When M holding function is set, status of coil M and current value of timers TOE and TOF are held in case of power failure. At this time, the following keys can be used:

↑ ↓ ← →	Move the cursor
SEL	Begin setting
SEL+ ←/→	Move the cursor for ID setting or RS485 communication setting
SEL+ 1/I	1. ID setting= 00~99; I/O module = 0~3 2. Remote I/O = N ↔ M ↔ S ↔ N 3. Backlight, C holding, Z setting = × ↔ √ 4. M holding, I/O warning = √ ↔ × 5. RS485 communication setting = (0~3) (0~5) 6. DR setting = U ↔ S
OK	Editing confirmation
ESC	1. Cancel the current setting 2. Return to main menu (save the edited data)

* When IO LINK is used, ID setting range is 0~7 and must be continuous, where ID=0 is taken as master and ID=1~7 as slave by default.
* When remote I/O is used, the master mode must be set as M (master) and slave mode as S (slave). Master remote I/O setting is as follows:

	Master		Slave
Remote input	X01~X0C	←	I01~I0C
Remote output	Y01~Y08	→	Q01~Q08

* Refer to Chapter VII: Function Specification of LRK20RD024RS Type for detailed instructions on use of remote I/O and I/O link functions.

(5) Clock setting (RTC)

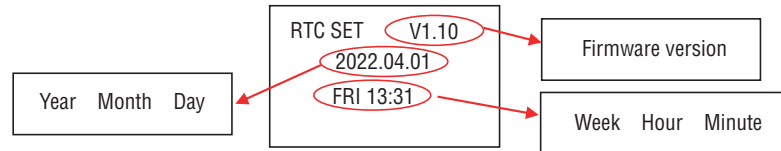

At this time, the following keys can be used:

↑ ↓	Clock setting, switching of winter/summer time setting menu
SEL	Begin parameter setting
SEL+ ←/→	Move cursor to the set item
SEL+ ↑ ↓	1. Year=00~99, month=01~12, day=01~31 2. Hour = 00~23, minute = 00~59
OK	Confirm the setting
ESC	1. Cancel the setting 2. Return to main menu

* Week is computed automatically based on the set year, month and day;
* RTC accuracy:

Temperature	Error
Normal temperature +25°C	±3 sec/day
-20°C/+50°C	±6 sec/day

RTC SUMMER TIME/WINTER TIME SETTING

LRK has built in European standard and USA standard summer time/winter time, and a group of summer time/winter time available for setting. Summer time/winter time setting can be completed by PC software LRXSW or Keypad, as shown below.

1) LRXSW software

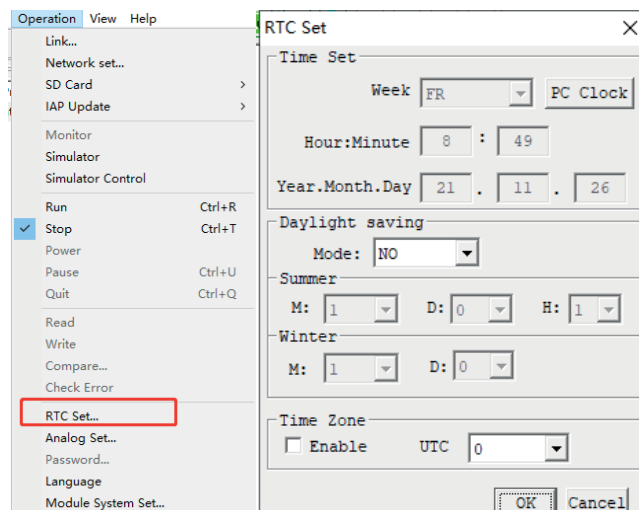

RULES OF SUMMER TIME/WINTER TIME SETTING:

- 1) Month (M) range is 1-12;
- 2) Week (D) range is 0-5, which means. 0-5th Sunday of the current month; No. 0 Sunday means the final Sunday in the current month;
- 3) Hour (H) range is 1-22; hour parameter of summer time and winter time is the same.

2) Keypad

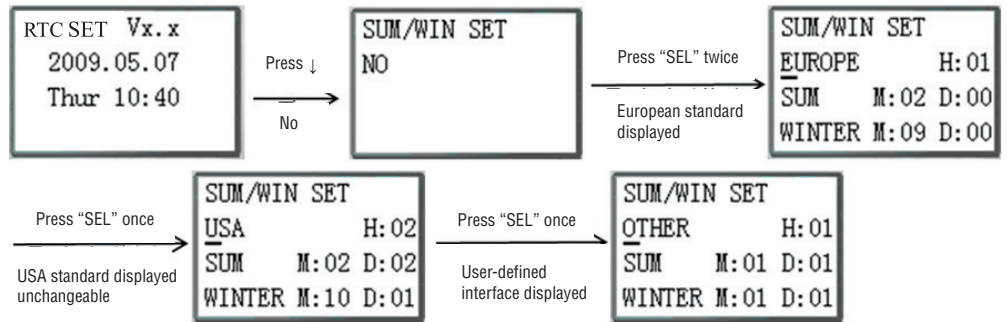

Press “→” to move cursor to the set position, press “↑” or “↓” to change the set value, and Press OK to finish the setting.

Example: 2009, SUM M: 05 D: 01 → 2009-5-3; M: 10 D: 00 → 2009-10-25.

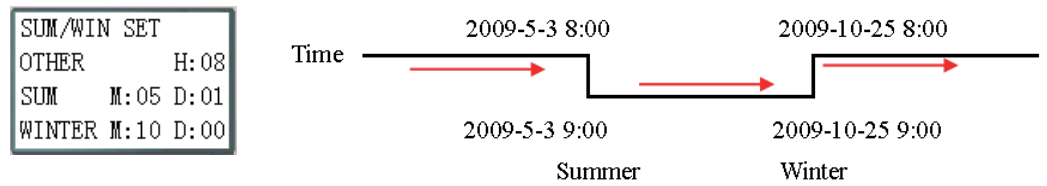

(6) Analog setting

	A 1: Gain: 010	➡	Gain (0-999), default value is 10
A01 = Gain: 010	Offset: +00	➡	Offset (-50~+50), default value
Offset: +00	A 2: Gain: 010		
A02 = Gain: 010	Offset: +00		
Offset: +00	A3-A8...Gain+ offset		

Press the following keys at this time:

↑ ↓	1. Move the cursor upward and downward 2. Switch the setting interface: A01/A02 ➡ A03/A04 ➡ A50/A06 ➡ A07/A08
SEL	Begin setting
SEL+ ←/→	Move the cursor
SEL+ ↑ ↓	1. Gain=000-999 2. Offset=-50~+50
OK	Confirm the setting
ESC	1. Cancel the current editing 2. Return to main menu (save the edited data)

* $V01 = A01 * A01_gain + A01_offset$

 $V08 = A08 * A08_gain + A08_offset$

(7) Password setting

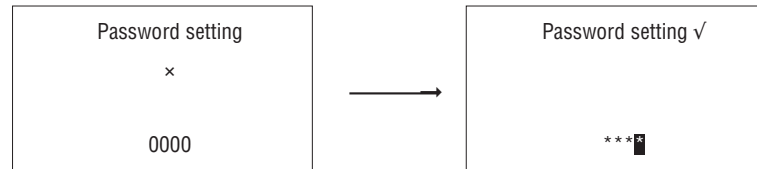

Press the following keys at this time:

SEL	1. Begin password input 2. When password is ON, 0000 is not displayed, but **** is displayed
SEL+ ←/→	Move the cursor
SEL+ ↑ ↓	Password input 0~F
OK	Saved input data not being 0000 or FFFF, PASSWORD ON
ESC	1. Cancel "SEL" input data 2. Return to main menu

- * Level A password: Password range 0001~9FFF.
- Level B password: Password range A000~FFFE.
- Password function is cleared when the set password is 0000 or FFFF.

When H coil (HMI) is enabled, passwords of levels A and B have the same access permission; when no H coil is enabled, passwords of level A and B have different access permissions. Function description of level A/B password:

Main menu	No H coil ON		H coil ON	
	Level A password	Level B password	Level A password	Level B password
Ladder diagram	✓	✓	✓	
Functional block	✓	✓	✓	
FBD	✓	✓	✓	
Parameter		✓	✓	
Run/Stop		✓	✓	
DR register		✓	✓	
Clear program	✓	✓	✓	
Write in memory card	✓	✓	✓	
Read from memory card	✓	✓	✓	
System setting		✓	✓	
Clock setting		*	*	
Analog setting		✓	✓	
Select language		✓	✓	
Program language setting	✓	✓	✓	

✓: Password protection

* Press SEL+OK to enter the clock setting menu

(8) Select language

<div style="border: 1px solid black; padding: 5px; margin-bottom: 5px;"> ENGLISH FRANÇAIS ESPAÑOL ITALIANO </div> <div style="border: 1px solid black; padding: 5px; margin-bottom: 5px;"> DEUTSCH PORTUGUES > 简体中文 ✓ POLSKI </div> <div style="border: 1px solid black; padding: 5px;"> РУССКИЙ * TÜRKÇE </div>	➔ English
	➔ French
	➔ Spanish
	➔ Italian
	➔ German
	➔ Portuguese
	➔ Simplified Chinese
	➔ Polish
	➔ Russian
	➔ Turkish

(8) Select language

↑ ↓	Move the cursor
OK	Select language
ESC	Return to main menu

* A language followed by "✓" is the current language selected;

* A language followed by "*" represents HMI language list selection, which may only be Russian or Turkish;

* Press ↑ or ↓ to move the cursor and press OK to select the language; in case of Russian or Turkish, HMI language list selection should be modified accordingly; HMI language list is not modified when it is changed to other language.

(9) Program language selection

INITIAL
> LADDER ✓
FBD

Press the following keys at this time:

↑ ↓	Move the cursor
OK	Select mode
ESC	Return to main menu



The previously stored user program will be lost when Ladder or FBD editing mode is changed!

SYSTEM ERROR DISPLAY AND ACTION

Important system modules are monitored by LRK during power-on and running. In case of abnormality, the corresponding error code is displayed on LRK LCD immediately, and the machine is stopped or warning signal is given based on severity of abnormality. The meanings of error codes and the corresponding actions are provided below:

Error code	Meaning	Corresponding action	Fault cause and solutions
ROM ERROR	System program error	LRK stopped	Contact the supplier.
Vpd ERROR	Power-off circuit error	LRK stopped	Low voltage; load the correct voltage;
PROG ERROR	User program unavailable	LRK stopped	Download the user program again
LOGIC ERROR	Logic error of FBD program	LRK stopped	Logic error of user program; modify the user program.
EXT.ERROR	Extended I/O error ("I/O" warning function may be disabled in "System setting")	LRK stopped	The extended module setting is inconsistent with actual number of links; check system setting.
COMM ERROR	485 communication error of type RS485 machine	Warning only	Communication error of LRK20RD024RS; check communication protocol.
RTC ERROR	RTC error	Warning only	Can be used continuously; contact the supplier for elimination of error.

Chapter 4 Parameter Transfer

Chapter 4 Parameter Transfer	50
Internal data type of LRK	51
Transfer of parameters out of range	52

In LRK, almost all functional blocks use the current value of other blocks as the preset value. This process is called parameter transfer. The rules and precautions of parameter transfer are introduced in this chapter.

INTERNAL DATA TYPE OF LRK

All data in LRK exists in the integer form. Take the displayed parameter "A01 = 9.99V" for example: "9.99" is stored in LRK in the integer type "999", and the decimal point is only displayed according to physical meaning of data when it is required. Similarly, AT01=56.7 is stored as 567 in LRK in the integer type; AQ01=3.37V is stored as 337 in LRK in the integer type. When AT01 and AQ01 are transferred as parameter to another functional block as the preset value, only the integers "567" and "337" are transferred essentially. After being transferred as preset value of other functional block, these integers will be automatically added with decimal point based on physical meaning of the block.

Example 1:

Current value of A05 is transferred to another functional block as the preset value: A05=2.34V is transferred to another functional block as the present value, which is automatically displayed as 2.34V when transferred to AQ01 and B001(G01), as 2.34s when transferred to B002 (T01 time base 0.01s), as 23.4s when transferred to B003 (T02 time base 0.1s), and as 234s when transferred to B004 (T03 time base 1s) and B005 (C01).

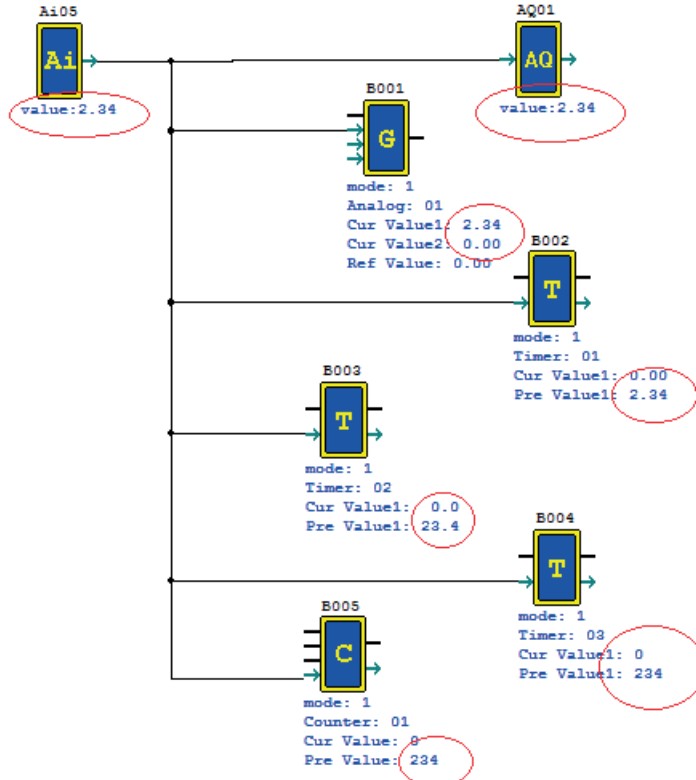

Example 2: Current value of MD is transferred to another functional block as the preset value.

It is simulated that B006(MD01)=430 and 430 is transferred as preset value to other functional blocks, where AQ01 is automatically 4.30v, B001(G01) is 4.30, B002 (T01 timing setting 0.01s) is 4.30s, B003 (T02 timing setting 0.1s) is 43.0s, B004 (T03 timing setting 1s) is 430s and B005(C01) is 430.

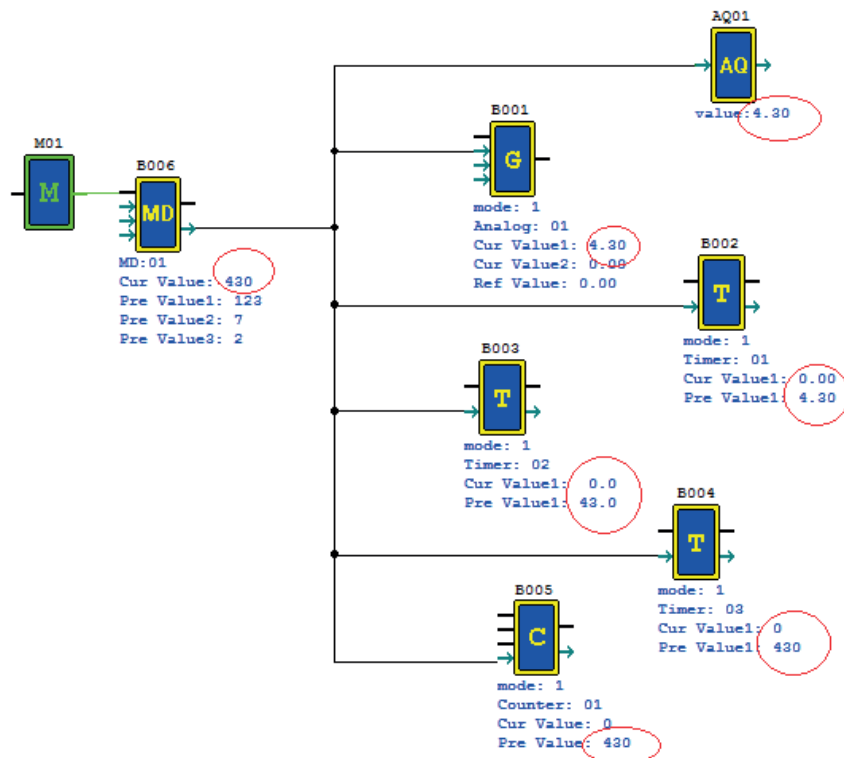

TRANSFER OF PARAMETERS OUT OF RANGE

Assuming the current value of MD (range -32768~32767) is transferred to T (range 0~9999) as the preset value. Obviously, the current value of MD may be higher than the upper limit of preset value of T or lower than the lower limit of the preset value. Under this condition, LRK will take the upper or lower limit applying the preset value of T as T preset value. This method is used in LRK under other similar conditions.

Example 3:

B006(MD01)=30000 is transferred to other functional blocks as the preset value.

When transferred to B002 (T01 time base 0.01s) as the preset value, it is automatically 99.99 as 30000 is higher than the upper limit 9999 of the preset value of T01;

When transferred to B003 (C01) as the preset value, it is automatically 30000 as 30000 is within the range of C01; When transferred to B004 (AR01) as the preset value, it is automatically 20000 as 30000 is higher than the upper limit 20000 of AR01.

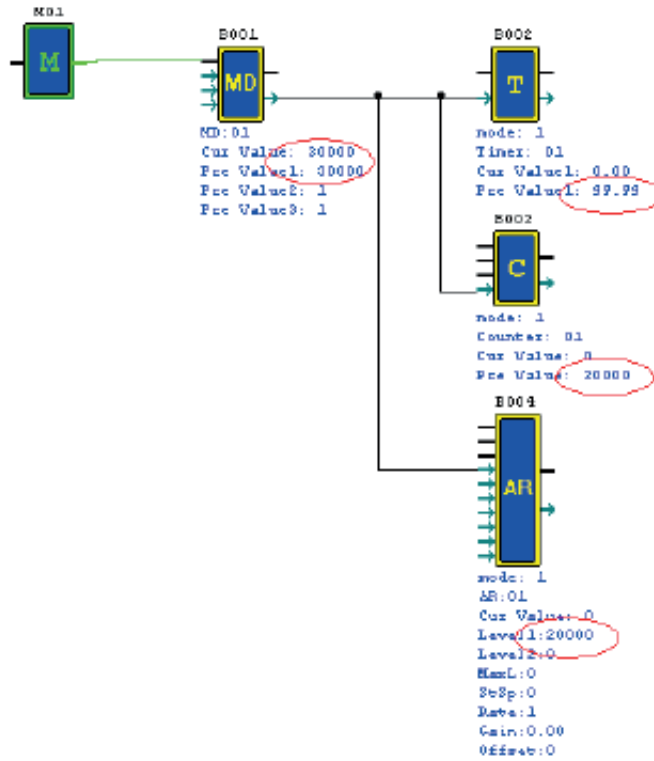

Example 2:

Given AT01=-100.0, and internal value -1000 of AT01 is transferred to other functional blocks as the preset value. When transferred to B002 (T01 time base 0.01s) as the preset value, it is automatically 00.00 as -1000 is lower than the lower limit 0 of T01;

When transferred to B003 (C01) as the preset value, C01 preset value is automatically 0 as -1000 is lower than the lower limit of C01;

When transferred to B004 (AR01), AR01 preset value is automatically -1000 as -1000 does not exceed the lower limit -10000 of AR01.

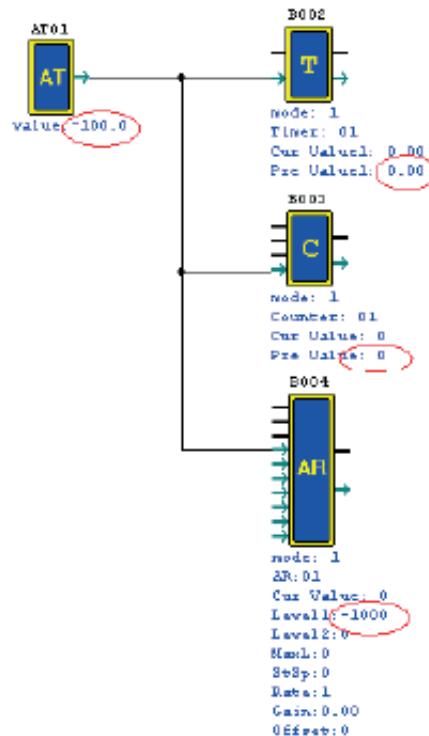

Chapter 5 Ladder Programming Instructions

Chapter 5 Ladder Programming Instructions	53
Basic Elements	54
Special Functional Instructions	57
Output Instructions	58
Analog Instructions	59
Timer Instructions	60
Counter Instructions	69
Real-time clock (RTC) Instructions	79
Analog Comparator Instructions	87
Filter Instructions	89
HMI Instructions	92
IO Link/Remote IO Instructions (for LRK20RD024RS type only).	94
MU (Modbus) Instructions (for LRK20RD024RS type only)	98
SHIFT Instructions	106
AQ Analog Output Instructions	107
AS (Addition and Subtraction) Instructions	109
MD (Multiplication and Division) Instructions	110
PID Instructions	111
MX (Multiplex Controller) Instructions	114
AR (Ramp Function Generator) Instructions	115
DR (Data Register) Instructions	119

BASIC ELEMENTS

	General output	Set output	Reset output	Pulse output	Normally open (NO) contact	Normally closed (NC) contact	Quality and number
Symbol	[^	∇	P			(N.O./N.C.)
Digital Input					I	i	12(I01-I0C/i01-i0C)
Keypad Input					Z	z	4(Z01-Z04/z01-z04)
Digital Output	Q	Q	Q	Q	Q	q	8(Q01-Q08/q01-q08)
Auxiliary Coil	M	M	M	M	M	m	127(M01-M7F/m01-m7F)
Auxiliary Coil	N	N	N	N	N	n	127(N01-N7F/n01-n7F)
Counter	C				C	c	31(C01-C1F/c01-c1F)
Timer	T			T	T	t	31(T01-T1F/t01-t1F)
Network Input					J	j	63(J01-J3F/j01-j3F)
Network Output	K	K	K	K	K	k	63(K01-K3F/k01-k3F)

Digital input I

Based on point of different machine types, LRK digital input I is 6, 8 or 12 points.

* The latter 4 inputs I09-I0C of 12-point input type are analog input, which correspond to A01-A04.

Key input Z

LRK key input Z is also digital input. For LRK... type (excluded LRK...B), the input point is 4 when Z is set effective and key input is enabled.

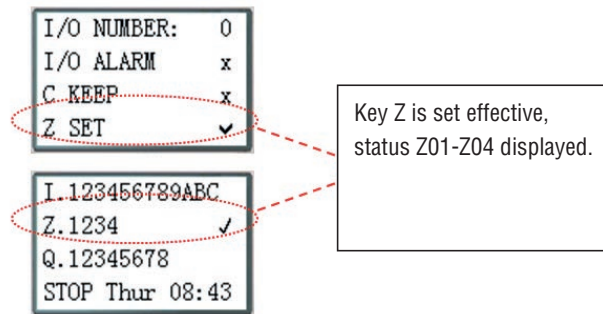

Digital output Q

Based on point of different machine types, LRK digital output Q is 4 or 8. In the following example, Q01 output is ON when I01 is ON. The digital output Q is for on-off control of Q01-Q08.



Auxiliary contact M

As internal digital coil, the auxiliary coil M is not physical input/output coil, thus it is not controlled by peripheral equipment (such as switch, sensor and relay), and can be used for control of logic program. Its number of points is 127. Program can be used as digital input (contact) or digital output (contact). In the following example, in the first line, M01 is output coil and set ON when I02 is enabled ON; in the second line, M01 is input coil, and output coils Q02 and Q03 are set ON when M01 is ON.

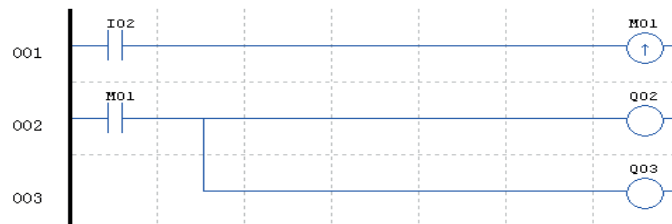

* In case of power failure of LRK, status of coil "M01~M7F" is kept if "M Keep" is effective. "M Keep" can be set by the following two means.

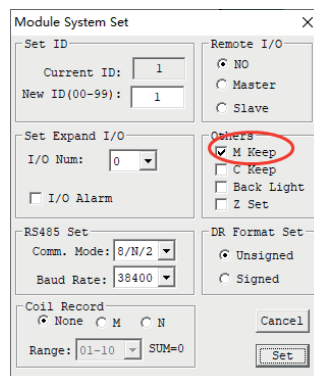

Auxiliary contacts M31–M3F as special auxiliary contact

No.	Meaning	
M31	User program start icon	User program outputs ON in the first scanning cycle and is reset after the first program execution cycle; M31 is used as general coil in subsequent cycles.
M32	1second blinking output	0.5s ON, 0.5s OFF
M33	Summer/Winter output	Output ON when summer time switching, and output OFF when winter time switching; M33 can be used as general coil.
M34	AT01 flag	Output ON in case of error in channel I of extended temperature module LRE04PD024
M35	AT02 flag	Output ON in case of error in channel II of extended temperature module LRE04PD024
M36	AT03 flag	Output ON in case of error in channel III of extended temperature module LRE04PD024
M37	AT04 flag	Output ON in case of error in channel IV of extended temperature module LRE04PD024
M38	RS485 receiving icon	Output ON when RS485 receives data
M39	Network communication port receiving icon	Output ON when network communication port receives data
M3A	Counter direction flag	Counter mode9 “high speed input counter”
M3B	Reserved	
M3C	SMTP sending email	LRK sends an E-mail each time when it is in the rising edge of M3C point
M3D	Receiving completed	Used for MODBUS instruction (MU instruction)
M3E	Error indication	
M3F	Timeout judgment	

Auxiliary contact N

Auxiliary contact N is the same as the auxiliary contact M, but status of coil N is not kept in case of power failure, and there is no special auxiliary contact. The effect is the same if M is changed to N in the above example.



Timer status coil T

Status of coil T depends on the relation between current value and preset value of timer. Coil T is set ON when the current value of timer is higher than or equal to the preset value. In the following example, I03 is set ON to enable timer T01, and when the current value of timer is greater than or equal to 5s (preset value), coil T01 is set ON to enable digital output Q01.



Counter status coil C

Status of coil C depends on the relation between current value and preset value of counter. Coil C is set ON when the counter is set to count up and its current value is greater than or equal to the preset value, or set OFF when the counter is set to count down and its current value is 0. In the following example, the counter direction is decided by coil M09 (refer to Counter Instruction) and coil M02 is reset. Assuming the counter is set to count up, when the count of I04 rising edge recorded by C01 reaches the preset value 2, coil C01 is set ON to make Q05 output ON and enable M02. After M02 is set ON and counter C01 is reset, both the current value and coil status are reset to 0.



Network input J

J is a remote I/O configured through network, as described in chapter 11. Network input J can only be used as input coil, the status of which is decided by status of remote I/O. As shown below, Q1 and Q2 are set ON after J01 is enabled.

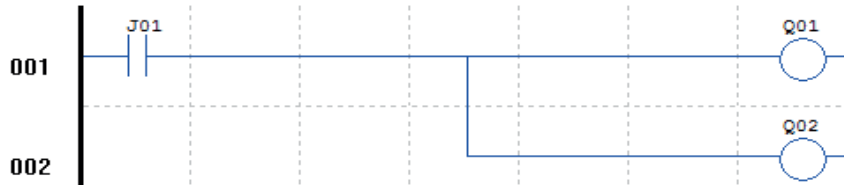

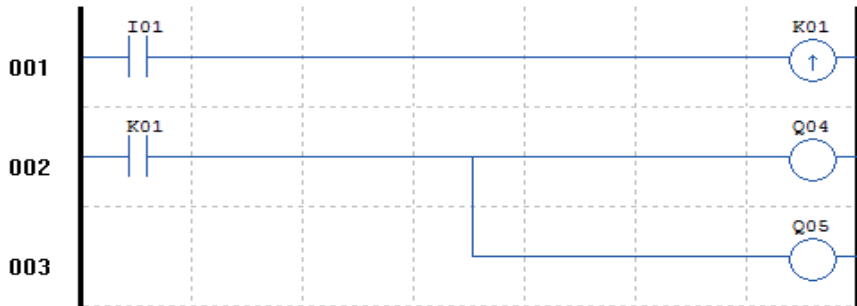

Network output K

K is a remote I/O configured through network, as described in chapter 11. Network output K can only be used as output coil, the status of which is transferred through network to remote I/O.



SPECIAL FUNCTIONAL INSTRUCTIONS

	Basic output	Set output	Reset output	Pulse output	NO contact	NC contact	Quality and number
Symbol	[^	v	P			(N.O./N.C.)
Digital Input					Lo	Hi	For functional block use
Extended input coil					X	x	12(X01-X0C/x01-x0C)
Extended output coil	Y	Y	Y	Y	Y	y	12(Y01-Y0C/y01-y0C)
Differential					D	d	
Real-time clock (RTC)	R				R	r	31(R01-R1F/r01-r1F)
Analog comparator	G				G	g	31(G01-G1F/g01-g1F)
HMI	H						31(H01-H1F)
PWM	P						2(P01-P02)
IO LINK	L						8(L01-L08)
SHIFT	S						1(S01)
F	F						31(F01-F1f)

Positive Edge Trigger - Pulse Output (D)

When the contact of codifferential instruction changes from OFF to ON, codifferential instruction will output ON and maintain a scanning cycle. As shown below, when I01 changes from OFF to ON, D outputs ON and maintains a scanning cycle, and Q01 output is set ON in a scanning cycle.

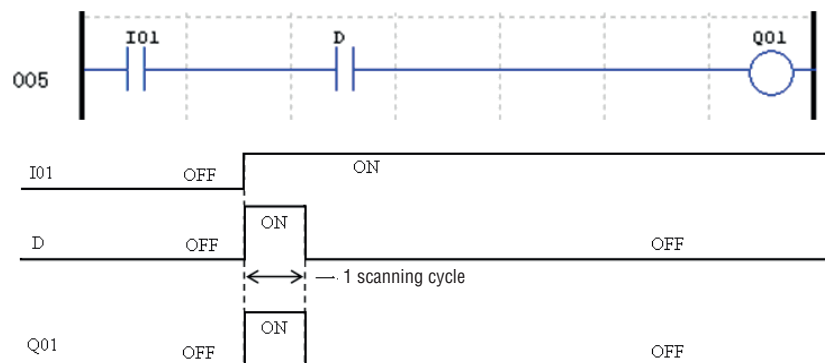

Negative Edge Trigger - Pulse Output (d)

When the contact of subdifferential instruction changes from ON to OFF, subdifferential instruction will output ON and maintain a scanning cycle. As shown below, when I01 changes from ON to OFF, d outputs ON and maintains a scanning cycle, and Q01 outputs ON in a scanning cycle.

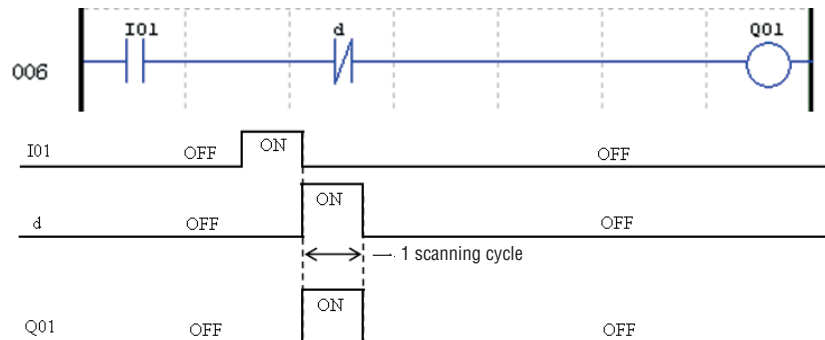

OUTPUT INSTRUCTIONS

Set output instruction (A)

When the control condition of set output instruction (SET instruction) changes from OFF to ON, the instruction controls and maintains coils Q and M ON, it is not required to keep the control condition ON afterwards, and output Q or M keeps ON till it is controlled by other output instruction.

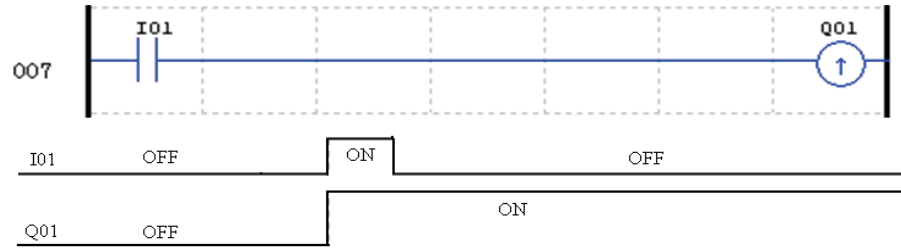

Reset output instruction (V)

When the control condition of reset output instruction (RESET instruction) changes from OFF to ON, the instruction controls and maintains coils Q and M OFF, it is not required to keep the control condition ON afterwards, and output Q or M keeps OFF till it is controlled by other output instruction.

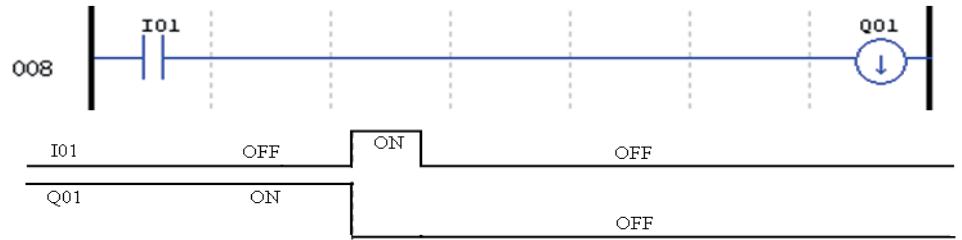

Pulse Output Instruction (Flip-Flop) (P)

When the control condition of pulse output instruction changes from OFF to ON, the instruction controls and maintains coils Q and M ON, and when the control condition changes from OFF to ON again, it controls and maintains coils Q and M OFF, and so forth. In the following example, Q04 output is ON when coil I03 changes from ON to OFF, and the output is OFF when coil I03 changes from ON to OFF.

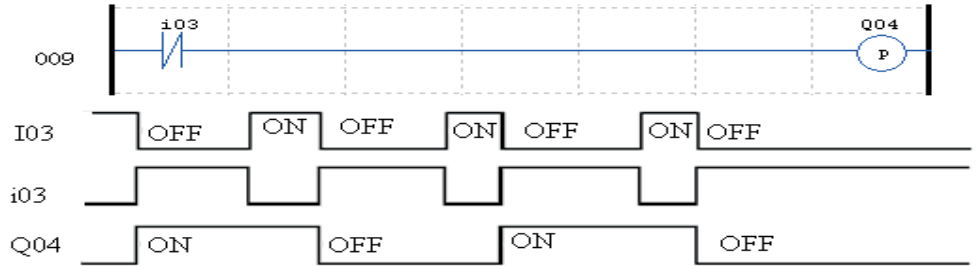

Filter status coil F

Status of filter status coil F depends on filtering condition. When filter meets the filtering condition, the current value of the functional block is updated, the current value of filter is the filtering result, and the filter coil is set ON. As shown below, after coil M01 is enabled, coil F01 outputs and the current value is updated every 10s.



ANALOG INSTRUCTIONS

	Analog input	Analog output	Quantity and number
Analog input	A		8 (A01~A08)
Analog input parameter	V		8 (V01~V08)
Temperature input	AT		4 (AT01~AT04)
Analog output		AQ	4 (AQ01~AQ04)
Add-Subtract control	AS	AS	31 (AS01~AS1F)
Multiply-Divide control	MD	MD	31 (MD01~MD1F)
PID control	PID	PID	15 (PI01~PI0F)
Data Multiplexer control	MX	MX	15 (MX01~MX0F)
Analog Ramp control	AR	AR	15 (AR01~AR0F)
Data Register	DR	DR	240 (DR01~DRF0)
MODBUS			15 (MU01~MU0F)
Network analog input	NI		31 (NI01~NI1F)
Network analog output		NQ	15 (NQ01~NQ0F)

The current value of analog quantity (A01~A08, V01~V08, AT01~AT04, AQ01~AQ04) and functional blocks (T01~T1F, C01~C1F, AS01~AS1F, MD01~MD1F, PI01~PI0F, MX01~MX0F, AR01~AR0F, DR01~DRF0, NI01~NI1F, NQ01~NQ0F) may be used as preset value of functional block parameter; when the current value exceeds the parameter range, the limit value is taken as the preset value of the corresponding parameter.

TIMER INSTRUCTIONS

LRK includes 31 independent timers. If "M KEEP" is set effective, the current values of TOE and TOF are kept in case of power failure. The timers have 8 working modes, and each timer has 6 configuration parameters to realize the 9 modes of timer (mode 0- mode 8). The definitions of 6 timer parameters and available coil types are listed below.

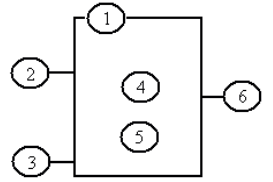

Symbol	Function	
①	Timer mode (0-8)	
②	Timing unit	Timing range
	1: 0.01s	0.00 - 99.99 s
	2: 0.1s	0.0 - 999.9s
	3: 1s	0 - 9999s
4: 1min	0 - 9999 mins	
③	ON: Timer reset as 0	
	OFF: Timer running continuously	
④	Current value of timer	
⑤	Preset value of timer	
⑥	Timer code (T01-T1F: 31 timers in total)	

Available coil type	Range
Digital input	I01-I0C/i01-i0C
Key input	Z01-Z04/z01-z04
Digital output	Q01-Q08/q01-q08
Auxiliary contact	M01-M7F/m01-m7F
Auxiliary contact	N01-N7F/n01-n7F
Extended input	X01-X0C/x01-x0C
Extended output	Y01-Y0C/y01-y0C
RTC	R01-R1F/r01-r1F
Counter coil	C01-C1F/c01-c1F
Timer coil	T01-T1F/t01-t1F
Analog comparator coil	G01-G1F/g01-g1F
NO contact	Lo
Filter coil	F01-F1F/f01-f1F
Network input coil	J01-J3F/j01-j3F
Network output coil	K01-K3F/k01-k3F

- * The preset value of timer may be a constant or code of other data type.
- * When M-KEEP is effective, the current values of TOE and TOF are kept in case of power failure.

TIMER MODE 0 (INTERNAL COIL)

The timer of mode 0 is used as internal auxiliary coil similar to M/N coil, which does not have a preset value. As shown below, timer T01 is in mode 0. Output status of timer 1 varies with status of I01.

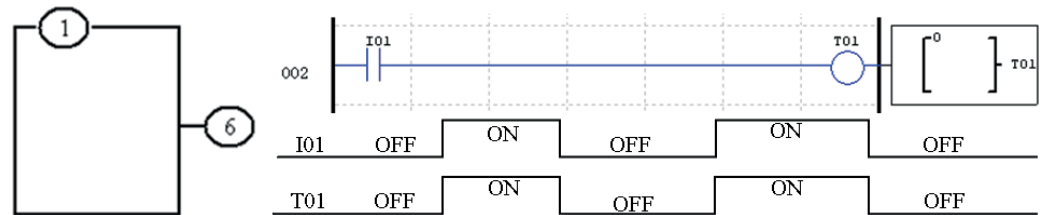

TIMER MODE 1 (ON DELAY A)

Timer begins timing when the control condition of timer mode 1 (ON Delay A) changes from OFF to ON, and it stops timing and the timer coil output is ON when the current value of timing reaches the preset value. The current value of timer and coil status are reset to 0 when the control condition of timer is OFF.

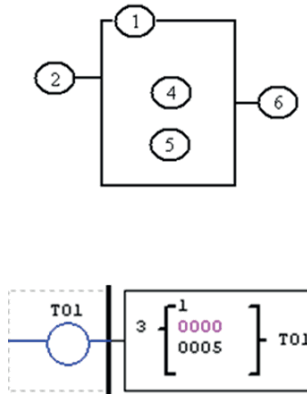

X

Edit Contact/Coil

Y | K | M | N | T | C

Timer: T 01 (01-1F) Symbol

Output Type: -I Reset Set P

Function: Mode 1 (0-6: -, 7: P)
On-delay timer mode 1

Time Base: 1SEC

Current Value: SEC

Preset Value: 0005 SEC

Preset Type: N

Direction Set: Contact

Reset Input: Contact

OK Cancel

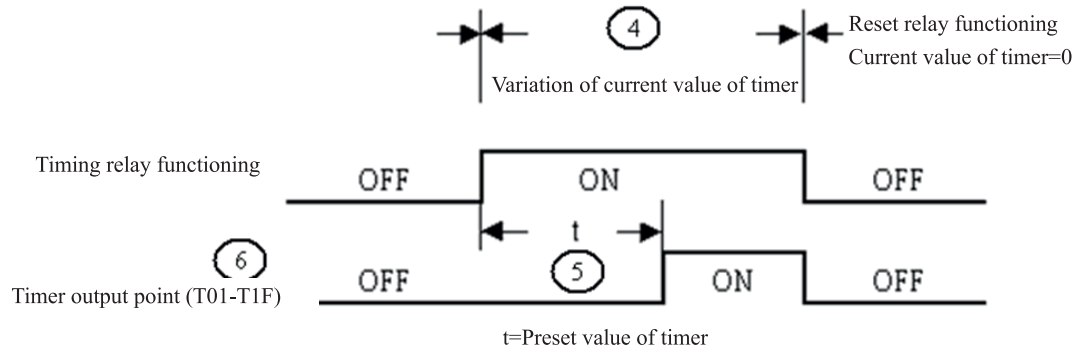

* When "M Keep" is effective, the current values of TOE and TOF are kept in case of power failure.

TIMER MODE 2 (ON-DELAY WITH RESET)

Timer mode 2 (ON Delay B) is designed with reset control. The timer begins timing when the control condition turns from OFF to ON, the current value of timer is kept when the control condition is OFF, and output coil is ON and timing is stopped when the current value of timer reaches the preset value. The current value of timer and coil status are reset to 0 when reset control is effective. In the following example, timing is stopped, output coil T01 is set ON and the current value is kept at 5 when the current value of timer T01 reaches the preset value 5. The current value and coil are reset to 0 when reset I01 is effective.

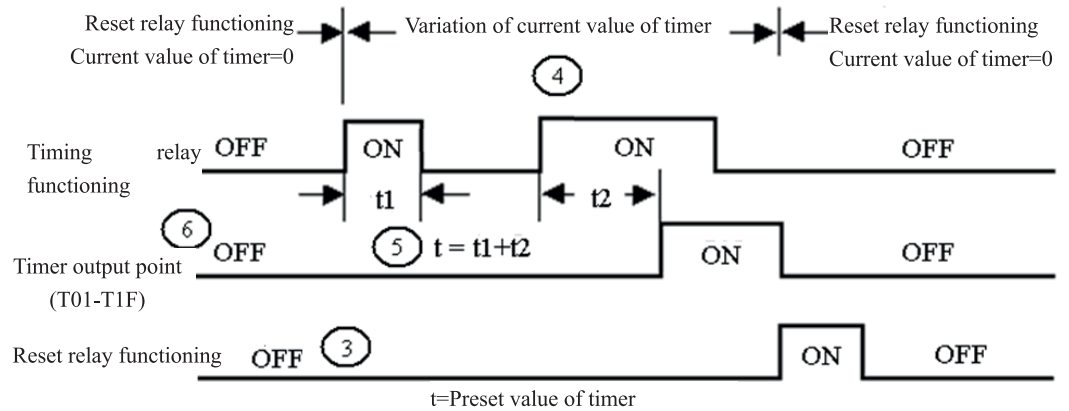
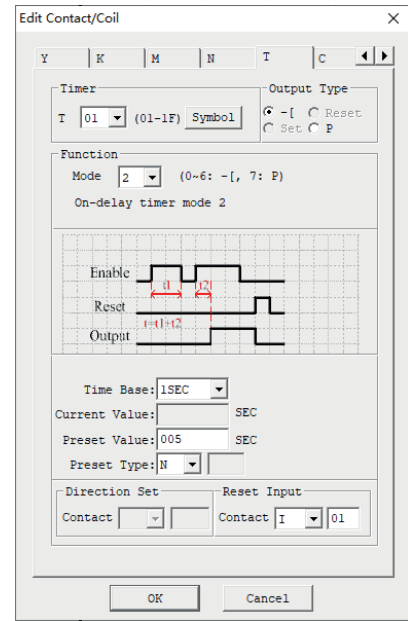
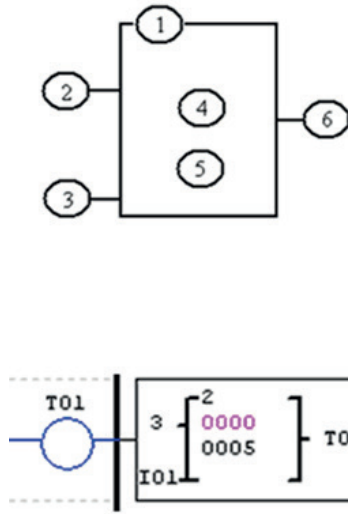

* When "M Keep" is effective, the current values of T0E and T0F are kept in case of power failure.

TIMER MODE 3 (OFF DELAY A)

Timer mode 3 (OFF Delay A) is designed with reset control. T output is ON but the timer does not work when the control condition turns from OFF to ON; timer is started up for timing when the control condition turns from ON to OFF; timing is stopped, the current value is reset as 0 and T output is OFF when the current value of timer reaches the preset value; the current value and coil status are reset to 0 when reset control is effective. As shown below, T01 is set ON but the timer does not work when the control condition turns from OFF to ON; the timer begins timing and T01 output keeps ON when the control condition turns from ON to OFF; timing is stopped and T01 output is OFF when the current value of timer reaches 10; the current value of T01 and coil status are reset to 0 when reset input I01 is effective.

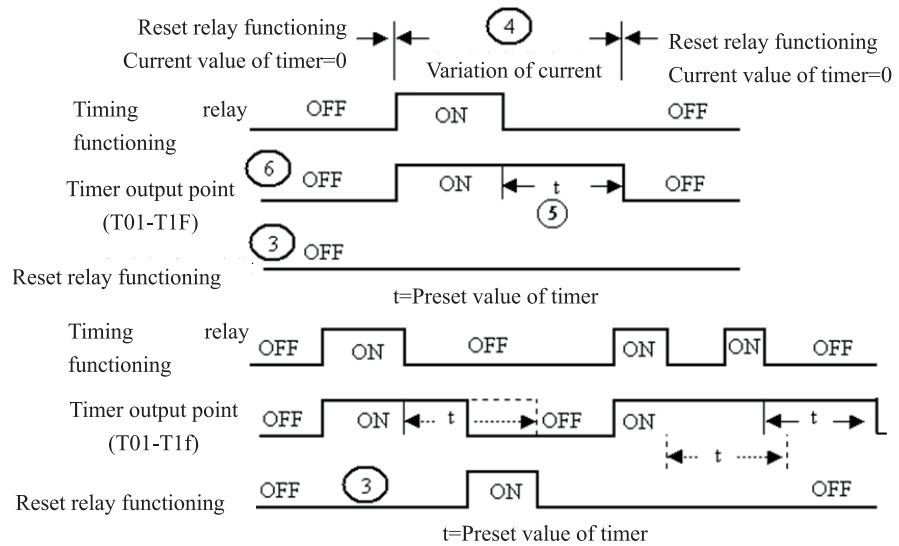
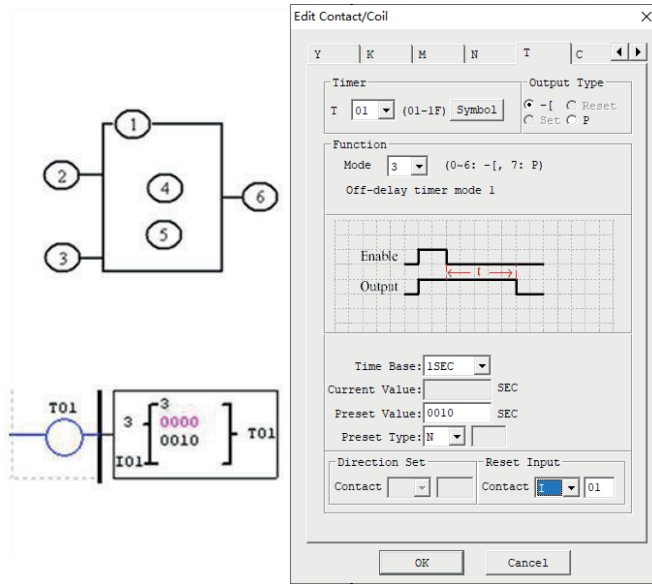

* When "M Keep" is effective, the current values of TOE and TOF are kept in case of power failure.

TIMER MODE 4 (OFF-DELAY)

Timer mode 4 (OFF Delay B) is designed with reset control. Timing is started and T output is ON when the control condition turns from ON to OFF; timing is stopped, the current value is reset and T output is OFF when the current value of timer reaches the preset value; the current value of timer and coil status are reset to 0 when reset control is effective. As shown below, the timer T01 begins timing and T01 output is ON when the control condition turns from ON to OFF; timing is stopped and T01 output is OFF when the current value of T01 reaches 10; the current value of T01 is 0 and T01 output is OFF when reset control I01 is ON.

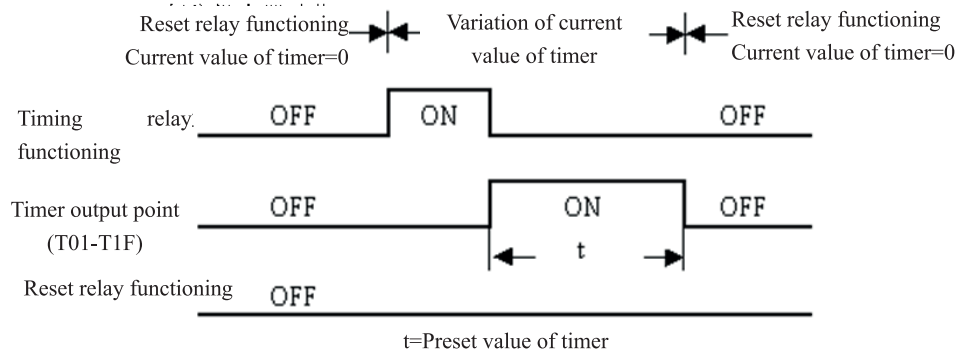
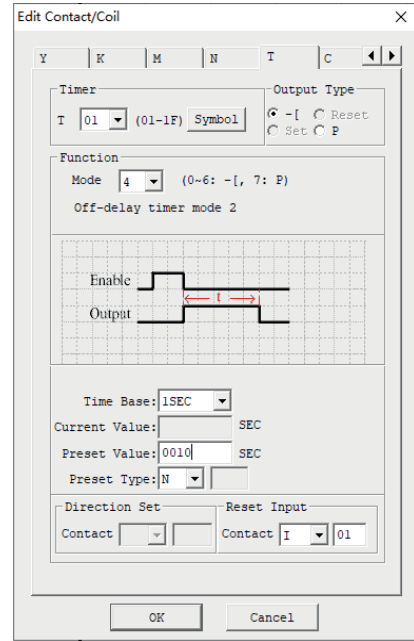
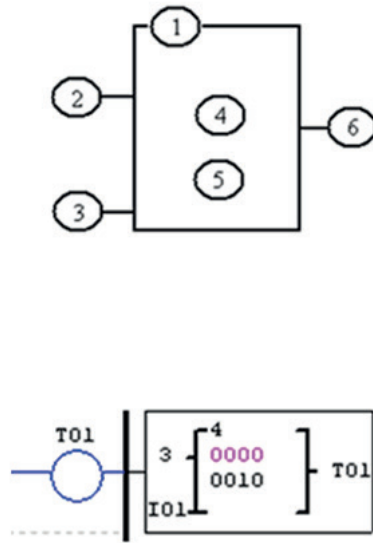

* When "M Keep" is effective, the current values of T0E and T0F are kept in case of power failure.

TIMER MODE 5 (FLASH WITHOUT RESET)

Timer mode 5 is a flash output mode without reset control. The timer begins timing when the control condition is effective; status of output coil T is shifted when the current value of timer reaches the preset value; timing is continued when the current value is reset to 0. As shown below, output status of T01 is shifted when the control condition is ON and the current value of timer reaches the preset value 10; timing is restored when the current value of T01 is reset to 0.

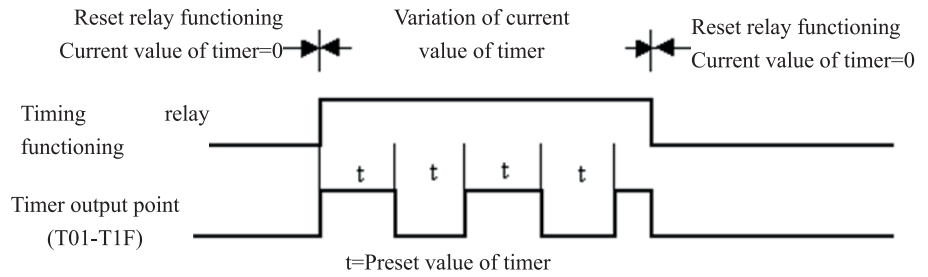
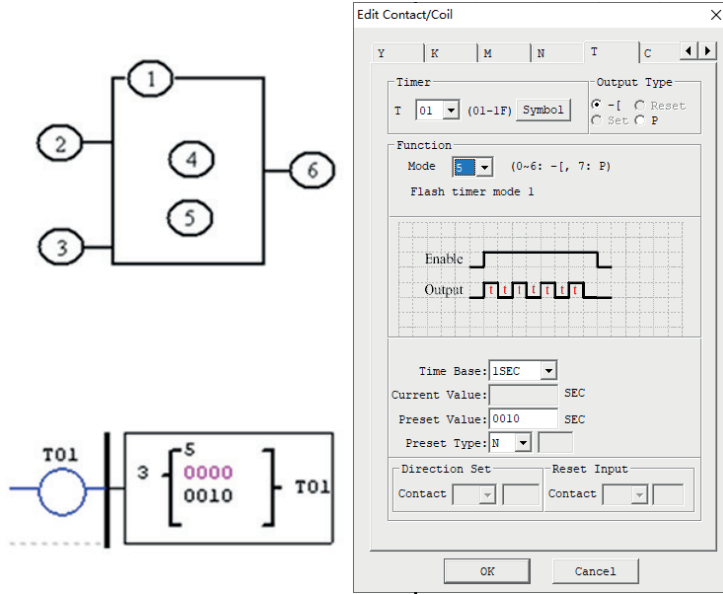

TIMER MODE 6 (FLASH WITH RESET)

Timer mode 6 is a flash output mode with reset control. The timer begins timing when the control condition turns from OFF to ON, status of output coil is shifted when the preset value is reached, and timing is continued when the current value of timer is reset to 0. In mode 6, the control condition is not required to be kept ON, and the current value of timer and output coil are reset to 0 when reset control is effective. As shown below, the timer is started up when the control condition turns from OFF to ON, output status of T01 is shifted when the current value of timer reaches the preset value 10, timing is restored when the current value is reset to 0, and the current value of T01 and coil status are reset to 0 when reset control is effective.

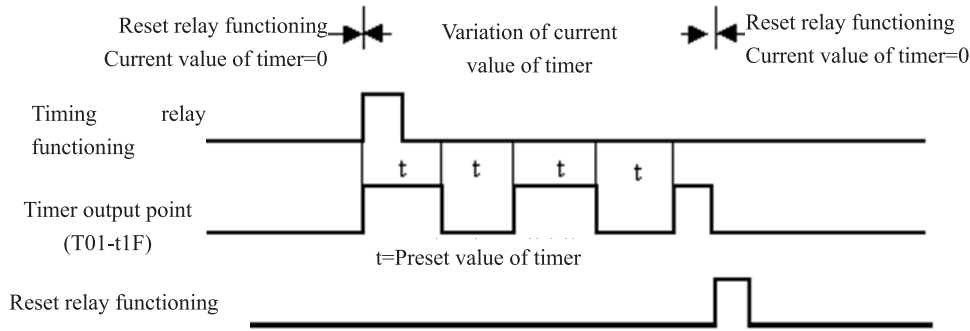
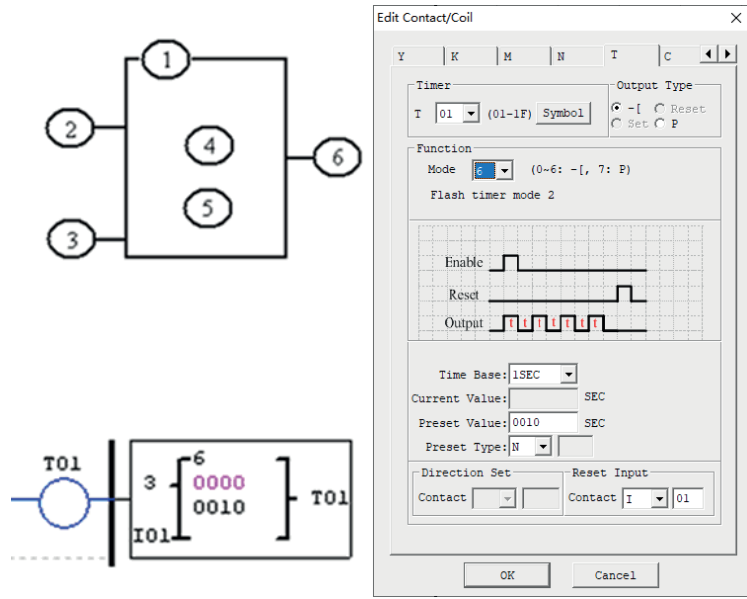

TIMER MODE 7(FLASH CASCADE WITHOUT RESET)

Timer mode 7 is a pulse output timer without reset control, which uses two timers T1 and T2. T1 begins timing and T1 output is ON when the control condition turns from OFF to ON; timing is stopped, the current value of T1 is kept, T1 output is OFF and T2 is started up when the current value of T1 reaches the preset value; timing is stopped and T2 output is ON when the current value of T2 reaches its preset value; T1 is restarted when the rising edge of T2 resets T1 and T2, namely the current value of T1 is reset as 0 and the current value of T2 and T2 coil are reset as 0. As shown below, T01 begins timing and T01 output is ON when the control condition turns from OFF to ON; T01 stops timing, the current value of T01 is kept, T01 output is OFF and T02 is started up by the falling edge of T01 but T02 output is OFF when the current value of T01 reaches the preset value 2.5s; timing is stopped and T02 output is ON when the current value of T02 reaches the preset value 1.0s; T01 is restarted when the two timers are reset by the rising edge of T02, and so forth.

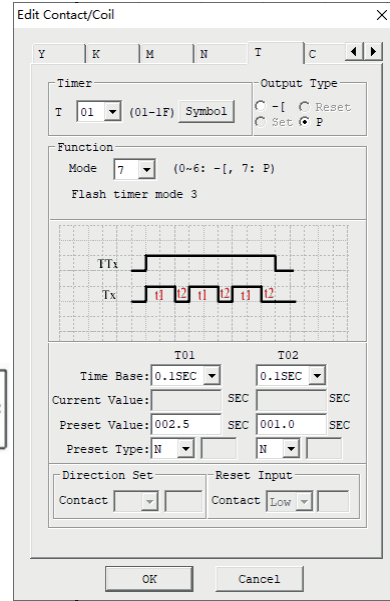
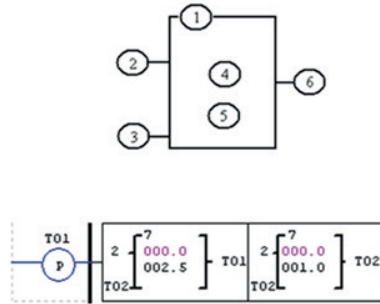

* The two timers of mode 7 cannot be used in other place of the same user project.

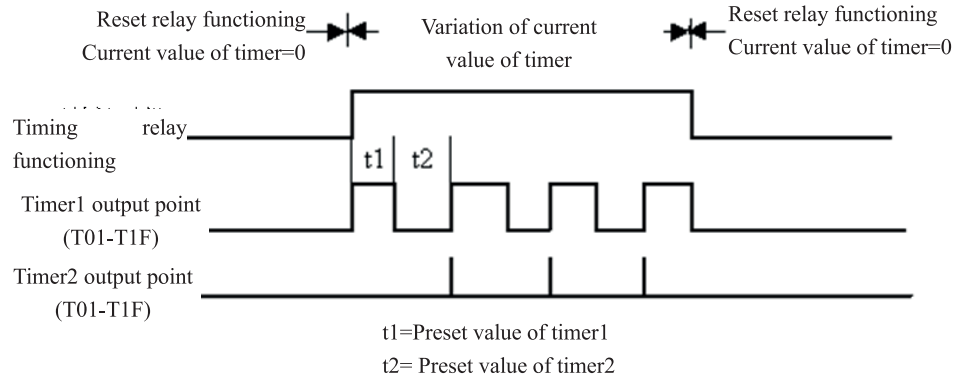

TIMER MODE 8

Timer mode 8 is a stopwatch mode with reset control and pause control. The timer begins timing when the control condition turns from OFF to ON; status of output coil is shifted, the current value of timer is displayed as the preset value and timing is discontinued when the preset value is reached; the current value of timer and output coil are reset to 0 when reset control is effective.

The current value is not updated (timing continued) when Pause input is set ON; the current value is updated (to current actual value) when Pause input is OFF; the current value is displayed as 9999 and timing is discontinued when Pause input is ON and actual value reaches the preset value.

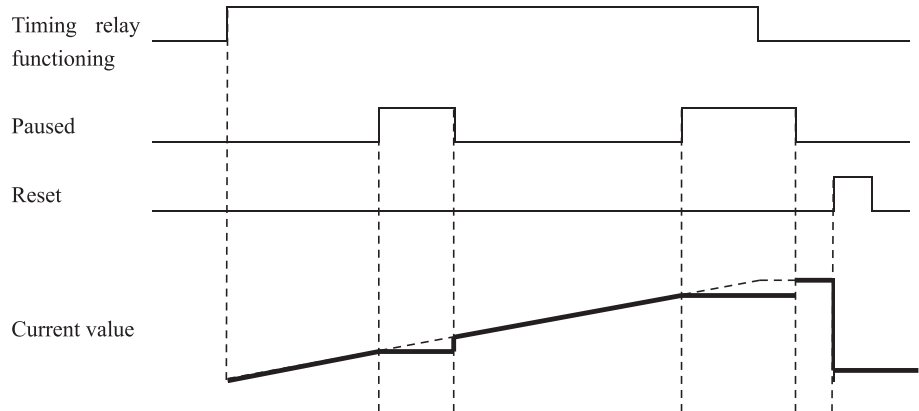
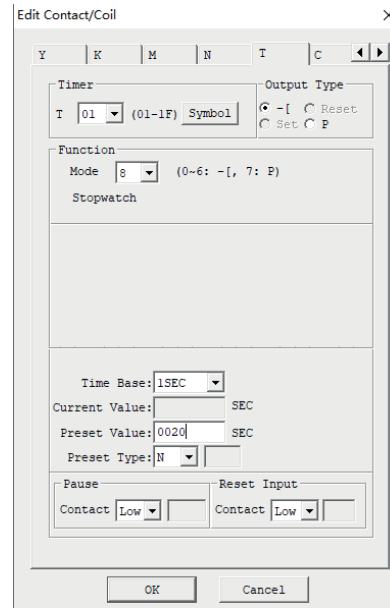
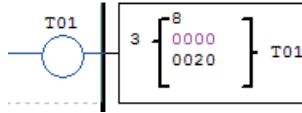
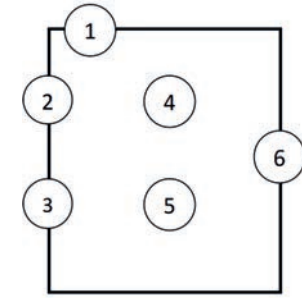

COUNTER INSTRUCTIONS

LRK has 31 independent counters. Each counter has 6 parameters and 10 working modes, 1 of which is used as internal coil, 6 as general counter and 2 as high-speed counter. The 6 parameters and available coils are listed below.

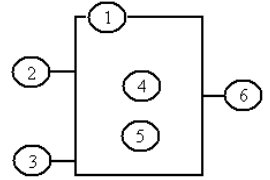

Symbol	Description
①	Counter mode (0-9)
②	Counting direction coil OFF: Count up (from 0 or current value to preset value) ON: Count down (from preset value or current value to 0)
③	Reset coil ON: Current value of counter is reset to 0, and output coil is OFF; OFF: Counter continues counting, and output coil is ON after completion of counting;
④	Current counting value of counter, range: 0-999999
⑤	Preset value of counter, range: 0-999999
⑥	Counter code (C01-C1F, 31 counters in total)

Available coil	Number
Input coil	I01-I0C/i01-i0C
Key input	Z01-Z04/z01-z04
Output coil	Q01-Q08/q01-q08
Auxiliary coil	M01-M7F/m01-m7F
Auxiliary coil	N01-N7F/n01-n7F
Extended input	X01-X0C/x01-x0C
Extended output	Y01-Y0C/y01-y0C
RTC output coil	R01-R1F/r01-r1F
Counter output coil	C01-C1F/c01-c1F
Timer output coil	T01-T1F/t01-t1F
Analog comparator output coil	G01-F1F/g01-g1F
NO contact	Lo
Filter coil	F01-F1F/f01-f1F
Network input coil	J01-J3F/j01-j3F
Network output coil	K01-K3F/k01-k3F

- * The preset value of counter may be a constant or code of other data type.
- * The following modes are described based on counting up. Counting down is from the current value to the preset value (not kept) or counting of input rising edge from the current value (kept); the current value is decreased by 1, and counting is stopped when the current value is 0; when it is reset, the current value is equal to the preset value.

COUNTER MODE 0 (INTERNAL COIL)

As the internal coil, counter mode 0 does not have a reset value, and status of counter coil varies with status of input coil, as shown below.

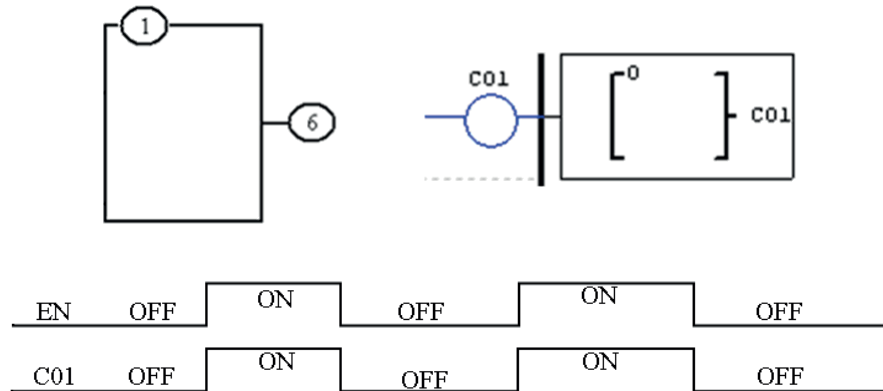

COUNTER MODE 1 (NON-OVERTAKE, NON-RETENTIVE)

The current value of counter is counted up from 0, counting is stopped and output coil is ON when the preset value is reached. In case of power failure, the current value is not kept and changes to 0 after power-on again or RUN/STOP switching. As shown below, I02 is the reset coil and M01 the counting direction coil; the counter C01 counts the input rising edge, counting is stopped and C01 output is ON after the preset value 20 is reached (if the direction coil M01 is enabled, the counter counts down from 20 after resetting, till the current value is 0; in case of power failure in this process, the current value is not kept, and counting is re-started from 20).

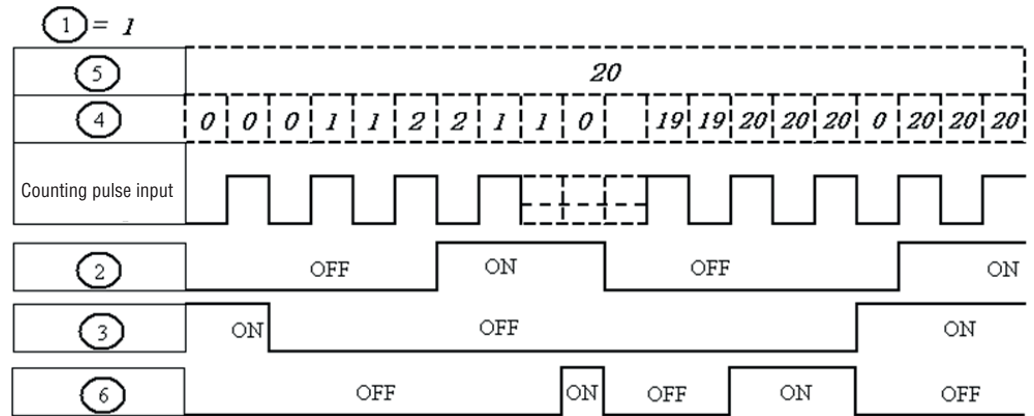
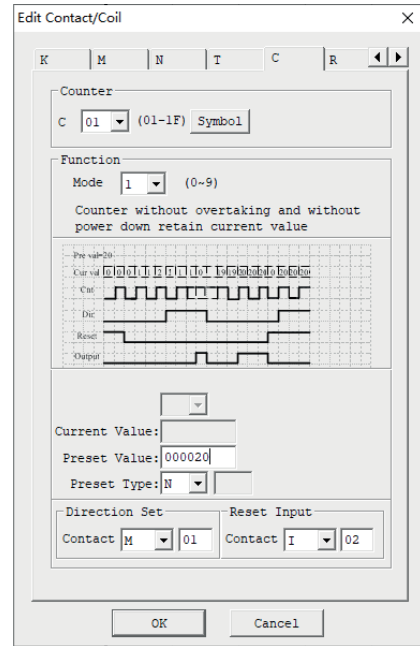
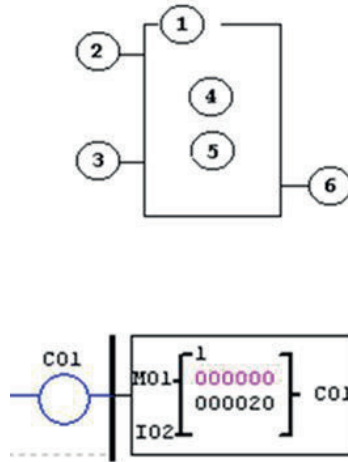

* In this mode, the current value of counter is initialized to 0 (counting up) or the preset value (counting down) after power-on or RUN/STOP switching; the current value is 0 (counting up) or the preset value (counting down) after resetting.

COUNTER MODE 2 (OVERFLOW ALLOWED, NOT KEPT)

The current value of counter is counted up from 0; after the preset value is reached, output coil is ON, but counting of input rising edge is continued till the current value is 65535. After power-on or RUN/STOP switching, the current value of counter is not kept but reset to 0. In the following example, I02 is the reset coil and M01 the counting direction coil; the counter C01 counts the input rising edge, and C01 output is ON and C01 current value increases continuously after the preset value 20 is reached.

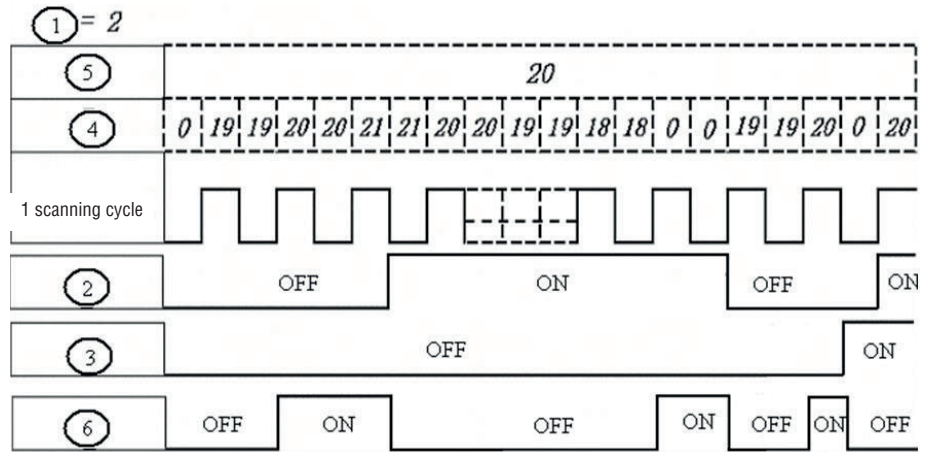
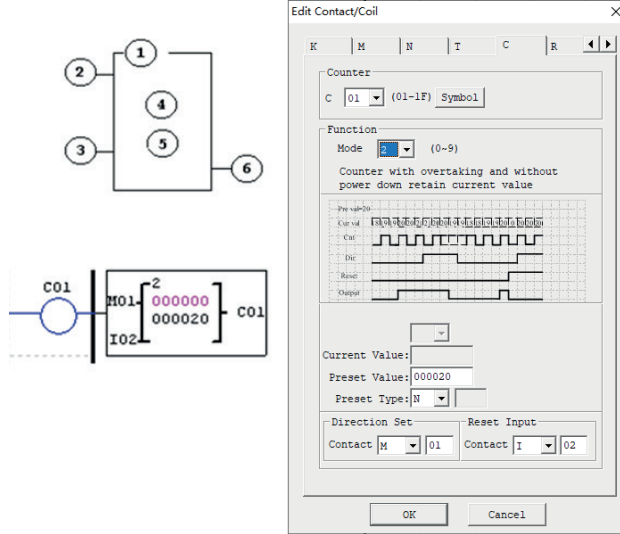

* In this mode, the current value of counter increases continuously after the preset value is reached, and initialized to 0 (counting up) or the preset value (counting down) after power-on or RUN/STOP switching. After resetting, the current value is 0 (counting up) or the preset value (counting down).

COUNTER MODE 3 (OVERFLOW NOT ALLOWED, KEPT)

The counter mode 3 is similar to mode 1, namely counting is stopped and output coil is ON when the current value reaches the preset value, but the current value is kept after power-on again. If "C KEEP" is effective, the current value is kept after RUN/STOP switching. In the following example, I02 is the reset coil and M01 the counting direction coil; counter C01 counts the input rising edge, and counting is stopped and C01 output is ON after the preset value 20 is reached.

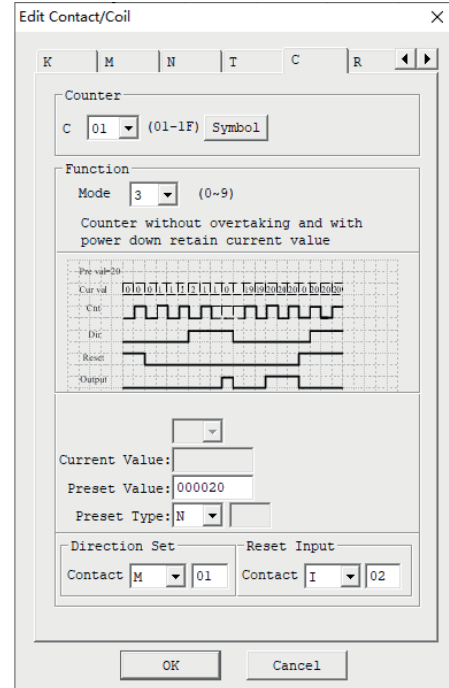
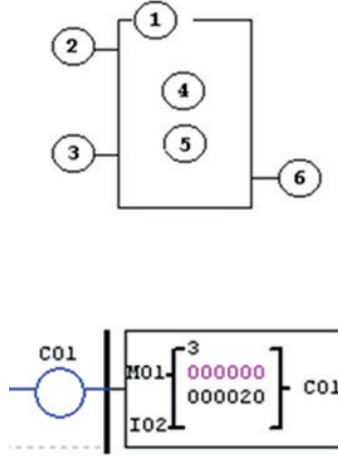

- * Mode 3 is similar to mode 1, but the current value is kept in case of power failure;
- * If C KEEP is set, the current value is kept after RUN/STOP switching.
- * The current value is 0 (counting up) or the preset value (counting down) when resetting.

COUNTER MODE 4 (OVERFLOW ALLOWED, KEPT)

The counter mode 4 is similar to mode 2, namely counting is continued after the current value reaches the preset value, but the current value is kept after power failure. If C KEEP is set, the current value is kept after RUN/STOP switching. In the following example, I02 is the reset coil and M01 the counting direction coil; counter C01 counts the input rising edge, and counting is continued and C01 output is ON after the preset value 20 is reached.

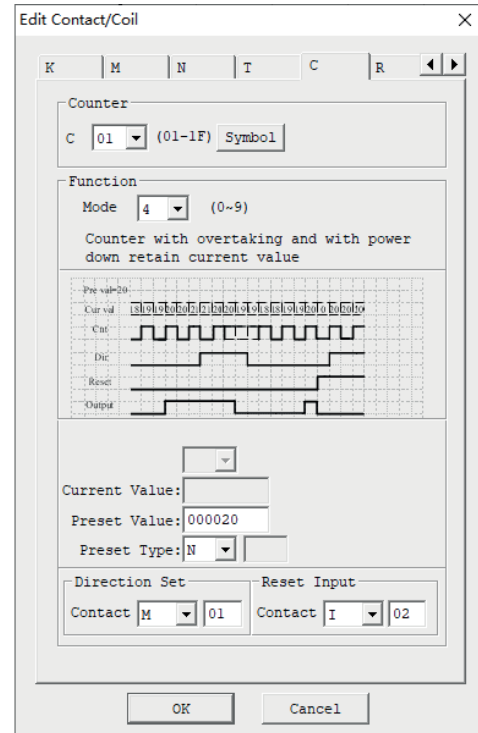
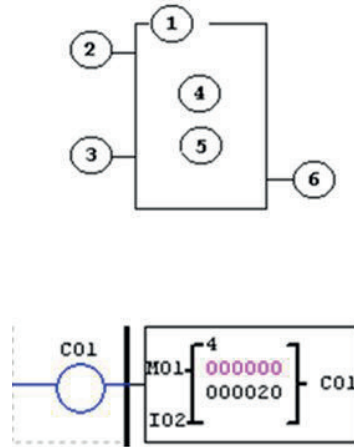

- * Mode 4 is similar to mode 2, namely counting continues after the current value reaches the preset value, but the current value is kept after power failure.
- * If C KEEP is set, the current value is kept after RUN/STOP switching.
- * The current value is 0 (counting up) or the preset value (counting down) when resetting.

COUNTER MODE 5 (OVERTAKING, UP-DOWN COUNT, NON-RETENTIVE)

The counter mode 5 is similar to mode 2, namely counting overflow is allowed, but the current value is not kept after power-on again or RUN/STOP switching. Regardless of counting direction in mode 5, output is ON only when the current value is higher than or equal to the preset value, and the current value is 0 after resetting, power failure or RUN/STOP switching. In the following example, I02 is the reset coil and M01 the counting direction coil; the counter C01 counts the input rising edge, and C01 output is ON and counting continues after the preset value 20 is reached.

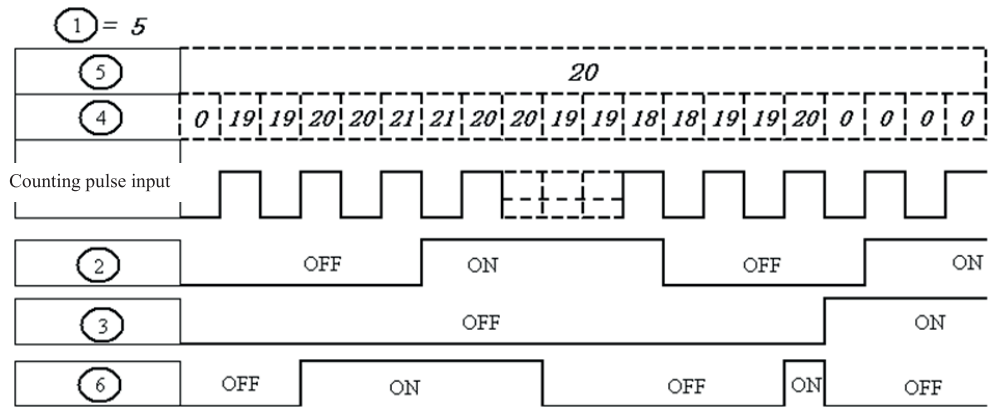
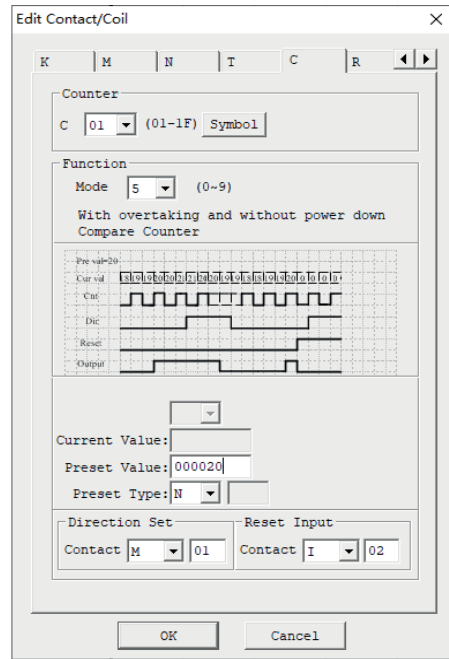
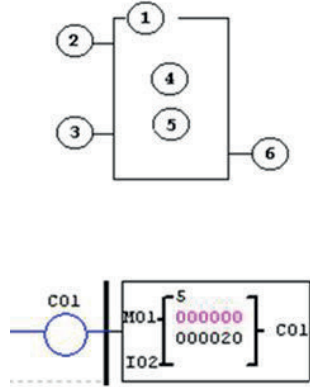

* In this mode, counting continues after the current value of counter reaches the preset value; regardless of counting direction, the current value is 0 after resetting, and not kept after power-on again or RUN/STOP switching.

COUNTER MODE 6 (OVERFLOW ALLOWED, KEPT, COMPARISON COUNTER)

The counter mode 6 is similar to mode 5, but the current value is kept in case of power failure; if C KEEP is set, the current value is kept after RUN/STOP switching. In the following example, I02 is the reset coil and M01 the counting direction coil; the counter C01 counts the input rising edge, and C01 output is ON and counting continues after the preset value 20 is reached.

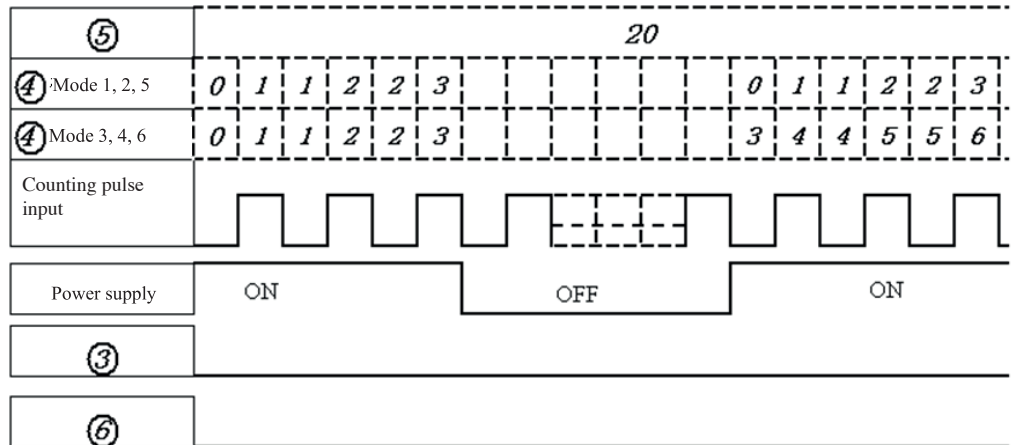
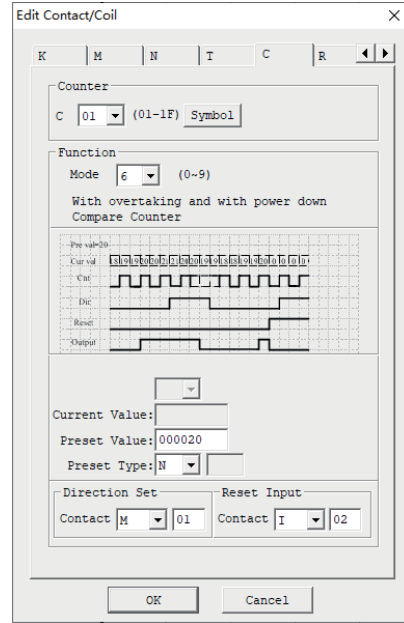
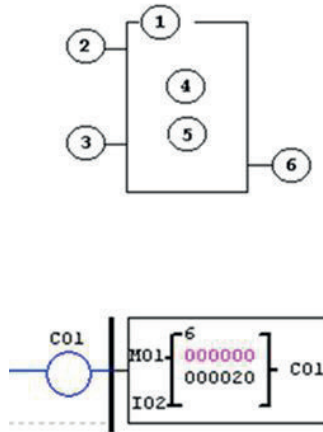

- * In mode 6, the current value is kept in case of power failure.
- * If C KEEP is effective, the current value is kept after RUN/STOP switching.

HIGH-SPEED COUNTER (FOR DC TYPE)

Micro PLC LRK with DC power supply provides two 1KHz high-speed inputs I01 and I02, and uses two counters to realize two groups of high-speed counting. Counter modes 7 and 8 are high-speed counting that uses the same editing method with general counter but has different parameters.

HIGH-SPEED COUNTER MODE 7 (PROPORTIONAL INPUT COUNTER)

In DC machine, high-speed counter mode 7 uses I01 or I02 as the maximum 1KHz high-speed input, and counting is stopped and output coil is ON after the counting value reaches the preset value. After resetting, the current value of counter is reset to 0 and output coil is OFF. In the following example, the rising edge of high-speed input I01 is counted after C01 is enabled; counting is stopped and C01 output is ON after the counting value reaches the preset value 50000; the counter C01 is reset when M05 is ON.

Symbol	Description
①	High-speed counter mode7
②	High-speed counter input, I01, I02
③	Reset coil ON: Current value of counter is reset to 0 OFF: Counter continues counting
④	Current value of counter: 0~999999
⑤	Preset value of counter 0~999999
⑥	Counter code (C01~C1F, 31 counters in total)

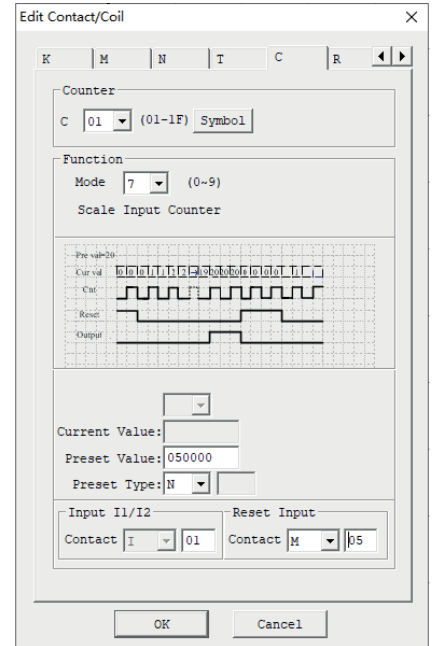
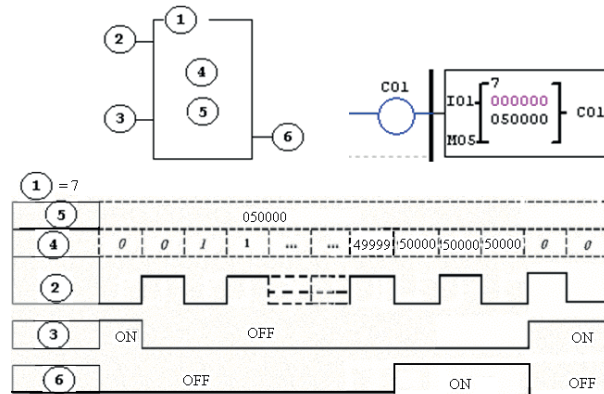

Output example:

In the following example, Q01 outputs ON immediately when C01 counting value reaches the preset value, and Q02 outputs ON only when output is executed in the scanning cycle.

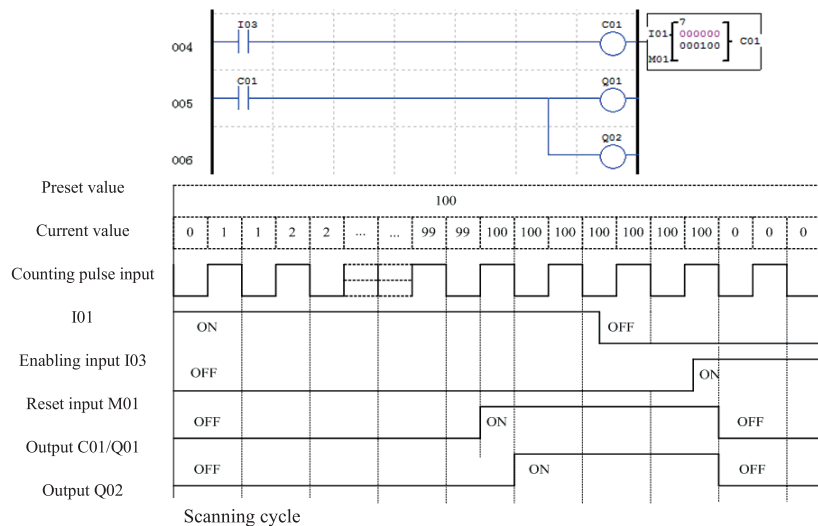

HIGH-SPEED COUNTER MODE 8 (1KHZ INPUT COUNTER) (DC POWERED VERSIONS ONLY)

The Mode 8 High Speed Counter can use either input terminals I01 or I02 for forward up-counting to 1 KHz maximum at 24VDC high speed input signal. It will refresh its counted value in each "fixed time". When the counted value reaches or exceeds the "Preset ON", then the selected counter coil turns ON at the next cycle. If the counted value change to a value less than "Preset ON" but still large than "Preset OFF", it still retains ON state. The counter coil does not turn OFF at next cycle until the counted value less than "Preset OFF". The counter will reset when the preceding rung is inactive. The table below describes each configuration parameter for High Speed Counter Mode 8.

Symbol	Description
①	High-speed counter mode 8
②	High-speed counter input: I01 or I02
③	Timing interval: 0-99.99 s
④	Preset value of Preset ON, range: 0-999999
⑤	Preset value of Preset OFF, range: 0-999999
⑥	Counter code (C01-C1F, 31 counters in total)

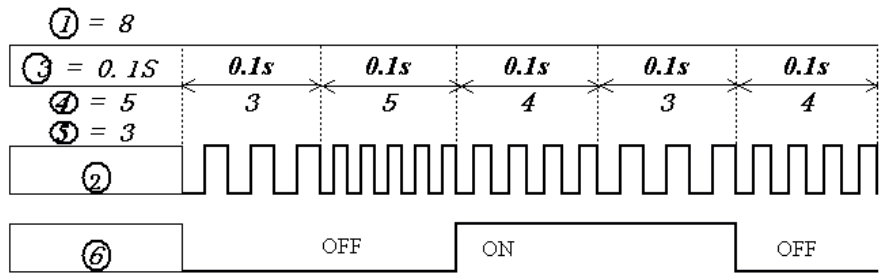
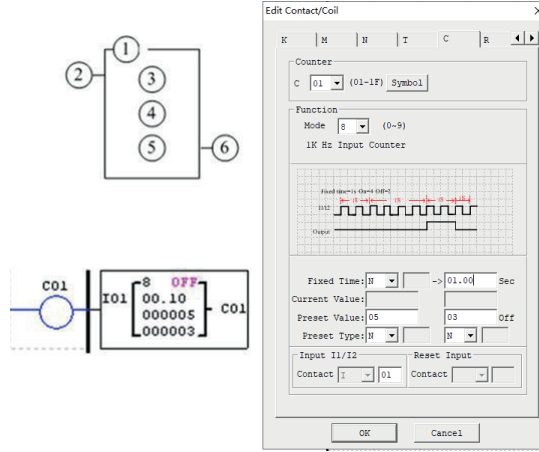

HIGH-SPEED COUNTER MODE 9 (1KHZ INPUT AB-PHASE COUNTER)

Mode 9 is AB-phase high-speed counting function for counting of two lines of pulse with consistent periodic pulse width and phase difference of 90°, which uses the same editing method with general high-speed counting function but has different parameters. The counter will reset when the preceding rung is inactive. The table below describes each configuration parameter for High Speed Counter Mode 8.

In DC machine, high-speed counter mode 9 enables high-speed input counting of the maximum 1KHz AB phases of I01 (A) ahead of I02 (B); the current value of counter is (0-999999), counting is stopped and output coil is ON when the counting value reaches the preset value; the current value of counter is reset to 0 and output coil is OFF after resetting.

Symbol	Description
①	High-speed counter mode 9
②	High-speed counter input, I01, I02
③	Reset coil ON: Current value of counter is reset to 0 OFF: Counter continues counting
④	Current value of counter: 0-999999
⑤	Preset value of counter 0-999999
⑥	Counter code (C01-C1F, 31 counters in total)

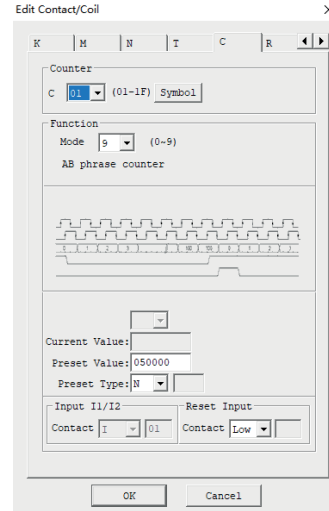
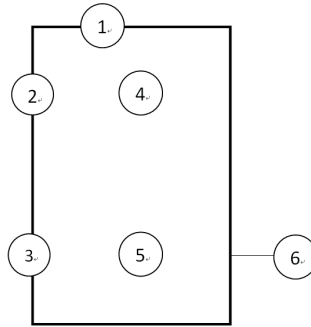

Coil M3A is the special coil, A/B is the counting direction flag . When Phase A leads phase B, M3A coil will be OFF, when phase B leads phase A, M3A will be ON;
When the current value overflows(The current value is greater than 999999);And next Phase A leads phase B The current value will be 0
When the current value overflows(The current value is less than 0);And next Phase B leads phase A, current value will be 999999;

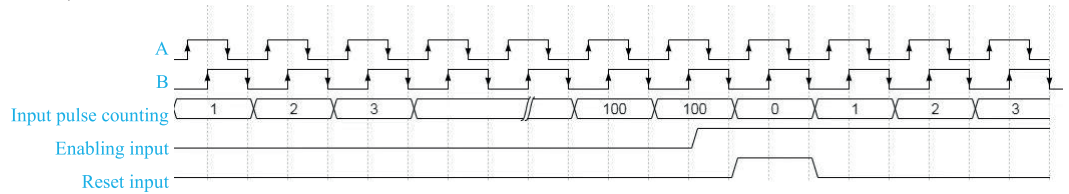

REAL-TIME CLOCK (RTC) INSTRUCTIONS

LRK includes 31 independent RTC functional blocks, and each block has 6 operating modes (mode 0~mode 5) and 6 parameters. Display of functional blocks and meaning of each parameter under Ladder are provided below.

Clock setting V3.0
2009.04.30
Thur 13:30

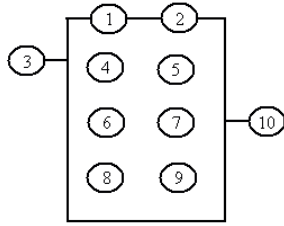

Symbol	Description
①	RTC input in the first week
②	RTC input in the second week
③	RTC mode 0~2: 0, internal coil mode; 1, day mode; 2, week mode
④	Current hour shown by RTC
⑤	Current minute shown by RTC
⑥	Set hour of RTC ON
⑦	Set minute of RTC ON
⑧	Set hour of RTC OFF
⑨	Set minute of RTC OFF
⑩	RTC code (R01~R1F, 31 RTCs in total)

RTC MODE 0 (INTERNAL COIL)

In RTC mode 0, coil R is used as internal coil and preset value is not required. In the following example, R01 is mode 0 and its status varies with the control condition I01.

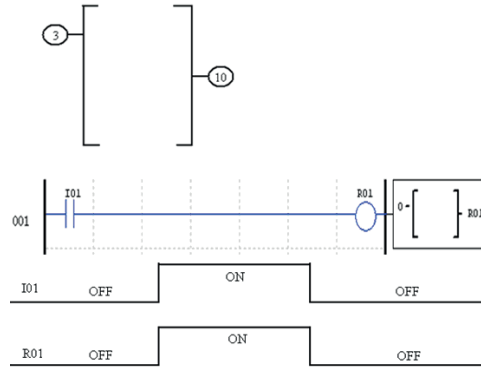

X

M | N | T | C | R | G | ◀ ▶

Real time clock

R 01 (01-1F) Symbol

Function

Mode 0 (0-5)

Internal Coil

Sa	Th	Wk	Th	Fr	Sa	Su

Enable:

Rx:

Week (On->Off): SU --> SU

Current Value: 10:07

Preset Value: 00 : 00 Sec 00 : 00 Sec (hour:minute)

OK Cancel

RTC MODE 1 (DAY MODE)

RTC mode 1 is for setting the daily ON/OFF time of each week.

In the following example (1), effective time of each week is set as MO (Monday) 8:00 to FR (Friday) 17:00, namely coil R01 outputs ON from 8:00 to 17:00 in Monday to Friday, and outputs OFF at other times.

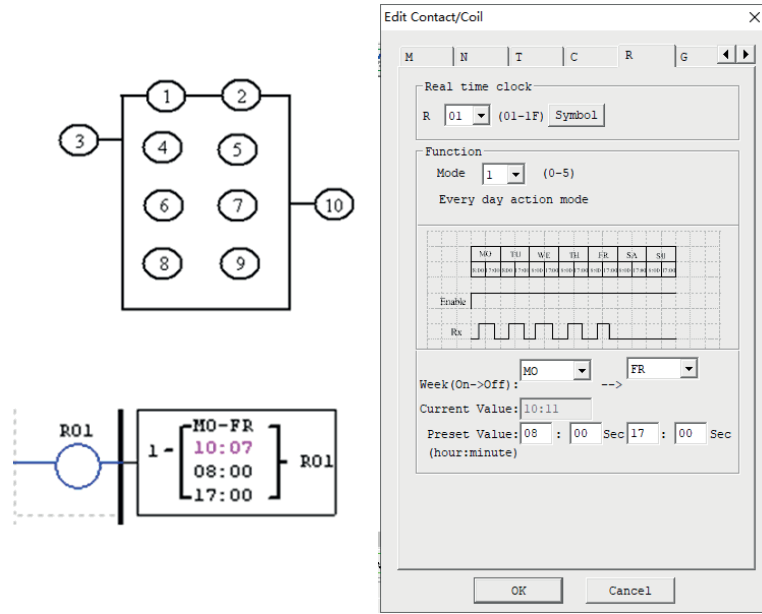

Example 1:

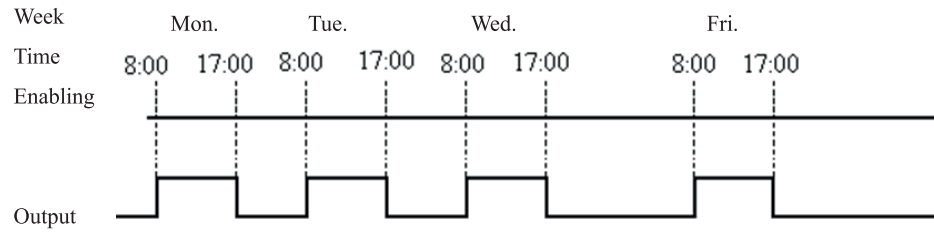

Example 2:

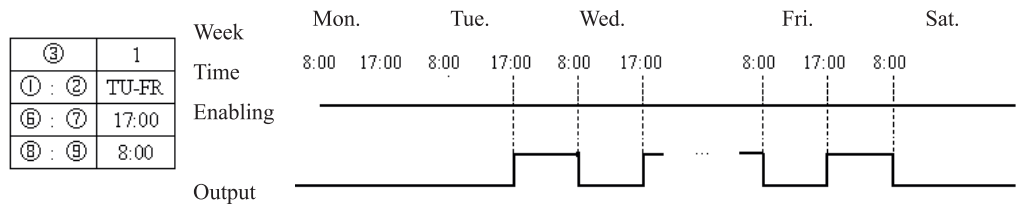

Example 3:

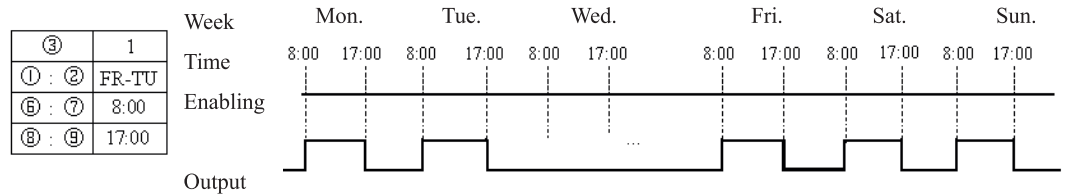

Example 4:

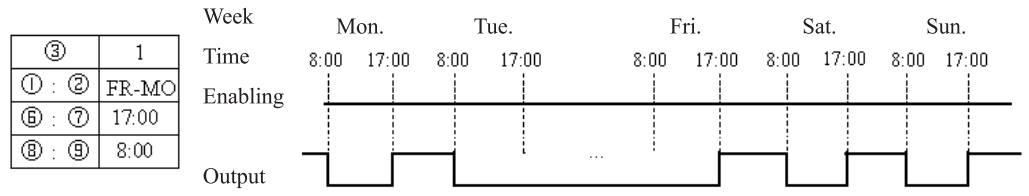

Example 5:

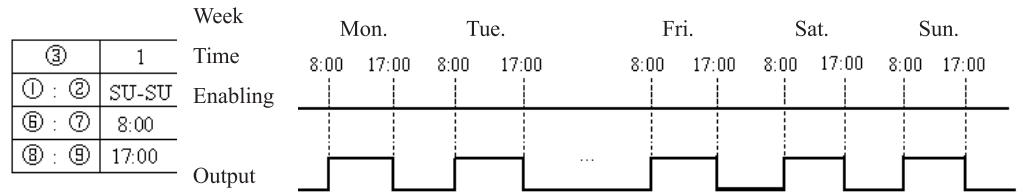

Example 6:

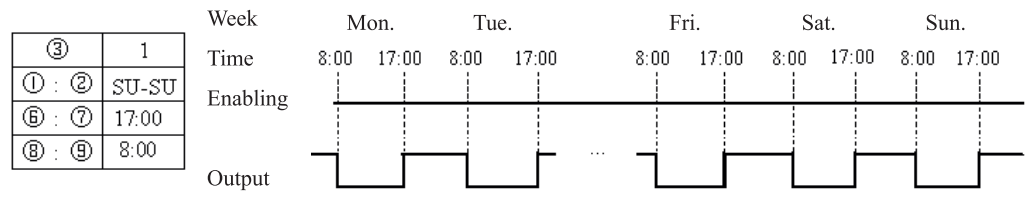

RTC MODE 2 (WEEK MODE)

RTC mode 2 is for setting ON/OFF time of coil R in a week. In the following example (1), coil R01 outputs ON from TU (Tuesday) 8:00 to SA (Saturday) 17:00, and outputs OFF at other times.

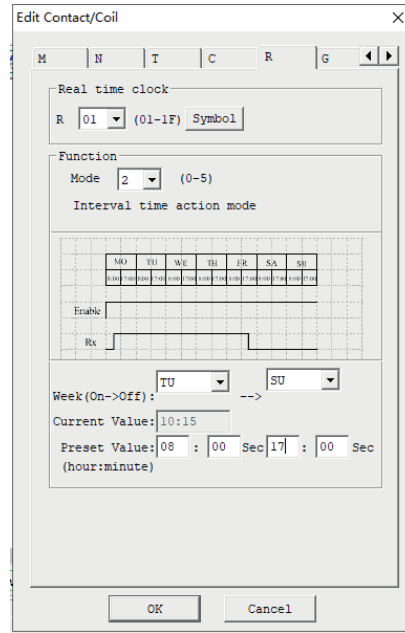
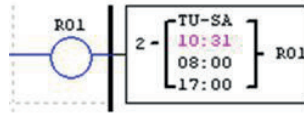
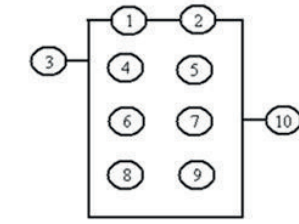

Example 1:

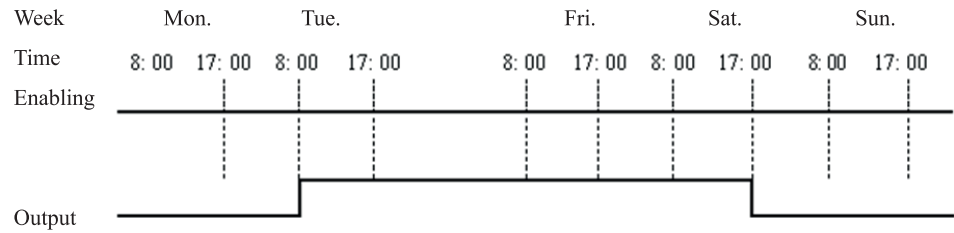

Example 2:

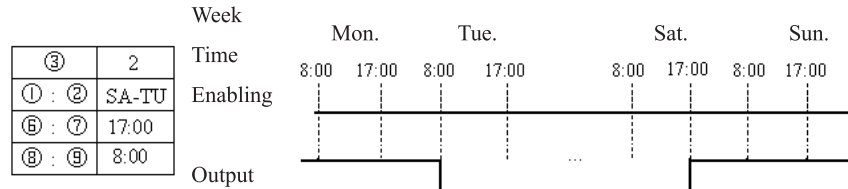

Example 3:

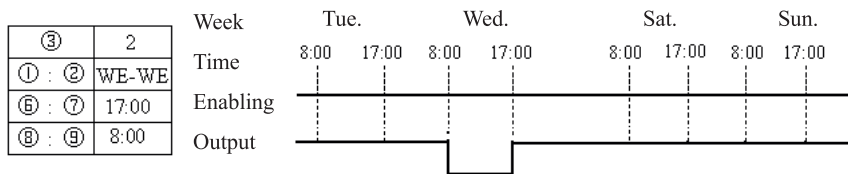

Example 4:

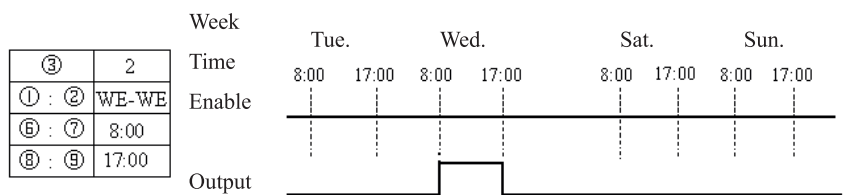

RTC MODE 3 (YEAR-MONTH-DAY MODE)

RTC mode 3 uses the set year-month-day to control status of coil R. The parameters of this mode and meanings of the parameters are provided below. In example 1, coil outputs ON from February 17, 2009 to November 11, 2010.

When the year setting is 00-00 in RTC mode3, a special mode is used to enable RTC from the beginning month and day to the end month and day of each year, as shown in example 4.

Symbol	Description
①	Set year of RTC ON
②	Set year of RTC OFF
③	RTC mode 3, year-month-day
④	RTC current time: year-month-day
⑤	Set month of RTC ON
⑥	Set day of RTC ON
⑦	Set month of RTC OFF
⑧	Set day of RTC OFF
⑨	RTC code (R01-R1F, 31 RTCs in total)

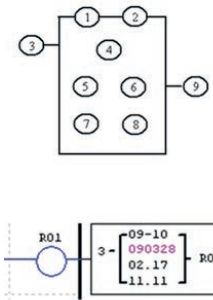
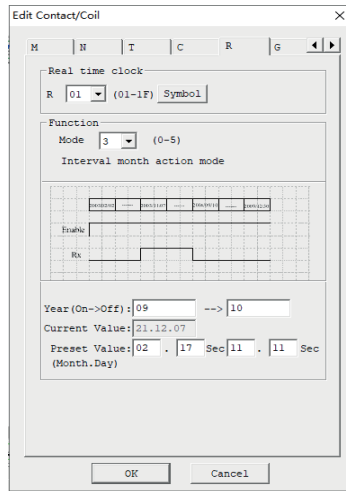

Example 1:

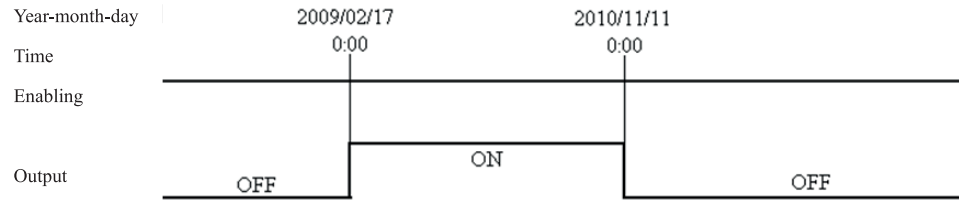

Example 2:

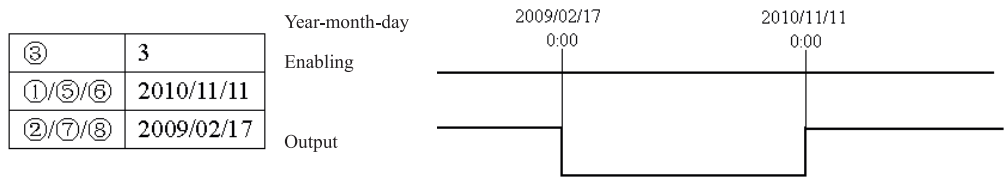

Example 3:

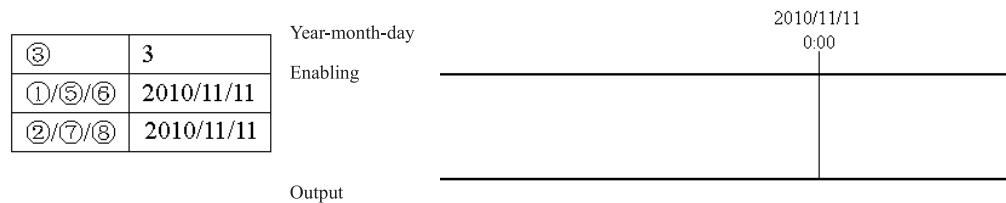

Example 4:

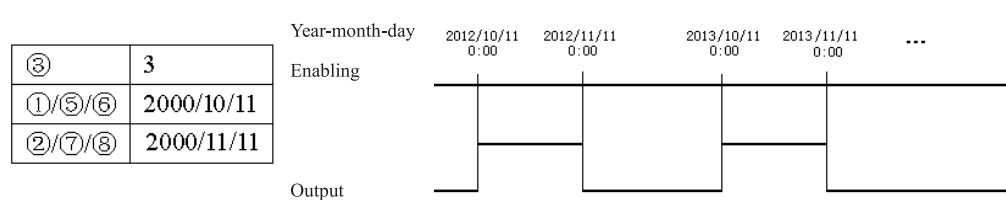

RTC MODE 4 (30S COMPENSATION)

RTC mode 4 is a 30s compensation mode, which uses the set week, hour, minute and second for operation of the current value of RTC and correction of RTC error. The display form and parameter meaning of RTC mode 4 and programming interface under Ladder are provided below.

Symbol	Description
①	Corrected week of RTC
②	RTC mode 4
③	Current hour of RTC
④	Current minute of RTC
⑤	Corrected hour of RTC
⑥	Corrected minute of RTC
⑦	Corrected second of RTC
⑧	RTC code (R01~R1F, 31 RTCs in total)

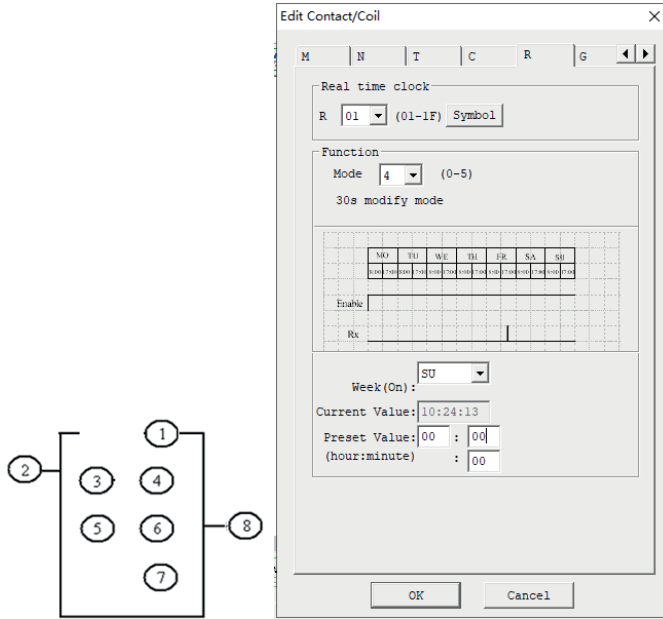

Example 1: Corrected second < 30s

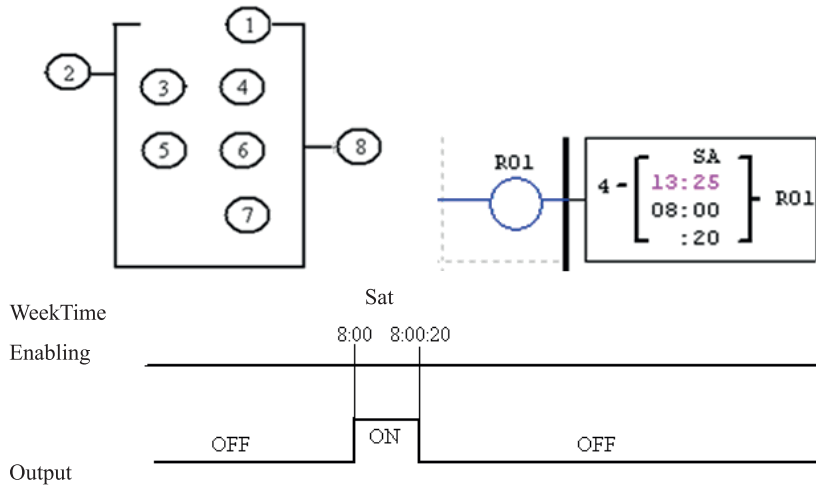

* When RTC time is 8:00:20, the current time returns to 8:00:00 for continuous timing, and coil outputs ON. When RTC time reaches 8:00:20 again, coil outputs OFF and RTC continues timing. So, the duration when coil outputs ON is 21s.

Example 2: Corrected second >= 30s

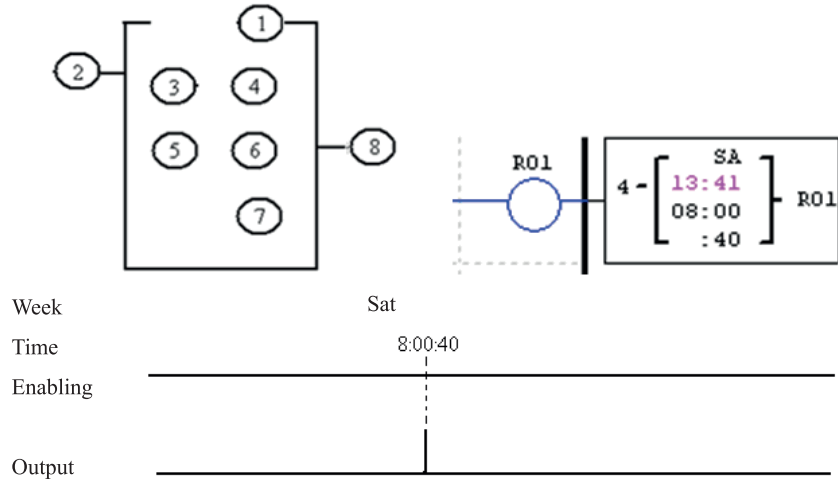

* R01 outputs ON when the current value of RTC is 8:00:40, and outputs OFF when RTC time changes to 8:01:00. The duration when output is ON is a scanning cycle only.

RTC MODE 5 (ASTRONOMICAL CLOCK)

RTC mode 5 is the astronomical clock mode that uses the set longitude and latitude and offset time to control output of RTC coil. The display form and parameter meaning of RTC mode 5 and programming interface under Ladder are provided in the following diagram and table.

Symbol	Description
①	RTC mode 5
②	RTC set longitude W/E
③	RTC set E/W longitude value
④	RTC set latitude S/N
⑤	RTC set S/N latitude value
⑥	RTC set offset +, -
⑦	RTC set offset value

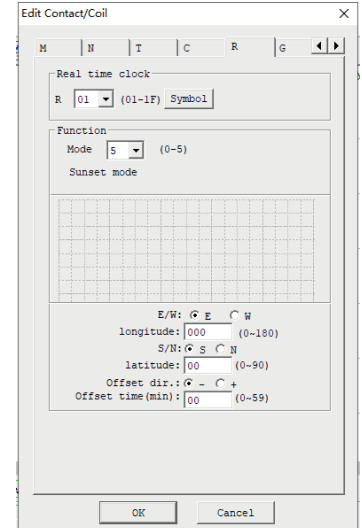
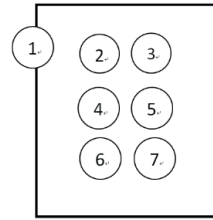

After the corresponding parameter, E/W (east/west longitude) and longitude value, S/N (south/north latitude) and latitude value are set as shown in the table above, the functional block R will work out the sunrise time and sunset time in the set place in the current season and enable the setting of forward (-) or backward (+) offset time (0~59min) of sunrise/sunset time by setting the offset direction, and coil R will output ON from sunrise to sunset and output OFF at other times.

Example 1: Set east longitude 130°, north latitude 30° and offset value +30min



* Sunrise/sunset time is computed based on the current value of RTC, and R01 is set ON from sunrise to sunset.

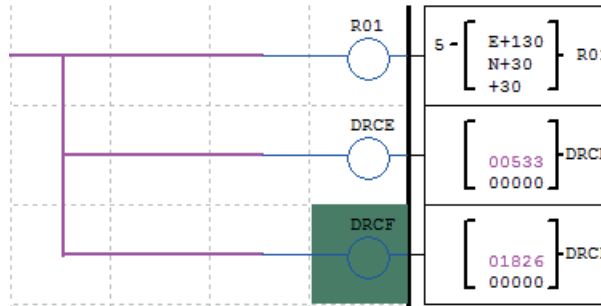

* DRCE and DRCF are special registers where longitude and latitude based sunrise, sunset and time (excluding offset) are stored.

ANALOG COMPARATOR INSTRUCTIONS

LRK includes 31 independent comparator instructions, and each comparator has 8 working modes and 5 functional parameters. The display diagram and parameters of the comparator are provided below.

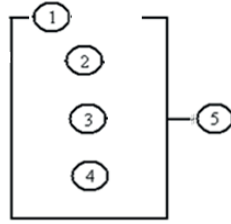

Symbol	Description
①	Comparator mode (0-7)
②	Ax analog input (0.00-99.99)
③	Ay analog input (0.00-99.99)
④	Comparator reference value
⑤	Comparator code (G01~G1F)

* The preset value of analog inputs Ax and Ay and comparator reference value may be a constant or code of other data type.

COMPARATOR MODE 0 (INTERNAL COIL)

Mode 0 Comparator (Internal Coil), used as internal auxiliary coils. No preset value. In the example below shows the relationship among the numbered block diagram for a Mode 0 Comparator, the ladder diagram view, and the software Edit Contact/Coil dialog box.

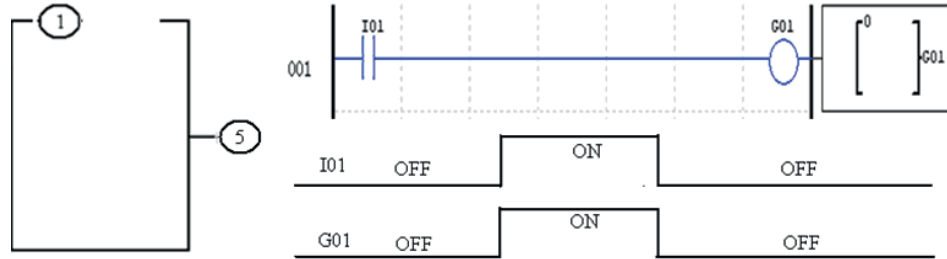

Comparator mode 1-7

- (1) Comparator mode 1: $Ay - ④ \leq Ax \leq Ay + ④$, ⑤ ON ;
- (2) Comparator mode 2: $Ax \leq Ay$, ⑤ ON ;
- (3) Comparator mode 3: $Ax \geq Ay$, ⑤ ON ;
- (4) Comparator mode 4: $④ \geq Ax$, ⑤ ON ;
- (5) Comparator mode 5: $④ \leq Ax$, ⑤ ON ;
- (6) Comparator mode 6: $④ = Ax$, ⑤ ON ;
- (7) Comparator mode 7: $④ \neq Ax$, ⑤ ON

Example 1: The comparator works in mode 4, and G01 outputs ON when comparator reference value 2.50V is higher than or equal to Ax analog input A01, or outputs OFF otherwise.

Example 2: The comparator works in mode 5, and G01 outputs ON when comparator reference value T01 is lower than or equal to Ax analog input C01, or outputs OFF otherwise.

The diagram illustrates a comparator circuit and its configuration. On the left, a vertical stack of four terminals (1, 2, 3, 4) is connected to a single output terminal (5). Below this, a coil symbol labeled G01 is connected to a contact symbol. The contact symbol is a rectangle containing a '5' at the top, 'C01' in the middle, and 'T01' at the bottom, with 'G01' on the right side. To the right is the 'Edit Contact/Coil' dialog box. It features a menu bar with 'N', 'I', 'C', 'R', 'G', and 'F'. The 'Active on/off edge' section has a dropdown set to '01' and a 'Symbol' button. The 'Function' section has a 'Mode' dropdown set to '5' and the text 'Ax>=Ref.'. Below this is a grid. The 'Ax' and 'Ay' sections have dropdowns set to 'C' and '01' respectively. The 'Current Value' field is empty, with 'Sec' labels. The 'preset value' is '00.00' and the 'Ref' field is empty. The 'Preset Type' dropdown is set to 'I' and the '01' field is empty. 'OK' and 'Cancel' buttons are at the bottom.

FILTER INSTRUCTIONS

LRK includes 31 independent Filter instructions, and each filter has 5 working modes. The display diagram and parameters of filter are provided below.

FILTER MODE 0 (INTERNAL COIL)

Mode 0 Filter (Internal Coil) used as internal auxiliary coils. No preset value. In the example below shows the relationship among the numbered block diagram for a Mode 0 Filter, the ladder diagram view, and the software Edit Contact/Coil dialog box.

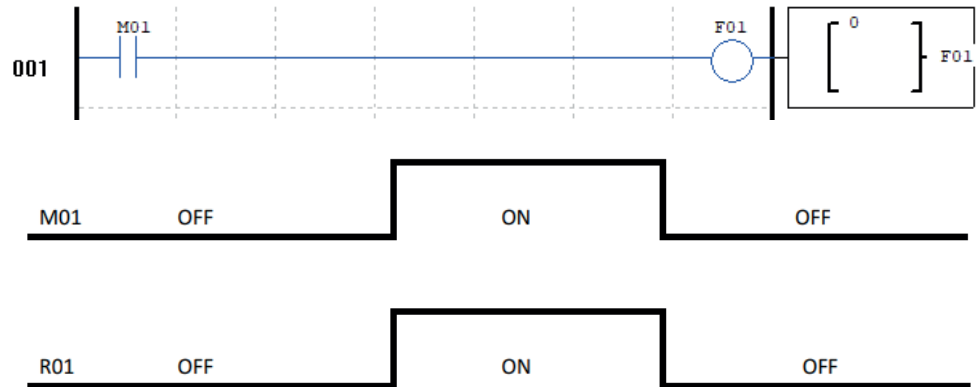

FILTER MODE 1: ANALOG FILTER

Function description: Analog filter function is started after parameters are configured and status of the enabled coil turns from 0 to 1. This function enables filtering of Ax analog value based on the selected sampling mode, and the filtered value is the current value of coil F. Output: The analog value of input Ax is calculated based on the current number of samples Sn.

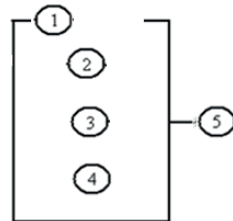

Symbol	Description
①	F mode selection
②	Ax analog input
③	Current value
④	Sampling mode
⑤	Filter code (F01~F1F)

Software filter mode:

(Mode 1): Data is updated in each scanning cycle, and the recent 5 AD values (maximum and minimum values removed) is averaged.

(Mode 2): Data is updated every 5 scanning cycles. The average values of mode 1 are further averaged after statistics for 5 times.

(Mode 3): Data is updated every 25 scanning cycles. The maximum and minimum averages of the values obtained in mode 2 are used after statistics for 5 times.

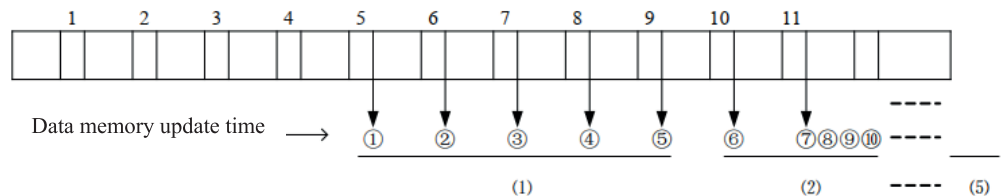

Example: Data 1=161, data 2=120, data 3=154, data 4=160, data 5=190, data 6=169, data 7=110, data 8=121, data 9=150, data 10=198, data 11=199.

Mode 1:

① Updated data=(161 + 154 + 160) / 3=158-filter (1, 2, 3, 4, 5)

Maximum value 190 and minimum value 120 will be deleted.

② Updated data =(154 + 160 + 169) / 3=161- filter (2, 3, 4, 5, 6)

Maximum value 190 and minimum value 120 will be deleted.

③ Updated data =(154 + 160 + 169) / 3=161- filter (3, 4, 5, 6, 7) Maximum value 190 and minimum value 110 will be deleted.

::

⑦ Updated data =(121 + 150 + 198) / 3=156- filter (7, 8, 9, 10, 11) Maximum value 199 and minimum value 110 will be deleted.

Mode 2:

The 5 data values of mode 1 are averaged.

$(①+②+③+④+⑤) / 5$

Mode 3:

Among the 5 data values obtained after 5 operations of mode 2, the maximum value and minimum value are taken, and then the two values are averaged.

This mode is effective in filtering ripple or ripple noise.

(Maximum value + minimum value) / 2 (wherein, the maximum and minimum value range is(1)(2)(3)(4)(5)).

FILTER MODE 2: AVERAGE VALUE

Function description: The enabling coil is set ON to enable the average function, which is used to calculate the average value of analog inputs in the set time period.

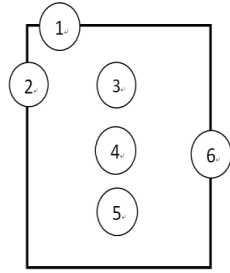

Symbol	Description
①	F mode
②	Time base
③	Current value of F
④	Analog input Ax
⑤	Sampling time
⑥	Filter code (F01~F1F)

Timing diagram (for example)

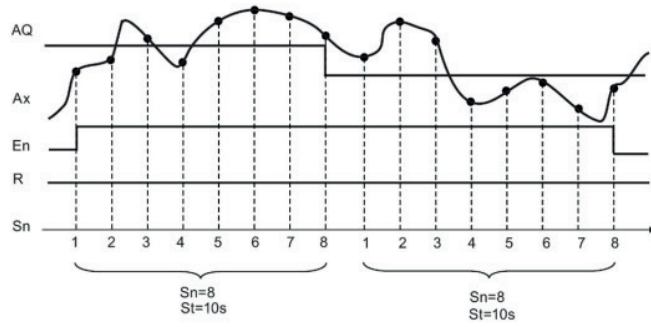

Example: As shown above, the current value of F is updated every 10s, and coil F01 is set ON each time when the current value is updated.

FILTER MODE 3: MAXIMUM VALUE

The maximum value function is enabled and status of output coil and enabling coil is consistent after the enabling coil is set ON, and the function is disabled and status of output coil and enabling coil is consistent after the enabling coil is set OFF. While the enabling coil is ON, the current value of block F is recorded as the maximum value of analog input Ax.

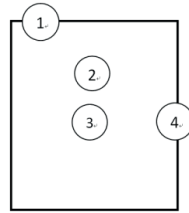

Symbol	Description
①	Comparator mode
②	Current value
③	Ax analog input
④	Filter code (F01-F1F)



FILTER MODE 4: MINIMUM VALUE

The minimum value function is enabled and status of output coil and enabling coil is consistent after the enabling coil is set ON, and the function is disabled and status of output coil and enabling coil is consistent after the enabling coil is set OFF. While the enabling coil is ON, the current value of block F is recorded as the minimum value of analog input Ax.

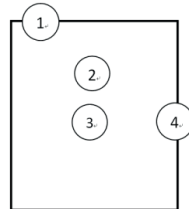

Symbol	Description
①	Comparator mode
②	Current value
③	Ax analog input
④	Filter code (F01-F1F)



HMI INSTRUCTIONS

LRK includes 31 independent HMI instructions, and each HMI instruction enables display of content in 16x4 characters on LCD in the form of text, figure, coil status, preset value and current value of functional block. Text displayed by HMI has three types: multi-language (as shown to the right), built-in Chinese and user-defined Chinese. Each HMI instruction must be edited by LRK software. Select the menu "Edit -> HMI/TEXT", and the HMI editing interface as shown to the right will pop up. While HMI instructions are not enabled, press SEL on I/O interface, when HMI of the lowest coded value will appear on LCD.

Allows the SEL button on the LRK keypad to activate the selected message onto the LCD even the Hxx is inactive.

* Refer to Chapter III: Programming Tool-Ladder Programming Environment-HMI/TEXT for editing and use methods of HMI function.

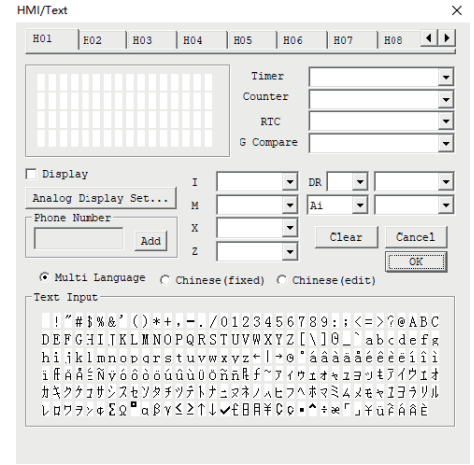

Each HMI has 2 working modes and 2 parameters. The meaning and display form of the parameters are provided below.

Symbol	Description
①	HMI mode (1~2)
②	HMI code (H01~H1F)

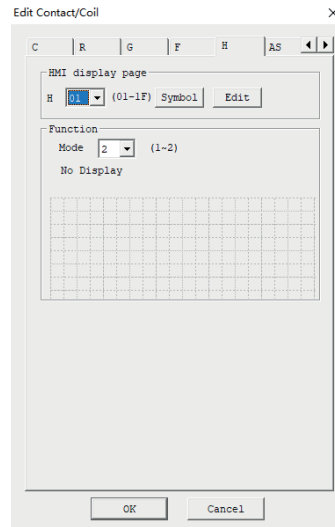

HMI DISPLAY DESCRIPTION

- HMI enables display of characters, built-in Chinese character and phone number which cannot be modified by keypad.
- HMI enables display of the preset value and current value of functional blocks (T, C, R, G, DR) and analog input and output (A, AT, AQ), among which, preset value can be modified by keypad.
- HMI enables display of status of coils (I, X, Z, M and N), which may be modified by keypad.
- When display is enabled by multiple HMIs, keypad can be used to for scrolling display of any enabled HMI.
- When a new HMI is enabled, it will be displayed if the current HMI number displayed is lower than the new HMI number; otherwise, the original display is kept.

Key description

SEL	Enter status 3 from status 1 or 2 Enter status 4 from status 3 Change the type of preset value of functional block under status 4
↑ or ↓	Find the close HMI of mode 1 under status 1 Find the close HMI enabled under status 2 Move the cursor upward or downward under status 3 Change data or coil status under status 4
(SEL+ ↑ or ↓)	Find the close HMI of mode 1 under status 1 Find the close HMI enabled under status 2 Move the cursor upward or downward under status 3
← or →	Move the cursor to the left or right under status 3 or 4
OK	Confirm and save the editing
ESC	Exit

DESCRIPTION OF HMI STATUS 1-4

- HMI scanning status: Press SEL on the I/O interface.



- HMI running status: Enable HMI on the I/O interface.

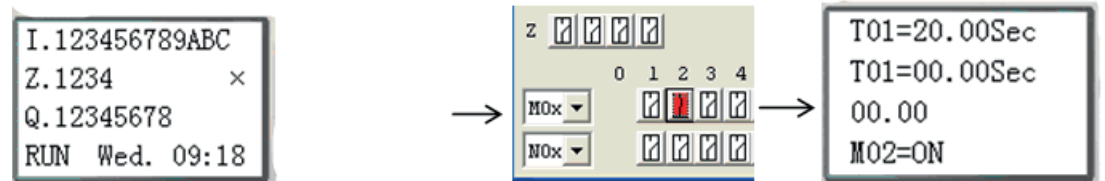

- HMI editing ready status: Press SEL under scanning or running status of HMI; if the current HMI displayed has editable content, the cursor will blink on the content.



- HMI editing status: Press SEL under the editing ready status, and blinking cursor will change to underline.



IO LINK/REMOTE IO INSTRUCTIONS (FOR LRD20RD024RS TYPE ONLY)

LRD20RD024RS has built-in RS 485 communication port. It can be used as master/slave station of ModBus RTU, or connected with other LRD20RD024RS to form IO Link or remote IO. The communication mode and baud rate can be set through Operation(O)»Module system setting(Y) of LRXSW programming software or keypad.

The keypad setting is shown to the right, and meaning of the two bits in RS485 setting is explained in the following table.

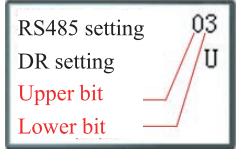

	Code	Meaning
Upper bit	0	8/N/2: 8 data bits without check, 2 stop bits
	1	8/E/1: 8 data bits with even parity check, 1 stop bit
	2	8/O/1: 8 data bits with odd parity check, 1 stop bit
	3	8/N/1: 8 data bits without check, 1 stop bit
Lower bit	0	4800bps
	1	9600bps
	2	19200bps
	3	38400bps
	4	57600bps
	5	115200bps

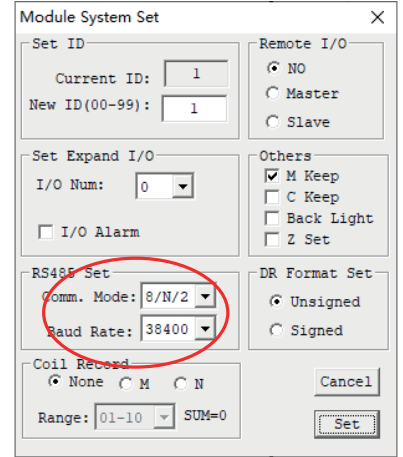

IO LINK

An IO Link is composed of 8 micro-plc type LRD20RD024RS type at most, where each slave contact is used as an independent station for running of its logic program and all slave contacts are connected to the same master station. IO Link ID must be continuous and be 0-7; master station ID is 0, and slave station ID begins from 1 to 7; if slave station ID is not continuous, such as 1, 2, 4, 5, the master station will take it as there are only two slave stations 1 and 2 and communicate with slave stations 1 and 2 only.

- max. 8 points I/O send per stations
- Max 7*8 (=56) points I/O received per station

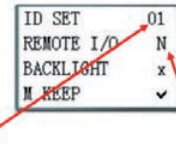

ID must set to be 0,1,2,...(max to 7) **Remote I/O disable**

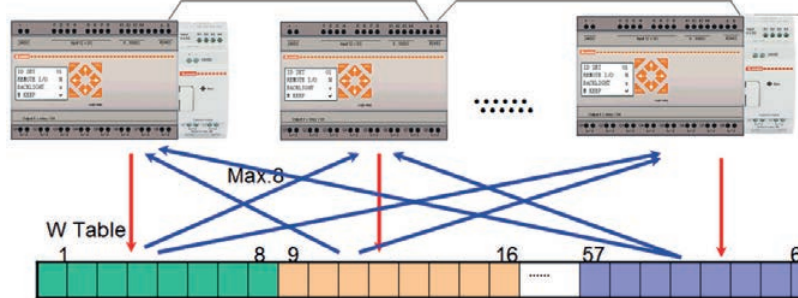

ID	W table comparison
0	W01-W08
1	W09-W16
2	W17-W24
3	W25-W32
4	W33-W40
5	W41-W48
6	W49-W56
7	W57-W64

* When each station uses L01~L08, only one can be set as mode 1: sending mode, and the other L can only be set as mode 2: receiving mode. Sending mode: Address in W table is controlled by ID of LRK itself and cannot be changed, and status of the selected coil is put in the corresponding W table. The correspondence of ID and W table is shown in the above table. Receiving mode: content of the selected W table is transferred to the selected coil; if input coil I or X is selected, content of W table will not change status of coils I and X.

Symbol	Description
①	IO Link mode, 1: sending, 2: receiving
②	Sending/receiving points (1~8)
③	Sending/receiving coil type
④	Position of sent/received data in W table
⑤	I/O Link code (L01~L08)

Coil type	Number
Input coil	I01~I0C/i01~i0C
Output coil	Q01~Q08/q01~q08
Auxiliary coil	M01~M3F/m01~m3F
Auxiliary coil	N01~N3F/n01~n3F
Extended input	X01~X0C/x01~x0C
Extended output	Y01~Y0C/y01~y0C

In the following example, L01 works in mode 1; it can be concluded from position of W table that the machine ID is 1 and it is a slave station.

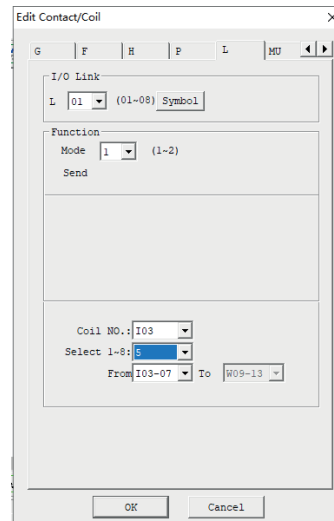
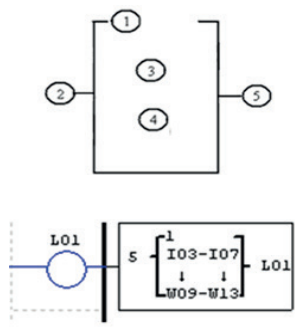

Example 1: Sending mode

The set mode is 1, coil number is 5, starting coil is I03 and LRK ID is 1, status of coil I03-I07 will be sent to W09-W13, as shown below.

① =1, ② = 5, ③ = I03~I07, ID=1 (④:W09~W13)								
W table position	W09	W10	W11	W12	W13	W14	W15	W16
Receiving or sending coil	↑	↑	↑	↑	↑	↑	↑	↑
	I03	I04	I05	I06	I07	0	0	0

Example 2: Receiving mode

The set ① = 2 mode is 2, coil number is 5, starting coil is M03, W table position is W17 and not controlled by ID, content of W17-W21 will be sent to coil M03-M07.

① =1, ② = 5, ③ = M03~M07, ④:W17~W21					
W table position	W17	W18	W19	W20	W21
Receiving or sending coil	↓	↓	↓	↓	↓
	M03	M04	M05	M06	M07

Remote IO

A remote IO network is composed of two LRK20RD024RS at most, where one is the master station and the other is the slave station. The setting method and IO correspondence are as follows.

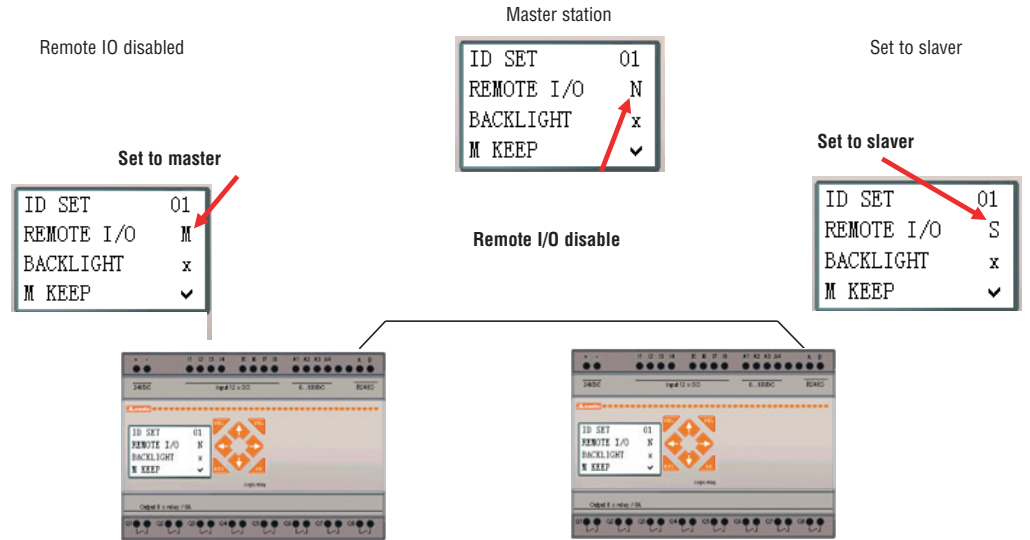

Master station
 Valid user program
 Extended input X = slave station input I
 Extended output Y = slave station

Slave station
 Invalid user program
 Input I = master station extended input X
 Output Q = master station extended output

Valid user program
 X = slave station input
 Y = slave station output

Invalid user program
 X = master station extended input
 Y = master station extended output

Logic program runs in the master station, but not in slave station. The master station writes extended output Y to slave station Q, and slave station writes input I to master station extended input X.

* Extended IO module should not be used when the remote IO function is used.

MU (MODBUS) INSTRUCTIONS (FOR LRD20RD024RS TYPE ONLY)

The Modbus block of LRD20RD024RS realizes Modbus RTU master communication at RS485 interface. LRD20RD024RS includes 15 Modbus blocks, MU01~MU0F. RS485 type communication gives priority to Remote IO and IO Link, namely the functional block is not executed by Remote IO master and slave and IO Link master, and Modbus instruction is executed only when it is set as N (remote IO) and ID is not 0.

Multiple communication instructions may be used in a program, but only one instruction can be driven at the same time. For example, when multiple Modbus instructions are used and enabled, only one instruction utilizes serial port for execution of its function, while the other Modbus instructions keep the enabled state but do not execute function, namely the other instructions enter the execution waiting state. When the Modbus instruction utilizing serial port is disabled and releases the serial port after the end of an instruction cycle, the other enabled Modbus instructions begin to preempt the serial port.

ID SET	01
REMOTE I/O	N
BACKLIGHT	x
M KEEP	✓

Comparison table of Modbus mode and communication function code:

Mode	Function code
1	03 (read register)
2	06 (write a single register)
3	10 (write various registers)
4	01 (read coils)
5	05 (write a single coil)

Auxiliary contacts used during execution of Modbus instructions:

Mode	Function code
Receiving completed M3D	After completion of receiving, M3D is set for error checking, and the received data is sent to the designated register if no error is found;
Error indication M3E	Communication error indication
Timeout judgment M3F	Enter the receiving waiting state after completion of sending; when timeout is determined as no data is received within the specified time period, the timeout output flag M3F is ON, receiving is ended and M3D outputs ON; M3F is automatically reset at the time of M3D resetting.

Timeout judgment and time-out period are determined by baud rate.

Baud rate (bps)	Timeout (ms)
4800, 9600, 19200, 38400	125
57600	100
115200	80

Modbus block has 5 parameters, the display and meaning of which are listed below.

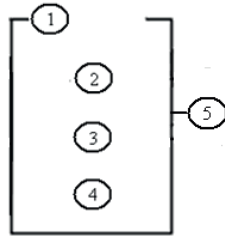

Symbol	Description
①	MU block mode 1-5
②	Communication address: Slave station ID, range 0-7f
③	Communication command address and communication data length: 1) Constant, range 0000-ffff; Data length of modes 1 and 3 is 1 word; Data length of mode 4 is 16 bits; 2) DR number, command address and length being stored from the DR
④	DR number, data sent/received being stored from the DR
⑤	MU code (MU01~MU0F)

* The maximum communication data length of modes 1 and 3 is 25 words, and that of mode 4 is 400 bits.

MU display and editing interface are shown below:

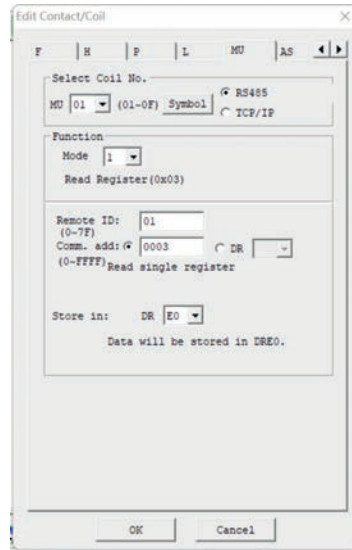
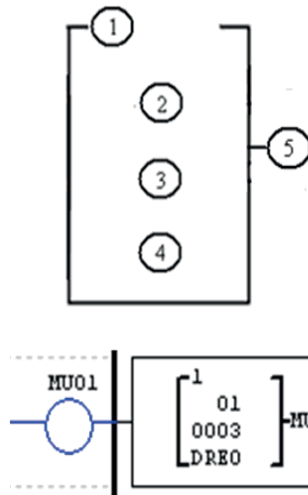

Given command address constant 0003 and data length 1 word
The sending command is:
01 03 00 03 00 01 CRC16

Receiving response data of slave station 1:
01 03 02 data1 data2 CRC16
Data stored in DRE0:
DRE0 = data1-2

MU MODE 1: READ REGISTER

Set communication address of parameter ③ as a constant: As shown above, communication data length is 1.

Set communication address of parameter ③ as register DR:

Edit Contact/Coil
 F H P L MU AS
 Select Coil No.
 MU 01 (01-0F) Symbol RS485 TCP/IP
 Function
 Mode 1
 Read Register(0x03)
 Remote ID: 01 (0-7F)
 Comm. addr: DR 03 (0-FFFF)
Starting add. depends on DR03 value. Amount of read register depends on DR04 value, max is 25
 Store in: DR E0
Data will be stored in registers sequentially starting from DRE0.
 OK Cancel

Functional block parameters are displayed as below:



Set command address DR03=0001

Set data length DR04=0002

The sending command is:

01 03 00 01 00 02 CRC16

Receiving response data of slave station 1:

01 03 04 data1 data2 data3 data4 CRC16

Data stored in DRE0~DRE1:

DRE0 = data1~2 DRE1 = data3~4

* The maximum value of data length register is 25.

MU MODE 2: WRITE A SINGLE REGISTER

Set communication address of parameter ③ as a constant:

Functional block parameters are displayed as below:



Command address constant 0003
 Set numerical data DRE0=1234 (hex: 04D2)
 The sending command is:
 01 06 00 03 04 D2 CRC16

Receiving response data of slave station 1:
 01 06 00 03 04 D2 CRC16

Set communication address of parameter ③ as register DR:

Functional block parameters are displayed as below:

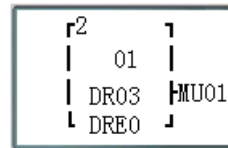

Set command address DR03=0001
 Set data DRE0=1234 (hex: 04D2),
 The sending command is:
 01 06 00 01 04 D2 CRC16

Receiving response data of slave station 1:
 01 06 00 01 04 D2 CRC16

MU MODE 3: WRITE VARIOUS REGISTERS

Set communication address of parameter ③ as a constant:

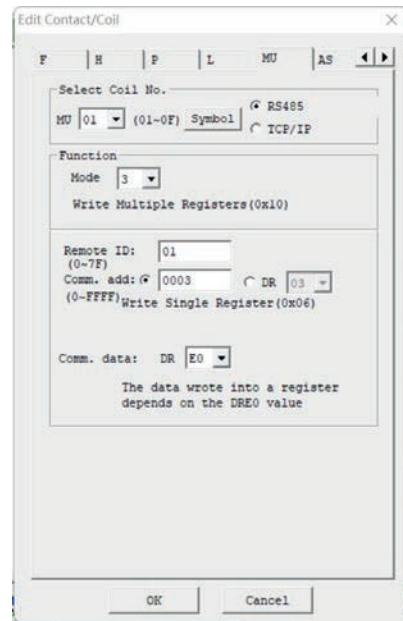

Functional block parameters are displayed as below:

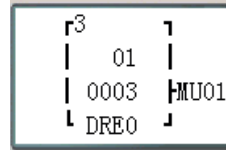

Command address constant 0003
Data length is 1 word
Set data DRE0=1234 (hex: 04D2),
The sending command is:
01 10 00 03 00 01 02 04 D2 CRC16

Receiving response data of slave station 1:
01 10 00 03 00 01 CRC16

Set communication address of parameter ③ as register DR:

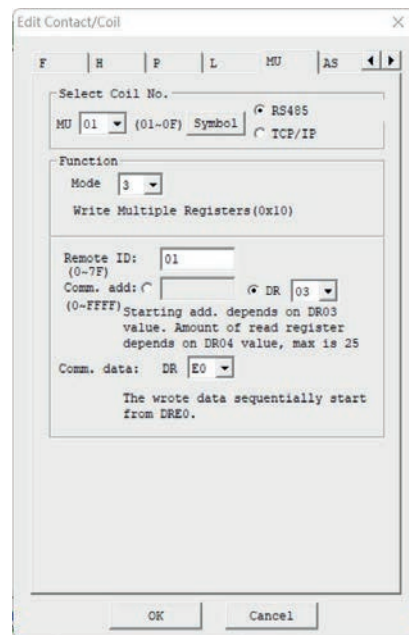

Functional block parameters are displayed as below:



Set command address DR03=0001
Set data length DR04=0002,
Set data DRE0=1234 (hex: 04D2)
Set data DRE1=5678 (hex: 162E)
The sending command is:
01 10 00 01 00 02 04 04 D2 16 2E CRC16

Receiving response data of slave station 1:
01 10 00 01 00 02 CRC16

* The maximum value of data length register is 25.

MU MODE 4: READ COIL

Set communication address of parameter ③ as a constant:

Functional block parameters are displayed as below:

```

┌4      ┐
│  01  │
│ 0020 │MU01
└DRE0  ┘

```

Command address constant 32 (hex: 0020),
Data length is 16 (hex: 10H, 1word),
The sending command is:
01 01 00 20 00 10 CRC16

Receiving response data of slave station 1:
01 01 02 data1 data2 CRC16;
Data stored in DRE0:
DRE0 = data1~2

Set communication address of parameter ③ as register DR:

Functional block parameters are displayed as below:

```

┌4      ┐
│  01  │
│ DR03 │MU01
└DRE0  ┘

```

Set command address DR03=0001,
Set data length DR04=0015 (hex: 000F);
The sending command is:
01 01 00 01 00 0F CRC16

Receiving response data of slave station 1:
01 01 02 data1 data2 CRC16;
Data stored in DRE0:
DRE0 = data1~2

* The maximum value of data length register is 400.

MU MODE 5: WRITE A SINGLE COIL

Set communication address of parameter ③ as a constant:

Functional block parameters are displayed as below:

5	1
01	MU01
0003	
DRE0	

Command address constant 0003,
Set data DRE0=65280 (hex: FF00), T
he sending command is:
01 05 00 03 FF 00 CRC16.

Receiving response data of slave station 1:
01 05 00 03 FF 00 CRC16.

Set communication address of parameter ③ as register DR:

Functional block parameters are displayed as below:

5	1
01	MU01
DR03	
DRE0	

Set command address DR03=0001,
Set data DRE0=65280 (hex: FF00),
The sending command is:
01 05 00 01 FF 00 CRC16

Receiving response data of slave station 1:
01 05 00 01 FF 00 CRC16

Example:

Data is sent and received through RS485 port after MU is enabled. It is suggested to use communication of D trigger control MU instruction.

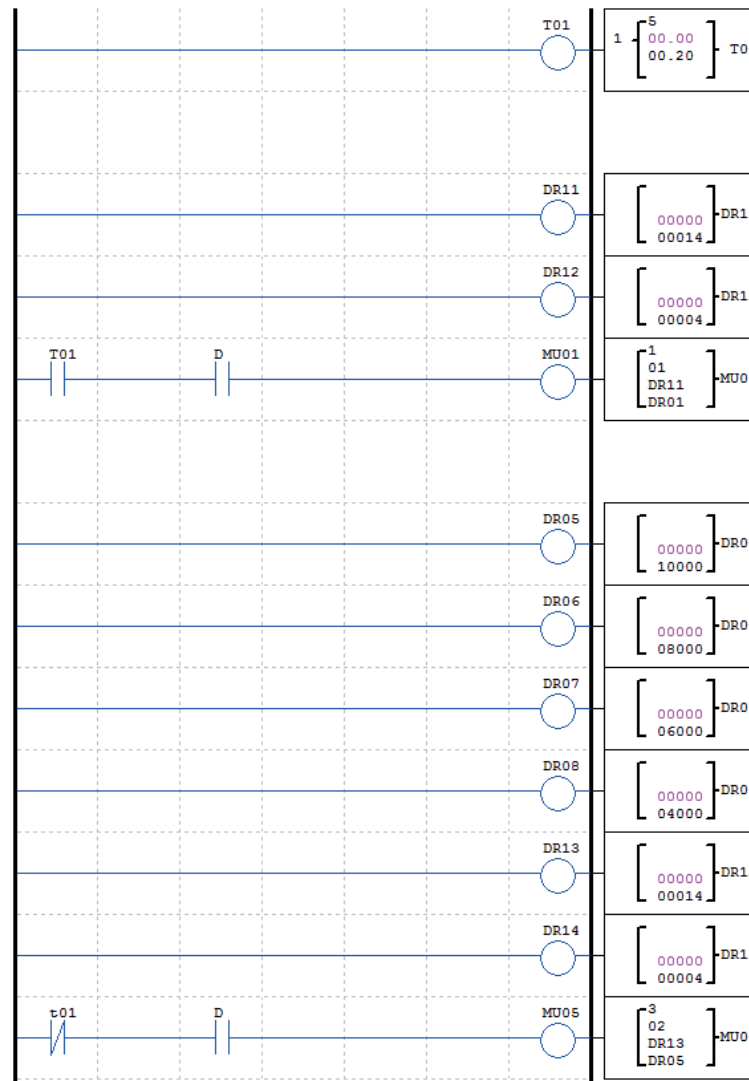

T01 controls MU01 and MU05;

Set MU01 mode 1, read register, address is DR11=14 (0x0E), length is DR12=4, save to register DR01-DR04;

Set MU05 mode 3, write register, address is DR13=14 (0x0E), length is DR14=4, data is fetched from register DR05-DR08 (DR05=10000=0x2710, DR06=8000=0x1F40, DR07=6000=0x1770, DR08=4000=0x0FA0);

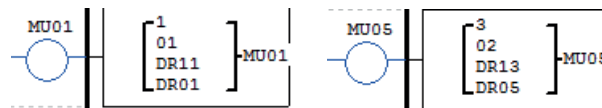

During running, T01 is ON, a MU01 communication is triggered, command 01 03 00 0E 00 04 CRC16 is sent, data is stored in DR01-DR04 after response is received from slave station 1; 0.2s later, T01 is OFF, MU05 communication is triggered, command 01 10 00 0E 00 04 08 27 10 1F 40 17 70 0F A0 CRC16 is sent; 0.2s later, T01 ON triggers MU01, and 0.2s later, T01 OFF triggers MU05.....cycling in order.

SHIFT INSTRUCTIONS

LRK includes 1 SHIFT instruction, which is for cycling and alternating output of effective status at the specified contacts. SHIFT instruction has 4 parameters, the display and meaning of which are listed below.

Symbol	Description
①	Number of output contacts (1-8)
②	SHIFT input contact (I01-g1F)
③	SHIFT output contact (Q, Y, M, N)
④	SHIFT code (S01)

In the following example, the number of output contacts is 5, input contact is I01, output contact is Q03-Q07, and output timing is shown below.

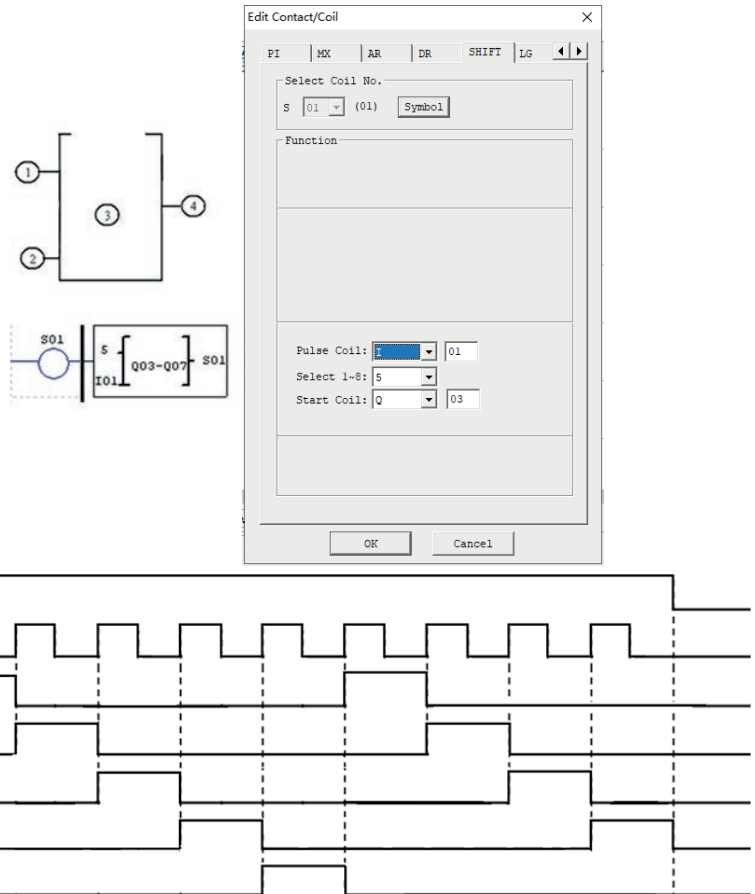

* After SHIFT is enabled, the first contact Q03 outputs ON, and the rising edge of I01 resets the previous contact and effects the next contact, and so forth, till SHIFT is disabled and all contacts are reset.

AQ ANALOG OUTPUT INSTRUCTIONS

AQ analog output instructions are used with the extended analog output module 2AO.

The default output mode of AQ is voltage mode 0~10V, where 12bits value is 0~4095 and the corresponding AQ value is 0~1000.

When the output mode is set as current mode 0~20 mA, 12bits value is 0~2047 and the corresponding AQ value is 0~500.

12bits value of AQ is stored in register DRD4~DRD7, and output mode is based on the current value of register DRD0~DRD3, as listed below.

Mode	Output register	Mode register	Mode	DRD0~DRD3 data definition
Channel 1: AQ01	DRD4	DRD0	1	0: voltage mode, AQ output value 0 in STOP mode
Channel 2: AQ02	DRD5	DRD1	2	1: current mode, AQ output value 0 in STOP mode
Channel 3: AQ03	DRD6	DRD2	3	2: voltage mode, AQ output value kept in STOP mode
Channel 4: AQ04	DRD7	DRD3	4	3: current mode, AQ output value kept in STOP mode

* DRD0~DRD3 value is taken as 0 when it is not 0~3, namely AQ output mode is mode 1.

* 2AO connected to the near-end of master corresponds to output AQ01 and AQ02, and that to the far-end corresponds to output AQ03 and AQ04.

* Refer to Chapter VIII: Extended Module Instructions-Extended Analog Modules for use of analog output modules.

AQ DISPLAY

* AQ displays the preset value (constant or code of other data type) in STOP mode, or the current value in RUN mode.

Display in STOP mode

```
AQ01=09.77V
AQ02=20.00mA
AQ03= A01 V
AQ04=DR3F mA
```

Display in RUN mode

```
AQ01=09.77V
AQ02=20.00mA
AQ03=02.10V
AQ04=00.00mA
```

When AQ output mode is the current mode, the correspondence between DR value, AQ current value and the displayed value is as follows:
DRD5 current value=2047, corresponding AQ02=500, displayed value: 20.00mA.

* When the preset value type of AQ is set as constant, value of the corresponding DR register is changed and AQ output value is modified accordingly ($AQx=DRx/4.095$);

* When the preset value type of AQ is set as other parameter variable, value of DR register varies with AQ ($DRx=AQx*4.095$).

Example 1: AQ01 preset value as a constant.

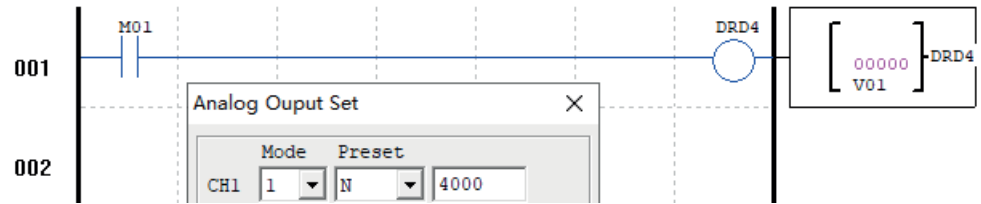

During running, M01 is not enabled, DRD4 current value is AQ01 set value 4000, and AQ01 outputs 9.77V.

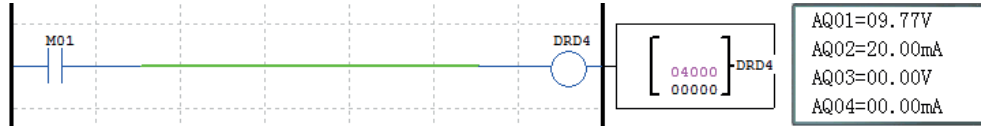

When M01 is enabled, DRD4 output is V01 value, and AQ01 output varies while V01 value is regulated.

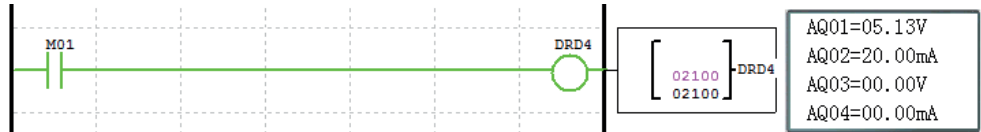

Example 2: AQ01 preset value as other parameter.

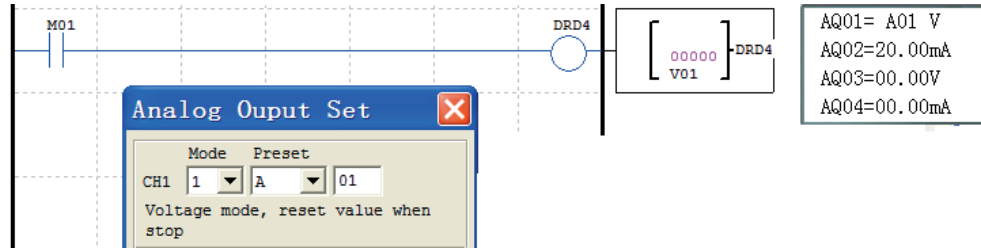

During running, DRD4 block output is not controlled by enabling, and AQ01 output value and DRD4 change while A01 is regulated.

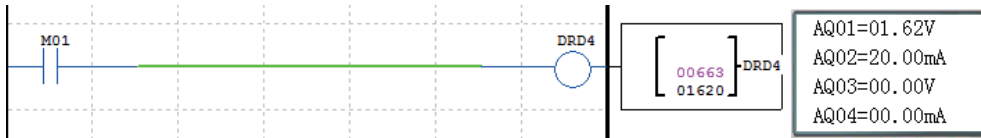

AS (ADDITION AND SUBTRACTION) INSTRUCTIONS

LRK includes 31 independent AS instructions for data addition and subtraction. AS instruction has 6 parameters, the display and meaning of which are provided below.

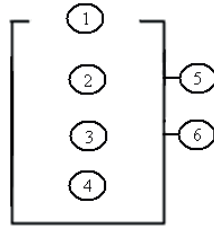

Symbol	Description
①	AS current value: -32768-32767
②	V1: operand 1: -32768-32767
③	V2: operand 2: -32768-32767
④	V3: operand 3: -32768-32767
⑤	Error output coil (M, N, NOP)
⑥	AS code (AS01-AS1F)

$$\text{Computing formula: } AS = V1 + V2 - V3$$

Operand V1-V3 may be a constant or code of current value of another functional block. Error coil is set ON in case of AS result overflow, or there will be no response if error coil is NOP.

Display and editing interface of AS instructions are shown below

* Coil N01 is set ON when the computed result exceeds the range of current value.

MD (MULTIPLICATION AND DIVISION) INSTRUCTIONS

LRK includes 31 independent MD instructions for data multiplication and division. MD instruction has 6 parameters, the display and meaning of which are provided below.

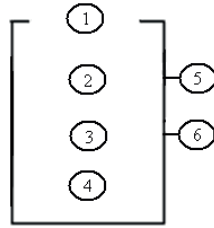

Symbol	Description
①	MD current value: -32768-32767
②	V1: operand 1: -32768-32767
③	V2: operand 2: -32768-32767
④	V3: operand 3: -32768-32767
⑤	Error output coil (M, N, NOP)
⑥	MD code (MD01-MD1F)

Computing formula: $MD = V1 * V2 / V3$

Operand V1-V3 may be a constant or code of current value of another functional block. Error coil is set ON in case of MD result overflow or V3=0, or there will be no response if error coil is NOP.

* Error events:

1. Operand V3 is 0, in which case multiplication and division will not be executed;
2. Overflow of computed result.

Display and editing interface of MD instructions are shown below:

The diagram illustrates the MD instruction symbol, a physical display of the MD01 instruction, and the 'Edit Contact/Coil' software interface. The physical display shows the MD01 instruction with a current value of 00000 and operands V01 (16586) and A01. The software interface shows the 'Edit Contact/Coil' window with the MD instruction selected, the current value set to 00000, and the function set to MD=V1*V2/V3. The interface also shows the preset values for V1 (16586), V2 (00001), and V3 (00001), and the pre-type settings (N, V, A).

PID INSTRUCTIONS

LRK includes 15 independent PID instructions for PID operation of integer data. PID instruction has 9 parameters, the display and meaning of which are provided below.

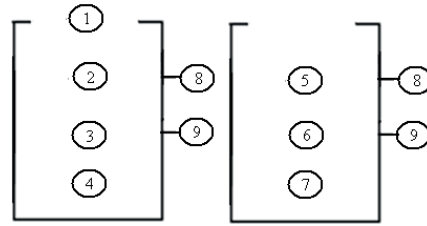

Symbol	Description
①	PI: PID current value (-32768~32767)
②	SV: target value (-32768~32767)
③	PV: measured value (-32768~32767)
④	TS: sampling time (1~32767 * 0.01s)
⑤	KP: proportional gain (1~32767%)
⑥	TI: integral time (1~32767 * 0.1s)
⑦	TD: differential time (1~32767 * 0.01s)
⑧	Error output coil (M, N, NOP)
⑨	PID code (PI01~PI0F)

Parameter ①~⑦ may be a constant or code of current value of another functional block. Error coil is set as 1 and PID function is not executed when TS or KP is 0.

PID computing formula:

$$EV_n = SV - PV_n$$

$$\Delta PI = K_P \left\{ (EV_n - EV_{n-1}) + \frac{T_s}{T_I} EV_n + D_n \right\}$$

$$D_n = \frac{T_D}{T_s} (2PV_{n-1} - PV_n - PV_{n-2})$$

$$PI = \sum \Delta PI$$

Display and editing interface of PID are shown below:

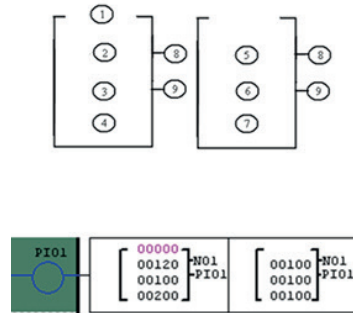

X

Edit Contact/Coil

L MU AS MD PI MK ◀ ▶

Select Coil No. Error Coil

PID 03 (01-0F) Symbol N 01

Function

Current value:

PID (-32768~32767)

SV:	N	<input type="text" value="00120"/>	<input type="text"/>	(-32768~32767)
PV:	N	<input type="text" value="00100"/>	<input type="text"/>	(-32768~32767)
TS:	N	<input type="text" value="00200"/>	<input type="text"/>	(1~32767)
Kp:	N	<input type="text" value="00100"/>	<input type="text"/>	(1~32767)
Ti:	N	<input type="text" value="00100"/>	<input type="text"/>	(1~32767)
Td:	N	<input type="text" value="00100"/>	<input type="text"/>	(1~32767)

OK Cancel

There are three basic types of controller:

Proportional controller (P);

Integral controller (I);

Differential controller (D);

The controllers form the proportion integration differentiation controller (PID controller). Functions of the basic controllers are explained below.

Proportional controller

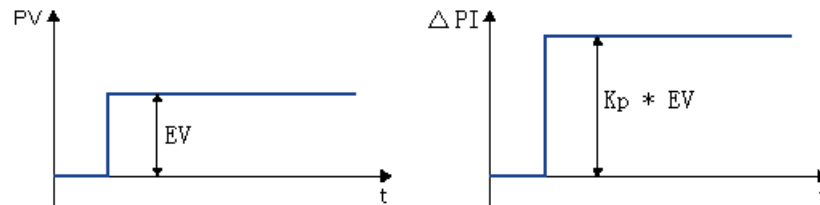
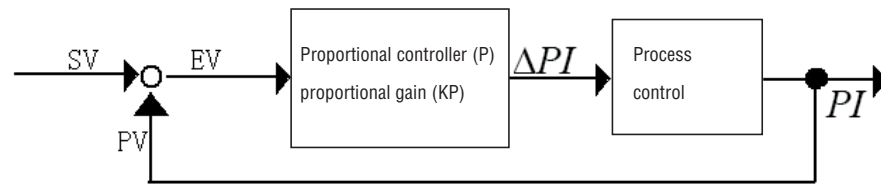

Based on the error EV between the target value SV and measured value PV , the regulated variable PI is changed proportionally (K_p) to change the output result PI of process control.

Proportional controller can work immediately, but it cannot make error 0.

Proportional controller characteristics: Respond to variation of process value immediately.

Integral controller

Integral controller changes the regulated variable ΔPI in proportion to loop error EV and time t , works based on the delayed operation, and can completely eliminate loop error.

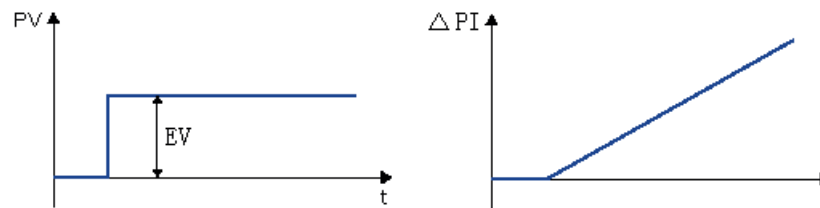

Integral controller characteristics: Eliminating error, delayed in operation and unstable.

Differential controller

Differential controller changes the regulated variable ΔPI in proportion to variation of the measured value PV to control the output result PI. In response to variation of the measured value PV, it changes the regulated variable to quickly complete the transition process. Differential controller characteristics: overcoming oscillation, improving stability and speeding up the transition process.

PID controller characteristics: Fast, stable and accurate.

The three parameters K_P , T_I and T_D of PID control are described below:

A large K_P may speed up regulation and reduce error, but excessive K_P will impair system stability and even lead to system instability; integral regulation continues till there is no error, and low T_I results in strong integral action and vice versa; differential control has early control action to eliminate error before it is generated; therefore, differential control can improve dynamic performance of system; in addition, a large T_D can speed up system response, reduce overshoot and improve stability, but it may impair system resistance to disturbance and result in sensitive response to disturbance; however, we actually expect system not to be extremely sensitive to disturbance; therefore, T_D should not be too large.

Effects of K_P , T_I and T_D on output curve are shown below.

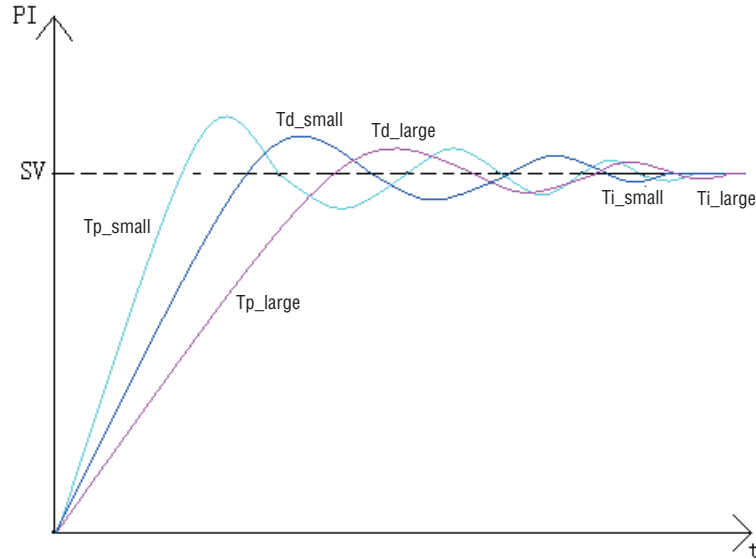

Small T_s will increase controller load, and minor deviation variation between two samplings will lead to insignificant variation of controller output value; large T_s may improve system stability, but result in poor control quality.

Parameter setting reference:

Control quantity	Application scenario	K_P (%)	T_I (*0.1s)	T_D (*0.01s)	T_s (*0.01s)
Rapid temperature	Small space or capacity	625	30	100	50
Slow temperature	Large space or capacity	1250	120	800	100
Slow pressure	Slow pressure change	1500	5	400	100
Rapid pressure	Rapid pressure change	3750	2	1000	100

K_P , T_I and T_D may be adjusted as per the curve chart in specific scenarios.

MX (MULTIPLEX CONTROLLER) INSTRUCTIONS

LRK includes 15 independent MX (multiplex controller) instructions, and each MX instruction has 7 parameters as listed below. When MX is disabled, MX current value is 0; when MX is enabled, MX current value is one of the parameters ①~④ based on status of ⑤ and ⑥, namely parameter is output.

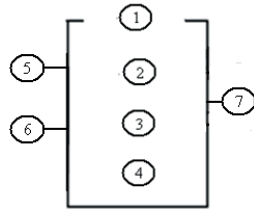

Symbol	Description
①	Operand V0: -32768 ~32767
②	Operand V1: -32768 ~32767
③	Operand V2: -32768 ~32767
④	Operand V3: -32768 ~32767
⑤	Control selection bit 1: S1
⑥	Control selection bit 2: S2
⑦	MX code (MX01~MX0F)

Operand V1~V4 may be a constant or code of other data type. The relation between control selection bit and MX current value is shown in the following table.

MX disabled	MX = 0
MX enabled	S1 = 0, S2 = 0; MX = V0; S1 = 0, S2 = 1; MX = V1; S1 = 1, S2 = 0; MX = V2; S1 = 1, S2 = 1; MX = V3;

Display and editing interface of MX are shown below:

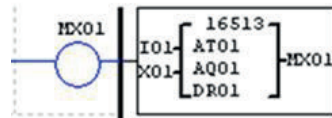
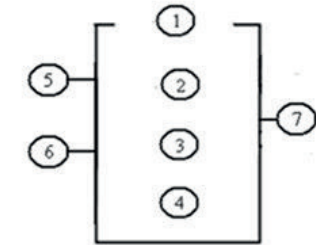

Edit Contact/Coil

MU | AS | MD | PI | **MX** | AR

-Select Coil No.
MX 01 (01-0F) Symbol

-Function
Current value:
Data multiplexer (Output value selected by S1 and S2)

Preset Value0: N 16S13

Preset Value1: AT 01

Preset Value2: AQ 01

Preset Value3: DR 01

S1 S2
Contact Low Contact X 01

OK Cancel

AR (RAMP FUNCTION GENERATOR) INSTRUCTIONS

LRK includes 15 independent AR (ramp function generator) instructions which are used to make the current level of AR change to the set level gradually at the set rate by operation of integer data. Each AR instruction has 2 modes.

AR mode 1

In mode 1, AR current value changes from the starting level to the target level at stepping rate. The following 12 parameters should be set for AR mode 1 setting.

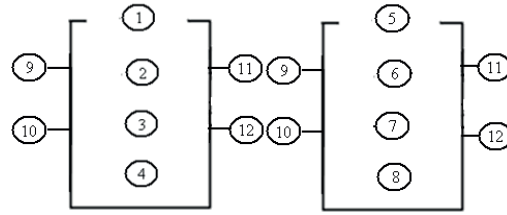

Symbol	Description
①	AR current value (AR: 0~32767)
②	Level 1 (Levl1: -10000~20000)
③	Level 2 (Levl2: -10000~20000)
④	Maximum level (MaxL: -10000~20000)
⑤	Start/Stop offset (StSp: 0~20000)
⑥	Stepping rate (Rate: 1~10000/s)
⑦	Gain (A: 0~10.00)
⑧	Offset (B: -10000~10000)
⑨	Level selection (Sel)
⑩	Stop coil (St)
⑪	Error output coil (M, N, NOP)
⑫	AR code (AR01~AR0F)

$$AR \text{ current value} = (AR \text{ current level} - \text{offset } B) / \text{gain } A$$

Parameter ②~⑧ may be a constant or code of other data type; error coil is set ON and AR instruction is not executed when gain A is 0.

Level selection coil Sel	Level selection rule Sel = 0: Lev1 as the target level Sel = 1: Lev2 as the target level * MaxL is taken as the preset value of target level if the target level is higher than the maximum level.
Stop coil St	When the stop coil is set ON (not kept), AR is stopped, decreased gradually from the current level to "Start/Stop offset+ offset" and kept at the level for 100ms, then the current level is offset B, leading to the current value 0, when AR instruction is ended.

After AR is enabled, the current level is kept at "Start/Stop offset+ offset" for 100ms, and then changed to the set level at the set stepping rate. If the stop coil is enabled, AR level is gradually decreased from the current level to "Start/Stop offset+ offset" at the set stepping rate and kept at this level for 100ms, then the current level is offset B, making AR current value 0, when AR instruction ends.

Timing diagram of AR current level:

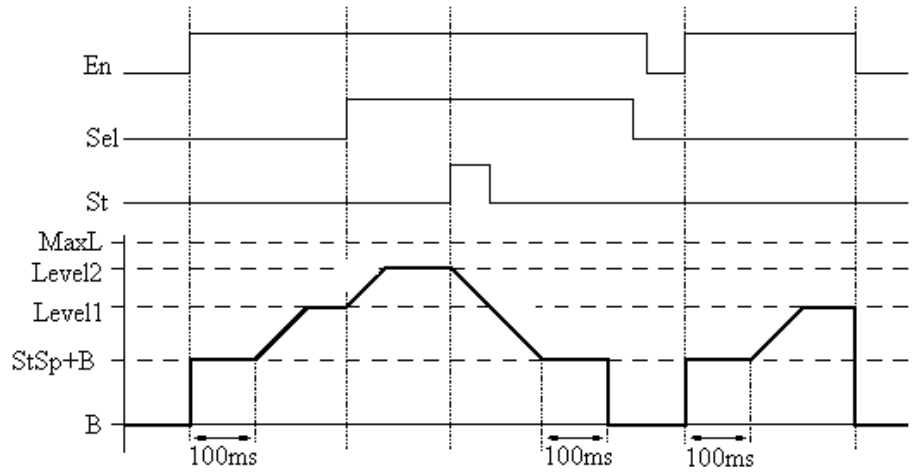

Display and editing interface of AR are shown below.

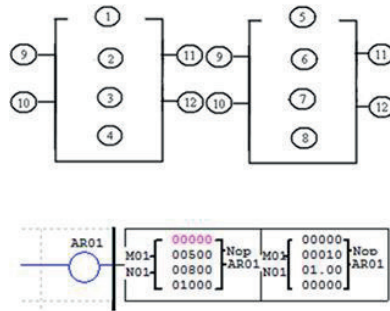

Edit Contact/Coil

AS MD PI MX AR DR

Select Coil No. AR 01 (01-0F) Symbol1 Error Coil NOP

Function Mode 1 (1-2)
AR=(Level-Offset)/Gain

Current value:

Level1:	N	00500	(-10000-
Level2:	N	00800	(-10000-20000)
MaxL:	N	01000	(-10000-20000)
StSp:	N	00000	(0-20000)
Rate:	N	00010	(1-10000)
Gain:	N	01.00	(0-10.00)
Offset:	N	00000	(-10000-10000)

Sel Contact M 01 St Contact N 01

OK Cancel

AR mode2

In mode 2, the four output levels L0-L3 can be set, and at the same time, one of the levels can be output as the target level as per the level selection ports Sel1 and Sel2. AR mode 2 has 12 parameters for setting.

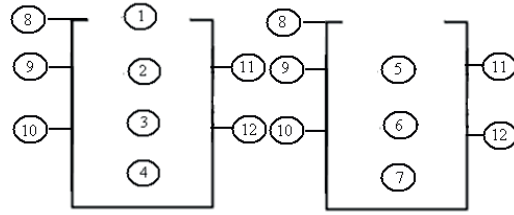

Symbol	Description
①	AR current value (AR:0~32767)
②	Level 0 (Level0:0~32767)
③	Level 1 (Level1:0~32767)
④	Level 2 (Level2:0~32767)
⑤	Level 3 (Level3:0~32767)
⑥	Level upper limit (MaxL: 0~32767)
⑦	Acceleration time (Ta:0.1~3276.7)
⑧	Mode
⑨	Level selection 1(Sel1)
⑩	Level selection 2(Sel2)
⑪	Error output coil (M, N, NOP)
⑫	AR code (AR01~AR0F)

Parameter ②~⑦ may be a constant or current value of another functional block. AR output variation rate:

$Rate = \frac{MaxL}{Ta}$. Refer to the following table for description of parameters:

Sel1 Sel2	S1 = 0, S2 = 0: target level = Level 0; S1 = 0, S2 = 1: target level = Level 1; S1 = 1, S2 = 0: target level = Level 2; S1 = 1, S2 = 1: target level = Level 3;
MaxL	MaxL is taken as the target level if the target level is higher than the maximum level.
Ta	Quotient of MaxL/Ta rate as AR output variation rate

After AR is enabled, AR output will change from 0 to the target level at $Rate = \frac{MaxL}{Ta}$. In response to variation of Sel1 and Sel2, AR output will subsequently change from the current level to the target level at the Rate. After AR is disabled, AR output will turn to 0 immediately. Refer to the timing diagram in the next page.

Timing diagram of AR mode 2

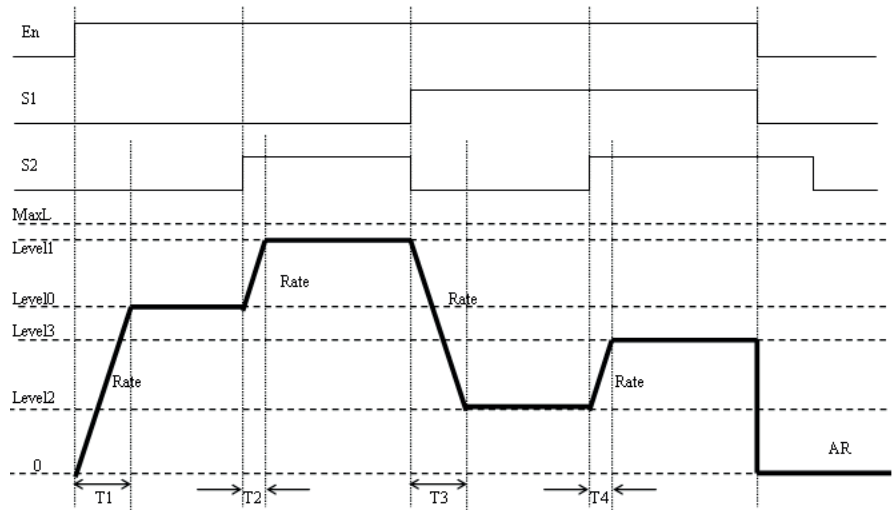

$$\text{Rate} = \text{MaxL}/\text{Ta}; \quad T1 = \text{Level0} * \text{Ta} / \text{MaxL}; \quad T2 = (\text{Level1} - \text{Level0}) * \text{Ta} / \text{MaxL};$$

$$T3 = (\text{Level1} - \text{Level2}) * \text{Ta} / \text{MaxL}; \quad T4 = (\text{Level3} - \text{Level2}) * \text{Ta} / \text{MaxL};$$

Example:

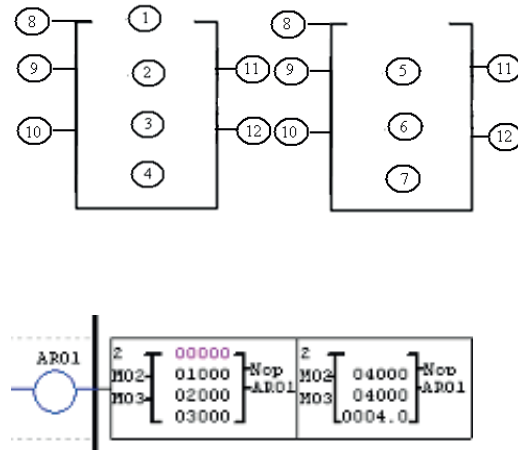

The 'Edit Contact/Coil' dialog box shows the configuration for AR mode 2. The 'Function' is set to 'AR' and the 'Mode' is '2'. The 'Current value' field is empty. The 'Level' settings are: Level0: 01000, Level1: 02000, Level2: 03000, Level3: 04000, and MaxL: 04000. The 'Ta' (time constant) is set to 0010.0. The 'Error Coil' is set to 'NOP'. The 'Sel1' and 'Sel2' sections show contact configurations: Sel1 Contact M 02 and Sel2 Contact N 03.

DR (DATA REGISTER) INSTRUCTIONS

LRK includes 240 independent DR (data register) instructions, and each DR instruction has 3 parameters. When DR is enabled, the preset value is transferred to DR current value register. Data in DR may be the type with symbol or the type without symbol, and the control bit can be set by LRK user programming software menu Operation (O)>>Module system setting(Y)...or keypad. Display and data type setting are provided below.

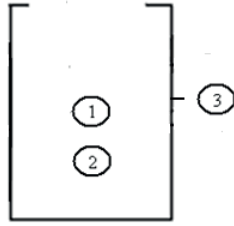

Symbol	Description	Range
①	DR current value	data without symbol, 0-65535
②	DR preset value	data with symbol, -32768-32767
③	DR code (DR01~DRF0)	

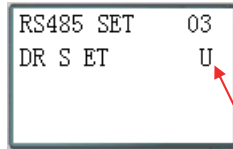

U: data without symbol
S: data with symbol

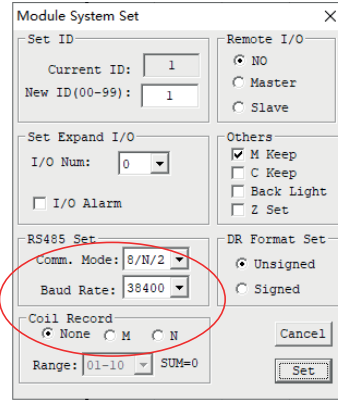

DR preset value may be a constant or code of current value of another functional block. Display and editing interface of DR are shown below.

Menu interface DR register: DR preset value is displayed in STOP mode, and DR current value is displayed in RUN mode.

STOP	RUN (DR01 = C01 current value)
DR01 = C01	DR01 = 00009
DR02 = 00000	DR02 = 00000
DR03 = 00000	DR03 = 00000
DR04 = 00000	DR04 = 00000

* Current value of DR65~DRF0 is kept in case of power failure or in the STOP mode.

* The final 40 DRs are special data registers, as listed below.

DRD0~DRE3 are special registers for parameter setting, the current value output function of which is described below.

DRC9~DRCF and DRD9~DRF0 are special status registers, the current value output function of which is described below:

No.	Function description	
DRC9	PLSY instruction for output of current value of pulse number	
DRCA	AT01 current Fahrenheit	Used as general DR register when there is no AT01~AT04 (4PT not connected)
DRCB	AT02 current Fahrenheit	
DRCC	AT03 current Fahrenheit	
DRCD	AT04 current Fahrenheit	
DRCE	RTC mode5 sunrise time	
DRCF	RTC mode5 sunset time	
DRD9~DRDF	Saving RTC current value	Year month day week hour minute second
DRE0	Finally enabled M/N number	M/N range selected for status memory in system setting, and the finally enabled M/N number recorded in DRE0 during program running
DRE1~DRE3	Standby special status registers	
DRE4	A05 input current 0~2000	Used as general DR register when there is no A05~A08 (4AI not connected)
DRE5	A06 input current 0~2000	
DRE6	A07 input current 0~2000	
DRE7	A08 input current 0~2000	
DRE8	A01 current value 0~4095	Used as general DR register when there is no A01~A02 (for AC type)
DRE9	A02 current value 0~4095	
DREA	A03 current value 0~4095	Used as general DR register when there is no A03~A04 (for AC type for 12 points DC)
DREB	A04 current value 0~4095	
DREC	A05 current value 0~4095	Used as general DR register when there is no A05~A08 (4AI not connected)
DRED	A06 current value 0~4095	
DREE	A07 current value 0~4095	
DREF	A08 current value 0~4095	
DRF0	Standby special status registers	

Chapter 6 FBD Programming Instructions

Chapter 6 FBD Programming Instructions	121
FBD Coil	122
FBD Program Storage Space	123
Analog Coil	125
Analog input	125
Analog output	126
Coil Blocks	127
HMI graph block	128
IO Link graph block (for LRK20RD024RS type only).	129
SHIFT graph block	131
Logic Block Diagrams	132
AND logic block diagram	132
AND (EDGE) logic block diagram	132
NAND logic block diagram	133
NAND (EDGE) logic block diagram	133
OR logic block diagram	133
NOR logic block diagram	134
XOR logic block diagram	134
RS logic block diagram	134
NOT logic block diagram	135
Pulse logic block diagram	135
BOOLEAN logic block diagram	135
Functional Block Diagrams	136
Timer functional block diagram	137
General counter functional block diagram	146
High-speed counter functional block diagram (for DC type only)	152
RTC functional block diagram	155
Analog comparator functional block diagram	161
Filter functional block diagram	164
Addition and subtraction functional block diagram	166
Multiplication and division functional block diagram	167
PID functional block diagram	168
Multiplex controller (MX) functional block diagram	169
Ramp function generator (AR) functional block diagram	170
Data register (DR) functional block diagram	173
Modbus functional block diagram	174

FBD COIL

	Input	Output	Range
Input coil	I		12 (I01~I0C)
Key input	Z		4 (Z01~Z04)
Extended input	X		12 (X01~X0C)
Output coil	Q	Q	8 (Q01~Q08)
Extended output	Y	Y	12 (Y01~Y0C)
Auxiliary contact	M	M	127(M01~M7F)
Auxiliary contact	N	N	127(N01~N7F)
HMI		H	31 (H01~H1F)
PWM		P	2 (P01~P02)
SHIFT		S	1 (S01)
I/O LINK		L	8 (L01~L08)
Logic block/functional block	B	B	260 (B001~B260)
NC contact	Hi		
NO contact	Lo		
Not connected	Nop		
Analog input	A		8 (A01~A08)
Analog input parameter	V		8 (V01~V08)
Analog output		AQ	4 (AQ01~AQ04)
Analog temperature input	AT		4 (AT01~AT04)
Network input	J		63 (J01~J3F)
Network output		K	63 (K01~K3F)
Network analog input	NI		31 (NI01~NI1F)
Network analog output		NQ	15 (NQ01~NQ0F)

User can only edit and modify FBD program in LRXSW programming software, write in LRK lower computer by programming communication cable, and check parameters of the used functional block in FBD program or the modified program. The preset value of block may be a constant or code of another block current value. Block parameter limit is taken as the preset value in case of decoded data overflow.

FBD PROGRAM STORAGE SPACE

LRK provides limited resource for FBD program:

Number of graph block B	System memory (byte)
500	10000

* The size of each block diagram B varies with its function.

* Functional block diagrams include: special functional block diagram, regulating functional block diagram and serial port communication functional block diagram. Specific functions and quantitative limits are listed below.

	Functional block diagram	Quantity
Special functional block diagram	Timer (T)	250
	Counter (C)	250
	RTC (R)	250
	Analog comparator (G)	250
	Filter (F)	250
Regulating functional block diagram	Addition and subtraction (AS)	250
	Multiplication and division (MD)	250
	PID control (PI)	30
	Multiplex controller (MX)	250
	Ramp function generator (AR)	30
	Data register (DR)	240
	Network analog input (NAI)	250
	Network analog output (NAQ)	250
Serial port communication functional block diagram	Modbus instruction (MU)	250

* Each functional block uses 1 B. The available quantity depends on number of B, system memory space and number of functional blocks.

	Number of graph blocks B	System memory (byte)	Number of functional blocks														
			T	C	R	G	AS	MD	PI	MX	AR	DR	MU	F	NAI	NAQ	
Total resource	500	10000	2500	250	250	250	250	250	250	30	250	30	240	250	250	250	250
Timer mode 0	1	5	1														
Timer mode 1~6	1	10	1														
Timer mode 7~8	1	12	2														
Counter mode 0	1	5		1													
Counter mode 1~7	1	14		1													
Counter mode 8	1	16		1													
RTC mode 0	1	5			1												
RTC mode 1~5	1	11			1												
Comparator mode 0	1	5				1											
Comparator mode 1~4	1	12				1											
AS	1	11					1										
MD	1	11						1									
PID	1	17							1								
MX	1	17								1							
AR	1	23									1						
DR	1	6										1					
MU	1	12											1				
Filter mode 0	1	5												1			
Filter mode 1~4	1	10												1			
NAI	1														1		
NAQ	1																1

* Logic block diagrams include AND, AND EDGE, NAND, NAND EDGE, OR, NOR, XOR, NOT, RS, PULSE and BOOLEAN functions; each logic block uses 1 B, and the available quantity is limited by number of B and system memory space.

Logic function block	Number of graph blocks B	System memory (byte)
AND	1	8
AND(EDGE)	1	8
NAND	1	8
NAND(EDGE)	1	8
OR	1	8
NOR	1	8
XOR	1	6
RS	1	6
NOT	1	4
PULSE	1	4
BOOLEAN	1	12

Example and resource computing

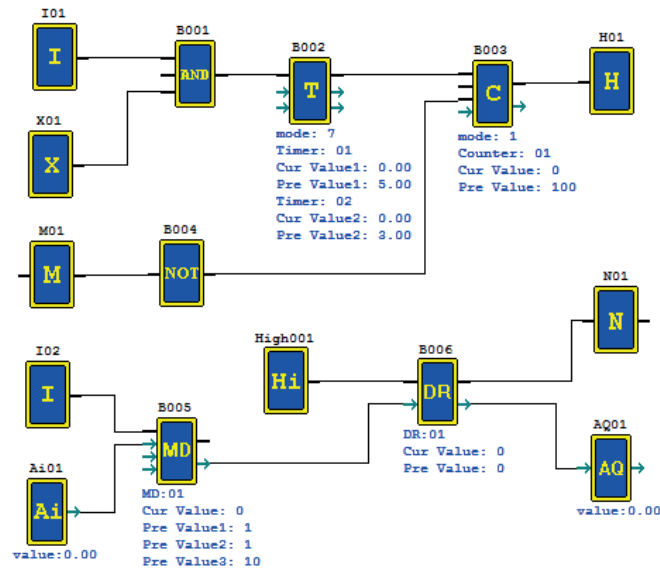

I01, X01, M01 and I02 are coil input; H01 and N01 are coil output; Hi001 is normally closed (NC) input; A01 is analog input; AQ01 is analog output; B001-B006 are logic and functional block diagrams. Coil I/O and analog I/O do not occupy B and memory

No.	Function	Memory byte	Number of functional blocks
B001	AND (and)	8	
B002	Timer T mode 7	12	T01, T02
B003	Counter C mode 1	14	C01
B004	NOT (not)	4	
B005	Multiplication and division MD	11	MD01
B006	Data register DR	6	DR01

	B number	Memory byte	
Available resource	500	10000	
Occupied resource	6	55	
Free resource	494	9945	

ANALOG COIL

Analog coil includes analog input A01~A04, extended analog input A05~A08, analog offset gain V01~V08, extended analog temperature input AT01~AT04 and extended analog output AQ01~AQ04. Analog value may be used as preset value of other functional blocks.

Analog input	A01~A04
Expansion analog input	A05~A08
Analog input count value	V01~V08
Expansion temperature input	AT01~AT04
Expansion analog output	AQ01~AQ04

Analog input

DC type body: Analog input A01~A04, value 0~999, corresponding to 0~9.99V; Extended module 4AI: Analog input A05~A08, value 0~999, corresponding to 0~9.99V;

Extended module 4PT: Analog temperature input AT01~AT04, value -1000~6000, corresponding to -100.0~600.0°C; Analog offset gain V01~V08, value range 0~999999, calculating relation: $V0x=A0x * \text{gain} + \text{offset}$.

Analog input	Number	Range	Meaning
Analog input value	A01~A04	0~999	0~9.99V
Expansion analog input value	A05~A08	0~999	0~9.99V
Analog input count value	V01~V08	0~999999	
Expansion temperature input value	AT01~AT04	-1000~6000	-100.0~600.0°C

Example: $A01=1.23$, $V01=A01 * 10 - 0 = 12.30$;
 $B001 (AS01)=A01+V01-AT01$

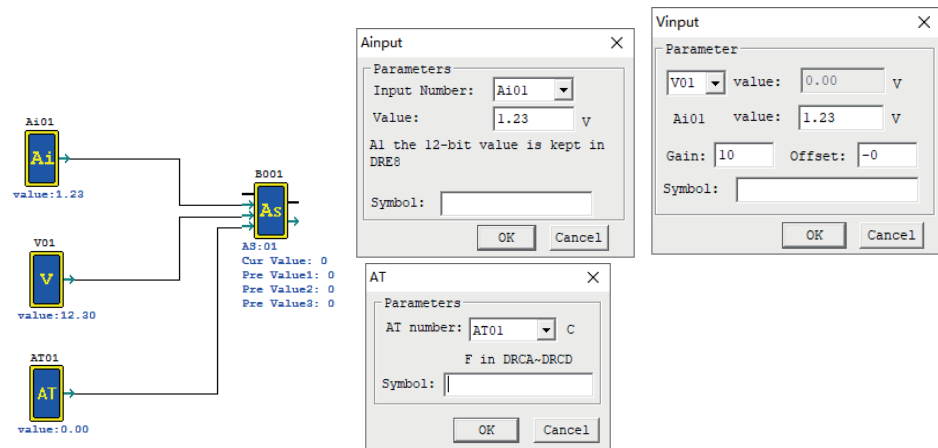

Refer to Chapter VIII: Extended Module Instructions-Analog Extended Modules for use of extended analog input module.

Analog output

AQ analog output instructions are used with extended analog output module 2AO.

Default output mode of AQ is voltage mode 0~10V, where 12bits value is 0~4095, and the corresponding AQ value is 0~1000.

When the output mode is set as current mode 0~20 mA, 12bits value is 0~2047, and the corresponding AQ value is 0~500.

The 12bits value of AQ is stored in register DRD4~DRD7. Output mode depends on the current value of DRD0~DRD3, as listed below.

	Output register	Mode register	Mode	DRD0~DRD3 data definition
Channel 1: AQ01	DRD4	DRD0	1	0: voltage mode, AQ output value is 0 in STOP mode
Channel 2: AQ02	DRD5	DRD1	2	1: current mode, AQ output value 0 in STOP mode
Channel 3: AQ03	DRD6	DRD2	3	2: voltage mode, AQ output value kept in STOP mode
Channel 4: AQ04	DRD7	DRD3	4	3: current mode, AQ output value kept in STOP mode

- * DRD0~DRD3 value is taken as 0 when it is not 0~3, namely AQ output mode is mode 1.
- * 2AO connected to the near-end of master corresponds to output AQ01 and AQ02, and that to the far-end corresponds to output AQ03 and AQ04.
- * Refer to Chapter VIII: Extended Module Instructions-Analog Extended Modules for use of analog output module.
- * When the preset value type of AQ is set as constant, value of the corresponding DR register is changed and AQ output value is modified accordingly ($AQx=DRx/4.095$);
- * When the preset value type of AQ is set as other parameter variable, value of DR register varies with AQ ($DRx=AQx*4.095$).

Example 1: AQ01 preset value as a constant.

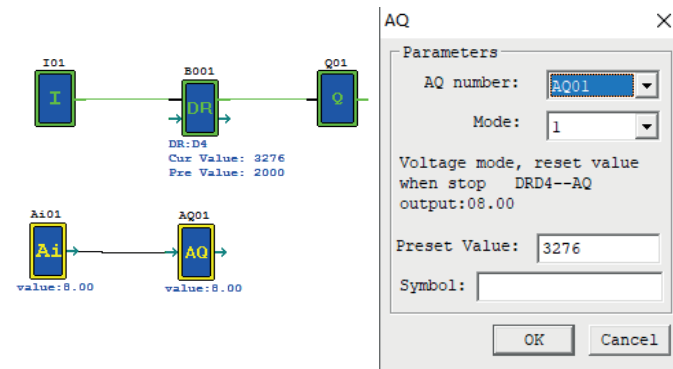

During running, I01 is not enabled, DRD4 current value is AQ01 set value 4000, and AQ01 outputs 9.77V; When I01 is enabled, AQ01 output varies while DRD4 value is regulated.

Example 2: AQ01 preset value as other parameter.

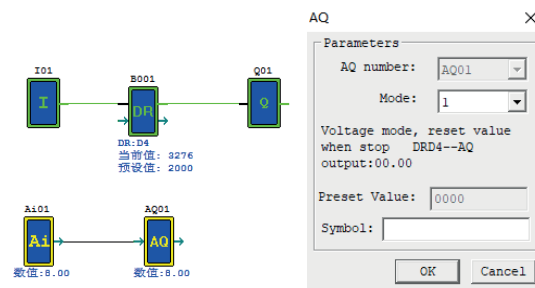

AQ01 output value and DRD4 vary with A01, while DRD4 output is not controlled by enabling.

COIL BLOCKS

Output coils include Q, Y, M, N, H, L, P and S; FBD menu display is shown below:

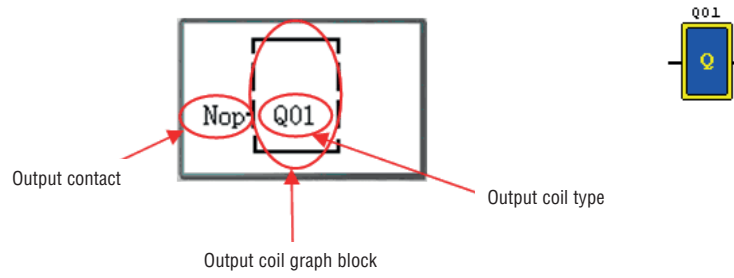

H, L, P and S special functional output coils; press "OK" to enter the functional display interface.

Press the following keys at this time:

OK	Enter the functional display interface when cursor is in the coil position and coil type is H, L, P or S.
→	Move the cursor, input contact → output coil → output coil number
←	Move the cursor, output coil number → output coil → input contact → logic/ functional display (when input contact is B)
↑↓	Change coil type Q ⇔ Y ⇔ M ⇔ N ⇔ H ⇔ L ⇔ P ⇔ S ⇔ Q... when cursor is in the coil position; Change coil number when cursor is in the position of coil number;

HMI GRAPH BLOCK

LRK includes 31 independent HMI instructions, and each HMI enables display of content in 16x4 characters on LCD in the form of text, figure, coil status, preset value and current value of functional block, and current value of analog. Text displayed by HMI has types multi-language and Chinese.

* Only the coil, functional block and analog quantity used in program are available for setting of display status, preset value and current value in HMI.

Each HMI has 2 working modes:

Mode 1, display mode, where the preset content is displayed when "SEL" is pressed on the initialization interface;

Mode 2, no-display mode, where the preset content is not displayed when "SEL" is pressed on the initialization interface, and can only be displayed while it is enabled.

Example: M01 controls H01; set to display status of coil M01, preset value and current value of functional block B001 (timer T01) and current value of block B002 (counter C01) in H01 mode 1.

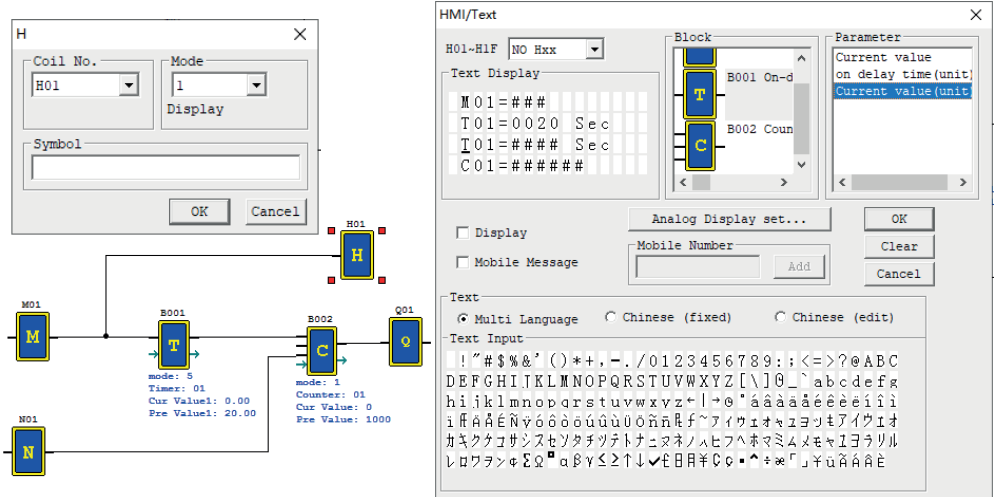

Coil output display under FBD	Press "OK" to enter functional display	Press "SEL" to modify the mode

HMI display and key editing method are consistent with that under Ladder.

Press "SEL" for display when stopped	Enable HMI display during running	Press "SEL" to modify the preset value of functional block

* Refer to Chapter III: Programming Tool-Ladder Programming Environment-HMI/TEXT for details on editing and use of HMI function.

IO LINK GRAPH BLOCK (FOR LRK20RD024RS TYPE ONLY)

An IO Link is composed of 8 micro-plc type LRK20RD024RS at most, where each contact is used as an independent station for running of its logic program and all slave contacts are connected to the same master station. IO Link ID must be continuous and be 0-7; master station ID is 0, and slave station ID begins from 1 to 7; if slave station ID is not continuous, such as 1, 2, 4, 5, the master station will take it as there are only two slave stations 1 and 2 and communicate with slave stations 1 and 2 only.

When each station uses L01~L08, only one can be set as mode 1: sending mode, and the other L can only be set as mode 2: receiving mode. Sending mode: Address in W table is controlled by ID of LRK itself and cannot be changed, and status of the selected coil is put in the corresponding W table. The correspondence of ID and W table is shown in the following table. Receiving mode: content of the selected W table is transferred to the selected coil; if input coil I or X is selected, content of W table will not change status of coils I and X.

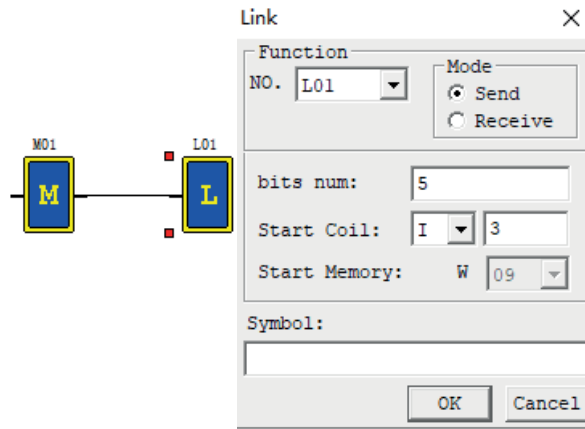

ID	W table comparison
0	W01-W08
1	W09-W16
2	W17-W24
3	W25-W32
4	W33-W40
5	W41-W48
6	W49-W56
7	W57-W64

Coil output display under FBD	Press OK to enter functional display	Press "SEL" to modify mode, coil number and type and W position
	<pre>I/O Link01 Mode:1 Num:5 I03→W09 I07→W13</pre>	<pre>I/O Link01 Mode:2 Num:5 M04→W17 M08→W21</pre>

Display description
L01: I/O Link code (L01~L08)
M01: enabling input (I01~B260)
Mode: IO Link mode, 1: sending ;2: receiving
Num x: sending/receiving points (1~8)
I03...I07: sending/receiving coil type
W09...W13: Position of sent/received data in W table

Coil type	Number
Input coil	I01~I0C/I01~i0C
Output coil	Q01~Q08/q01~q08
Auxiliary coil	M01~M3F/m01~m3F
Auxiliary coil	N01~N3F/n01~n3F
Extended input	X01~X0C/x01~x0C
Extended output	Y01~Y0C/y01~y0C

Example 1: Sending mode

The set mode is 1, coil number is 5, starting coil is I03 and LRK ID is 1, status of coil I03-I07 will be sent to W09-W13, as shown below.

Mode=1, Num= 5, coil= I03~I07, ID=1 (W09~W13)								
W table position	W09	W10	W11	W12	W13	W14	W15	W16
Receiving or sending coil	↑ I03	↑ I04	↑ I05	↑ I06	↑ I07	↑ 0	↑ 0	↑ 0

Example 2: Receiving mode

The set mode is 2, coil number is 5, starting coil is M03, W table position is W17 and not controlled by ID, content of W17-W21 will be sent to coil M03-M07.

Mode=1, Num = 5, coil = M03~M07, W table W17~W21					
W table position	W17	W18	W19	W20	W21
Receiving or sending coil	↓ M03	↓ M04	↓ M05	↓ M06	↓ M07

I/O Link02
Mode: 2 Num: 5
M03←W17
M07←W21

IO Link diagram:

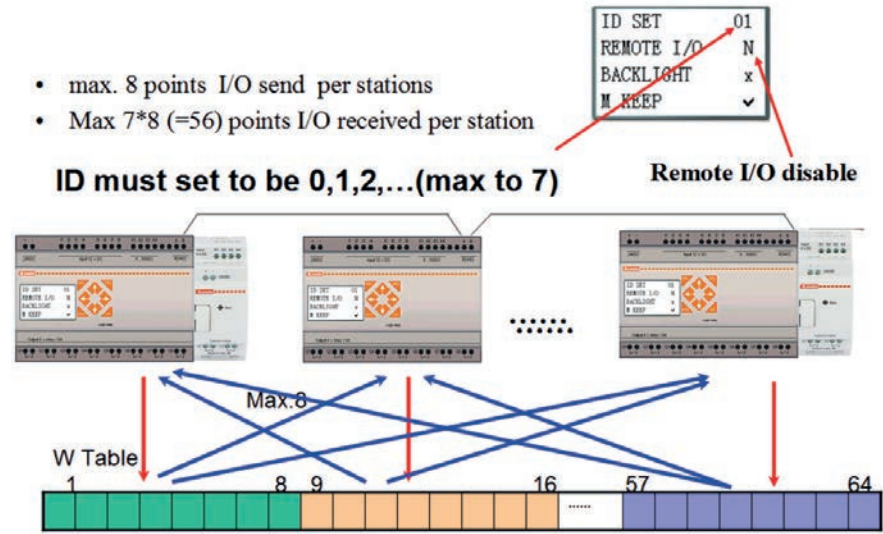

* Refer to Chapter VII: Function Specification of LRK20RD024RS Type for use of IO Link function.

SHIFT GRAPH BLOCK

LRK includes 1 SHIFT instruction, which is for cycling and alternating output of effective status at the specified contacts.

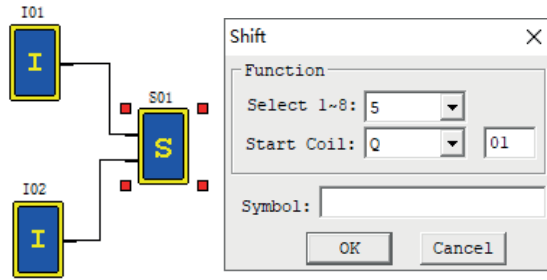

Coil output display under FBD	Press OK to enter functional display	Press "SEL" to modify coil number and type
	<p>Shift01</p> <p>Type: Q01-Q05</p> <p>Num: 5</p>	<p>Shift01</p> <p>Type: N03-N05</p> <p>Num: 3</p>

Display description
S01: SHIFT code (S01)
I01: enabling input (I01-B260)
I02: pulse input contact (I01~ B260)
Type: output contact
Num: number of output contacts (1-8)

Output contact	Number
Output coil	Q01-Q08
Extended output	Y01-Y0C
Auxiliary coil	M01-M3F
Auxiliary coil	N01-N3F

Timing diagram

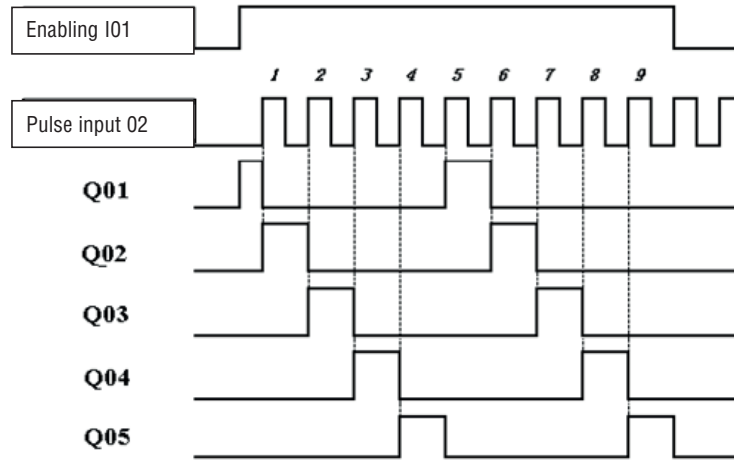

LOGIC BLOCK DIAGRAMS
Logic block display under FBD:

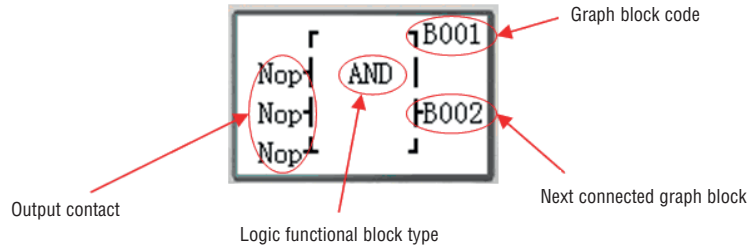

Press the following keys at this time:

→	Move the cursor, input contact → graph block code → next connected graph block/coil display
←	Move the cursor, graph block code → input contact → logic/functional display (when input contact is B)
↑↓	Move the cursor upward or downward (multiple input contacts)

* Logic block diagrams include AND, AND EDGE, NAND, NAND EDGE, OR, NOR, XOR, NOT, RS, PULSE and BOOLEAN functions.

AND logic block diagram

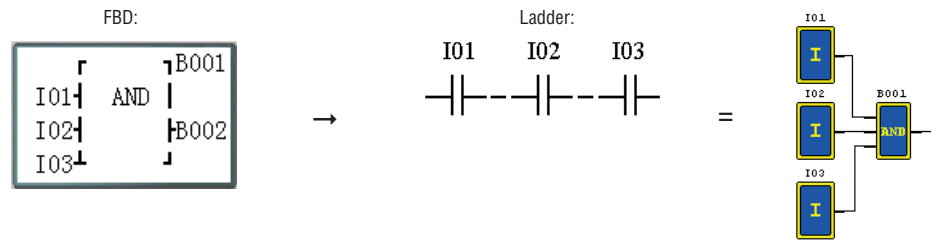

I01 And I02 And I03

- * Input contact NOP is equivalent to Hi;
- * B outputs ON when all input contacts are ON.

AND (EDGE) logic block diagram

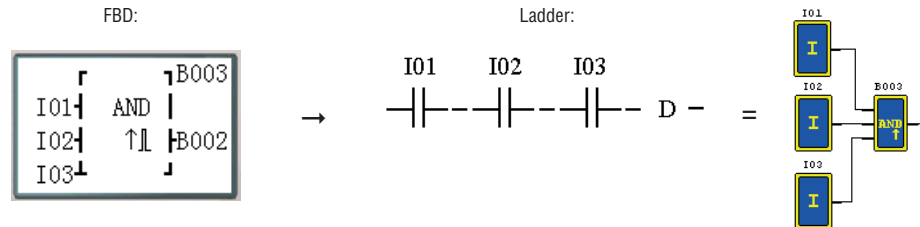

I01 And I02 And I03 And D

- * Input contact NOP is equivalent to Hi;
- * B outputs ON in a scanning cycle when all input contacts are ON.

NAND logic block diagram

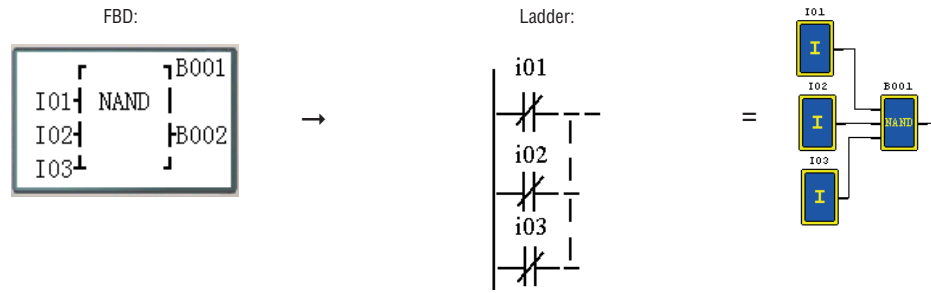

Not (I01 And I02 And I03)
 * Input contact NOP is equivalent to Hi;
 * B outputs ON when any input contact is OFF.

NAND (EDGE) logic block diagram

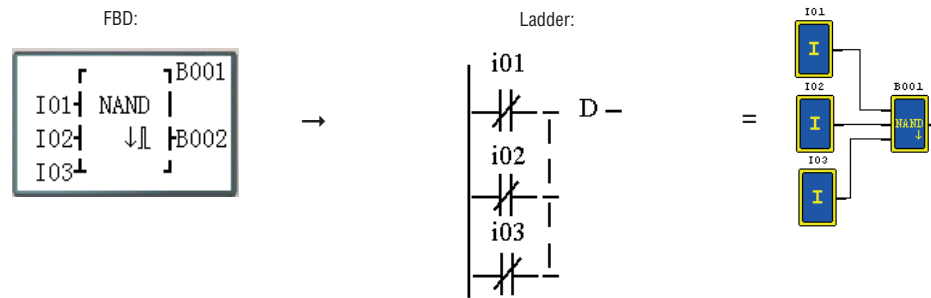

Not (I01 And I02 And I03) And D
 * Input contact NOP is equivalent to Hi;
 * B outputs ON in a scanning cycle when all input contacts are ON and any input is OFF.

OR logic block diagram

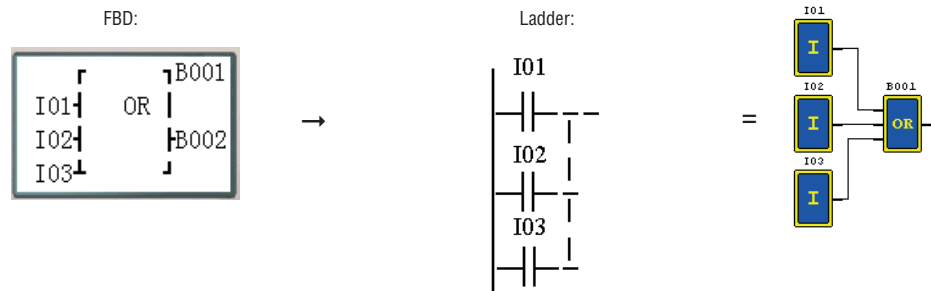

I01 or I02 or I03
 * Input contact NOP is equivalent to Lo;
 * B outputs ON when any input contact is ON.

NOR logic block diagram

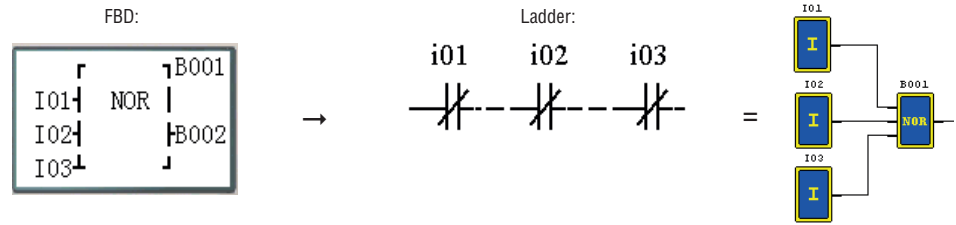

Not (I01 or I02 or I03)
 * Input contact NOP is equivalent to Lo;
 * B outputs ON when all input contacts are OFF.

XOR logic block diagram

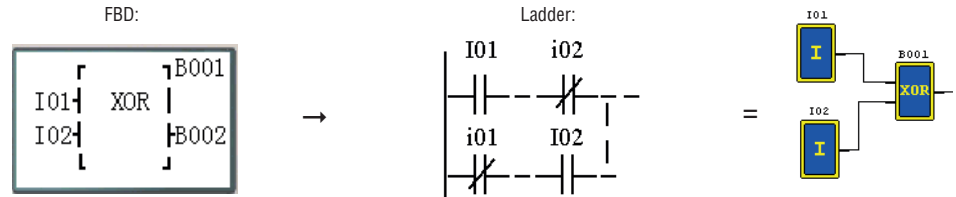

I01 XOR I02
 * Input contact NOP is equivalent to Lo;
 * B outputs ON when status of input contact is different.

RS logic block diagram

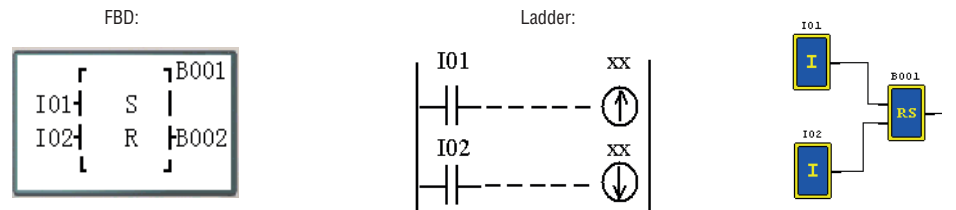

Truth table

I01	I02	B001
0	0	Kept
0	1	0
1	0	1
1	1	0

* Input contact NOP is equivalent to Lo.

NOT logic block diagram

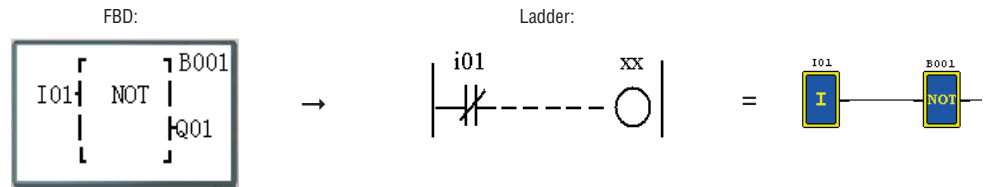

Not I01

* Input contact NOP is equivalent to Hi.

Pulse logic block diagram

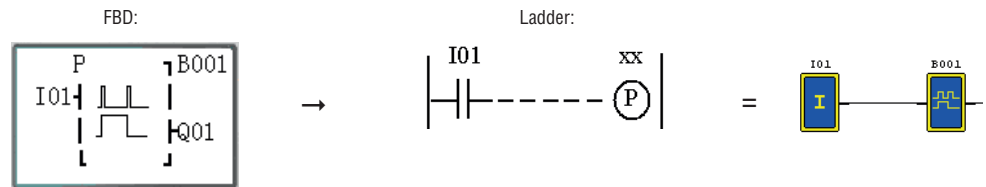

* Input contact NOP is equivalent to Lo;

* B output status changes when input contact status changes from OFF to ON.

BOOLEAN logic block diagram

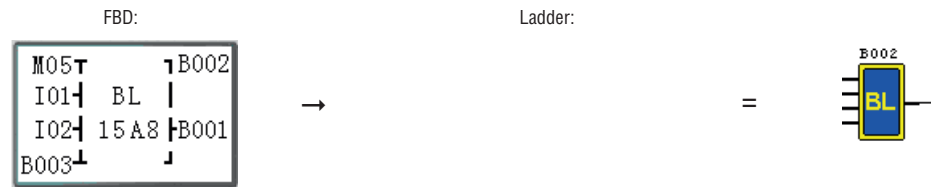

* Input contact NOP is equivalent to Lo.

Example of BOOLEAN function:

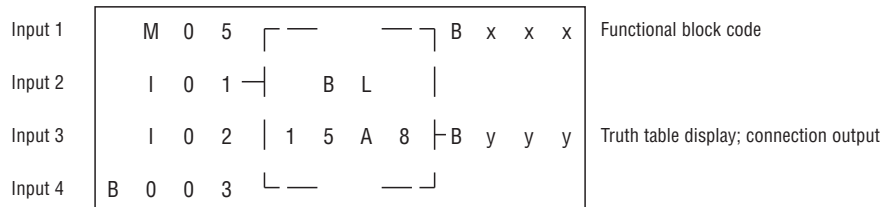

BOOLEAN truth table comparison is as follows:

Input1	Input2	Input3	Input4	Output (edit)	Example	Truth table display
0	0	0	0	0/1	0	8
1	0	0	0	0/1	0	
0	1	0	0	0/1	0	
1	1	0	0	0/1	1	
0	0	1	0	0/1	0	A
1	0	1	0	0/1	1	
0	1	1	0	0/1	0	
1	1	1	0	0/1	1	
0	0	0	1	0/1	1	5
1	0	0	1	0/1	0	
0	1	0	1	0/1	1	
1	1	0	1	0/1	0	
0	0	1	1	0/1	1	1
1	0	1	1	0/1	0	
0	1	1	1	0/1	0	
1	1	1	1	0/1	0	

FUNCTIONAL BLOCK DIAGRAMS

* Operation rule of all functional blocks in FBD mode is basically the same with that in Ladder mode.

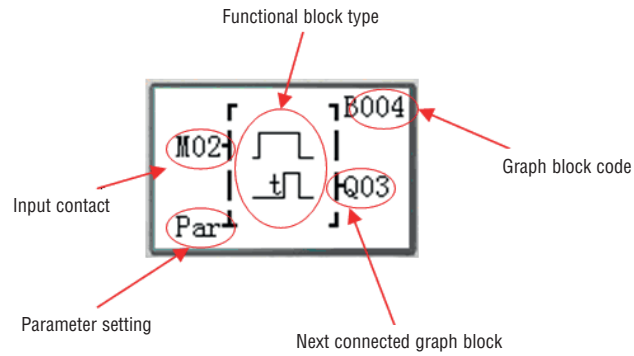

* When the cursor is in parameter setting "Par", press "OK" to enter the parameter display setting interface for editing and modifying the preset value of functional blocks.

Press the following keys at this time:

→	Move the cursor, input contact or parameter setting → graph block code → next connected graph block /coil display
←	Move the cursor, graph block code → input contact or parameter setting → logic/functional display (when input contact is B)
↑↓	Move the cursor upward or downward (input contact, parameter setting)
OK	Enter the functional block parameter display interface when cursor is in parameter setting

* Logic block diagrams include AND, AND EDGE, NAND, NAND EDGE, OR, NOR, XOR, NOT, RS, PULSE and BOOLEAN functions.

Display of functional block parameters:

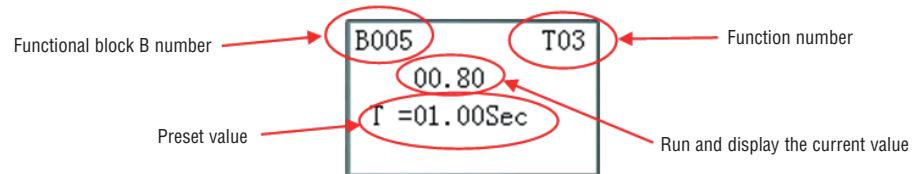

Press the following keys at this time:

← or →	Find the close functional block when cursor is in the position of B; Move the cursor to the left or right when it is in the position of preset value
SEL+ ↑ or ↓	Find the close functional block when cursor is in the position of B
SEL+ ← or →	Parameter display menu 1~2 switching when B is function PI, MX or AR
↑↓	Move the cursor upward or downward (B ↔ preset value); Modify value or number when status is edited
SEL	Modify value or number when status is edited;
ESC	Cancel the current editing; Exit the parameter display interface
OK	Confirm the current editing and save

TIMER FUNCTIONAL BLOCK DIAGRAM

Under FBD, 250 timers may be used at the maximum in mode 0-8 where the function is the same with that under Ladder.

- * In timer mode 7 under FBD, a functional block B uses two timers T.
- * When M KEEP is effective, the current values of timers TOE and TOF are kept in case of power failure.

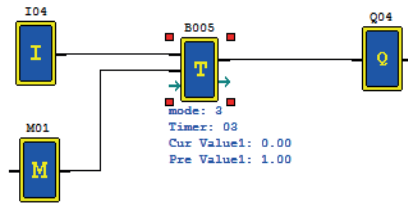

Timer editing and display:

FBD display:

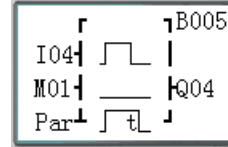

Parameter display:

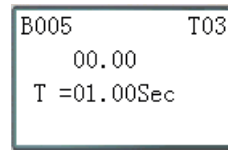

Timer Function Block

Function

Mode: Timer number:

Off-delay timer mode 1

Time Base:

Current Value: Sec

Preset Value: Sec

Symbol

OK Cancel

TIMER MODE 0 (INTERNAL COIL)

In mode 0, timer is used as internal auxiliary coil, there is no preset value and parameter display.

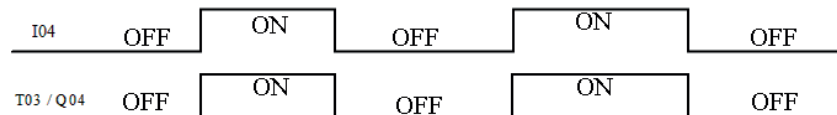
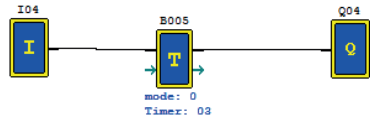
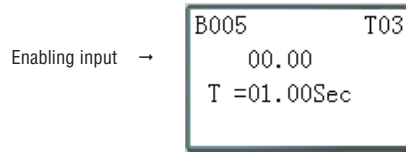

TIMER MODE 1 (ON-DELAY A MODE)

Timer begins timing when the control condition of timer mode 1 changes from OFF to ON, and it stops timing and the timer coil outputs ON when the current value of timing reaches the preset value. The current value of timer and coil status are reset to 0 when the timer control condition is OFF.

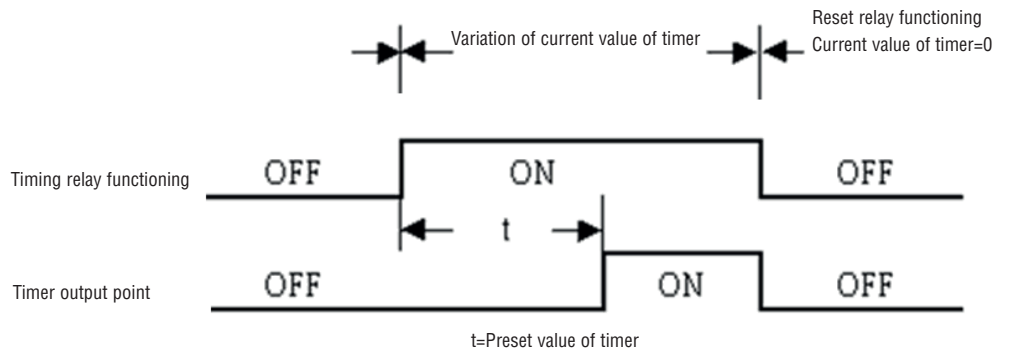
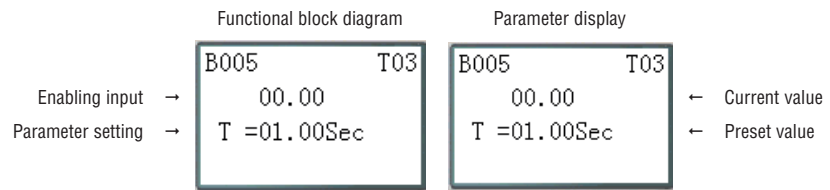
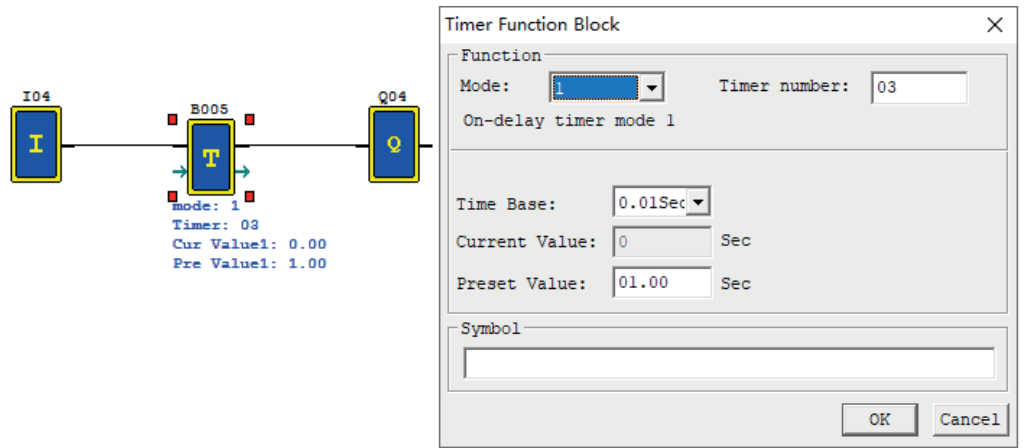

TIMER MODE 2 (ON-DELAY B MODE)

Timer mode 2 is designed with reset control. The timer begins timing when the control condition turns from OFF to ON, the current value of timer is kept when the control condition is OFF, and output coil is ON and timing is stopped when the current value of timer reaches the preset value. The current value of timer and coil status are reset to 0 when reset control is effective.

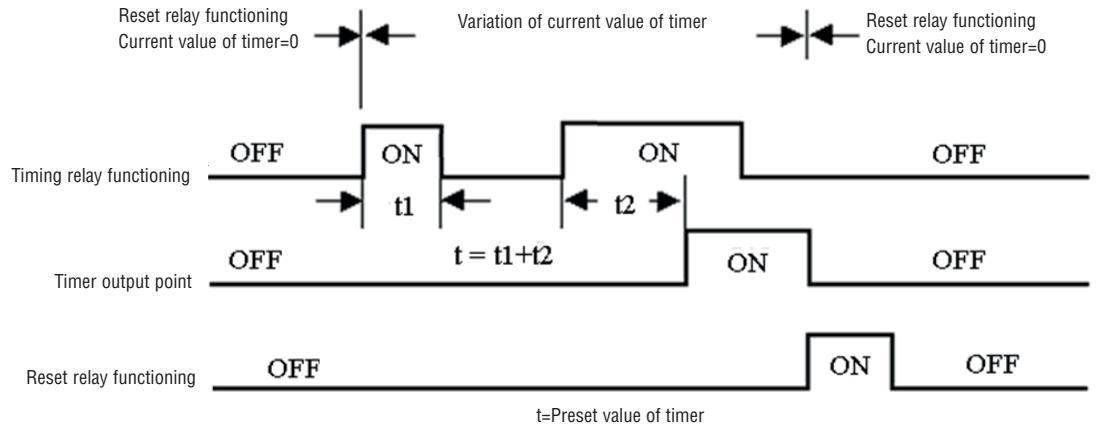
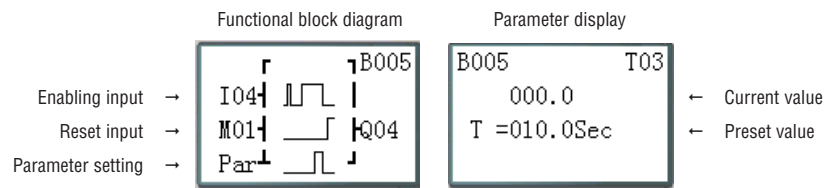
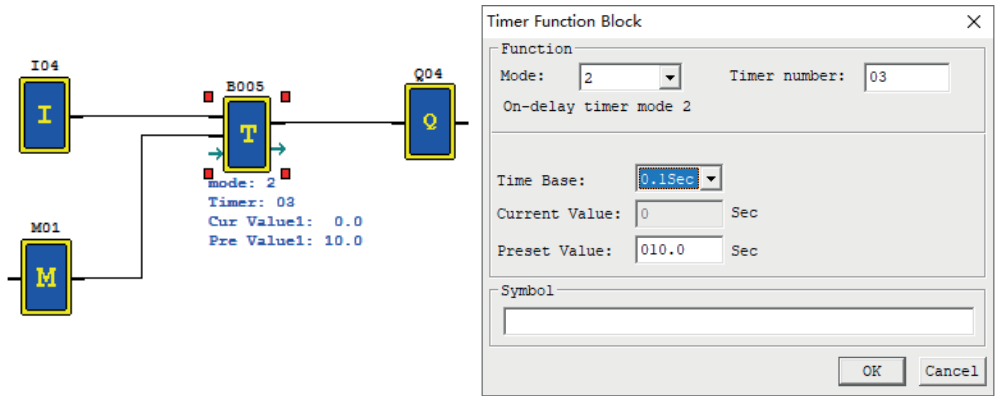

TIMER MODE 3 (OFF-DELAY A MODE)

Timer mode 3 is designed with reset control. T output is ON but the timer does not work when the control condition turns from OFF to ON; timer is started up for timing when the control condition turns ON to OFF; timing is stopped, the current value is reset as 0 and T output is OFF when the current value of timer reaches the preset value; the current value and coil status are reset to 0 when reset control is effective.

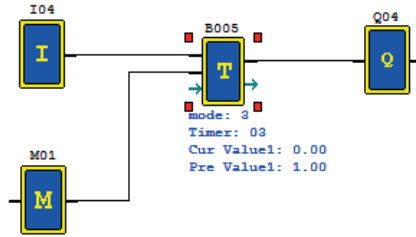

Timer Function Block X

Function
 Mode: 3 Timer number: 03

Off-delay timer mode 1

Time Base: 0.01Sec

Current Value: 0 Sec

Preset Value: 01.00 Sec

Symbol

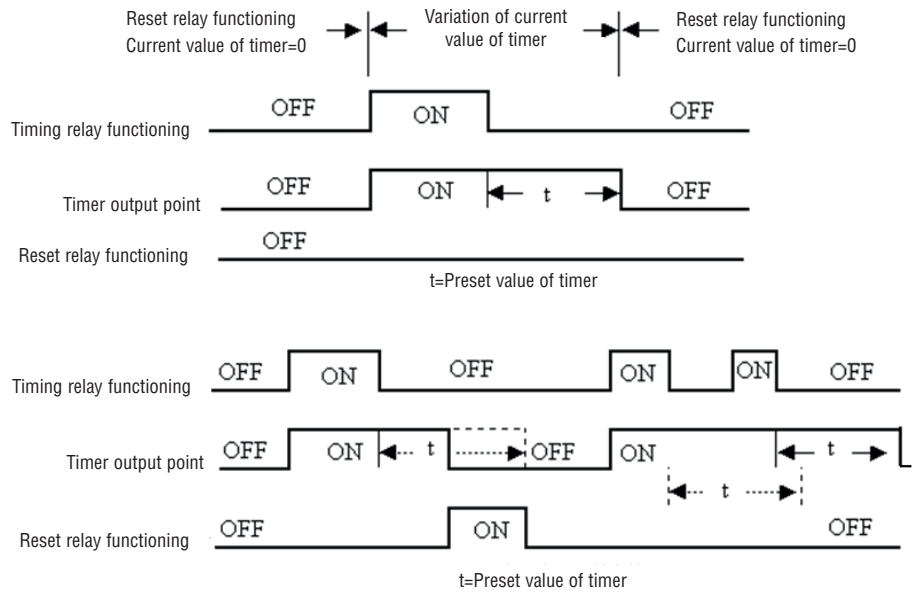
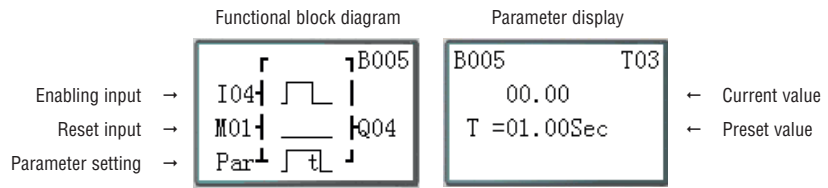

TIMER MODE 4(OFF-DELAY B MODE)

Timer mode 4 is designed with reset control. Timing is started and T output is ON when the control condition turns from ON to OFF; timing is stopped, the current value is reset and T output is OFF when the current value of timer reaches the preset value; the current value of timer and coil status are reset to 0 when reset control is effective.

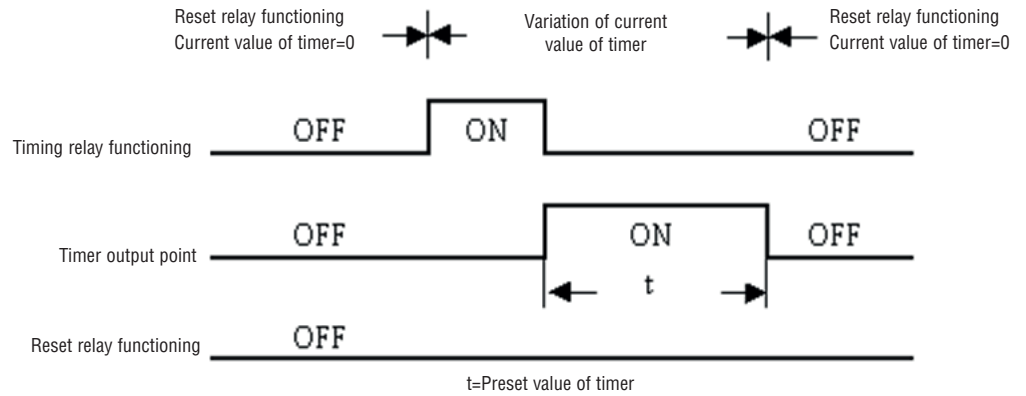
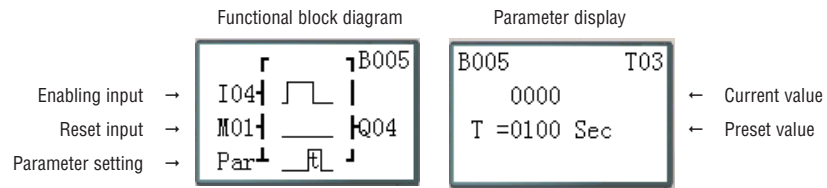
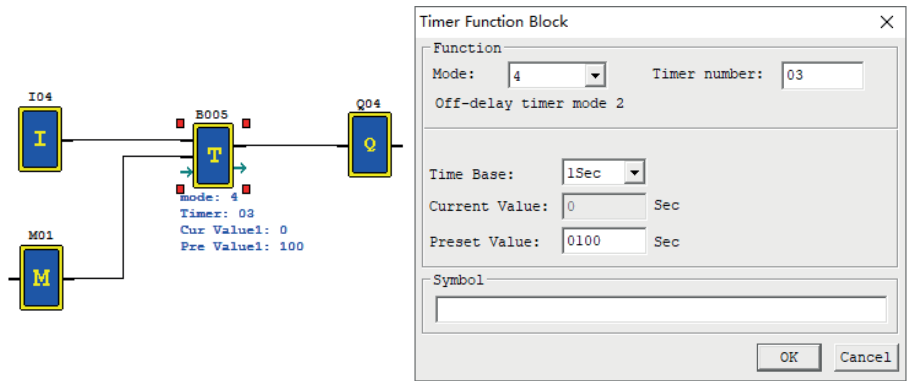

TIMER MODE 5(FLASH A MODE)

Timer mode 5 is a flash output mode without reset control. The timer begins timing when the control condition is effective; status of output coil T is shifted when the current value of timer reaches the preset value; timing is continued when the current value is reset to 0.

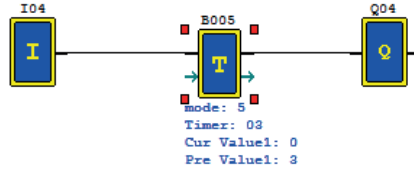

Timer Function Block ✕

Function

Mode: Timer number:

Flash timer mode 1

Time Base:

Current Value: Sec

Preset Value: Sec

Symbol

Functional block diagram

Parameter display

B005	T03
0000	
T =0003 Min	

← Current value

← Preset value

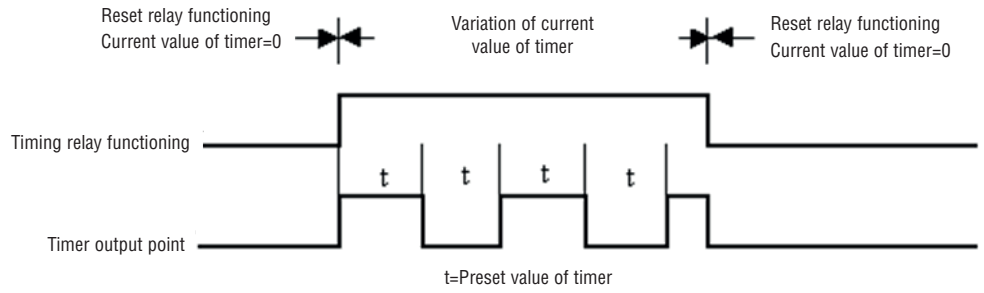

TIMER MODE 6 (FLASH B MODE)

Timer mode 6 is a flash output mode with reset control. The timer begins timing when the control condition turns from OFF to ON, status of output coil is shifted when the preset value is reached, and timing is continued when the current value of timer is reset to 0. In mode 6, the control condition is not required to be kept ON, and the current value of timer and output coil are reset to 0 when reset control is effective.

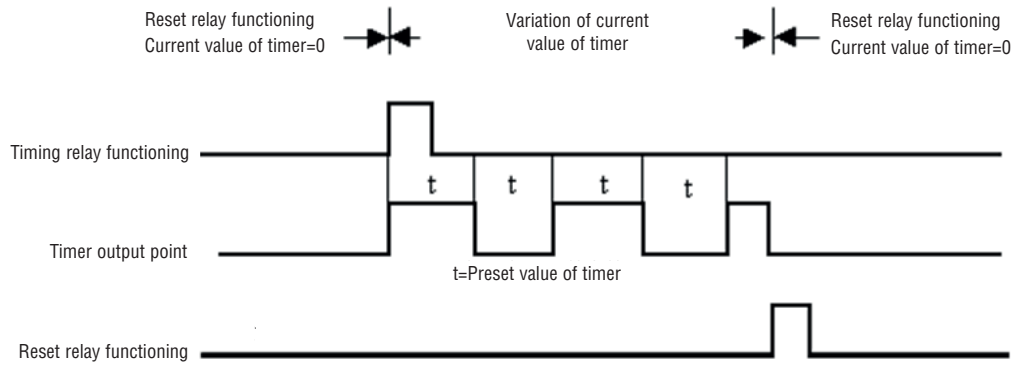
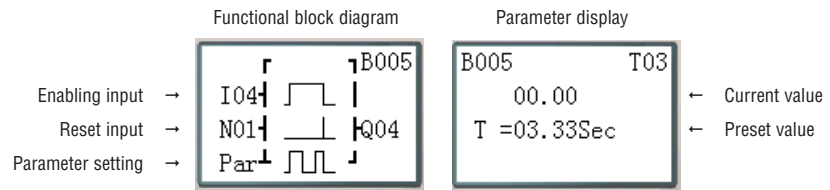
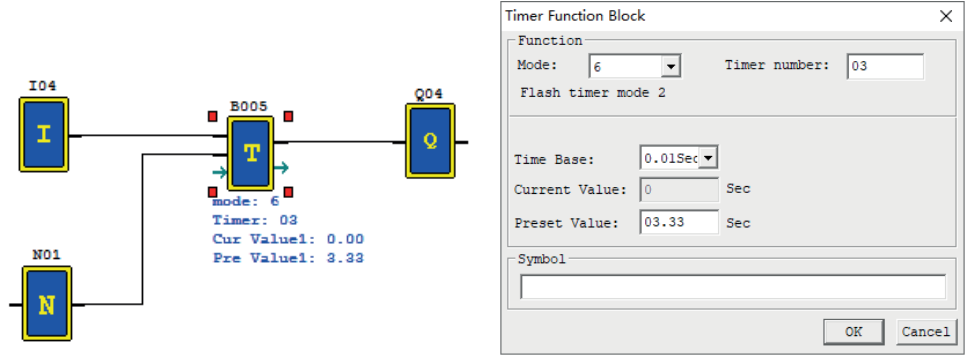

TIMER MODE 7 (FLASH C MODE)

Timer mode 7 is a pulse output timer without reset control, which uses two timers T1 and T2. T1 begins timing and T1 outputs ON when the control condition turns from OFF to ON; timing is stopped, the current value of T1 is kept, T1 outputs OFF and T2 is started up when the current value of T1 reaches the preset value; timing is stopped and T2 outputs ON when the current value of T2 reaches its preset value; T1 is restarted when the rising edge of T2 resets T1 and T2, namely the current value of T1 is reset as 0 and the current value of T2 and T2 coil are reset as 0.

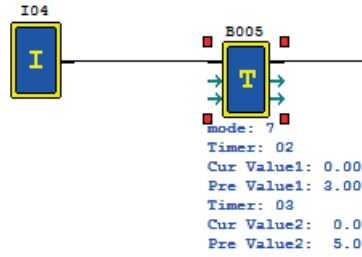

Timer Function Block

Function

Mode: Timer number:

Flash timer mode 3

	Ton	Toff
Time Base:	<input type="text" value="0.01Sec"/>	<input type="text" value="0.1Sec"/>
Current Value:	<input type="text" value="0"/> Sec	<input type="text" value="0"/> Sec
Preset Value:	<input type="text" value="03.00"/> Sec	<input type="text" value="005.0"/> Sec

Symbol

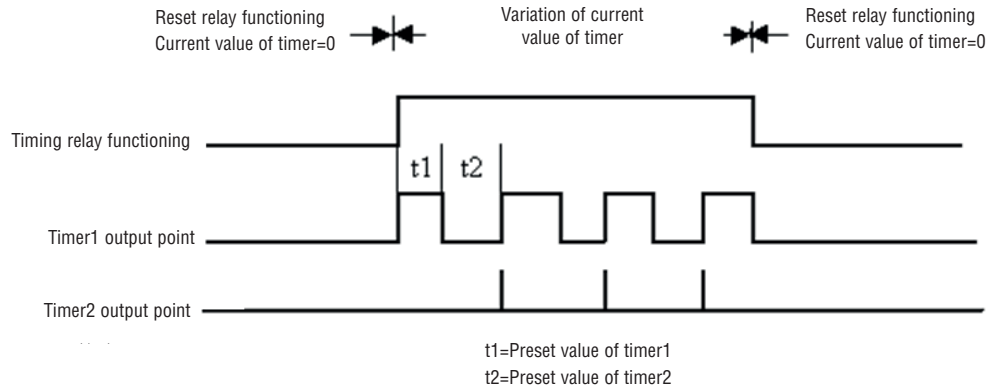
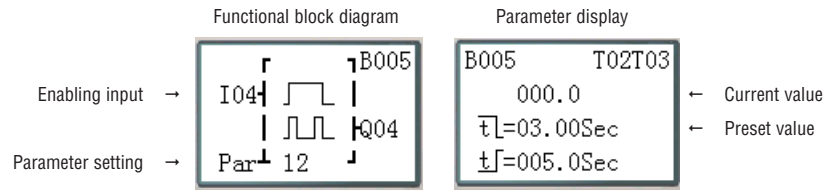

TIMER MODE 8

Timer mode 8 is a stopwatch mode with reset control and pause control. The timer begins timing when the control condition turns from OFF to ON; status of output coil is shifted, the current value of timer is displayed as the preset value and timing is discontinued when the preset value is reached; the current value of timer and output coil are reset to 0 when reset control is effective.

The current value is not updated (timing continued) when Pause input is set ON; the current value is updated (to current actual value) when Pause input is OFF; the current value is displayed as 9999 and timing is discontinued when Pause input is ON and actual value is the preset value.

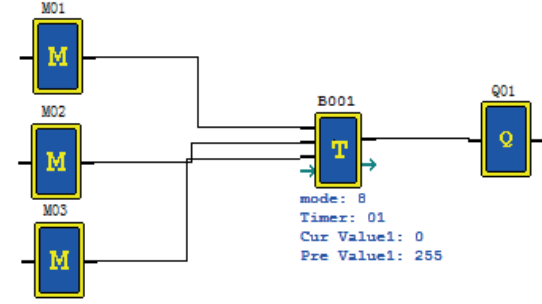
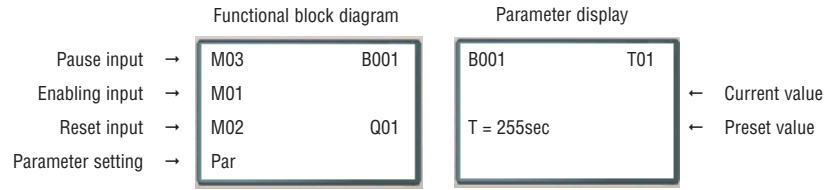

Timer Function Block [X]

Function

Mode: 8 Timer number: 01

Stopwatch

Time Base: 1Sec

Current Value: 0 Sec

Preset Value: 0020 Sec

Symbol

OK Cancel

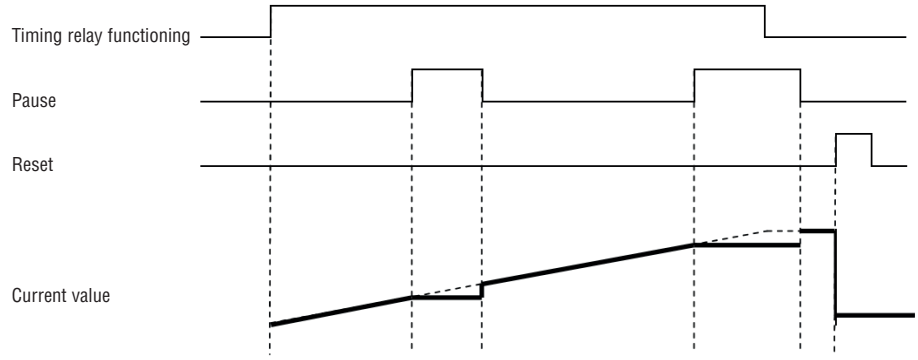

GENERAL COUNTER FUNCTIONAL BLOCK DIAGRAM

The maximum number of counters used under FBD is 250. Modes 0-6 are general counter, and modes 7-9 are high-speed counter; the counter function is the same with that under Ladder.

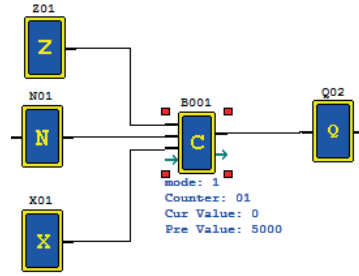

Counter editing and display:

FBD display:

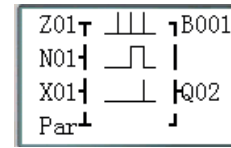

Parameter display:

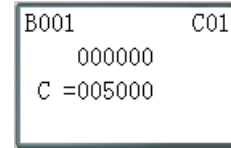

Counter Function Block

Function

Mode: 1 Counter number: 01

Counter without overtaking and without power down retain current value

Current Value: 0

Preset Value: 005000

Fixed Time (Sec):

Upper:

Lower:

Symbol

OK Cancel

* The following modes are described based on counting up. Counting down is counting of input rising edge from the preset value (not kept) or the current value (kept); the current value is decreased by 1, and counting is stopped when the current value is 0; when it is reset, the current value is equal to the preset value.

(1) Counter mode 0 (internal coil)

Used as internal auxiliary coil, counter of mode 0 does not have a reset value and parameter display.

Functional block diagram

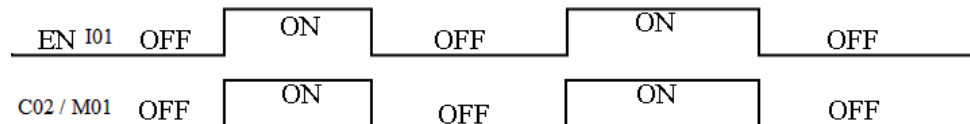
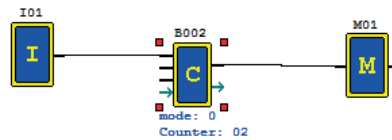
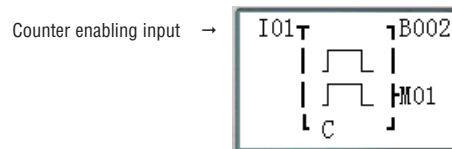

COUNTER MODE 1 (OVERFLOW NOT ALLOWED, NOT KEPT)

The current value of counter is counted up from 0, counting is stopped and output coil is ON when the preset value is reached. In case of power failure, the current value is not kept after power-on again or RUN/STOP switching.

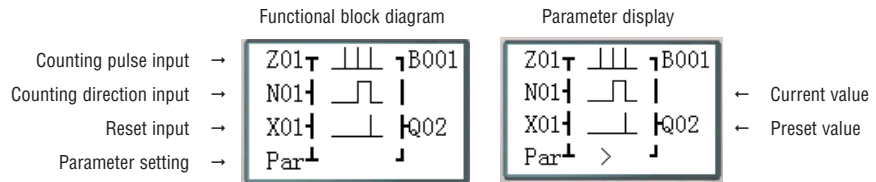
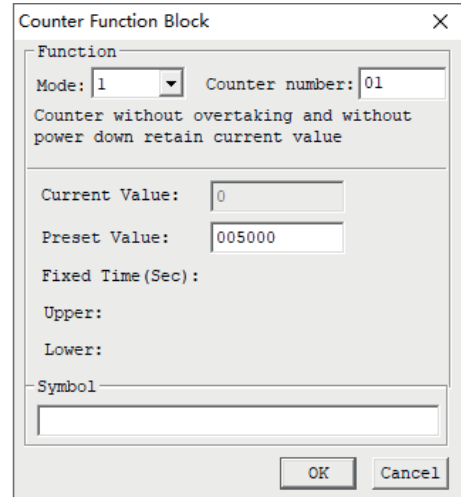
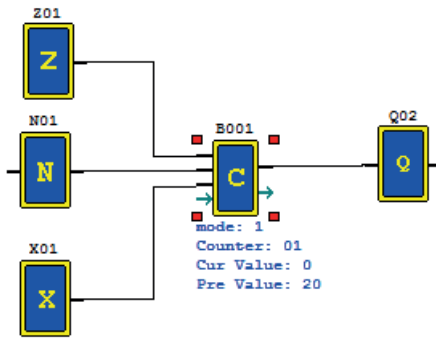

Mode=1

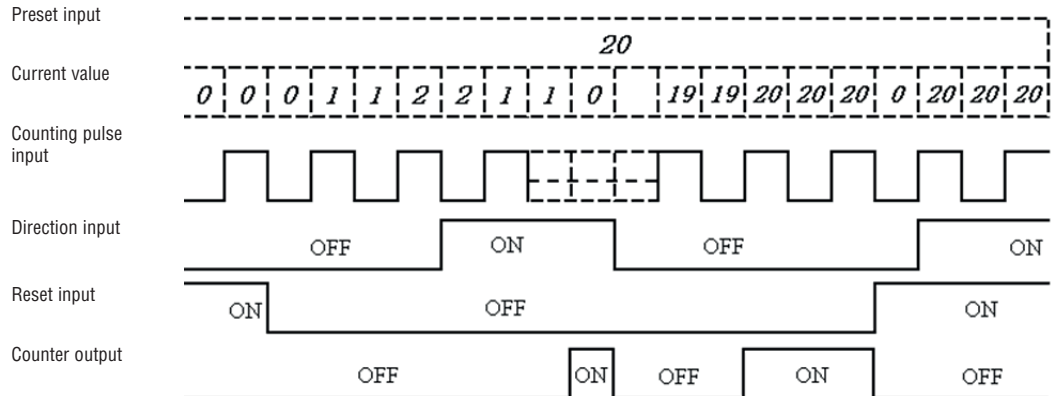

* In this mode, the current value of counter is initialized to 0 (counting up) or the preset value (counting down) after power-on or RUN/STOP switching; the current value is 0 (counting up) or the preset value (counting down) after resetting.

COUNTER MODE 2 (OVERFLOW ALLOWED, NOT KEPT)

The current value of counter is counted up from 0; after the preset value is reached, output coil is ON, but counting of input rising edge is continued till the current value is 65535. After power-on or RUN/STOP switching, the current value of counter is not kept.

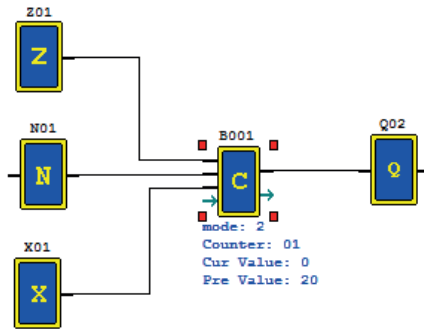

Counter Function Block

Function

Mode: Counter number:

Counter with overtaking and without power down retain current value

Current Value:

Preset Value:

Fixed Time (Sec):

Upper:

Lower:

Symbol

OK Cancel

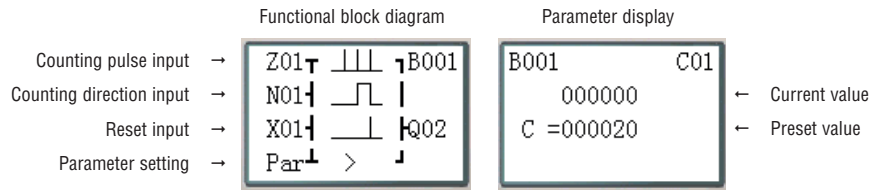

* ">": Counter allowing overflow.

Mode=2

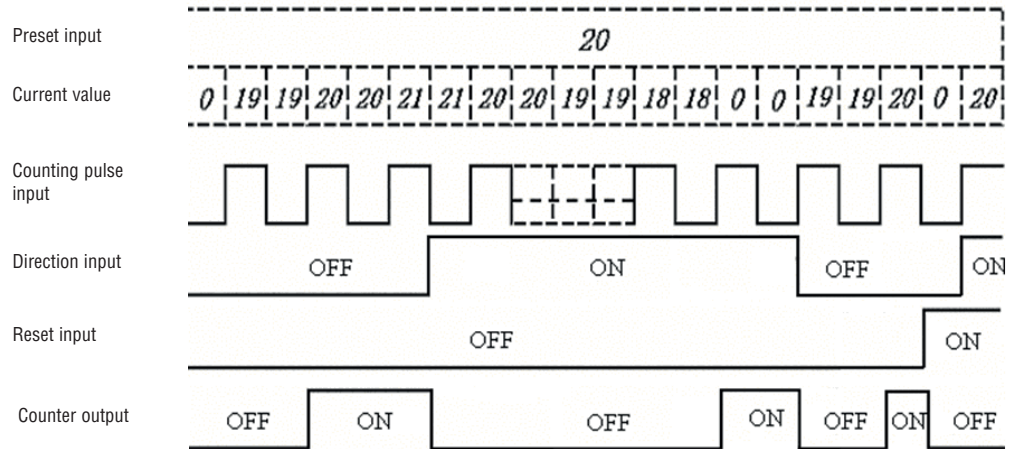

* In this mode, the current value of counter increases continuously after the preset value is reached, and initialized to 0 (counting up) or the preset value (counting down) after power-on or RUN/STOP switching. After resetting, the current value is 0 (counting up) or the preset value (counting down).

COUNTER MODE 3 (OVERFLOW NOT ALLOWED, KEPT)

The counter mode 3 is similar to mode 1, namely counting is stopped and output coil is ON when the current value reaches the preset value, but the current value is kept after power-on again. If "C KEEP" is effective, the current value is kept after RUN/STOP switching.

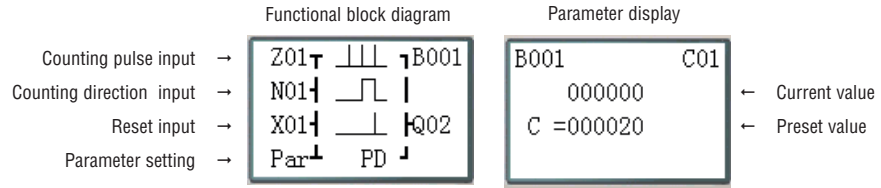

- * "PD": The current value is kept in case of power failure.
- * Mode 3 is similar to mode 1, but the current value of the first 31 counters (C01~C1F) is kept in case of power failure.
- * If C KEEP is set, the current value is kept after RUN/STOP switching.
- * The current value is 0 (counting up) or the preset value (counting down) when resetting.

(5) COUNTER MODE 4 (OVERFLOW ALLOWED, KEPT)

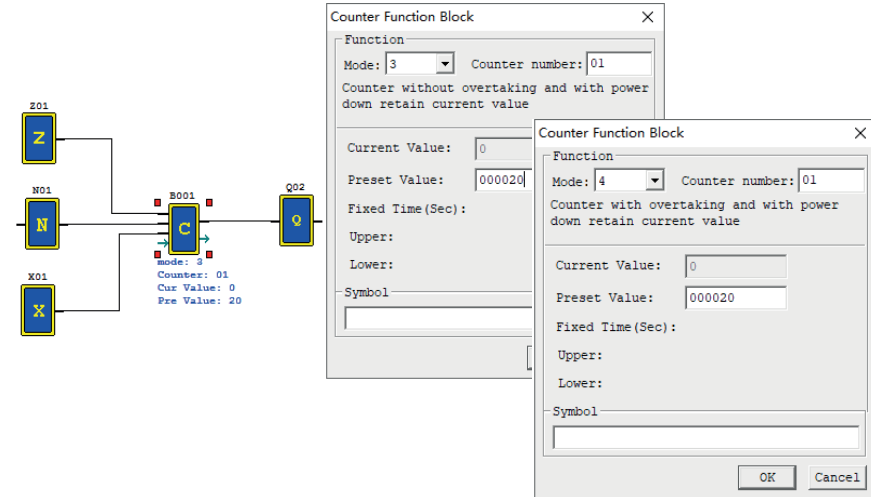

The counter mode 4 is similar to mode 2, namely counting is continued after the current value reaches the preset value, but the current value is kept after power failure. If C KEEP is set, the current value is kept after RUN/STOP switching.

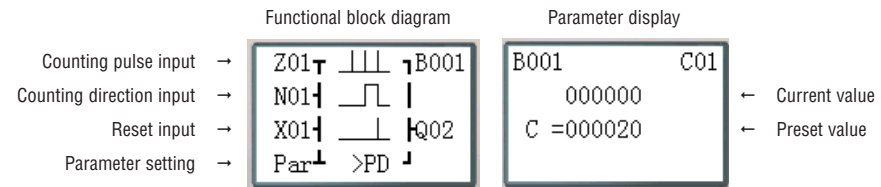

- * ">": Counter allowing overflow;
- * "PD": The current value is kept in case of power failure.
- * Mode 4 is similar to mode 2, namely counting continues after the current value reaches the preset value, but the current value of the first 31 counters (C01~C1F) is kept after power failure.
- * If C KEEP is set, the current value is kept after RUN/STOP switching.
- * The current value is 0 (counting up) or the preset value (counting down) when resetting.

COUNTER MODE 5 (OVERFLOW ALLOWED, NOT KEPT, COMPARISON COUNTER)

The counter mode 5 is similar to mode 2, namely counting overflow is allowed, but the current value is not kept after power-on again or RUN/STOP switching. Regardless of counting direction in mode 5, output is ON only when the current value is higher than or equal to the preset value, and the current value is 0 after resetting, power failure or RUN/STOP switching.

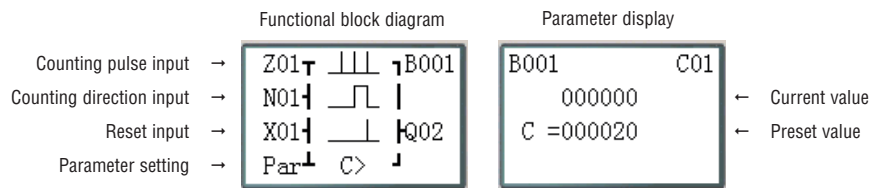
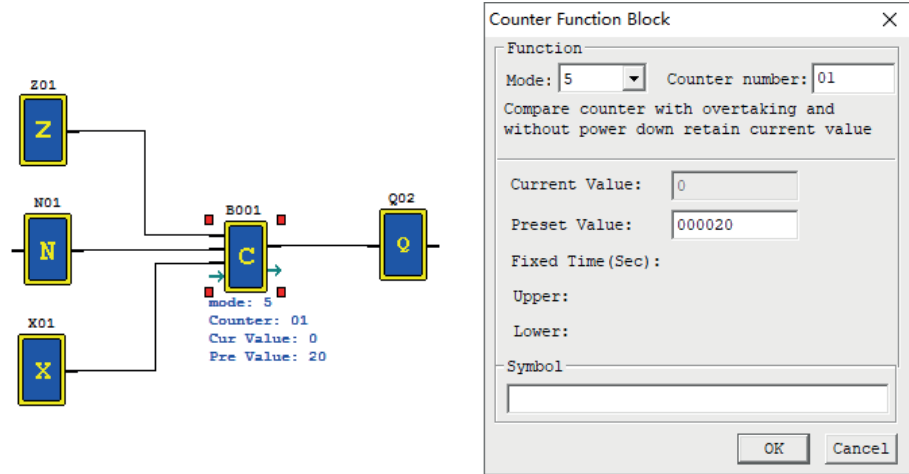

* "C": Comparison counter;
 ">": Counter allowing overflow.

Mode=5

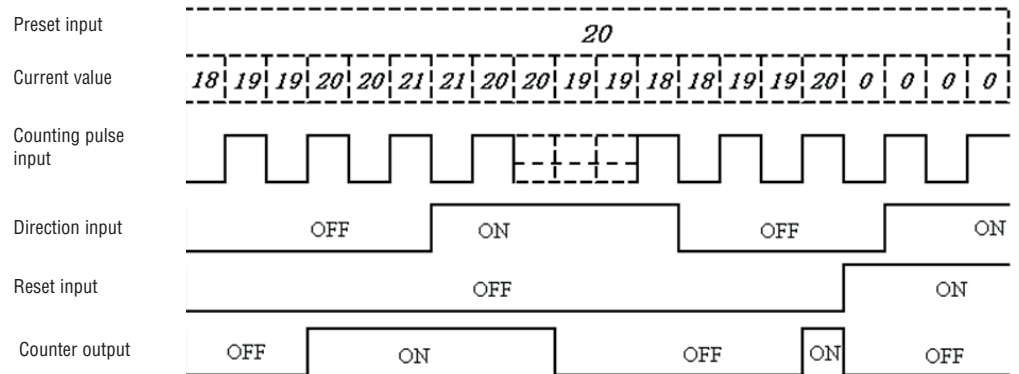

* In this mode, counting continues after the current value of counter reaches the preset value; regardless of counting direction, the current value is 0 after resetting, and not kept after power-on again or RUN/STOP switching.

COUNTER MODE 6 (OVERFLOW ALLOWED, KEPT, COMPARISON COUNTER)

The counter mode 6 is similar to mode 5, but the current value is kept in case of power failure; if C KEEP is set, the current value is kept after RUN/STOP switching.

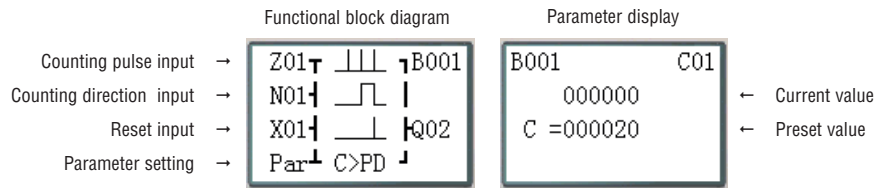
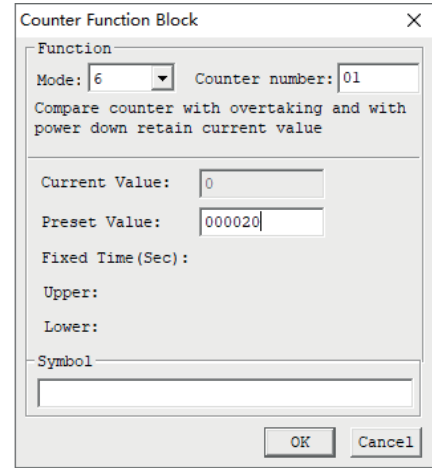
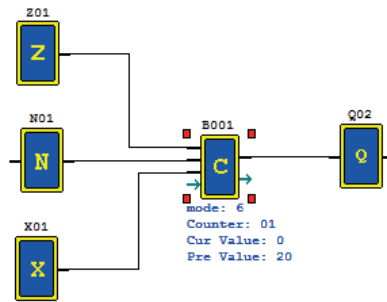

- * "C": Comparison counter;
- ">": Counter allowing overflow;
- "PD": The current value is kept in case of power failure.
- * The current value of the first 31 counters (C01~C1F) is kept after power failure.
- * If C KEEP is effective, the current value is kept after RUN/STOP switching.

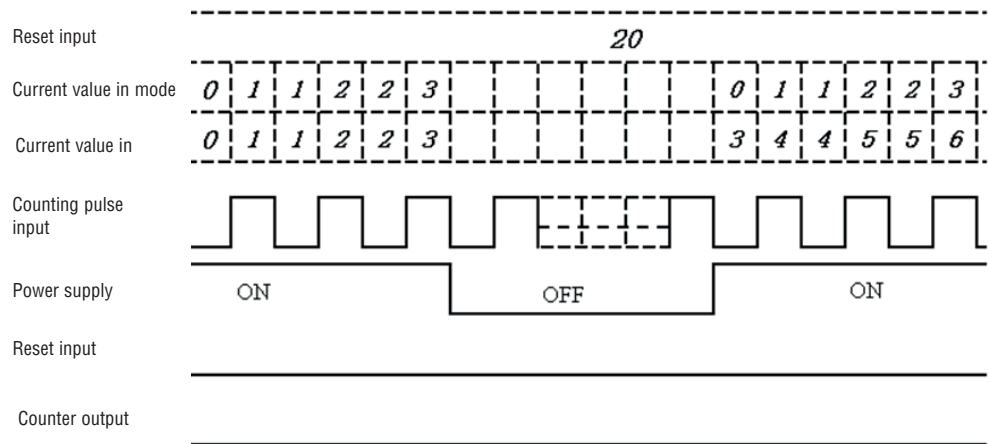

HIGH-SPEED COUNTER FUNCTIONAL BLOCK DIAGRAM (FOR DC TYPE ONLY)

LRK with DC power supply provides two 1KHz high-speed inputs I01 and I02, and uses two counters to realize two groups of high-speed counting. Counter modes 7-9 are high-speed counting function.

(1) High-speed counter mode 7 (proportional input counter)

In DC machine, high-speed counter mode 7 uses I01 or I02 as the maximum 1KHz high-speed input, and counting is stopped and output coil is ON after the counting value reaches the preset value. After resetting, the current value of counter is reset to 0 and output coil is OFF.

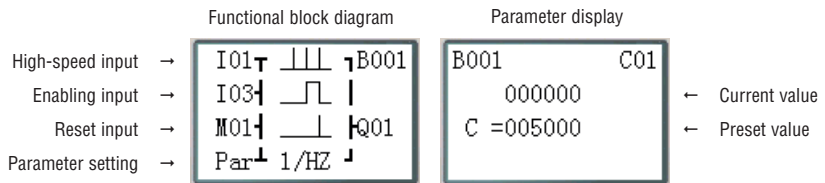
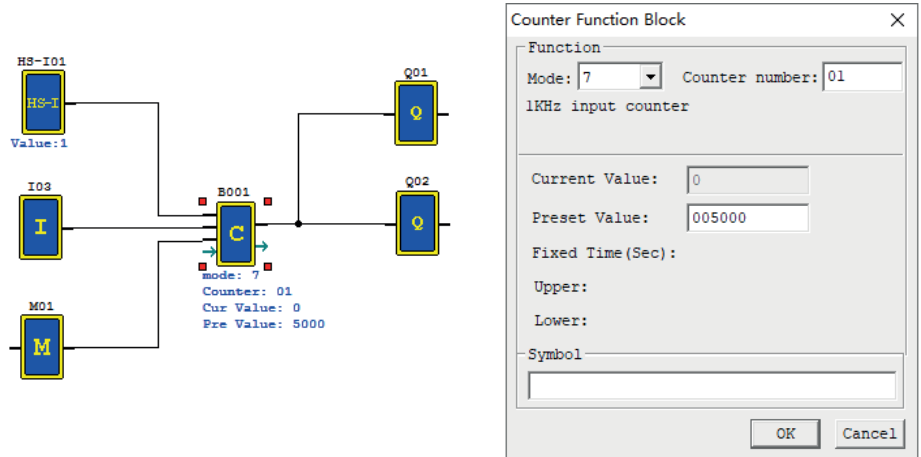

* High-speed input port: I01 or I02.

Output example:

In the above example, Q01 outputs ON immediately when C01(B001) counting value reaches the preset value, and Q02 outputs ON only when output is executed in the scanning cycle.

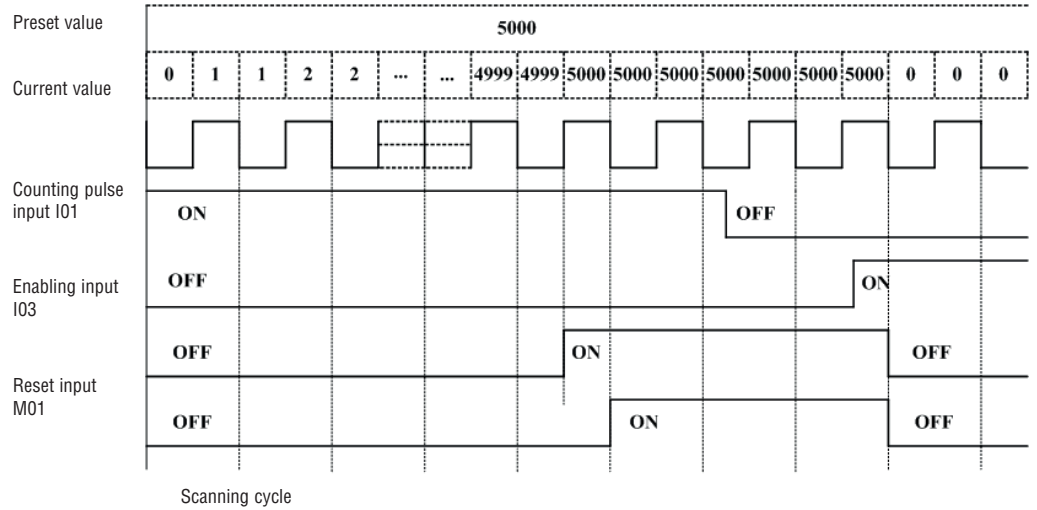

HIGH-SPEED COUNTER MODE 8 (1KHZ INPUT COUNTER)

In high-speed counter mode 8, I01 or I02 is used as the maximum 1KHz high-speed input port. Output coil is ON if the number of rising edges counted in the set time interval is more than or equal to the ON preset value; on the contrary, output coil is OFF if the counted number of rising edge is less than the OFF preset value; the output status is kept under other conditions.

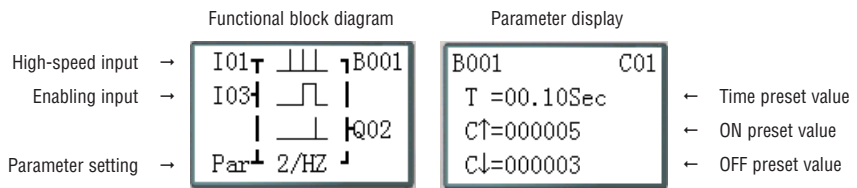
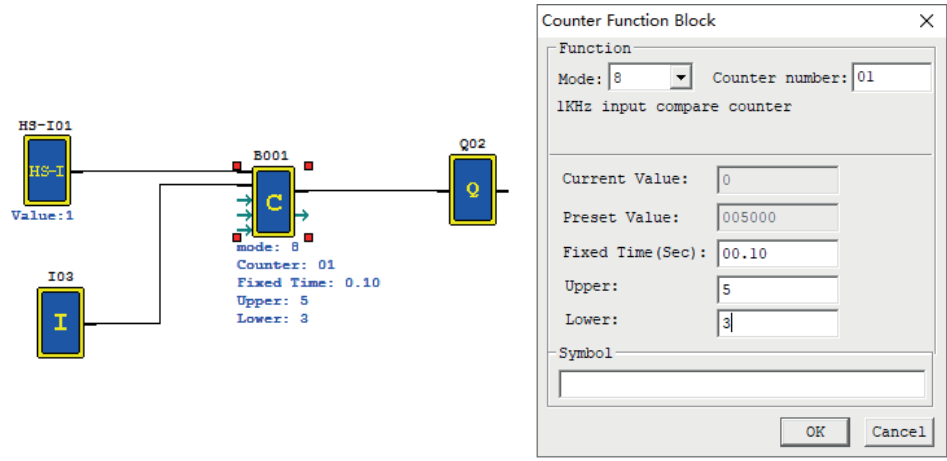

* High-speed input port: I01 or I02.

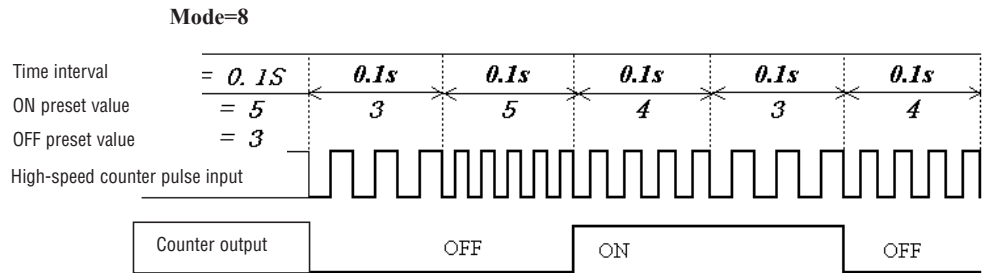

HIGH-SPEED COUNTER MODE 9 (1KHZ INPUT AB PHASE COUNTER)

Mode 9 is AB-phase high-speed counting function for counting of two lines of pulse with consistent periodic pulse width and phase difference of 90°, which uses the same editing method with general high-speed counting but has different parameters.

In DC machine, high-speed counter mode 9 enables high-speed input counting of the maximum 1KHz AB phases of I01 (A) ahead of I02 (B); the current value of counter is (0-999999), output coil is ON when the counting value reaches the preset value; the current value of counter is reset to 0 and output coil is OFF after resetting.

As a special coil, the coil M3A indicates the counting direction of AB phase counter; M3A is set OFF when phase A is ahead of phase B, or set ON when phase A is behind phase B.

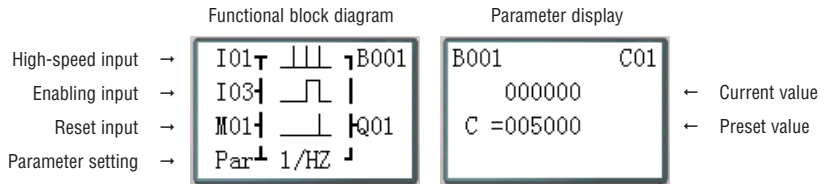
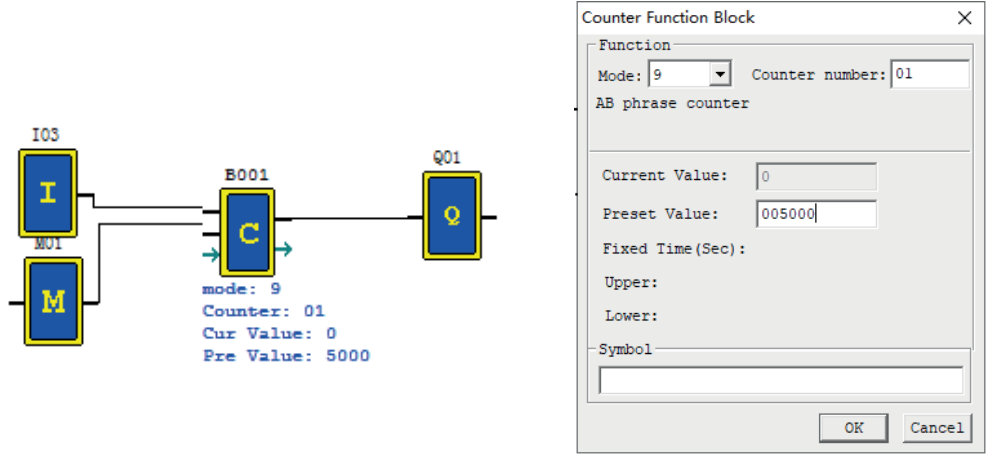

* High-speed input port: I01 (A) and I02 (B).

RTC FUNCTIONAL BLOCK DIAGRAM

The maximum number of RTC functional blocks used under FBD is 250. RTC works in modes 0-5, and its function is the same with that under Ladder.

RTC MODE 0 (INTERNAL COIL)

RTC of mode 0 is used as internal coil, which does not have preset value and parameter display.

Functional block diagram

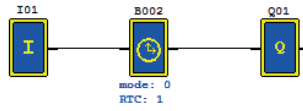
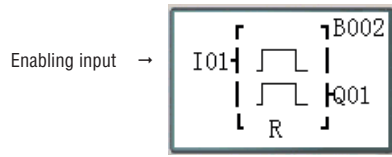

RTC MODE 1 (DAY MODE)

RTC mode 1 is for setting the daily ON/OFF time of each week.

In the following example (1), effective time of each week is set as MO (Monday) 8:00 to FR (Friday) 17:00, namely coil B002 (R01) outputs ON from 8:00 to 17:00 in Monday to Friday, and outputs OFF at other times.

Example 1:

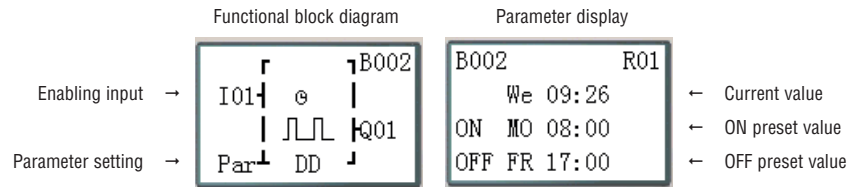
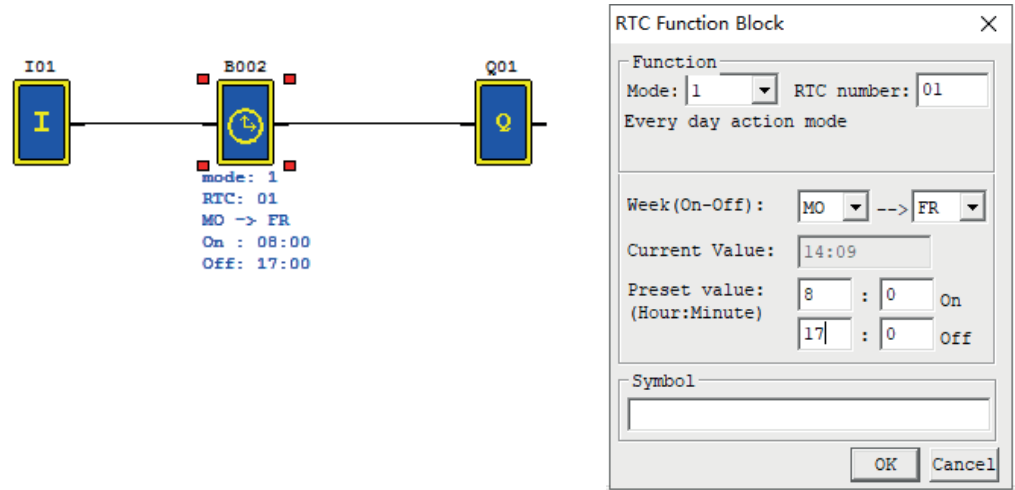

- * The displayed current time is week- hour- minute.
- * The displayed ON/OFF preset value is week- hour- minute.

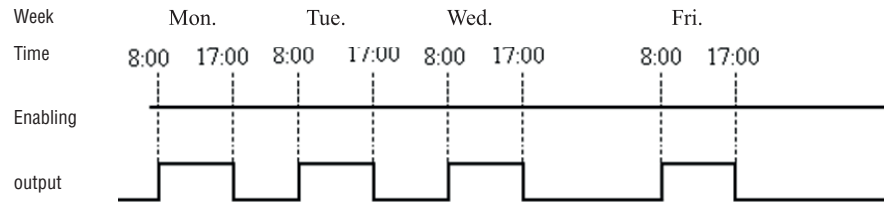

Example 2:

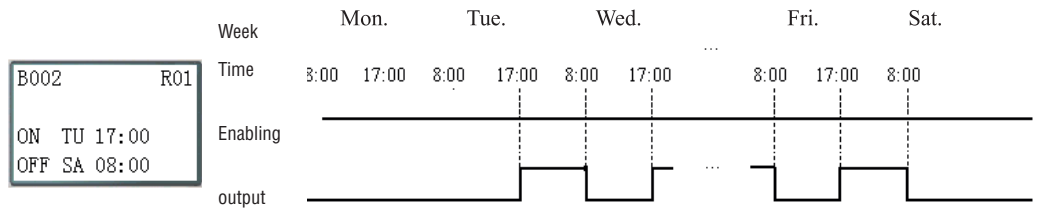

RTC MODE 2 (WEEK MODE)

RTC mode 2 is for setting ON/OFF time of coil R in a week. In the following example (1), coil B002 (R01) outputs ON from TU (Tuesday) 8:00 to SA (Saturday) 17:00, and outputs OFF at other times.

Example 1:

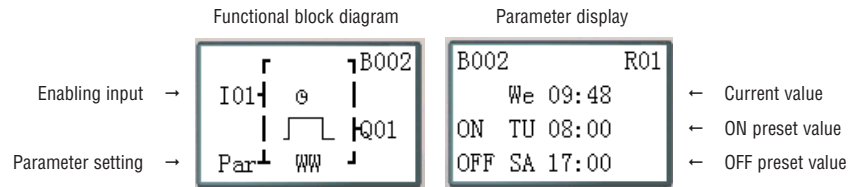
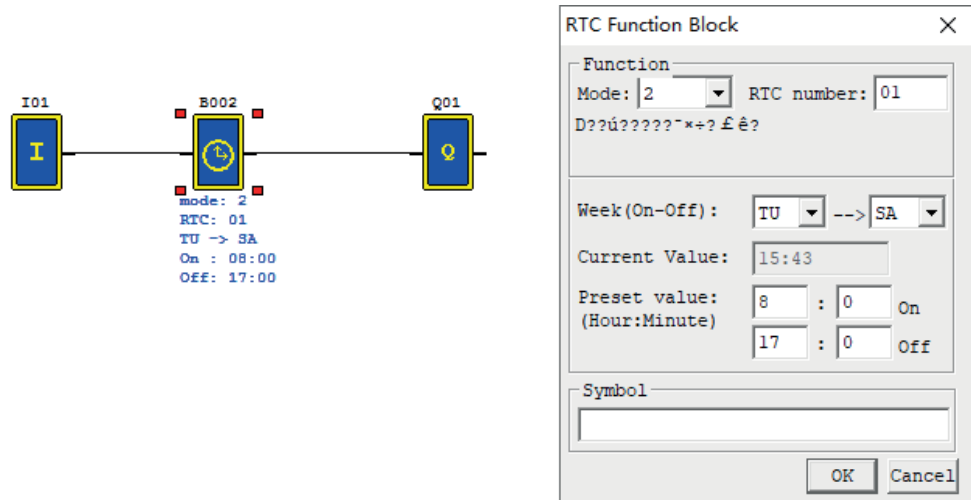

- * The displayed current time is week- hour- minute.
- * The displayed ON/OFF preset value is week- hour- minute.

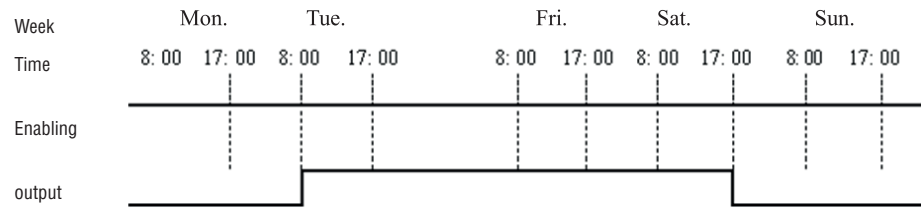

Example 2:

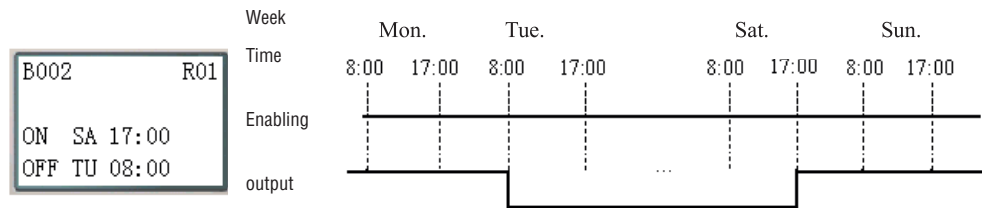

RTC MODE 3 (YEAR-MONTH-DAY MODE)

RTC mode 3 uses the set year-month-day to control status of coil R. In example 1, coil outputs ON from February 17, 2009 to November 11, 2010.

When the year setting is 00-00 in RTC mode3, a special mode is used to enable RTC from the beginning month and day to the end month and day of each year, as shown in example 3.

Example 1:

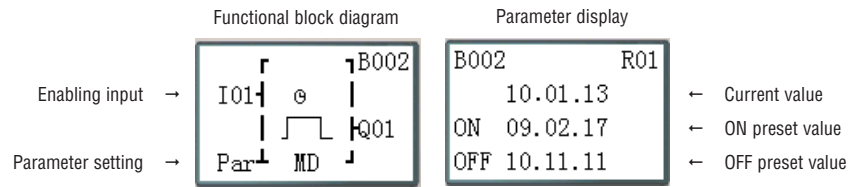
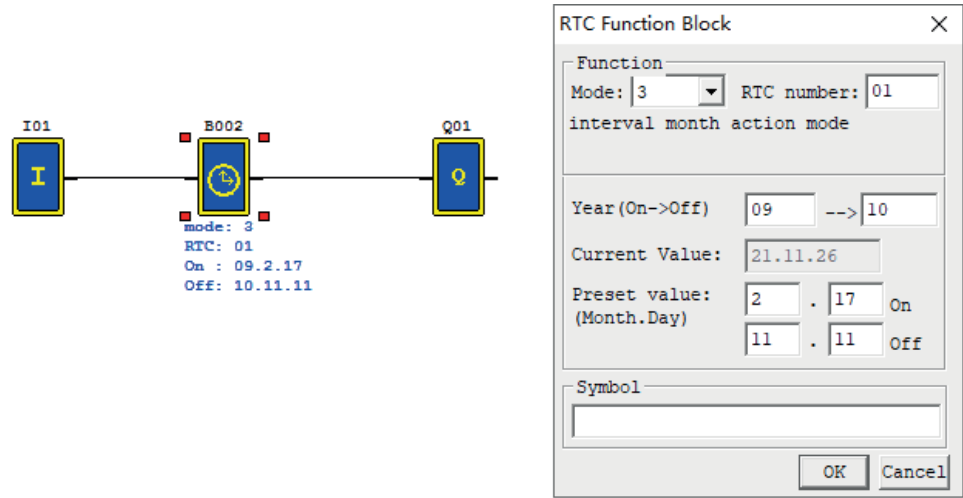

- * The displayed current time is year- month-day.
- * The displayed ON/OFF preset value is year- month-day.

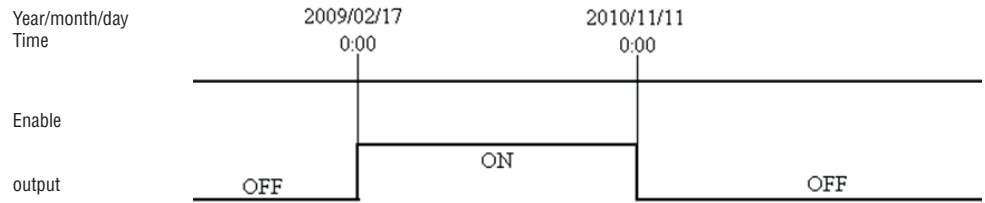

Example 2:

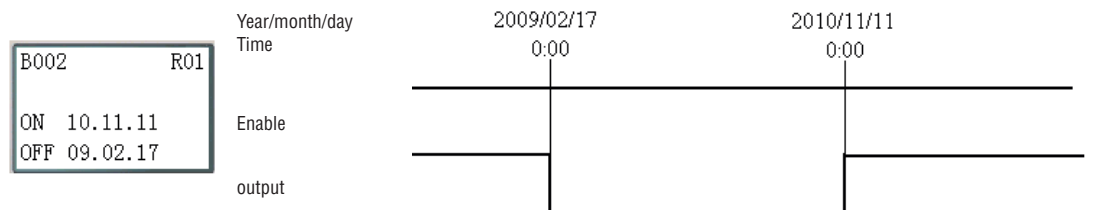

Example 3:

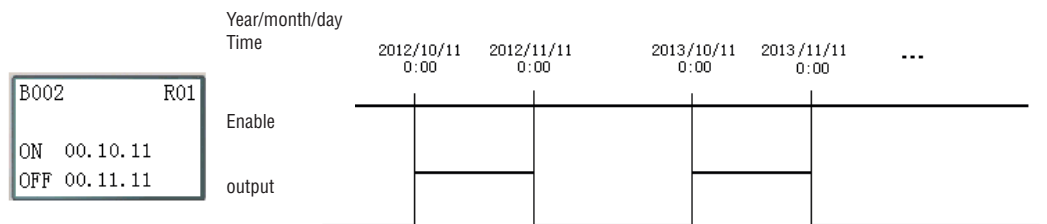

RTC MODE 4 (30S COMPENSATION)

RTC mode 4 is a 30s compensation mode, which uses the set week, hour, minute and second for operation of the current value of RTC and correction of RTC error.

Example 1:

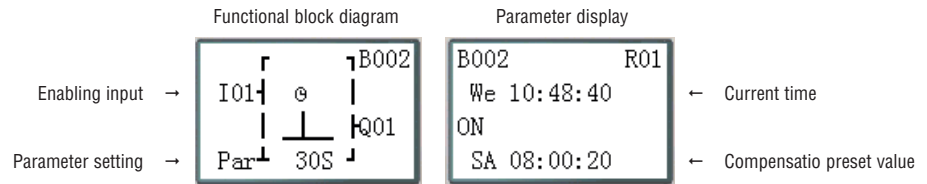
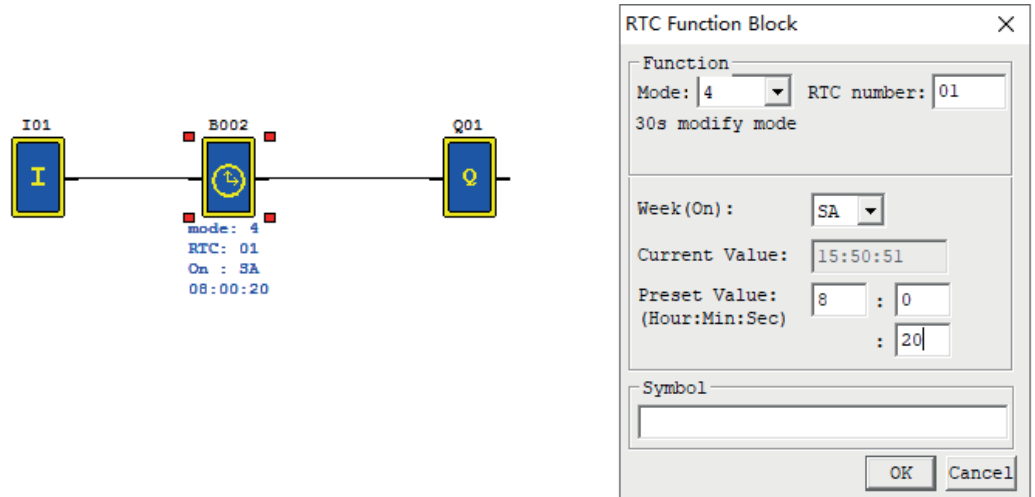

- * The displayed current time is week-hour-minute-second.
- * The displayed compensation preset value is week-hour-minute-second.

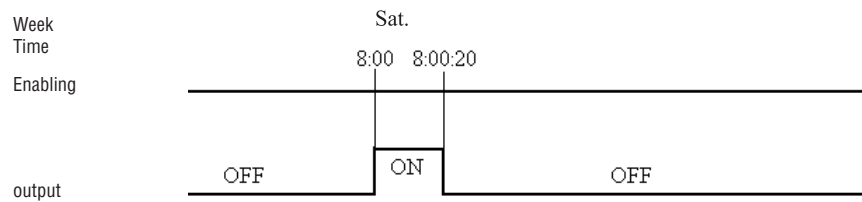

- * When RTC time is 8:00:20, the current time returns to 8:00:00 for continuous timing, and coil outputs ON. When RTC time reaches 8:00:20 again, coil outputs OFF and RTC continues timing. So, the duration when coil outputs ON is 21s.

Example 2: Corrected second >= 30s

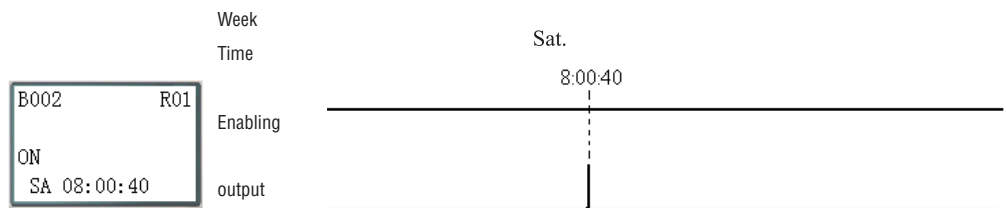

- * R01 outputs ON when the current value of RTC is 8:00:40, and outputs OFF when RTC time changes to 8:01:00. The duration when outputs ON is a scanning cycle only.

RTC MODE 5 (ASTRONOMICAL CLOCK)

RTC mode 5 is the astronomical clock mode that uses the set longitude and latitude and offset time to control output of RTC coil. The display form and parameter meaning of RTC mode 5 and programming interface under Ladder are provided in the following diagram and table.

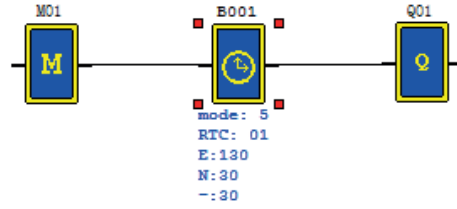

RTC Function Block ✕

Function

Mode: RTC number:

Sunset mode

E/W: E W

longitude: (0~180)

S/N: S N

latitude: (0~90)

?a +

Offset time (min): (0~59)

Symbol

After the corresponding parameter, E/W (east/west longitude) and longitude value, S/N (south/north latitude) and latitude value are set, the functional block R will work out the sunrise time and sunset time in the set place in the current season and enable the setting of forward (-) or backward (+) offset time (0~59min) of sunrise/sunset time by setting the offset direction, and coil R will output ON from sunrise to sunset and output OFF at other times.

- * Sunrise/sunset time is computed based on the current value of RTC, and R01 is set ON from sunrise to sunset.
- * DRCE and DRCF are special registers where longitude and latitude based sunrise, sunset and time are stored.

ANALOG COMPARATOR FUNCTIONAL BLOCK DIAGRAM

The maximum number of analog comparator functional blocks used under FBD is 250. Analog comparator works in modes 0~7, and its function is the same with that under Ladder.

ANALOG COMPARATOR MODE 0 (INTERNAL COIL)

Analog comparator of mode 0 is used as internal auxiliary coil, which does not have preset value and parameter display.

Functional block diagram

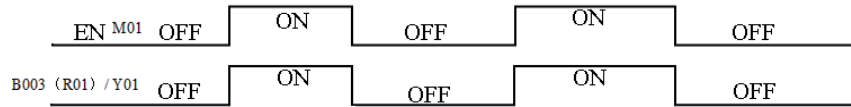
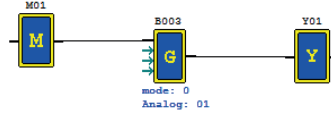
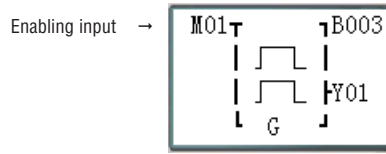

ANALOG COMPARATOR MODE 1~7

The set parameters of analog comparator include analog input Ax, analog input Ay and comparison reference value. The relations are as follows:
 Comparator mode 1: $(Ay - \text{comparison reference value}) \leq Ax \leq (Ay + \text{comparison reference value})$, output ON;
 Comparator mode 2: $Ax \leq Ay$, output ON;
 Comparator mode 3: $Ax \geq Ay$, output ON;
 Comparator mode 4: comparison reference value $\geq Ax$, output ON; Comparator mode 5: comparison reference value $\leq Ax$, output ON; Comparator mode 6: comparison reference value $= Ax$, output ON; Comparator mode 7: comparison reference value $\neq Ax$, output ON.

Example of program setting interface:

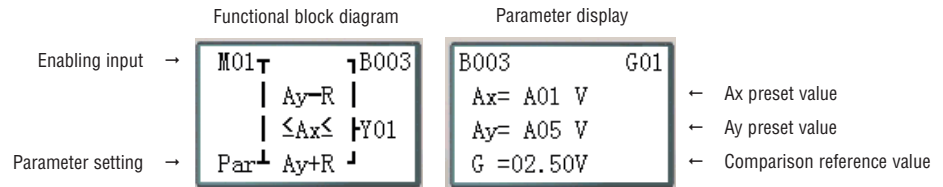
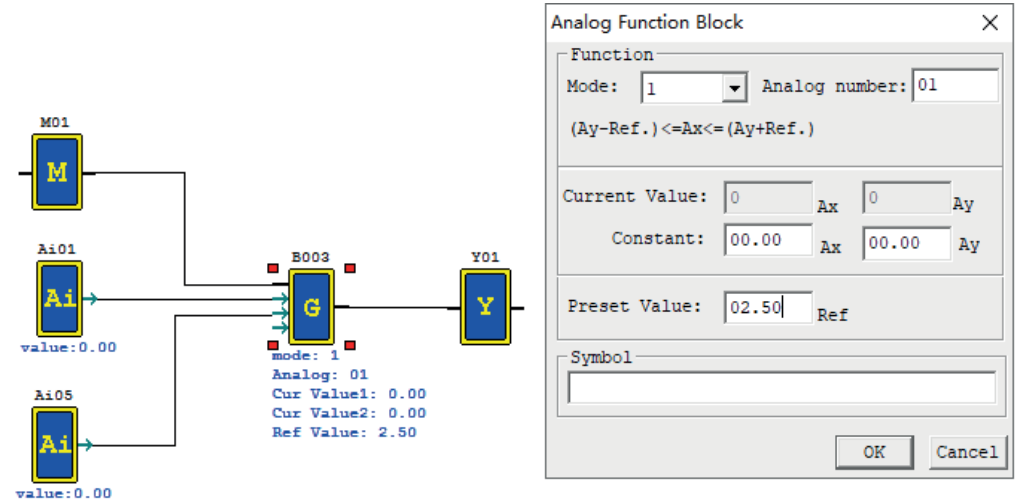

B003 (G01) outputs ON when A01 value is in the range $(A05 - 2.50) \sim (A05 + 2.50)$. The current values of Ax and Ay are displayed in the RUN mode.

Comparator mode 2

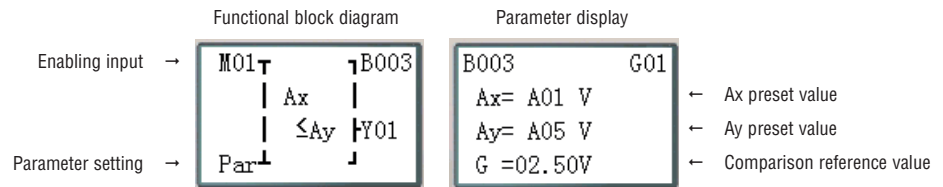

B003 (G01) outputs ON when A01 value is not more than A05 value. The current values of Ax and Ay are displayed in the RUN mode.

Comparator mode 3

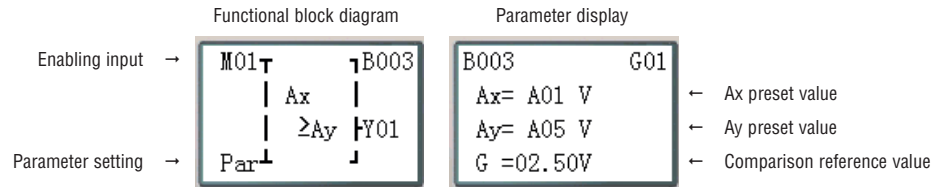

B003 (G01) outputs ON when A01 value is not less than A05 value. The current values of Ax and Ay are displayed in the RUN mode.

Comparator mode 4

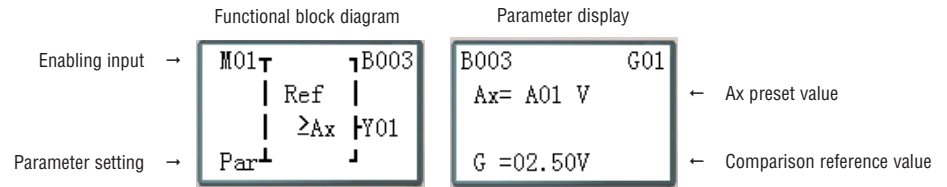

B003 (G01) outputs ON when A01 value is not more than 2.50.
The current value of Ax is displayed in the RUN mode.

Comparator mode 5

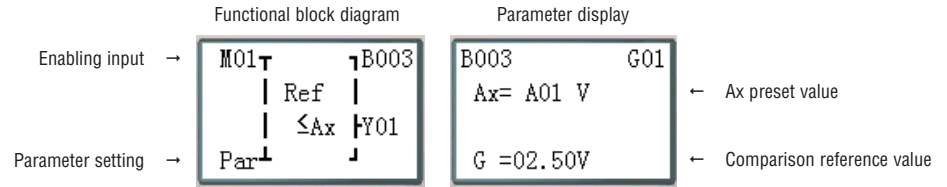

B003 (G01) outputs ON when A01 value is not less than 2.50.
The current value of Ax is displayed in the RUN mode.

Comparator mode 6

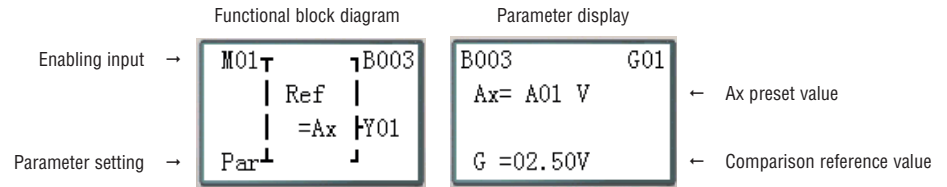

B003 (G01) outputs ON when A01 value is equal to 2.50.
The current value of Ax is displayed in the RUN mode.

Comparator mode 7

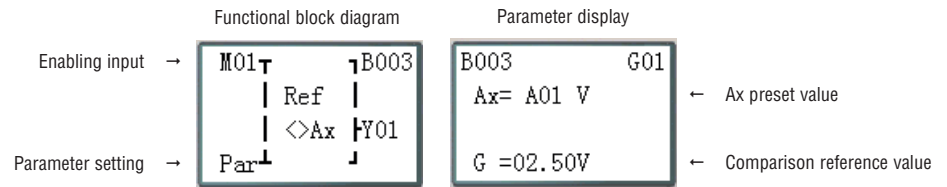

B003 (G01) outputs ON when A01 value is not 2.50.
The current value of Ax is displayed in the RUN mode.

FILTER FUNCTIONAL BLOCK DIAGRAM

The maximum number of filter functional blocks used under FBD is 250. Filter works in mode 0-4 and its function is the same as under Ladder.

FILTER MODE 1: ANALOG FILTER

Function description: Analog filter function is started after parameters are configured and status of the enabled coil turns from 0 to 1. This function enables filtering of Ax analog value based on the selected sampling mode, and the filtered value is the current value of coil F. Output: The analog value of input Ax is calculated based on the current number of samples Sn.

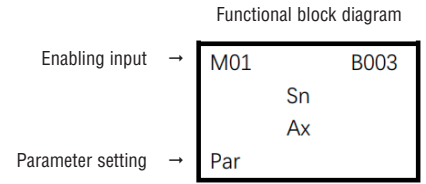
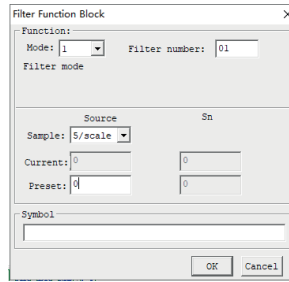
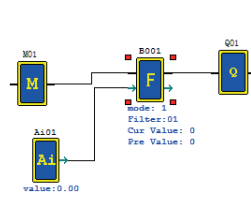

Software filter mode:

- (Mode 1): Data is updated in each scanning cycle, and the recent 5 AD values (maximum and minimum values removed) is averaged.
- (Mode 2): Data is updated every 5 scanning cycles. The average values of mode 1 are further averaged after statistics for 5 times.
- (Mode 3): Data is updated every 25 scanning cycles. The maximum and minimum averages of the values obtained in mode 2 are used after statistics for 5 times.

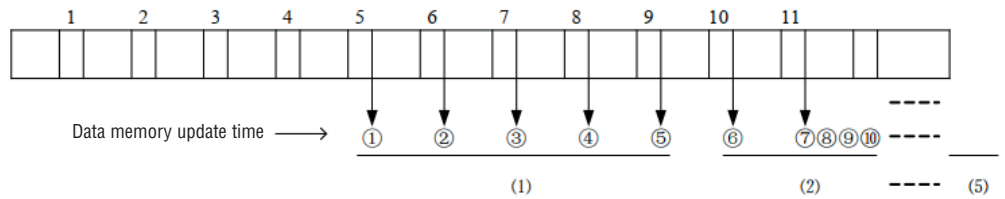

Example: Data 1=161, data 2=120, data 3=154, data 4=160, data 5=190, data 6=169, data 7=110, data 8=121, data 9=150, data 10=198, data 11=199.

Mode 1:

- ① Updated data = (161 + 154 + 160) / 3 = 158 - filter (1, 2, 3, 4, 5) Maximum value 190 and minimum value 120 will be deleted.
- ② Updated data = (154 + 160 + 169) / 3 = 161- filter (2, 3, 4, 5, 6) Maximum value 190 and minimum value 120 will be deleted.
- ③ Updated data =(154 + 160 + 169) / 3 = 161- filter (3, 4, 5, 6, 7) Maximum value 190 and minimum value 110 will be deleted.
- ∴
- ⑦ Updated data=(121 + 150 + 198) / 3 = 156 - filter (7, 8, 9, 10, 11) Maximum value 199 and minimum value 110 will be deleted.

Mode 2:

The 5 data values of mode 1 are averaged. (① + ② + ③ + ④ + ⑤) / 5

Mode 3:

Among the 5 data values obtained after 5 operations of mode 2, the maximum value and minimum value are taken, and then the two values are averaged.
 This mode is effective in filtering ripple or ripple noise.
 (Maximum value + minimum value) / 2 (wherein, the maximum and minimum value range is (1)(2)(3)(4)(5)).

FILTER MODE 2: AVERAGE VALUE

The enabling coil is set ON to enable the average function, which is used to calculate the average value of analog inputs in the set time period.

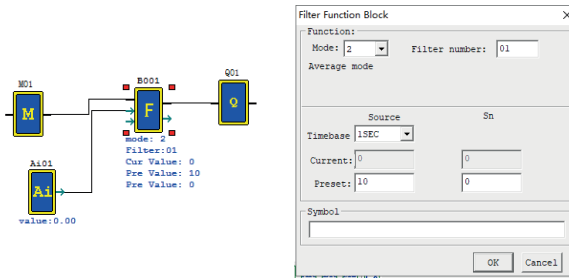

After the enabling coil is set ON, the average value of analog inputs in the set time period is calculated based on the configured parameters and updated to the current value of functional block, and meanwhile, output coil is set ON.

Timing diagram (for example)

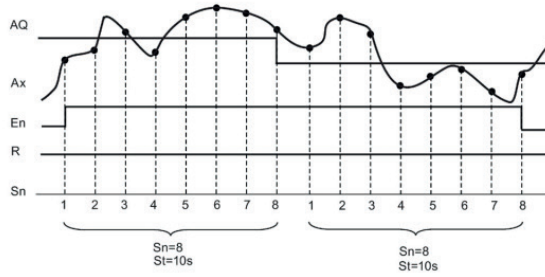

FILTER MODE 3: MAXIMUM VALUE

The maximum value function is enabled and status of output coil and enabling coil is consistent after the enabling coil is set ON, and the function is disabled and status of output coil and enabling coil is consistent after the enabling coil is set OFF. While the enabling coil is ON, the current value of block F is recorded as the maximum value of analog input Ax.

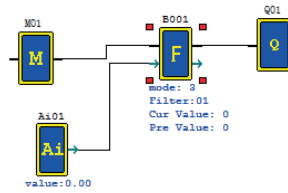

FILTER MODE 4: MINIMUM VALUE

The minimum value function is enabled and status of output coil and enabling coil is consistent after the enabling coil is set ON, and the function is disabled and status of output coil and enabling coil is consistent after the enabling coil is set OFF. While the enabling coil is ON, the current value of block F is recorded as the minimum value of analog input Ax.

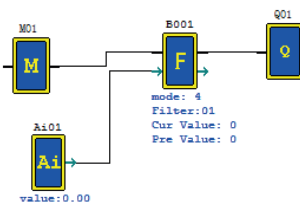

ADDITION AND SUBTRACTION FUNCTIONAL BLOCK DIAGRAM

The maximum number of addition and subtraction functional blocks used under FBD is 250. The function is the same as under Ladder.

Computing formula: $AS = V1 + V2 - V3$

Operand V1-V3 may be a constant or code of current value of another functional block. Output coil is set ON in case of AS result overflow.

Example:

$AQ01 = AS01 = 100 + A01 - V02$

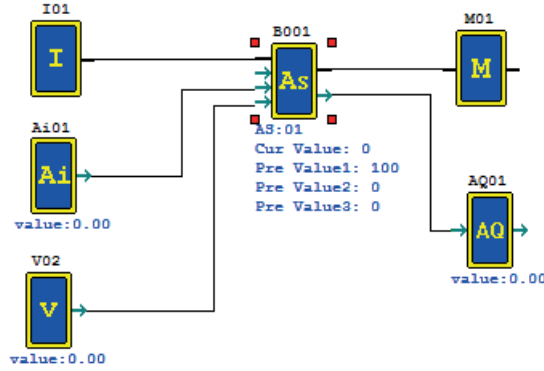

AS Function Block ✕

Function: $AS=V1+V2-V3$

AS number:

Current Value:

Preset V1:

Preset V2:

Preset V3:

SYMBOL

Functional block diagram

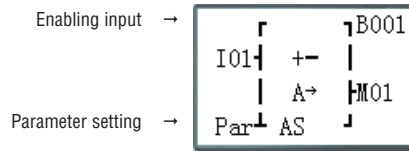

Parameter display

	STOP	RUN																	
	<table style="width: 100%; border-collapse: collapse;"> <tr> <td style="width: 50%; border-right: 1px solid gray; padding: 2px 5px;">B001</td> <td style="padding: 2px 5px;">AS01</td> </tr> <tr> <td style="border-right: 1px solid gray; padding: 2px 5px;">V1= 00100</td> <td style="padding: 2px 5px;"></td> </tr> <tr> <td style="border-right: 1px solid gray; padding: 2px 5px;">V2= A01</td> <td style="padding: 2px 5px;"></td> </tr> <tr> <td style="border-right: 1px solid gray; padding: 2px 5px;">V3= V02</td> <td style="padding: 2px 5px;"></td> </tr> </table>	B001	AS01	V1= 00100		V2= A01		V3= V02		<table style="width: 100%; border-collapse: collapse;"> <tr> <td style="width: 50%; border-right: 1px solid gray; padding: 2px 5px;">B001 00404</td> <td style="padding: 2px 5px;">AS01</td> </tr> <tr> <td style="border-right: 1px solid gray; padding: 2px 5px;">V1= 00100</td> <td style="padding: 2px 5px;"></td> </tr> <tr> <td style="border-right: 1px solid gray; padding: 2px 5px;">V2= 00424</td> <td style="padding: 2px 5px;"></td> </tr> <tr> <td style="border-right: 1px solid gray; padding: 2px 5px;">V3= 00120</td> <td style="padding: 2px 5px;"></td> </tr> </table>	B001 00404	AS01	V1= 00100		V2= 00424		V3= 00120		← AS output value
B001	AS01																		
V1= 00100																			
V2= A01																			
V3= V02																			
B001 00404	AS01																		
V1= 00100																			
V2= 00424																			
V3= 00120																			
Preset value V1 →			← V1 current value																
Preset value V2 →			← V2 current value																
Preset value V3 →			← V31 current value																

The range of AS output value and V1-V3 current value is -32768~32767.

MULTIPLICATION AND DIVISION FUNCTIONAL BLOCK DIAGRAM

The maximum number of multiplication and division functional blocks used under FBD is 250. The function is the same as under Ladder.

Computing formula: $MD = V1 * V2 / V3$

Operand V1-V3 may be a constant or code of current value of another functional block. Output coil is set ON in case of MD result overflow or V3=0.

Example:
AQ02 = MD01 = AT01*15/100

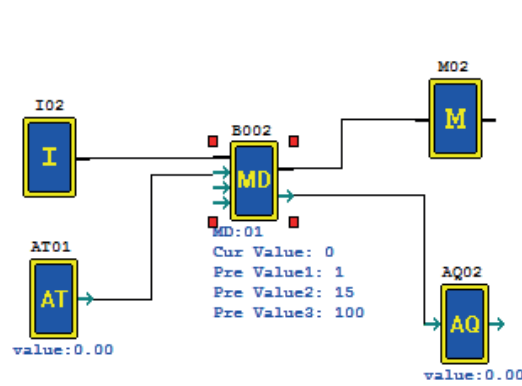

MD Function Block ✕

Function: MD=V1*V2/V3

MD number:

Current Value:

Preset V1:

Preset V2:

Preset V3:

SYMBOL

Functional block diagram

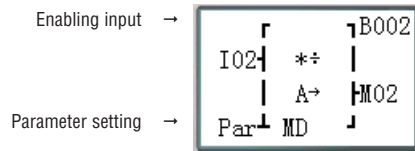

Parameter display

	STOP	RUN	
	B002 MD01	B002 00184 MD01	← MD output value
Preset value V1 →	V1= AT01	V1= 01227	← V1 current value
Preset value V2 →	V2= 00015	V2= 00015	← V2 current value
Preset value V3 →	V3= 00100	V3= 00100	← V31 current value

The range of MD output value and V1-V3 current value is -32768-32767.

PID FUNCTIONAL BLOCK DIAGRAM

The maximum number of analog comparator functional blocks used under FBD is 30. The function is the same as under Ladder.

PID computing formula:

$$EV_n = SV - PV_n$$

$$\Delta PI = K_p \left\{ (EV_n - EV_{n-1}) + \frac{T_s}{T_i} EV_n + D_n \right\}$$

$$D_n = \frac{T_d}{T_s} (2PV_{n-1} - PV_n - PV_{n-2})$$

$$PI = \sum \Delta PI$$

PI: PID current value (-32768~32767)
SV: target value (-32768~32767)
PV: measured value (-32768~32767)
TS: sampling time (1~32767 * 0.01s)
KP: proportional gain (1~32767%)
TI: integral time (1~32767 * 0.1s)
TD: differential time (1~32767 * 0.01s)

PID parameters may be a constant or code of current value of another functional block. Error coil is set as 1 and PID function is not executed when TS or KP is 0.

Example:

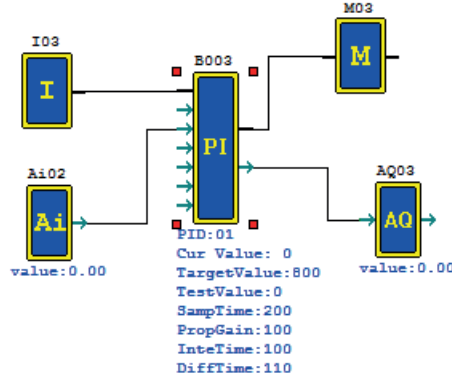

PID Function Block ✕

Function:

PID number:

Current Value:

SV:

PV:

Ts:

Kp:

Ti:

Td:

Symbol

Functional block diagram

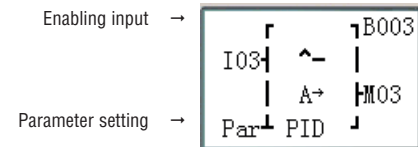

Parameter display

	STOP	RUN	
PI output value →	B003 00738 PI01	B003 PI01	
Target value SV →	SV= 00800	Kp= 00100	← Proportional gain Kp
Measured value PV →	PV= 00770	Ti= 0010.0Sec	← Integral time Ti
Sampling time Ts →	Ts= 002.00Sec 1	Td= 001.10Sec 2	← Differential time Td

- * PI output value is displayed only during running;
- * The code A02 is displayed when stopped and the current value of A02 is displayed during running; the measured value PV is preset, such as PV=00770;
- * Press "SEL+←→", to switch parameter display 1 and 2;
- * Refer to Chapter IV: Ladder Programming Instructions-PID Functional Block Instructions for details on PID.

MULTIPLEX CONTROLLER (MX) FUNCTIONAL BLOCK DIAGRAM

The maximum number of multiplex controller functional blocks used under FBD is 30. The function is the same as under Ladder.

When MX is enabled, status of S1 and S2 is input as per setting, output value of MX is one of the preset parameters V0-V3, and coil outputs ON; when MX is disabled, MX output is 0 and coil outputs OFF.

Operand V1-V3 may be a constant or code of other data type.

The relation between selection control bit and MX current value is shown in the following table.

Control condition		MX output coil	MX output value
MX disabled		0	MX = 0
MX enabled	S1 = 0, S2 = 0	1	MX = V0
	S1 = 0, S2 = 1	1	MX = V1
	S1 = 1, S2 = 0	1	MX = V2
	S1 = 1, S2 = 1	1	MX = V3

Example:

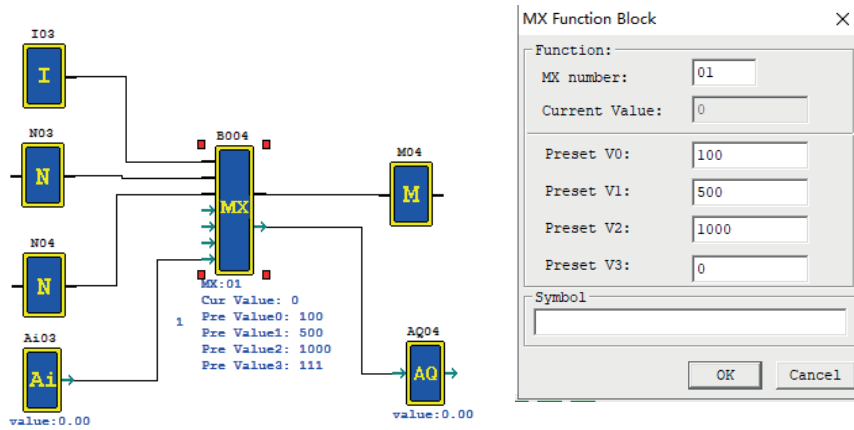

Functional block diagram

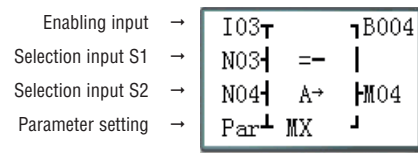

Parameter display

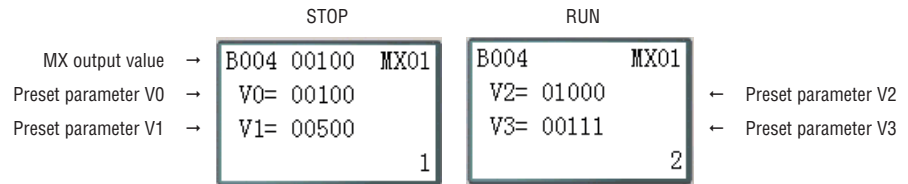

- * MX output value is displayed only during running;
- * The code A03 is displayed when stopped and the current value of A03 is displayed during running; the parameter V3 is preset, such as V3=00111
- * Press "SEL+←→", to switch parameter display 1 and 2;
- * The range of MX output value and current value of preset parameters V0-V3 is -32768-32767.

RAMP FUNCTION GENERATOR (AR) FUNCTIONAL BLOCK DIAGRAM

The maximum number of AR functional blocks used under FBD is 30. The function of AR mode 1 and mode 2 is the same as under Ladder.

AR MODE 1

Function description:

After AR is enabled, the current level is kept at "Start/Stop offset+ offset" for 100ms, and then changed to the set level at the set stepping rate. If the stop coil is enabled, AR level is gradually decreased from the current level to "Start/Stop offset+ offset" at the set stepping rate and kept at this level for 100ms, then the current level is offset B, making AR current value 0, when AR instruction ends.

AR current value (AR: 0~32767)
Level 1 (Levl1: -10000~20000)
Level 2 (Levl2: -10000~20000)
Maximum level (MaxL:-10000~20000)
Start/Stop offset (StSp: 0~20000)
Stepping rate (Rate: 1~10000/s)
Gain (A: 0~10.00)
Offset (B: -10000~10000)

$$AR\ current\ value = (AR\ current\ level - offset\ B) / gain\ A$$

The preset parameters may be a constant or code of other data type; output coil is set ON when gain A is 0.

Level selection coil Sel	Level selection rule Sel = 0: Lev1 as the target level Sel = 1: Lev2 as the target level * MaxL is taken as the preset value of target level if the target level is higher than the maximum level.
Stop coil St	When the stop coil is set ON (not kept), AR is stopped, decreased gradually from the current level to "Start/Stop offset+ offset" and kept at the level for 100ms, then the current level is offset B, leading to the current value 0, when AR instruction is ended.

AR mode 1 timing diagram

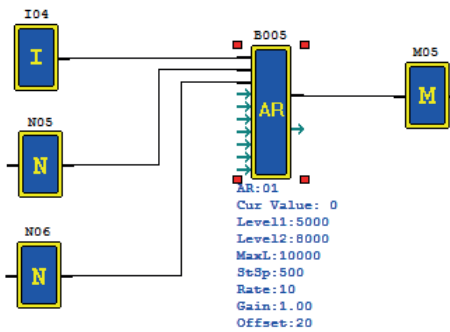
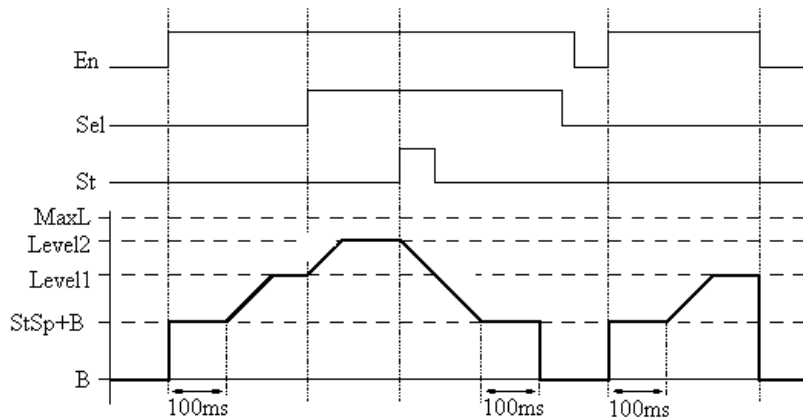

AR Function Block

Function: Mode: 1 AR number: 01

Current Value: 0

Level1: 5000

Level2: 8000

MaxL: 10000

StSp: 500

Rate: 10

Gain: 1.00

Offset: 20

Symbol

OK Cancel

Functional block diagram

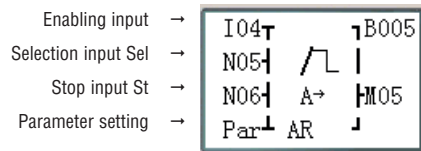

Parameter display

	STOP	RUN	
AR output value	B005 00528 AR01	S = 00500 AR01	← Preset StSp
Preset level L1	L1= 05000	R = 00010	← Preset rate
Preset level L2	L2= 08000	A = 01.00	← Preset gain
Preset maximum value	ML= 10000 1	B = 00020 2	← Preset offset

* AR output value is displayed only during running;
* Press "SEL+←→" for switching of parameter display 1 and 2.

AR MODE 2

Function description:

In AR02, the current output level is decided by level selection ports Sel1 and Sel2, and the fixed variation Rate by parameters MaxL and Ta. After AR is enabled, AR output will change from 0 to the current output level at the Rate. Afterwards, AR output will change to the target level at the fixed rate as per variation of selection ports Sel1 and Sel2. After AR is OFF, AR output will turn from the current level to 0 immediately.

AR current value (AR:0-32767)
Level 0 (Leve0:0-32767)
Level 1 (Leve0:0-32767)
Level 2 (Leve0:0-32767)
Level 3 (Leve0:0-32767)
Level upper limit (MaxL:0-32767)
Acceleration time Ta: 0-3276.7

User-defined rate: $Rate = \frac{MaxL}{Ta}$. AR mode 2 is detailed below:

Level selection coil Sel	Level selection rule Sel = 0: Lev1 as the target level Sel = 1: Lev2 as the target level * MaxL is taken as the preset value of target level if the target level is higher than the maximum level.
Stop coil St	When the stop coil is set ON (not kept), AR is stopped, decreased gradually from the current level to "Start/Stop offset+ offset" and kept at the level for 100ms, then the current level is offset B, leading to the current value 0, when AR instruction is ended.

AR mode 1 timing diagram

Sel1 Sel2	S1 0,S2 0: target level = Level 0; S1 0,S2 1: target level = Level 1; S1 1,S2 0: target level = Level 2; S1 1,S2 1: target level = Level 3;
MaxL	MaxL is taken as the target level if the selected level is higher than the maximum level.
Ta	Quotient of MaxL/Ta rate as the rate of variation to target level

AR mode 2 timing diagram

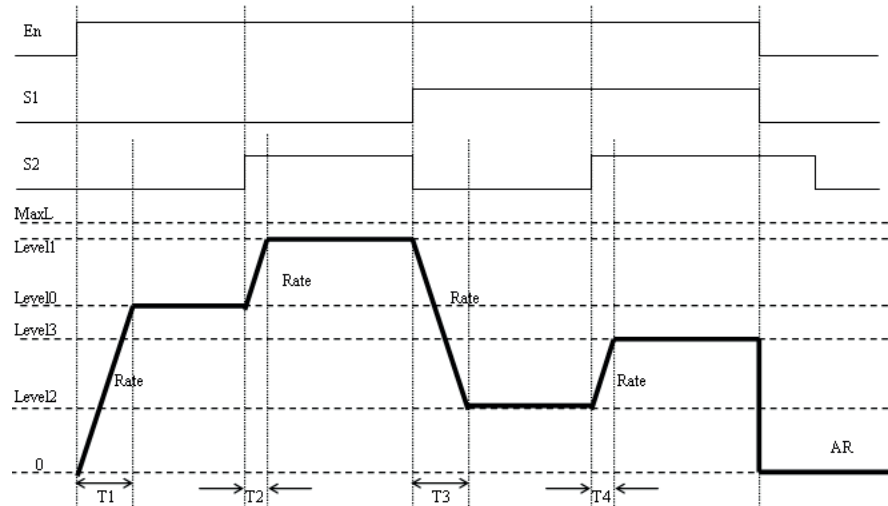

Rate = MaxL/Ta; T1=Level0*Ta/MaxL; T2= (Level1-Level0)*Ta/MaxL;
T3= (Level1-Level2)*Ta/MaxL; T4= (Level3-Level2)*Ta/MaxL;

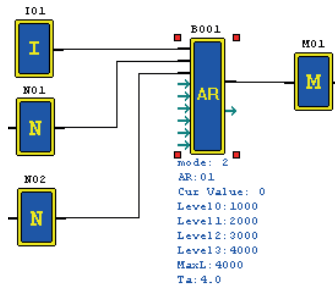

X

AR Function Block

Function:

Mode: AR number:

Current Value:

Level0:

Level1:

Level2:

Level3:

MaxL:

Ta:

Symbol:

OK Cancel

Example:

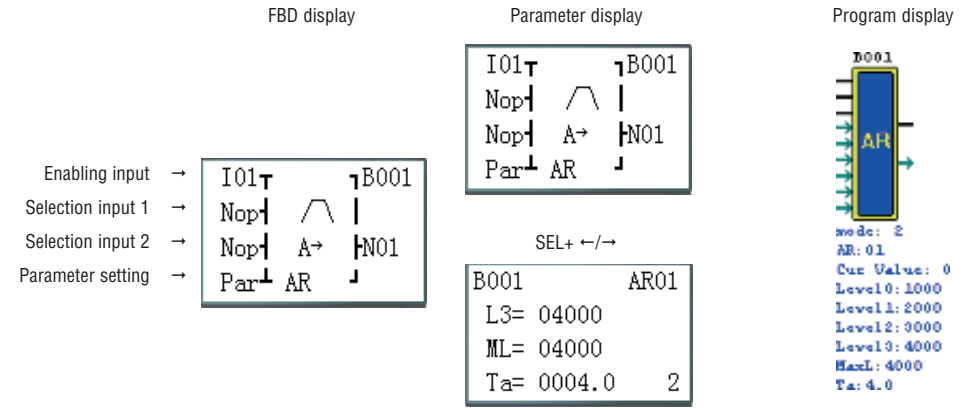

* AR output value is only displayed during running.

DATA REGISTER (DR) FUNCTIONAL BLOCK DIAGRAM

The maximum number of DR functional blocks used under FBD is 240. The function is the same as under Ladder.

When DR is enabled, the preset value is transferred to DR current value register, and coil B outputs ON; when DR is disabled, the current value is kept and coil B outputs OFF.

Data in DR may be the type with symbol or the type without symbol, and the control bit can be set by LRK user programming software menu Operation (O)>>Module system setting(D)...or keypad.

- * The current value of DR65-DRF0 is kept when stopped and in case of power failure;
- * The final 40 DRs are special data registers, as defined in Chapter III: Programming Tool- DR Setting.

Example:

When I01 is set ON, A05 is transferred to B003 as the preset value V2 after B002 computation;

When I02 is set ON, B003 outputs to block B001 the preset value V2, namely the computed value of analog input A05; when I02 is set OFF, B003 outputs 0 to B001.

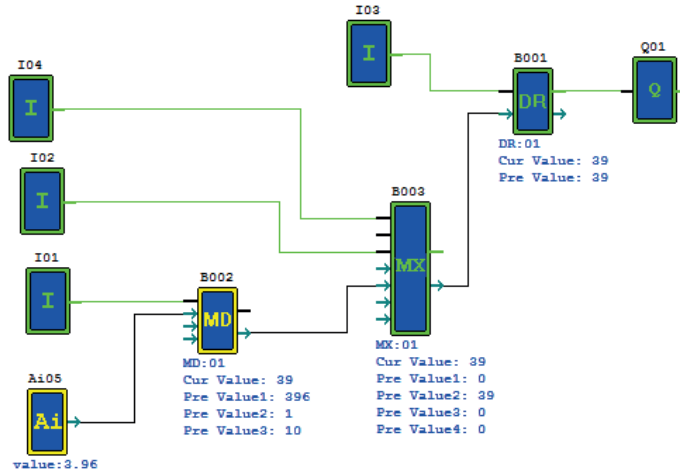

MODBUS FUNCTIONAL BLOCK DIAGRAM

The maximum number of Modbus functional blocks used under FBD is 250. Modbus works in mode 1-5, and its function is the same as under Ladder.

RS485 communication gives priority to Remote IO and IO Link, namely the functional block is not executed by Remote IO master and slave and IO Link master, and Modbus instruction is executed only when it is set as N (remote IO) and ID is not 0.

Comparison table of Modbus mode and communication function code:

Mode	Function code
1	03 (read register)
2	06 (write a single register)
3	10 (write various registers)
4	01 (read coil)
5	05 (write a single coil)

* The maximum communication data length is 25 words in mode 1 and 3, and 400 bits in mode 4.

Auxiliary contacts used during execution of Modbus instructions:

Receiving completed M3D	After completion of receiving, M3D is set for error checking, and the received data is sent to the designated register if no error is found;
Error indication M3E	Communication error indication
Timeout judgment M3F	Enter the receiving waiting state after completion of sending; when timeout is determined as no data is received within the specified time period, the timeout output flag M3F is ON, receiving is ended and M3D outputs ON; M3F is automatically reset at the time of M3D resetting.

Timeout judgment and time-out period are determined by baud rate.

Baud rate (bps)	Timeout (ms)
4800, 9600, 19200, 38400	125
57600	100
115200	80

* Refer to Chapter VII: Function Specification of 20-point RS485 High-performance Type for use of communication.

MU MODE 1: READ REGISTER

Set communication address as a constant:

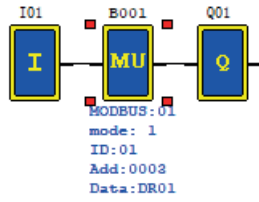

Set command address constant 0003,
Set data length as 1 word,
The sending command is:
01 03 00 03 00 01 CRC16;

Receiving response data of slave station 1:
01 03 02 data1 data2 CRC16;

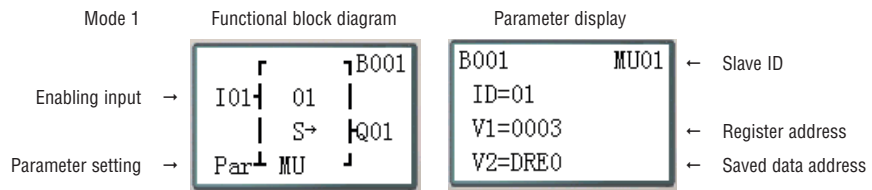
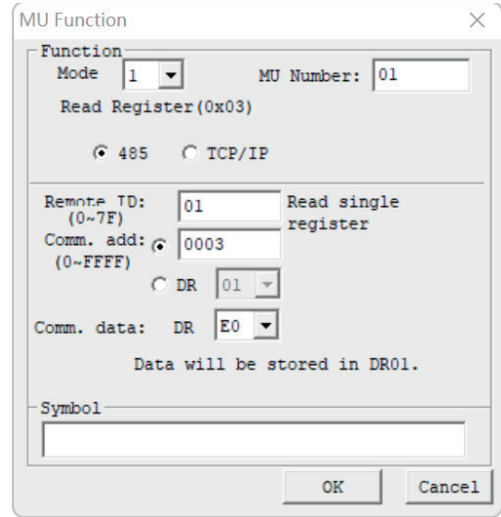

Set communication address as register DR:

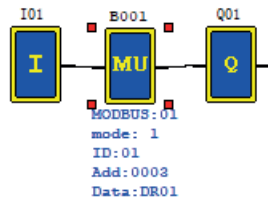

Set command address DR03=0001,
Set data length DR04=0002,
The sending command is:
01 03 00 01 00 02 CRC16;
Receiving response data of slave station 1:
01 03 04 data1 data2 data3 data4 CRC16;
Data saved in DRE0-DRE1:
DRE0 = data1~2, DRE1 = data3~4

* The maximum value of data length register is 25.

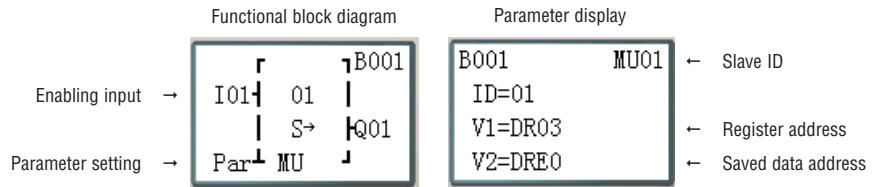
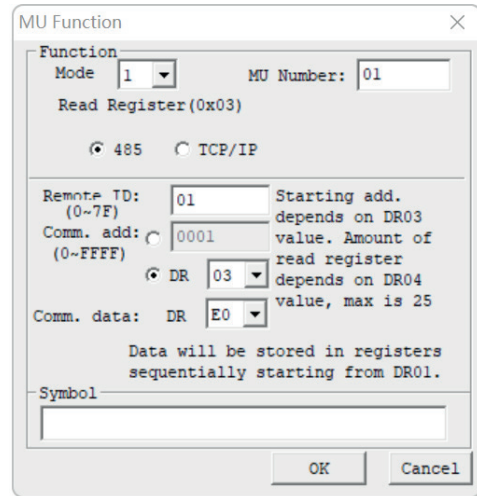

MU MODE 2: WRITE A SINGLE REGISTER

Set communication address as a constant:

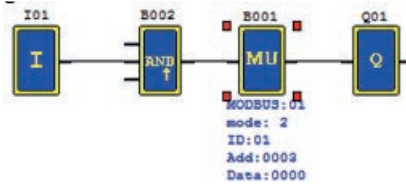

Command address constant 0003,
Set value data DRE0=1234 (hex: 04D2),
The sending command is:
01 06 00 03 04 D2 CRC16;

Receiving response data of slave station 1:
01 06 00 03 04 D2 CRC16;

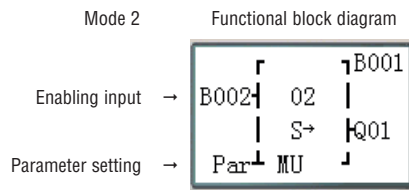

Parameter display

B001	MU01	← Slave ID
ID=01		
V1=0003		← Register address
V2=DRE0		← Saved data address

Set communication address as register DR:

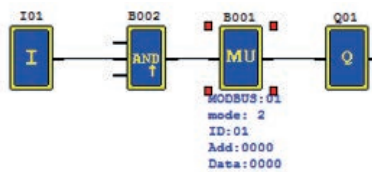

Set command address DR03=0001,
Set data length DR04=0002,
The sending command is:
01 03 00 01 00 02 CRC16;
Receiving response data of slave station 1:
01 03 04 data1 data2 data3 data4 CRC16;
Data saved in DRE0-DRE1:
DRE0 = data1~2, DRE1 = data3~4

* The maximum value of data length register is 25.

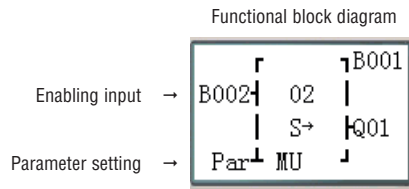

Parameter display

B001	MU01	← Slave ID
ID=01		
V1=DR03		← Register address
V2=DRE0		← Saved data address

MU MODE 3: WRITE VARIOUS REGISTERS

Set communication address as a constant:

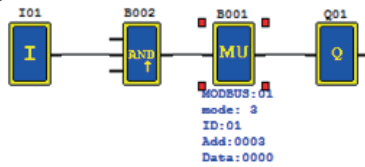

Command address constant 0003,
Set data length as 1 word,
Set data DRE0=1234 (hex: 04D2),
The sending command is:
01 10 00 03 00 01 02 04 D2 CRC16;

Receiving response data of slave station 1:
01 10 00 03 00 01 CRC16;

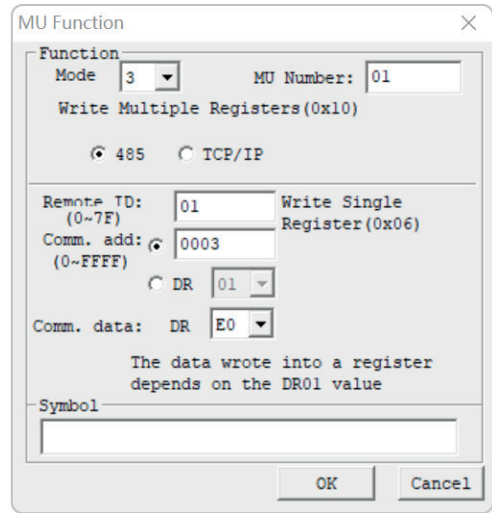

Mode 3	Functional block diagram	Parameter display	
Enabling input →		B001 MU01 ← Slave ID	
Parameter setting →		ID=01 ← Register address	
		V1=0003 ← Saved data address	
		V2=DRE0	

Set communication address as register DR:

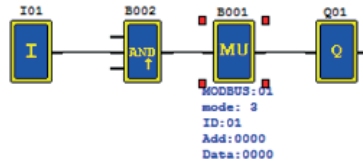

Set command address DR03=0001,
Set data length DR04=0002,
Set data DRE0=1234 (hex:04D2),
Set data DRE1=5678 (hex:162E),
The sending command is:
01 10 00 01 00 02 04 04 D2 16 2E CRC16;

Receiving response data of slave station 1:
01 10 00 01 00 02 CRC16;

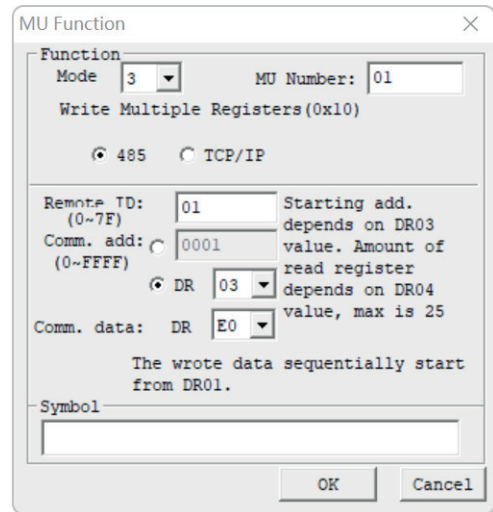

Mode 3	Functional block diagram	Parameter display	
Enabling input →		B001 MU01 ← Slave ID	
Parameter setting →		ID=01 ← Register address	
		V1=DR03 ← Saved data address	
		V2=DRE0	

MU MODE 4: READ COIL

Set communication address as a constant:

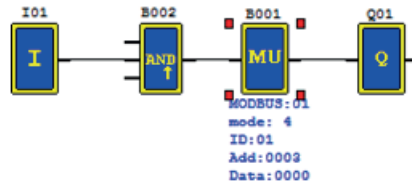

Command address constant 32 (hex: 0020),
Set data length as 16 (hex: 10H, 1word),
The sending command is:
01 01 00 20 00 10 CRC16;

Receiving response data of slave station 1:
01 01 02 data1 data2 CRC16;
Data saved in DRE0:

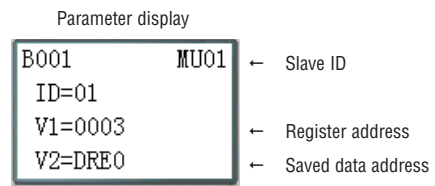
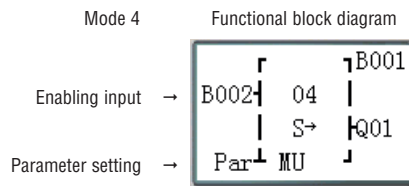
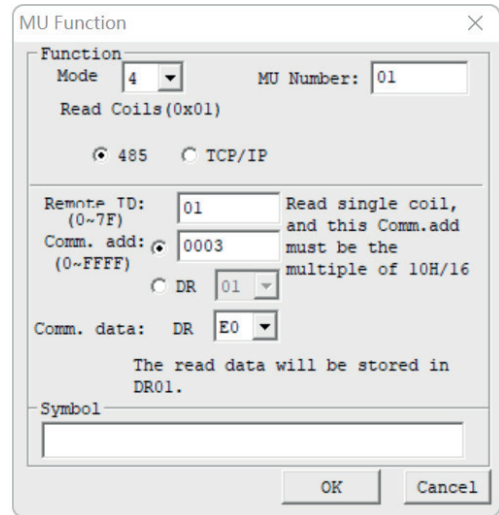

Set communication address as register DR:

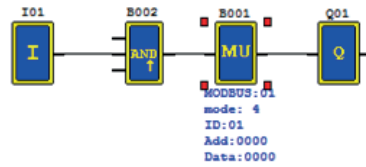

Set command address DR03=0001,
Set data length DR04=0015 (hex: 000F);
The sending command is:
01 01 00 01 00 0F CRC16

Receiving response data of slave station 1:
01 01 02 data1 data2 CRC16;
Data saved in DRE0: DRE0 = data1~2

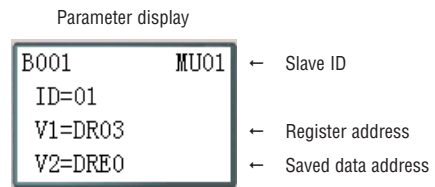
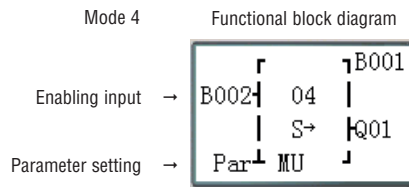
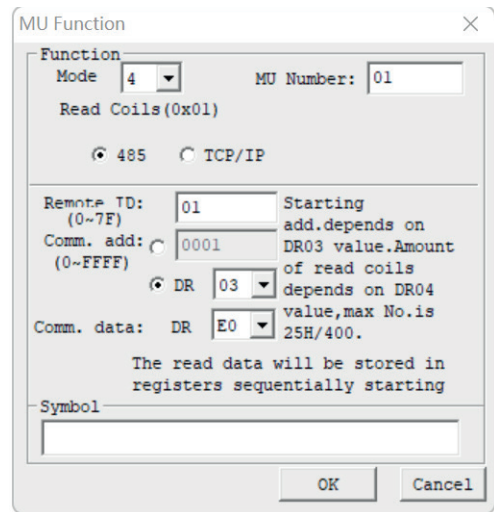

MU MODE 5: WRITE A SINGLE COIL

Set communication address as a constant:

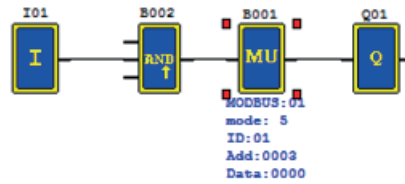

Command address constant 0003,
Set data DRE0=65280 (hex: FF00),
The sending command is:
01 05 00 03 FF 00 CRC16;

Receiving response data of slave station 1:
01 05 00 03 FF 00 CRC16;

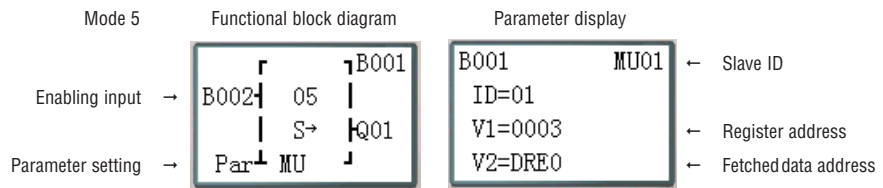

Set communication address as register DR:

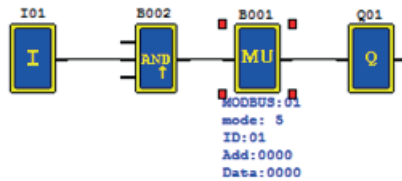

Set command address DR03=0001,
Set data DRE0=65280 (hex: FF00),
The sending command is:
01 05 00 01 FF 00 CRC16

Receiving response data of slave station 1:
01 05 00 01 FF 00 CRC16;

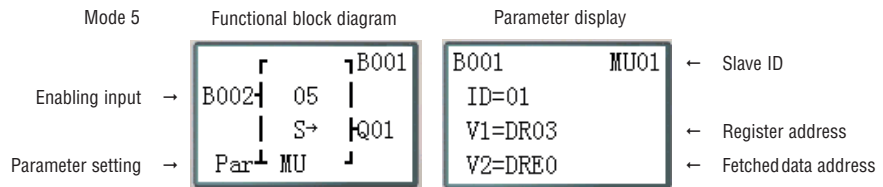

Chapter 7 Hardware Specifications

Chapter 7 Hardware Specifications	180
General Specifications	181
Input Power Specifications (current consumption to be tested)	181
General type specifications	181
Schematic diagram of incoming power line:	182
Input Specifications	183
100~240VAC type	183
12/24VDC type 12 I/O	183
12/24VDC type 20 I/O	184
Output Specifications	184
Precautions for Output Terminal Connection	185
Relay life	185
Outline Drawing (unit: mm)	185

GENERAL SPECIFICATIONS

Item		Specification
Program input method		Ladder and FBD
Operating environment	Operating temperature	-20~50°C
	Storage temperature	-40~70°C
	Operating humidity	90% RH, no condensation
	Operating gas	Non-corrosive gas
Body structure	Vibration resistance	IEC60068-2-6 Amplitude 0.075mm /acceleration 1.0G
	Impact resistance	IEC60068-2-27 Peak 15G peak, duration 11ms
Noise resistance	ESD	Contact ±4KV, air discharge ±8KV
	EFT	Power supply AC: ±2KV DC: ±1KV
	CS	0.15~80MHz 10V/m
	RS	80~1000MHz 10V/m
	EMI	EN55011 B level
Installation	Protection grade	IP20
	Fixing method	Direct mounting or rail (35mm) mounting
	Direction	Refer to Chapter II: Installation and Fixing
Assembly wire		AWG 14/ψ2.6mm ²
Dimensions		For:10/12P 72X90X59.6mm (W x H x D) Din rail 72X106X59.6mm (W x H x D) direct mounting For:20P 126X90X59.6mm (W x H x D) Din rail 126X106X59.6mm (W x H x D) direct mounting

INPUT POWER SPECIFICATIONS (CURRENT CONSUMPTION TO BE TESTED)

General type specifications

Item	LRK10RA240	LRK12RD024 LRK12RD024B	LRK20RD024RS
Rated voltage	100-240VAC	10...28.8VDC	
Voltage range	85-265VAC	-	-
Rated frequency	50/60Hz	-	-
Frequency range	47-63Hz	-	-
Allowable instantaneous power-off time	10ms (half cycle) / 20 times (IEC 61131-2)	1ms / 10 times (IEC 61131-2)	1ms / 10 times (IEC 61131-2)
Power fuse	1A fuse	1A fuse	1A fuse
Insulation	None	None	None
Average current consumption	90mA	300mA	400mA

Schematic diagram of incoming power line:

1) AC 10/20 points

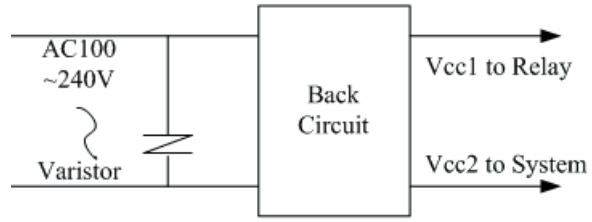

2) DC 24V (power supply 12/24)

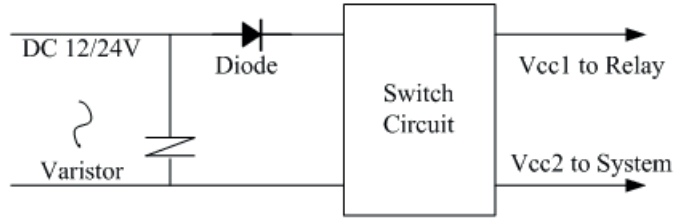

3) Master, extension and communication

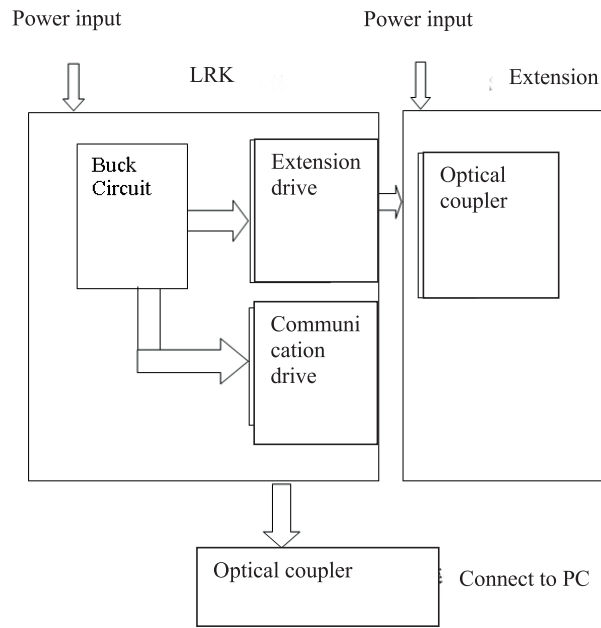

Input Specifications

100~240VAC type

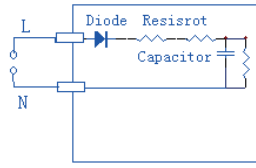
Item	LRK10RA240
Input circuit components	I1-I6 
Quantity	6 (digital input)
Input Signal current	AC 240V 1.3mA
Input ON current	> AC 79V /0.41mA
Input OFF current	< AC 40V /0.28mA
Wire length	< / = 100m
Input Response time	On=>Off
	Typical 50/60Hz 50/45ms(AC 110V)
	Typical 50/60Hz 90/85ms(AC 220V)
	Off=>On
	Typical 50/60Hz 50/45ms(AC 110V) Typical 50/60Hz 22/18ms(AC 220V)

12/24VDC type 12 I/O

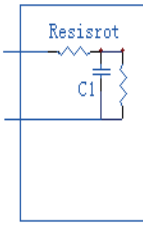
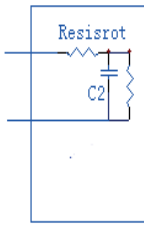
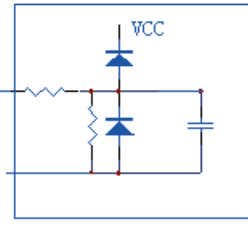
Item	LRK12RD024 - LRK12RD024B		
	General digital input I3-I6	High speed input I1, I2	Analog input A1, A2
Input circuit components			
Quantity	4	2	2
Input signal current	3.2mA:12/24VDC	3.2mA:12/24VDC	<0.17 mA/0~10V
Input ON current	>1.52mA/10V	>1.52mA/10V	>0.161mA/9.8V
Input OFF current	< 1.136mA/7.5V	< 1.136mA/7.5V	< 0.085mA/5V
Wire length	< / = 100m	< / = 100m	< / = 100m < / = 30m (shielded wire)
Input response time	On=>Off	On=>Off	On=>Off
	0.3ms	0.03ms	Typical: 5ms
	Off=>On	Off=>On	Off=>On
	0.6ms	0.4ms	Typical: 3ms
Input voltage	-	-	-
Display class	-	-	0~10VDC
Conversion bits	-	-	0.01VDC
Error with actual value	-	-	12
Conversion time	-	-	±2%±0.12V
Sensor resistance	-	-	1 CPU scanning cycle
	-	-	<1Kohm

12/24VDC type 20 I/O

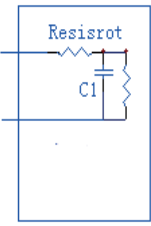
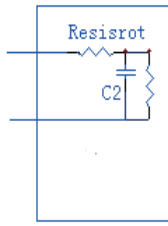
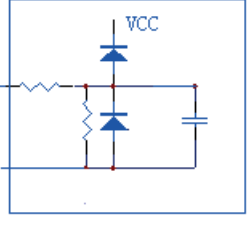
Item	LRD20RD024RS			
	General digital input	High speed input	Analog input	
Input circuit components	I3~I6 	I1, I2 	A1 A2 A3 A4 	
Quantity	6	2	4	
Input signal current	3.2mA:12/24VDC	3.2mA:12/24VDC	<0.17 mA/0~10V	
Input ON current	>1.52mA/10V	>1.52mA/10V	>0.163mA/9.8V	
Input OFF current	< 0.625mA/7.5V	< 0.625mA/7.5V	< 0.083mA/5V	
Wire length	< / = 100m	< / = 100m	< / = 100m	< / = 30m (shielded wire)
Input response time	On=>Off	On=>Off	On=>Off	
	0.3ms	0.03ms	Typical: 5ms	
	Off=>On	Off=>On	Off=>On	
	2ms	0.4ms	Typical: 3ms	
Input voltage	-	-	0~10VDC	
Display class	-	-	0.01VDC	
Conversion bits	-	-	12	
Error with actual value	-	-	±2%±0.12V	
Conversion time	-	-	1 CPU scanning cycle	
Sensor resistance	-	-	<1Kohm	

Output Specifications

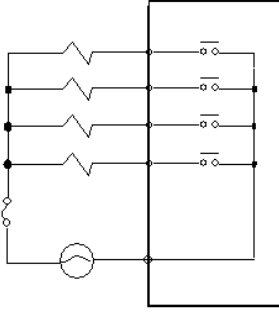
Item	Relay output	
Output circuit components		
External power	External power LRK	
External power	Below AC240V	
Circuit insulation	Mechanical insulation	
Max load	Resistive load	8A/point
Open contact leakage current	-	
Min. load	-	
Response	OFF to ON	About 15 ms
	ON to OFF	About 15 ms

PRECAUTIONS FOR OUTPUT TERMINAL CONNECTION

Relay life

Life expectancy

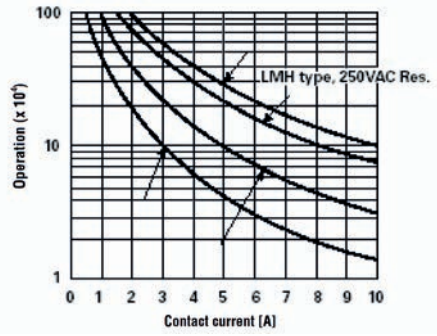

Note 1: The above shown is standard value, but relay life may be affected by temperature of the operating environment.
 Note 2: Relay life is generally over 100 thousand times when current is below 2A.

DIMENSIONS (unit: mm)

LRK12RD024 – LRK10RA240

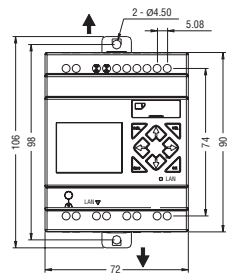

LRK20RD024RS

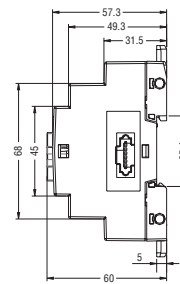
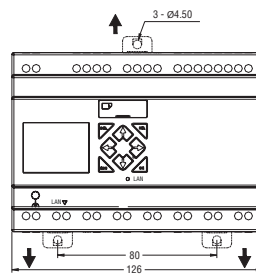

LRK12RD024B

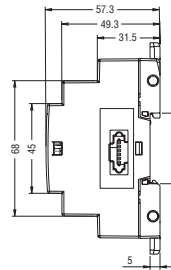
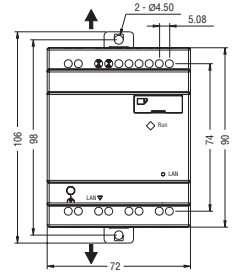

Chapter 8 Function Specification of LRK20RD024RS Type

Chapter 8 Function Specification of LRK20RD024RS Type	186
Communication Specifications	187
Function Description	188
MU instructions (Modbus communication master function)	191
Modbus communication slave function	193
ModBus communication protocol	193

The RS485 interface of LRK20RD024RS can be connected to industrial equipment with RS485 communication function and itself. Take two LRK20RD024RS communicating through RS485 interface as an example (one host and one slave). The master and slave positions have the following requirements:

- If the slave is placed on the left or right of the host, it shall be at least 10mm away from the host;
- If the host is connected to the module, the slave should be placed behind the module, at least 10mm away from the module;
- The slave can only be placed on the left or right sides of the host.

Communication Specifications

Note: Any function using RS485 communication port requires for setting the matching functional and communication parameters to ensure normal use.

The functional and communication parameters of LRK RS485 port are optional and can be set according to the following 2 methods:

● PC-connected software setting

- Open the dialog box "Module System Set" in the "Operation" menu of PC-connected software.
- Set ID, Remote I/O and RS485 Set in the dialog box as shown below:

● LRK keypad setting:

- Press to enter the main menu;
- Move the cursor to the system setting menu and press OK;
- Press to enter the setting menu for setting of ID, Remote I/O and RS485, as shown below.

- In RS485 setting, the upper bit is communication mode and lower bit is baud rate;
- Select the required setting and press OK to save it.

Functional parameters:

ID setting	01	→	ID setting (00~99)
Remote I/O	N	→	Remote I/O mode (N: none M: master S: slave)

Function description:

Function	ID setting	Remote I/O setting	Description
Remote I/O function	00~99	M & S	Two sets (master, slave) connected
I/O Link function	0~7	N	8 sets connected at most; ID setting being continuous 0~7
MU instructions	1~99	N	MU may be enabled when there is no remote I/O and I/O Link function
Modbus communication slave	1~99	N	Slave function may be enabled when there is no remote I/O function, I/O Link function and MU instruction

Communication format parameters:

RS485 setting	Data	Meaning
Communication mode	0	8/N/2: 8 data bits without check, 2 stop bits;
	1	8/E/1: 8 data bits with even parity check, 1 stop bit;
	2	8/O/1: 8 data bits with odd parity check, 1 stop bit;
	3	8/N/1: 8 data bits without check, 1 stop bit.
Baud rate	0	4800 bps
	1	9600 bps
	2	19200 bps
	3	38400 bps
	4	57600 bps
	5	115200 bps

* LRK ID is 1 and remote I/O function is none (N) by default.

* LRK communication parameter setting is 8/N/2 (8 data bits without check, 2 stop bits) and baud rate is 38400 bps by default.

* The parameters become effective after power-on again.

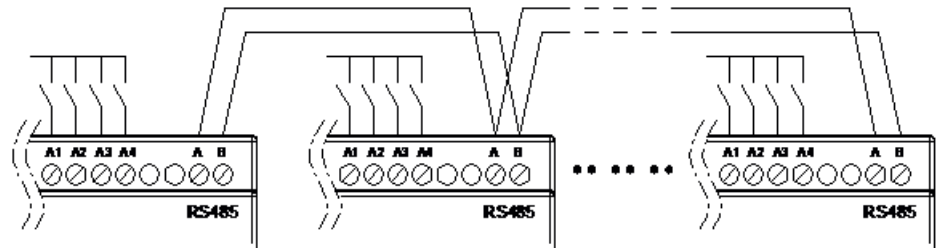

FUNCTION DESCRIPTION

Function description:

LRK slave input (I)/output (Q) is used as extended input (X)/output (Y) of LRK master

I/O address	Master (M)	Slave (S)
Input coil	I01-I0C	
Output coil	Q01-Q08	
Extended input coil	X01-X0C	I01-I0C
Extended output coil	Y01-Y08	Q01-Q08

Hardware setting:

1. Connect A and B lines of two LRK20RD024RS, as shown below

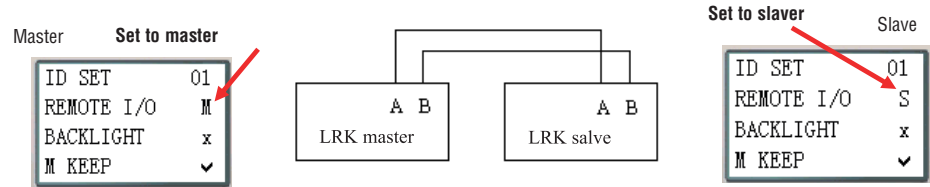

2. Set the REMOTE I/O option under SET menu of one LRK20RD024RS as M (master);
3. Set the REMOTE I/O option under SET menu of another LRK20RD024RS as S (slave);

Logic program runs in the master, but not in the slave.

The master writes extended output Y to slave Q, and the slave writes input I to extended input X of the master.

* Extended I/O module should not be used when remote I/O function is used.

Example:

Write program in LRK master, and run the program to observe status of coils X and Y;

```

X02-----Y01
X03-----Y02

```

Connect input coils I02-I03 in LRK slave and check status of the coils is consistent with coils X02-X03 in LRK master. LRK slave outputs Q01 when I02 is connected, and outputs Q02 when I03 is connected;

I/O status of slave during running

```

I.1 2 3 4 5 6 7 8 9 0 A B C
Z.1 2 3 4
Q.1 2 3 4 5 6 7 8 9 0 A B C
MO 14 : 42

```

Extended I/O status of master during running

```

X.1 2 3 4 5 6 7 8 9 0 A B C
Y.1 2 3 4 5 6 7 8 9 0 A B C
EXE
2010.05.09

```

Function description:

An IO Link is composed of 8 micro-plc type LRK20RD024RS at most, where each contact is used as an independent station for running of its logic program and all slave contacts are connected to the same master station. IO Link ID must be continuous and be 0-7; master station ID is 0, and slave station ID begins from 1 to 7; if slave station ID is not continuous, such as 1, 2, 4, 5, the master station will take it as there are only two slave stations 1 and 2 and communicate with slave stations 1 and 2 only.

When each station uses L01-L08, only one can be set as mode 1: sending mode, and the other L can only be set as mode 2: receiving mode. Sending mode: Address in W table is controlled by ID of LRK itself and cannot be changed, and status of the selected coil is put in the corresponding W table. The correspondence of ID and W table is shown in the following table. Receiving mode: content of the selected W table is transferred to the selected coil; if input coil I or X is selected, content of W table will not change status of coils I and X.

Hardware setting:

1. Connect A and B lines of multiple (1~8 sets) LRK20RD024RS, as shown below

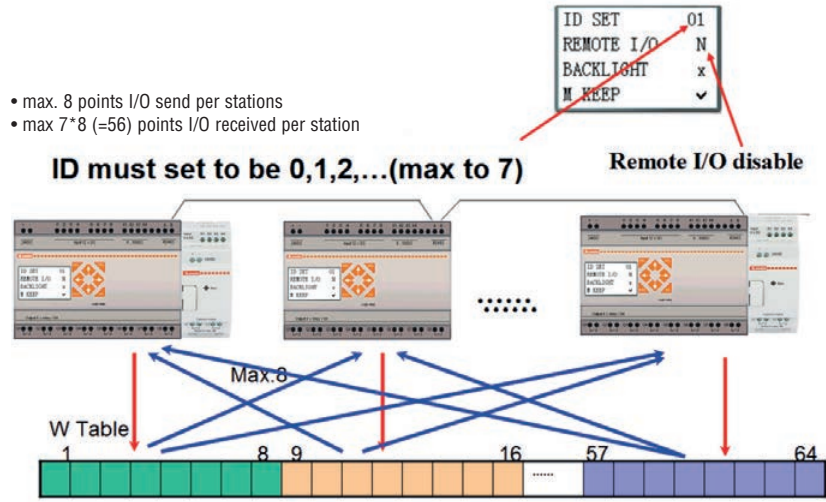

ID	W table comparison
0	W01~W08
1	W09~W16
2	W17~W24
3	W25~W32
4	W33~W40
5	W41~W48
6	W49~W56
7	W57~W64

2. Set the Remote I/O option under LRK SET menu as N (no remote IO) ;
3. Set the ID SET option under LRK SET menu as 00, 01, 02, ...(maximum ID SET is 07).

Example:

1. Connect points A and B of 8 LRK20RD024RS type, as shown above;
2. Set its ID as 00-07, and edit the program under Ladder as below;

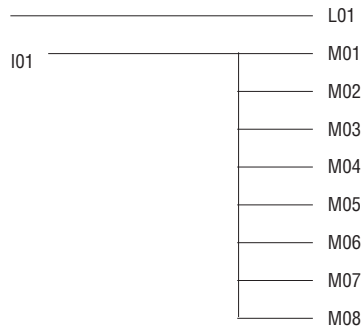

3. Select LRK program with ID=7 and set L01 as below:

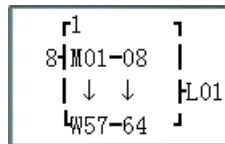

4. Set L01 of the other 7 programs as below;

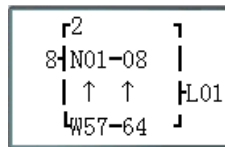

5. Power on and run the program, and control the LRK of ID=7; M01~M08 output ON when I01 is ON;
6. Observe the other 7 LRK, and check output status of N01~N08 is consistent with status of M01~M0 with ID=7.

MU instructions (Modbus communication master function)

Modbus block of micro-plc type LRK20RD024RS realizes Modbus RTU master communication through RS485 interface. In Ladder programming mode, there are 15 Modbus blocks (MU01~MU0F); in FBD programming mode, 250 Modbus blocks can be used at most.

Multiple communication instructions may be used in a program, but only one instruction can be driven at the same time. For example, when multiple Modbus instructions are used and enabled, only one instruction utilizes serial port for execution of its function (coil B outputs ON in FBD mode), while the other Modbus instructions keep the enabled state but do not execute function, namely the other instructions enter the execution waiting state (coil B outputs OFF in FBD mode). When the Modbus instruction utilizing serial port is disabled and releases the serial port after the end of an instruction cycle, the other enabled Modbus instructions begin to preempt the serial port.

Hardware setting:

1. Connect A and B lines of LRK20RD024RS with other Modbus slave, as shown below

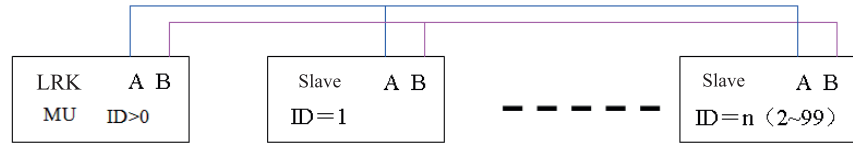

2. Set the Remote I/O option under LRK SET menu as N (No remote I/O);
3. Set the ID SET menu under LRK SET menu as 01~99 (not 00).

ID SET	01
REMOTE I/O	N
BACKLIGHT	x
M KEEP	✓

Comparison table of Modbus mode and communication function code:

Mode	Function code
1	03 (read register)
2	06 (write a single register)
3	10 (write various registers)
4	01 (read coil)
5	05 (write a single coil)

Contacts used during execution of Modbus instructions:

Receiving completed M3D	After completion of receiving, M3D is set for error checking, and the received data is sent to the designated register if no error is found
Error indication M3E	Communication error indication
Timeout judgment M3F	Enter the receiving waiting state after completion of sending; when timeout is determined as no data is received within the specified time period, the timeout output flag M3F is ON, receiving is ended and M3D outputs ON; M3F is automatically reset at the time of M3D resetting.

Timeout judgment and time-out period are determined by baud rate.

Baud rate (bps)	Timeout (ms)
4800, 9600, 19200, 38400	125
57600	100
115200	80

In Ladder mode, Modbus block has 5 parameters, the display and meaning of which are listed below.

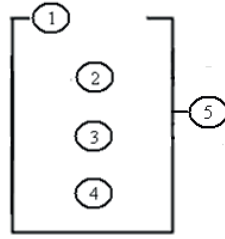

Symbol	Description
①	MU block mode 1~5
②	Communication address: Slave ID, range 0~7f
③	Communication command address and communication data length: 1) Constant, range 0000~ffff; Data length of modes 1 and 3 is 1 word; Data length of mode 4 is 16 bits; 2) DR number, command address and length being stored from the DR
④	DR number, data sent/received being stored from the DR
⑤	MU code (MU01~MU0F)

Refer to Chapter IV: Ladder Programming Instructions-MU (Modbus) Instructions (for LRK20RD024RS type only) for examples of the function.
* The maximum communication data length of modes 1 and 3 is 25 words, and that of mode 4 is 400 bits.

Programming, functional block and parameter display in FBD mode

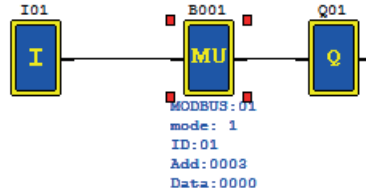

MU Function

Function Mode: 1 MU Number: 01

Read Register (0x03)

485 TCP/IP

Remote ID: 01 (0~7F) Read single register

Comm. add: 0003 (0~FFFF)

DR 01

Comm. data: DR E0

Data will be stored in DR01.

Symbol: _____

OK Cancel

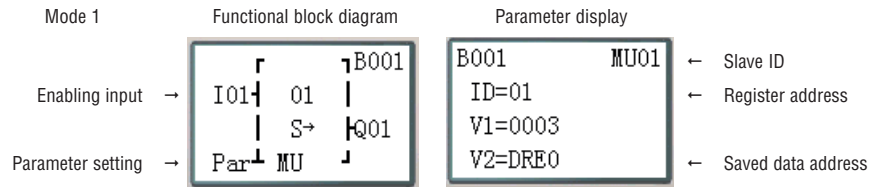

Refer to Chapter V: FBD Programming Instructions- Modbus block Diagram for examples of the function.
* The maximum communication data length of modes 1 and 3 is 25 words, and that of mode 4 is 400 bits.

Modbus communication slave function

Function description:

According to Modbus communication protocol, LRK, as Modbus communication slave, supports reading and writing coil status, reading the current value of functional blocks, writing and reading the preset value of blocks, and control of running and stop status of LRK. The maximum transmission capacity is 128 bytes.

Hardware setting:

1. Connect A and B lines of multiple LRK20RD024RS, and connect to Modbus communication master, as shown below

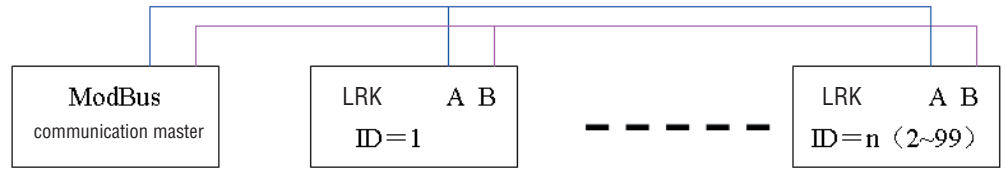

2. Set the Remote I/O option under LRK SET menu as N (No remote I/O);
3. Set the ID SET option under LRK Set menu as 01~99 (not 00).

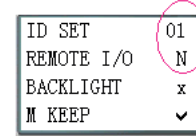

ModBus communication protocol

When LRK receives the correct command format from upper computer or computer, LRK will execute the command. After processing, LRK will send the correct format back to the upper computer or computer. In case of abnormal content or unallowable command, LRK will send a response format to the upper computer or computer.

• Command format and response format:

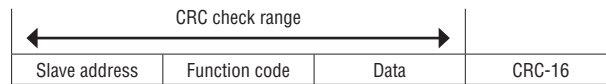

• Exception response format:

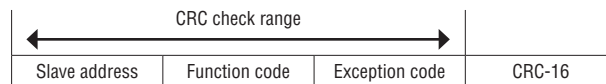

Description:

Slave address	Function code	Data	CRC-16 check	Exception code
00H: All slaves broadcasting	A.	01H: read coil	CRC check range covers slave address, function code and data/exception code	Refer to exception code description
01H: No. 1 slave	B.	05H: write a single coil		
0FH: No. 15 slave	C.	03H: read register		
10H: No. 16 slave	D.	06H: write single registers		
....	E.	10H: write various registers		
063H: No. 99 slave	F.	08H: diagnosis		

Note: The receiving response time on the master computer side (timeout) should be the time of communication command of the maximum 128 bytes (based on baud rate) plus the waiting time of PLC scanning cycle.

Exception code

In case of exception during online communication, the upper computer will send the function code followed by 80H (final bit set as 1) to the master system together with exception code.

Exception code	Description
51H	Communication command error (function code error, invalid data address, parity error etc.)
52H	Communication command error in the Run mode
53H	Communication command error in the Password mode
54H	Invalid data
55H	Reserved
56H	Reserved
57H	LRK other errors
58H	LRK editing mode (Ladder/FBD) error
59H	Reserved

Register address

Register address	Function	Available function code	
0000H-0016H	Coil (word) status	03H, 06H, 10H	LRK New register address
0100H-012FH	Control command	03H, 06H, 10H	
0200H-0237H 0260H	Current value of register	03H	
0300H-033BH	User-defined character	03H, 10H	
0400H-043EH	Preset value of register	03H, 10H	
0500H-05FFH	Coil (bit) status	01H, 05H	
0600H-0630H	Coil (word) status	03H, 06H, 10H	
0700H-072FH	Control command	03H, 06H, 10H	
0800H-11EFH	Current value of register	03H	
1200H-2703H	Preset value of register	03H, 06H, 10H	
2B00H-2E0FH	Coil (bit) status	01H, 05H	

For details about Modbus protocol refer to the Modbus manual I196, downloadable from the website www.LovatoElectric.com.

Chapter 9 Extended Module Instructions

Chapter 9 Extended Module Instructions	195
Overview	196
Extended Digital IO Modules	198
Extended Analog Modules	202
Analog input module 4AI	202
Temperature input module 4PT	203
Analog output module 2AO	204
Extended Communication Module	206
RS485 Modbus RTU module.	206

OVERVIEW

LRK base module is compatible with the expansion modules LRE series, listed below.
The connection mode of LRK expansion module is the same as that of LRD expansion module.

Digital inputs and outputs expansion modules:

- LRE08RD024 (4 digital inputs + 4 relay outputs, auxiliary supply 24VDC)
- LRE08TD024 (4 digital inputs + 4 transistor outputs, auxiliary supply 24VDC)
- LRE08RA024 (4 digital inputs + 4 relay outputs, auxiliary supply 24VAC)
- LRE08RA240 (4 digital inputs + 4 relay outputs, auxiliary supply 100...240VAC)

Analog inputs and outputs expansion modules:

- LRE04AD024 (4 analog inputs 0...10VDC/0...20mA, auxiliary supply 24VDC)
- LRE02AD024 (2 analog outputs 0...10VDC/0...20mA, auxiliary supply 24VDC)
- LRE04PD024 (4 PT100 temperature inputs, auxiliary supply 24VDC)

Communication expansion modules:

- LREP00: RS485 Modbus-RTU communication module, auxiliary supply 24VDC.

Maximum combination

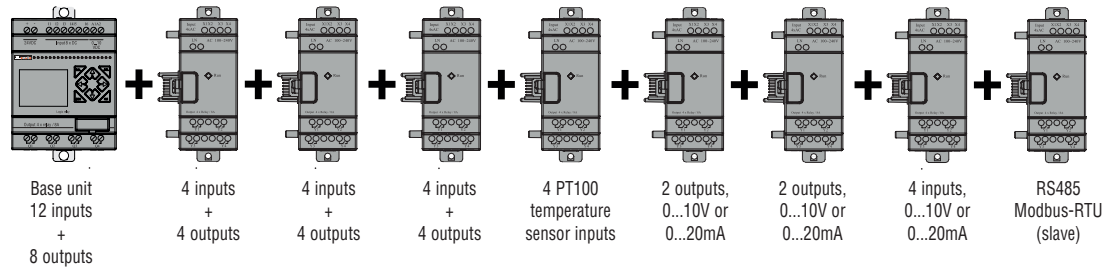

- 24 digital inputs (4 configurable as analog 0...10Vinput)
- 20 digital outputs (relay, transistor or mixed)
- 4 analog inputs for PT100 temperature sensors
- 4 analog outputs configurable as 0...10V or 0/4...20mA
- 4 analog inputs configurable as 0...10V or 0/4...20mA
- 1 RS485communication module.

N.B. The sequence and the maximum number of the products given above must be respected for correct operation.

LRK can be connected to the extended modules (up to 3 digital I/O modules); specifically, the types can be connected to three groups of digital I/O module, or two groups of analog output module, or two groups of analog input module (one 4PT and one 4AI) and one group of communication module at the maximum. LRK should be connected to the extended modules in the order of digital module, analog module and communication module.

* The connection mode of LRK expansion module is the same as that of LRD

* 4AI must be placed behind analog module and in front of communication module;

1. If digital I/O is connected with other expansion module, the IO NUMBER setting in the SET menu of LRK base module should be consistent with actual number of extended digital I/O modules connected; if digital I/O is not connected with other expansion module, the IO NUMBER setting in the SET menu of LRK basic unit should be less than or equal to actual number of extended digital I/O modules connected, and the set number of extended digital I/O modules should work.

Expansion module	Add single module Influence	Max connecting num	Max influence to scanning cycle
Digital I/O module	scanning cycle +1ms	3	+1 ms*3=3ms
4PT module	scanning cycle +7ms	1	+7 ms*1=7ms
2AO module	scanning cycle +8ms	2	+8 ms*2=16ms
4AI module	scanning cycle +13ms	1	+13ms*1=13ms
Communication module	scanning cycle +4~16ms	3	+4~16ms*3=12~48ms

2. The scanning cycle of LRK is 2-20ms, which will be extended if extended modules are connected; specifically, the cycle will be extended by 1ms per digital I/O, by 7ms per 4PT module, by 8ms per 2AO module, by 13ms per 4AI module and by 4-16ms per communication module. In addition, the scanning cycle will be extended by about 100ms when the preset value of LRK functional block is modified by communication module.
3. 4PT data of one channel is updated in each host scanning cycle, and data of 4 channels is updated after 4 host scanning cycles.

For details about LRE expansion modules refer to the instruction manual of the micro-plc LRD series I185, downloadable from the website www.lovatoelectric.com.

INSTALLATION

The installation method of all LRE expansion modules is the same, modules are connected to each other via connectors as shown below:

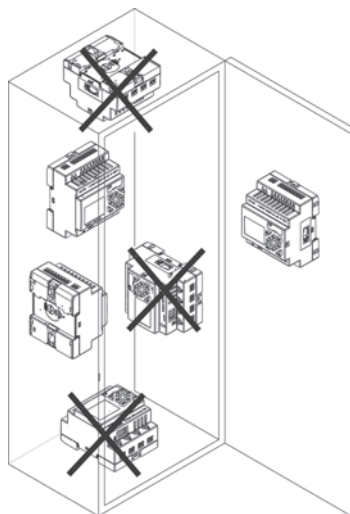
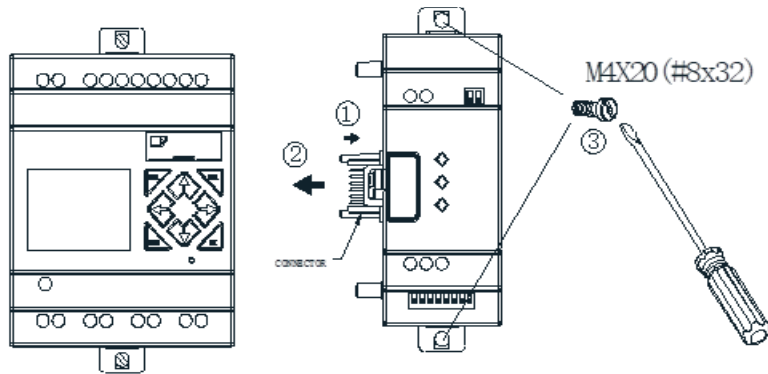
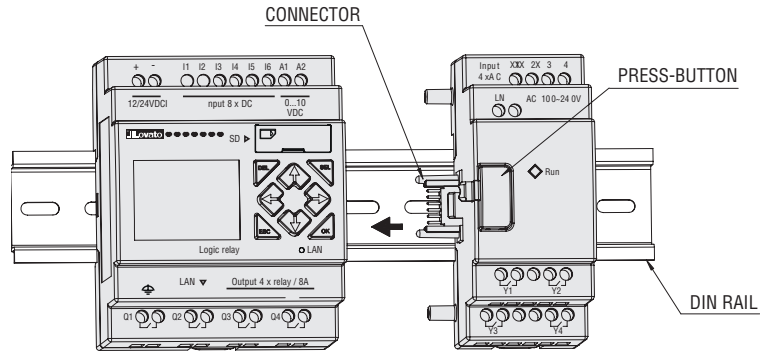
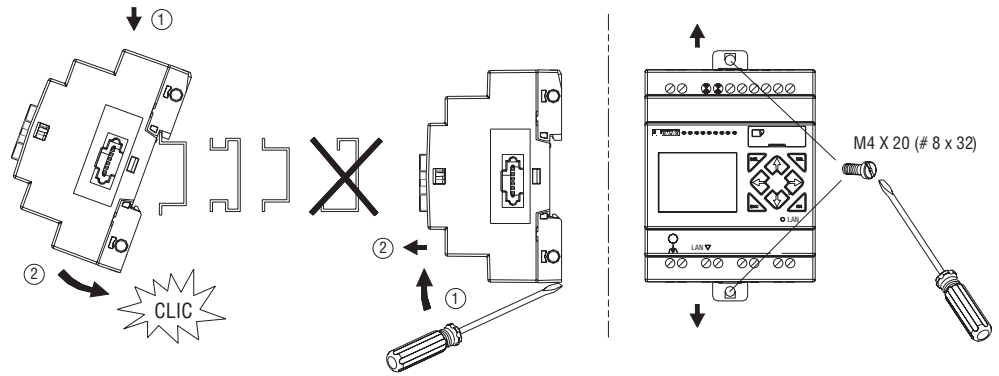

Wire specification: 14AWG/0.8Nm
 Danger:
 Please turn off power prior to equipment maintenance.
 Electric shock may cause personal injury and death.

EXTENDED DIGITAL IO MODULES

The number of extended digital IO modules connected should be set in the system. In case of setting error, the extended digital IO modules can not be used normally, and use of the connected analog modules and communication modules will be affected.

Setting method of extended IO:

1. Key setting menu:

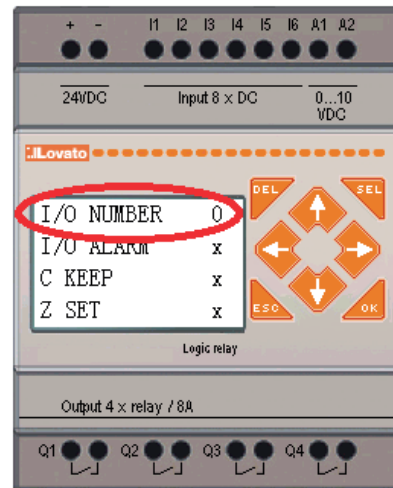

2. LRXSW setting menu:

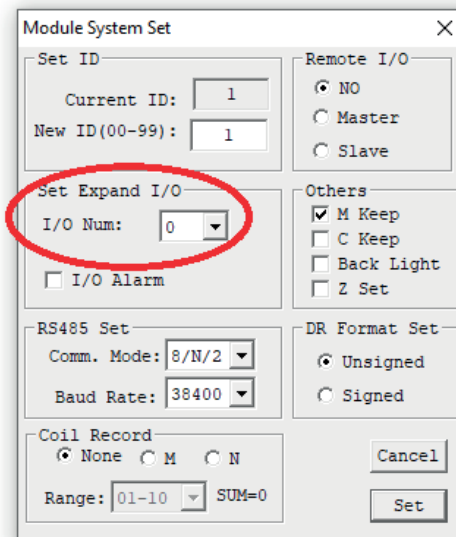

Display status of digital IO extension

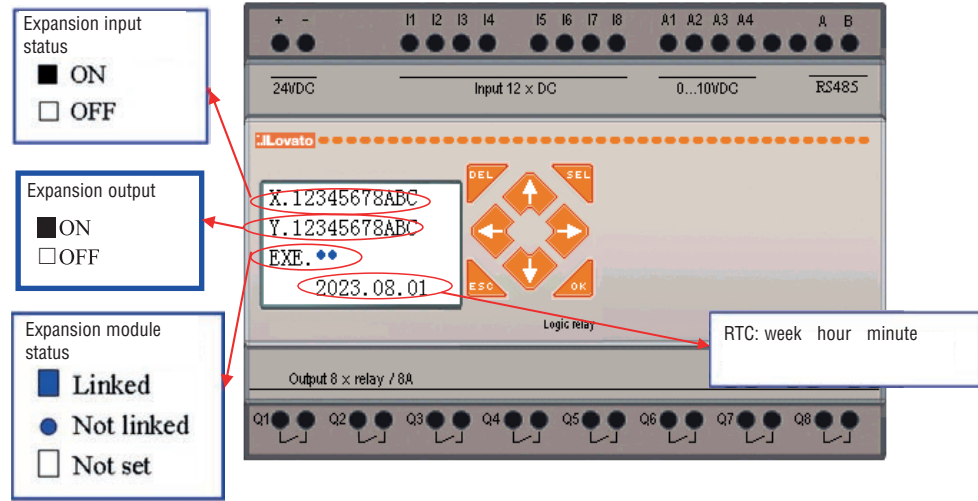

Installation and wiring
 LRE08RD024
 LRE08TD024
 LRE08RA240

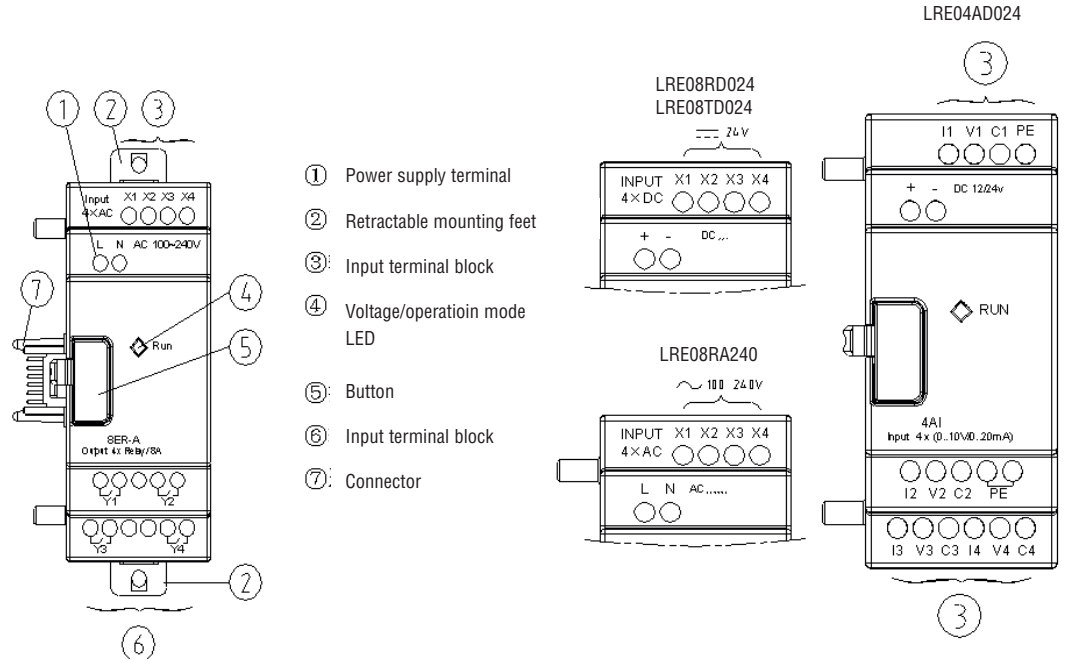

Wiring

1) Input 24VDC: LRE08RD024 / LRE08TD024

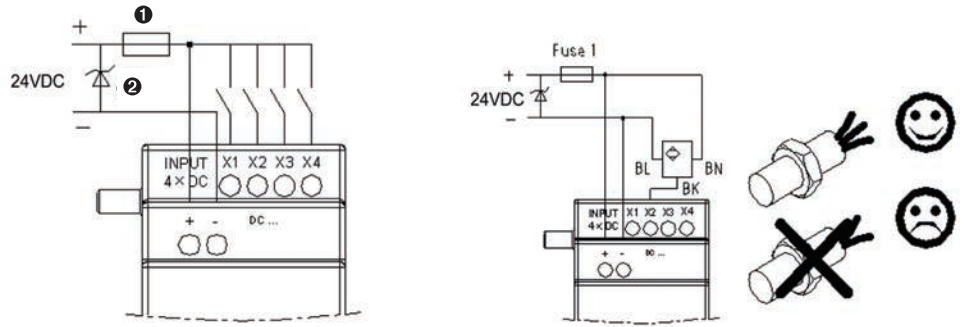

2) Input 24VAC/100-240VAC: LRE08RA024 / LRE08RA240

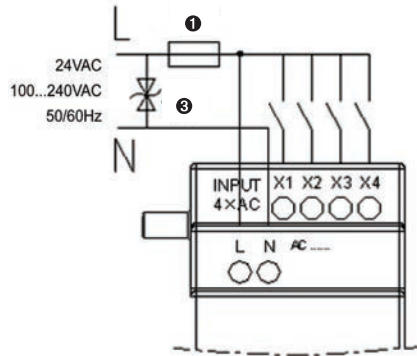

Output relay (Relay): LRE08R...

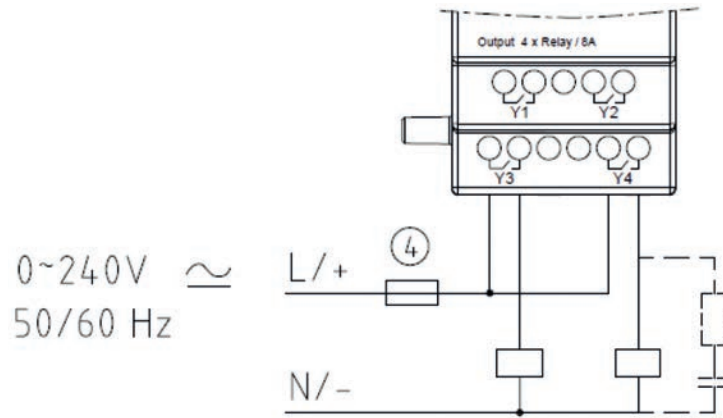

3) Output transistor (Transistor):

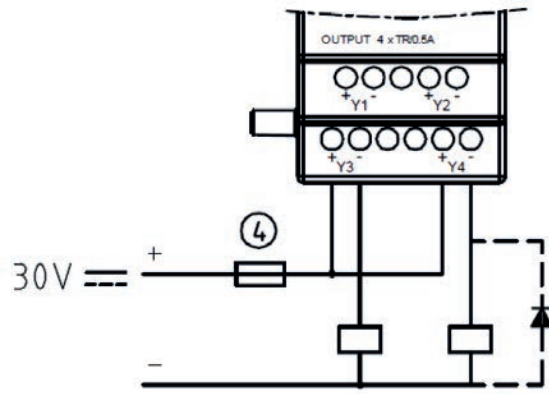

- ① -1A fast acting fuse
- ② -Surge arrester (cut-off voltage: 43VDC)
- ③ - Surge arrester (input 100-240VAC, cut-off voltage:430VAC)
- ④ -Fuse

Both extended digital module and extended analog module are designed with orange status LED, the display status of which is the same in different operating modes, as shown below:

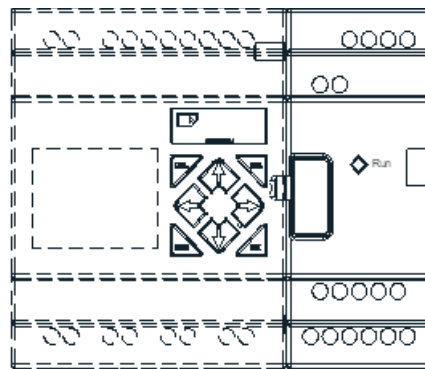

◆	Extended module in running state
⚡	Quick flashing (3Hz), extended module in fault state - Data transfer error - Previous connection error

EXTENDED ANALOG MODULES

LRK can be simultaneously connected to two 2AO module, one 4PT module and one 4AI module at most.

ANALOG INPUT MODULE 4AI: LRE04AD024

This is 4-channel 12bits analog input module with input corresponding to A05-A08, which is available for input of 0-10V voltage signal or 0-20mA current signal. The 12bit value 0-4095 is stored in register DREC-DREF. When 0-20mA current is input into A05-A08, the corresponding value (0-2000) is stored in DRE4-DRE7.

Item	Specification	
	Voltage	Current
Mode	Voltage	Current
Analog input range	0V-10V	0mA-20mA
Resolution	10mV	40μA
Digital display	0.00V-9.99V	0.00mA-20.00mA
Corresponding register value	A05-A08	0-999
	DREC-DREF	0-4095
	DRE4-DRE7	0-2047
Accuracy	±2.5%	±2.5%

Current value display of 4AI input:

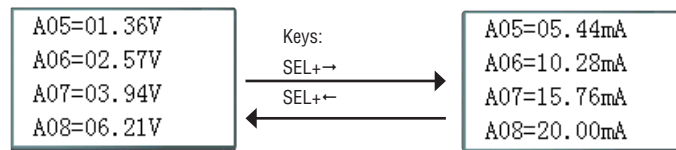

Wiring

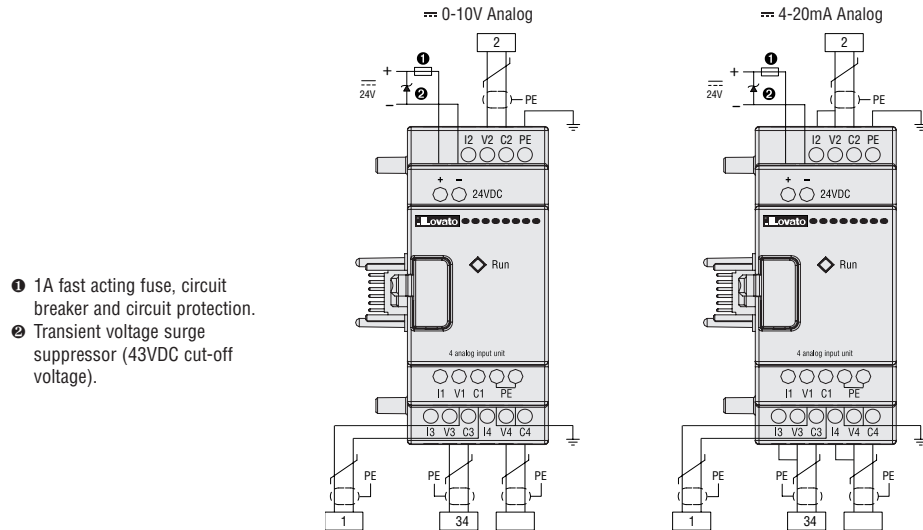

- ❶ 1A fast acting fuse, circuit breaker and circuit protection.
- ❷ Transient voltage surge suppressor (43VDC cut-off voltage).

TEMPERATURE INPUT MODULE 4PT: LRE04PD024

This is 4-channel 12bits temperature (PT100) analog input module with input corresponding to AT01~AT04, which is available for input of -100°C~600°C signal.

Item	Specification
Temperature input range	-100°C~600°C
Digital display	-100.0°C~600.0°C
Resolution	0.1°C
Accuracy	±1%

4PT wiring error or lack of connection will lead to input out of range. In this case, LRK does not receive the AT channel corresponding to the temperature, and coil M of the corresponding channel is set ON.

M coil	AT No.	
M34	AT01	4PT channel I error flag
M35	AT02	4PT channel II error flag
M36	AT03	4PT channel III error flag
M37	AT04	4PT channel IV error flag

Current value display of 4PT input:

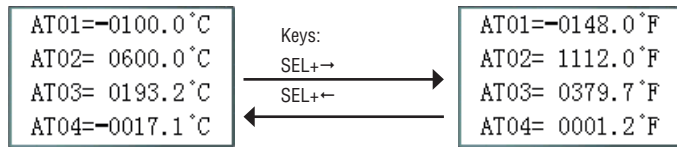

Wiring

- ❶ 1A fast acting fuse, circuit breaker and circuit protection.
- ❷ Transient voltage surge suppressor (43VDC cut-off voltage).

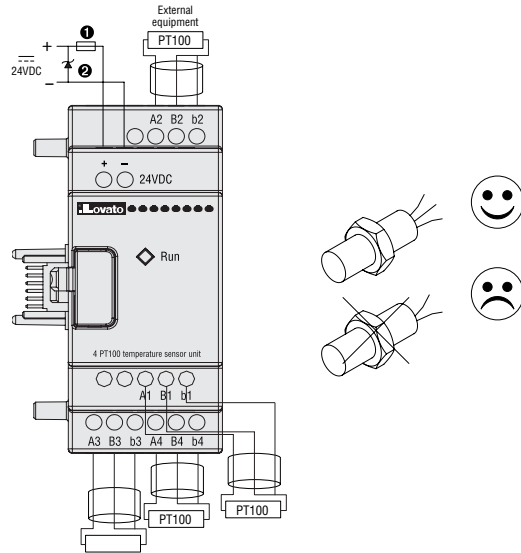

ANALOG OUTPUT MODULE 2AO: LRE02AD024

This is 2-channel 12bits analog output module. Two of the modules can be connected at the same time. Output of the 2AO close to LRK corresponds to AQ01~AQ02, and output of the second 2AO corresponds to AQ03~AQ04. The module enables output of 0~10V voltage signal or 0~20mA current signal. The 12bit value 0~4095 is stored in register DRD4~DRD7.

Item	Specification	
Analog output range	0V~10V External impedance over 500Ω	0mA~20mA External impedance below 500Ω
Resolution	10mV	40μA
Digital output	0.00V~10.00V	0.00mA~20.00mA
Corresponding register value	AQ01~AQ04	0~1000
	DRD4~DRD7	0~4095
Accuracy	±2.5%	±2.5%

Output mode depends on the current value of register DRD0~DRD3, as listed below.

	Output register	Mode register	Mode	DRD0~DRD3 data definition
Channel 1: AQ01	DRD4	DRD0	1	0: voltage mode, AQ output value 0 in STOP mode
Channel 2: AQ02	DRD5	DRD1	2	1: current mode, AQ output value 0 in STOP mode
Channel 3: AQ03	DRD6	DRD2	3	2: voltage mode, AQ output value kept in STOP mode
Channel 4: AQ04	DRD7	DRD3	4	3: current mode, AQ output value kept in STOP mode

AQ DISPLAY

The preset value (constant or code of other data type) is displayed by AQ in STOP mode, and current value displayed in RUN mode.

Display in STOP mode

```
AQ01=09.77V
AQ02=20.00mA
AQ03= A01 V
AQ04=DR3F mA
```

Display in RUN mode

```
AQ01=09.77V
AQ02=20.00mA
AQ03=02.10V
AQ04=00.00mA
```

When AQ output mode is the current mode, the correspondence of DR value, AQ current value and displayed value is as follows:
DRD5 current value=2047, corresponding AQ02=500, displayed value: 20.00mA.

- * When the preset value type of AQ is constant, the corresponding DR value changes, and AQ output value is modified accordingly ($AQx=DRx/4.095$);
- * When the preset value type of AQ is set as other parameter variable, DR value varies with AQ ($DRx=AQx*4.095$);
- * Refer to Chapter IV: Ladder Programming Instructions-AQ Analog Output Instructions for the correspondence of AQ and DR.

Wiring

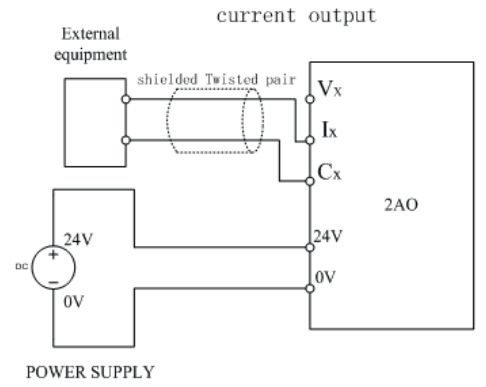
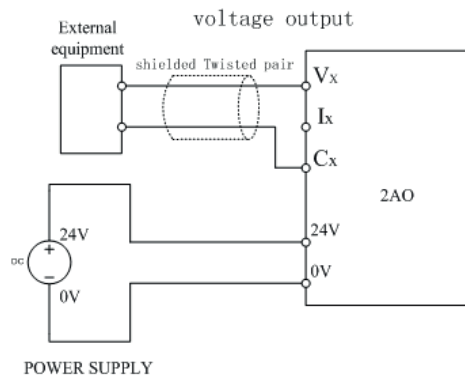
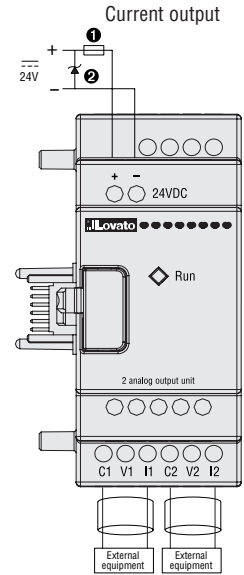
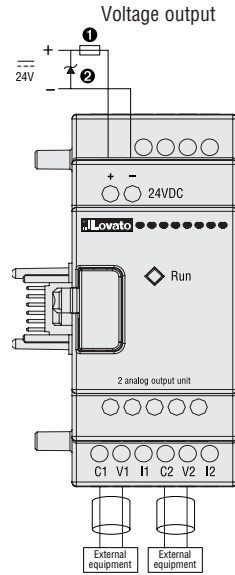

COMMUNICATION MODULE

Extended RS485 Modbus RTU module: LREP00

System overview

LREP00 communication module makes LRK micro-plc without communication function able to communicate with other controllers in the master/slave mode according to Modbus RTU protocol, for application to auto control system for industrial bus.

LREP00 communication module uses passive slave node of Modbus RTU transmission mode. It can respond to request of Modbus RTU master, but it cannot actively initiate communication.

The module is connected with LRK micro-plc base module and PLC/HMI/PC master to form a simple bus communication system based on RS485 Modbus communication protocol.

The module extends the scanning cycle of LRK basic unit. The extended time varies with communication command, and it is generally within 20ms; however, modification of the preset value of LRK functional block will cause the scanning cycle to be extended by 100ms. Please take this factor into consideration for calculation of response time.

LREP00 communication module structure

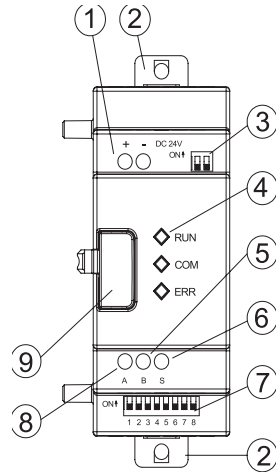

- ① - 24VDC Power supply
- ② - 35mm DIN rail clip or screw fixing using M4x15mm type.
- ③ - 2-bit switch SW2 (terminal resistance selection with both at ON)
- ④ - Status LEDs - RUN (running), ERR (error), COM (communication)
- ⑤ - RS485 serial port – B terminal
- ⑥ - RS485 serial port - Screen
- ⑦ - 8-bit dip-switch for communication data frame format setting
- ⑧ - RS485 serial port – A terminal
- ⑨ - Expansion release button

Power connection 24VDC

input power

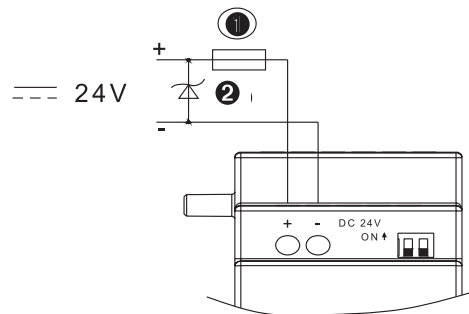

- ① - 1A fast acting fuse
- ② - Transient voltage surge suppressor (43VDC cut-off voltage).

Communication setting

In LREP00 communication module, 8-bit dip switch (DIP) SW1 can be used to set communication baud rate, parity check bit and stop bit, as instructed below:

Baud rate setting

SW1-1~SW1-3, for setting communication baud rate: 4.8K, 9.6K, 19.2K, 38.4K, 57.6K

SW1-1	SW1-2	SW1-3	SW1-6	Baud rate (Kbps)
OFF	OFF	OFF	OFF	4.8
ON	OFF	OFF	OFF	9.6
OFF	ON	OFF	OFF	19.2
ON	ON	OFF	OFF	38.4
*	*	ON	OFF	57.6
*	*	*	ON	38.4

* may be OFF or ON

Check bit and stop bit setting

SW1-4~ SW1-5, for setting stop bit and check bit SW1-6, for combined setting

SW1-7 SW1-8, reserved

SW1-4	SW1-5	SW1-6	SW1-7	SW1-8	Stop bit, parity check bit and combined setting
OFF	OFF	OFF	*	*	2 stop bits, no parity check bit
OFF	ON	OFF	*	*	1 stop bit, no parity check bit
ON	OFF	OFF	*	*	1 stop bit, 1 odd parity bit
ON	ON	OFF	*	*	1 stop bit, 1 even parity bit
*	*	ON	*	*	Default communication format being baud rate 38400bps, 2 stop bits and no check bit if SW1-1~SW1-5 setting is invalid

* may be OFF or ON

Address setting

LREP00 module ID is the same with ID of the connected LRK micro-plc base module. The allowable address range is 0 63H, wherein 0 is the broadcast address. After LRK host ID is modified, the communication module ID is automatically acquired or updated after power-on or 0.5s after no Modbus command is received during operation.

LED status display

Communication return of error code	Status indication	Error type and cause	Solutions	Remarks
56H	Power status LED of communication module flashes (2Hz)	LRK and communication module improperly connected	Check LRK connection with extended I/O module and communication module	The connection between the module with flashing LED and the previous module is faulty in case of various extensions
55H	Error LED of communication module is lit	LRK setting error: Number of I/O modules under LRK system menu inconsistent with actual number of I/O modules connected	Check LRK setting	
51H 54H	Error LED flashes slowly (2Hz)	Modbus command error: Improper data frame, function code, register address, CRC check and data, parity check error and other errors	Check the command is proper and communication setting is correct in reference to the protocol	
59H	Error LED flashes quickly (5Hz)	Wrong data during communication between extended module and LRK: odd parity error, or error in returned data length and CRC check	Check communication module and LRK host are connected reliably to reduce interference of ambient environment	

For details about Modbus protocol refer to the Modbus manual of the LREP00 module I196, downloadable from the website www.lovatoelectric.com.

Chapter 10 External Memory

Chapter 10 External Memory	208
User program reading and writing with micro SD card	209
Data logging function	210
Card formatting	211
Configuration file reading	212

EXTERNAL MEMORY

LRK support a micro SD card as external memory for program backup and data logging:

1. User programming reading and writing: Read and write SD card to duplicate user program by three means (keypad and display, PC, and LRK power-on automatic operation).
2. Data logging and output: LRK enables to write user program for data logging and storage in SD card as required.
3. Card formatting: LRK only supports micro SD card of FAT32 file system format for storage of program; memory card of other format should be formatted as FAT32 before operation.
4. Configuration file reading and writing: LRXSW is used for reading configuration files in SD card and reconfiguration of LRK (IP address and gateway etc.).

Note. LRK only supports micro SD card of standard capacity and standard SDHS card of high capacity. The maximum card capacity is 32GB.

USER PROGRAM READING AND WRITING WITH SD CARD

1. User program writing from SD card into LRK by keypad operation

For the micro-plc with LCD display (types LRK..., not LRK...B), the keypad can be used for SD card operation. Select "CARD-> PLC" in the main menu to enter secondary menu where status of the current SD card is displayed. When there is SD card, press "OK" to transfer user program in memory card LRK. The current status of memory card is displayed in the corresponding submenu:

- a. Whether card is detected in the slot
- b. Current remaining capacity of card

```
CLEAR PROGRAM
PLC->CARD
>CARD-> PLC
SET
```

```
CARD -> PLC
DISK: 29714MB
>Yes
No
```

Notes

- It is allowed to use card to write user program in LRK only when LRK is stopped.
- In case of power failure during user program duplication in LRK, please repeat the process after power recovery.

2. User program writing from LRK into SD card by key operation

Use the type with LCD display and key function, select "PLC->CARD" in the main menu to enter secondary menu where status of the current SD card is displayed; when there is SD card, press "OK" to transfer user program in LRK into memory card.

```
CLEAR PROGRAM
>SG3->CARD
CARD-> PLC
SET
```

```
PLC->CARD
DISK:
29714MB >Yes
No
```

Notes:

- In case of power failure during user program duplication in LRK, please repeat the process after power recovery.
- The protected password in LRK is similarly valid for program in the card.
- LRK allows storage of one user program in the memory only. To modify circuit program or create the second program while the first one is not deleted, please save the program in other memory in advance.

3. SD card operation with PC and software LRXSW

For micro-plc type LRK...B without screen key, the PC with software LRXSW can be used for operation of SD card.

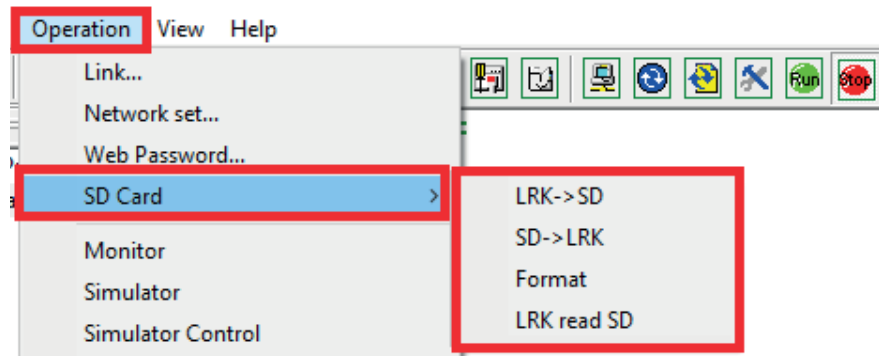

Notes:

- It is allowed to use card to write user program in LRK only when LRK is stopped.
- In case of power failure during user program duplication in LRK, please repeat the process after power recovery.

DATA LOGGING FUNCTION

1. Data logging

As shown below, the data logging function is configured.

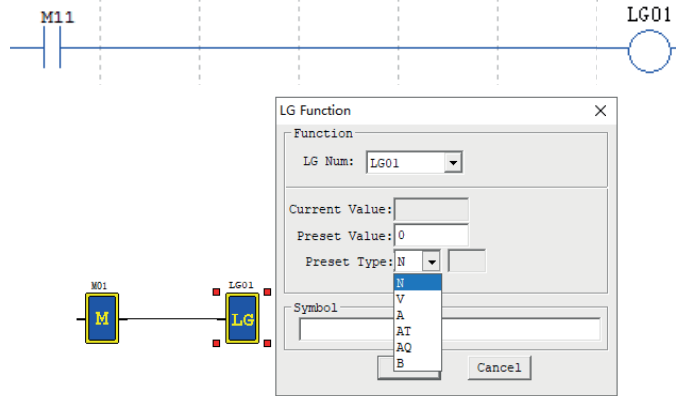

LOG can be used for recording of the selected parameters. In the above program, value of the set target register T1 is stored in LRK or micro SD card after coil M11 is enabled; LRK will record the set parameters in each scanning cycle after M11 is enabled. As high rate may lead to data loss, the combined use of timer (T) function and LOG function is recommended.

LOG can be used for recording of the selected parameters. In the above program, the value of the variable set in LG01 is stored into the micro SD card of the LRK when the M11 is enabled; LRK will record the set parameters in each scanning cycle after M11 is enabled. As high rate may lead to data loss, the combined use of timer (T) function and LOG function is recommended.

Note:

Please apply enabling signal to the data logging block in a time interval no less than 500 ms to avoid data loss. Excessive writing frequency will lead to loss of data.

The following example shows how to properly enable the data logging in a ladder project:

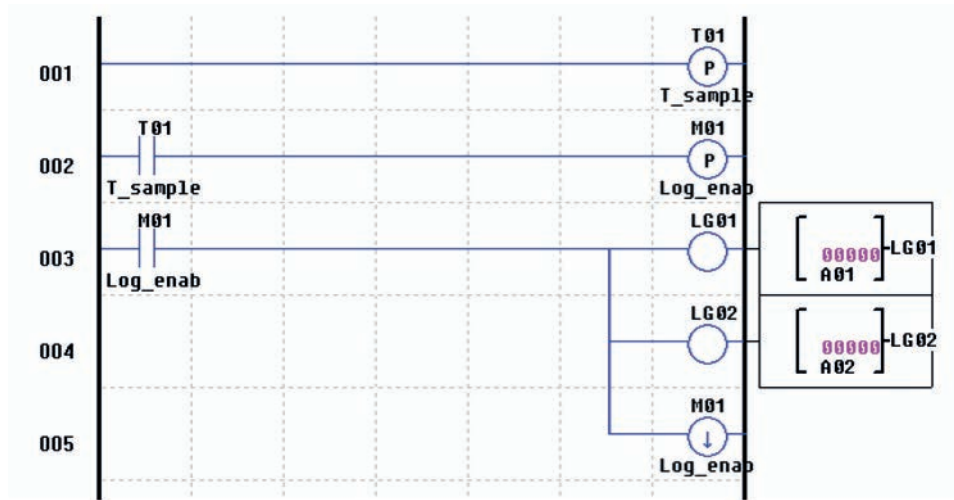

- T01 is a timer in flasher mode which marks the sampling period for the datalog (e.g. to record a value every 10 seconds set Ton=1sec, Toff=9sec).
- The coil T01 controls the coil of the marker M01 (flip-flop mode)
- The marker M01 enable the data-log blocks LG01 (that in this example records the analog input A01) and LG02 that in this example records the analog input A02): every time M01 is activated, a new record of LG01 and LG02 is stored into the SD card memory.

2. Data storage location and format

If you insert the same card into a LRK host module, new data will be stored following the file saved in the current day, but the maximum line number of a file to be saved is limited by the memory size.

1. When the LOG function is used for the first time, LRK will create a folder named EXCEL under the root directory of memory card, which is used for storage of data files logged.

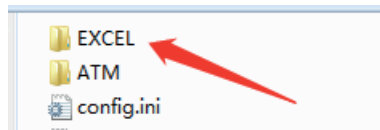

2. Data log file in LRK is named based on the current date (year-month-day). New data entries logged in a same day will be stored in the same file following the previous ones, but will not cover the previous data. The size of data to be stored is limited by free space of memory card.

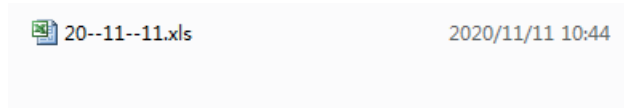

3. File is stored in .xls format by default. You can open the file in PC. Each line in the EXCEL file includes a time point, functional block number and actual value recorded.

	A	B	C
1	Time	Coil_Name	Current_Value
2	24.2.15 9:15:9	A01	11
3	24.2.15 9:15:9	C01	0
4	24.2.15 9:15:9	T05	0
5	24.2.15 9:15:19	A01	11
6	24.2.15 9:15:19	C01	0
7	24.2.15 9:15:19	T05	10
8	24.2.15 9:15:33	A01	11
9	24.2.15 9:15:33	C01	0
10	24.2.15 9:15:33	T05	0

CARD FORMATTING

- 1) LRK only supports micro SD card of FAT32 format for storage of program. A memory card of any other format should be formatted to FAT32 format in advance.
- 2) The "Format card" option under the main menu enables formatting of SD card. Please back up data in the card before formatting, as all data stored in the card will be cleared after formatting.

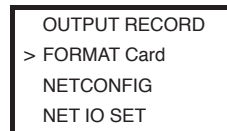

CONFIGURATION FILE READING

For the types without LCD display (type LRK...B), parameter can be setting by reading the configuration file XXX.ini:

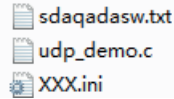

Located under the root directory of SD card, XXX.ini file can be written in the set parameter of LRK (removing the file from the root directory or rewriting the file name will lead to file reading error).

When powered on and put under the STOP state, LRK will read content in the configuration file, and modify the target register as per data in the file.

Use of configuration file

Set IP address

For LRK...B types without screen, IP address can be configured by diary file writing and then reading by SD card.

```
#-----
#SET IP ADDR
#-----
IP_ADDR0 = 010;
IP_ADDR1 = 128;
IP_ADDR2 = 019;
IP_ADDR3 = 246;
```

Open the "XXX.ini" file under root directory of SD card to modify the file content and complete LRK parameter setting. The following rules should be followed for file modification:

1. The set value should be between the punctuation marks "=" and ";".
2. The content behind the symbol "/" is annotation not to be read by LRK.
3. Set "10,128,19,246" as the IP address; divide "10.128.19.246" into four fields, "010", "128", "019" and "246"; then fill the four fields into the corresponding location as shown above.
4. If a field greater than 255 is filled, 255 will be read by LRK by default;
5. Put SD card in LRK, power on again and put it under the STOP state, LRK will automatically read and configure IP address.

Set subnet mask address

For LRK types without screen, subnet mask address can be configured by diary file writing and then reading by SD card.

```
IP_ADDR2 = 019;
IP_ADDR3 = 246;
#-----
#SET SUBNET MASK
#-----
SUB_ADDR0 = 255;
SUB_ADDR1 = 255;
SUB_ADDR2 = 255;
SUB_ADDR3 = 000;
#-----
#SET GATEWAY
```

Open the "XXX.ini" file under root directory of SD card to modify the file content and complete LRK parameter setting. The following rules should be followed for file modification:

1. The set value should be between the punctuation marks "=" and ";".
2. The content behind the symbol "/" is annotation not to be read by LRK.
3. Set "255.255.255.0" as the IP address; divide "255.255.255.0" into four fields, "255", "255", "255" and "000"; then fill the four fields into the corresponding location as shown above.
4. If a field greater than 255 is filled, 255 will be read by LRK by default;
5. Put SD card in LRK, power on again and put it under the STOP state, when LRK will automatically read and configure subnet mask address.

Set gateway address

```
SUB_ADDR0 = 255;
SUB_ADDR1 = 255;
SUB_ADDR2 = 255;
SUB_ADDR3 = 000;
#-----
#SET GATEWAY
#-----
GATE_ADDR0 = 192;
GATE_ADDR1 = 168;
GATE_ADDR2 = 000;
GATE_ADDR3 = 002;
#-----
#SET MASTER IP ADDR
#-----
IP_ADDR0 = 010;
IP_ADDR1 = 128;
IP_ADDR2 = 019;
IP_ADDR3 = 245;
```

Follow the same method of IP address and subnet mask setting for setting gateway address.

Chapter 11 Ethernet Communication Function

Chapter 11 Ethernet Communication Function	213
Overview	214
Device connection	214
LRXSW programming software connection	216
Extended device connection and network block configuration	216
Web server	218
Network communication between two LRK devices	220
Modbus TCP function/Modbus RTU over TCP function	223
E-mail transfer function	227

OVERVIEW

LRK series products support the Ethernet communication function. User can realize the following functions through Ethernet communication:

- User program reading, writing and monitoring
- Extended device connection and network functional block configuration Network server
- Device program upgrade

DEVICE CONNECTION

The module is designed with an Ethernet RJ45 interface and a network status LED.

The shielded twisted-pair Ethernet cable can be used to connect device with PC, router, switch or other extended devices with RJ45 network interface;

Network status LED indicates whether network communication of device is normal, which is off when network is disconnected, and the green LED is lit during normal network connection; the LED flashing frequency is an indicator of network communication status.

Device connection:

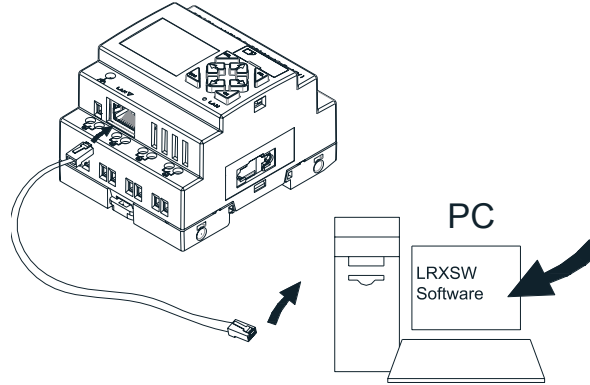

Network information setting

The LCD interface of LRK shows the device IP address, Subnet mask, Gateway address, master/slave working mode, as well as remote master IP address, IAP upgrade flag and other functions in the slave mode. The selected information can be modified by keypad.

Press the direction key to page up/down , select "NETCONFIG" under the main menu.

```

OUTPUT RECORD
FORMAT Card
> NETCONFIG
NET IO SET
  
```

Press OK to enter "NETCONFIG"

```

> IP ADDRESS
SUBNET MASK
GATEWAY
MASTER IP
  
```

```

> GATEWAY
MASTER IP
LAP SET
NET SET
  
```

Select the corresponding option under "Network setting" (NETCONFIG), and press "OK".

Set IP address: Press "SEL" to enter the editing mode, and press "↑" "↓" for digit selection.

-> IP ADDRESS ->

```

IP ADDRESS
192.168.000.003
  
```

Set subnet mask:

-> SUBNET MASK ->

```

SUBNET MASK
255.255.255.000
  
```

Set gateway address:

-> GATEWAY ->

```

GATEWAY
192.168.000.001
  
```

Set master IP:
-> MASTER IP ->

MASTER IP 192.169.000.005

IAP upgrade setting:

IAP SET Yes No

Network communication Master/slave station setting:
-> M/S SET ->

M/S SET	M
---------	---

After setting all , press "ESC" to return to the NETCONFIG menu(this time will not save your settings to flash), press "ESC" to return to the main menu when LRK automatically save the network settings.

LRXSW PROGRAMMING SOFTWARE CONNECTION

After communication network connection of device and PC, open editing environment.

LRXSW, and enter Ladder or FBD program

Right click "Station" under the project, and select the "Link" item popped up.

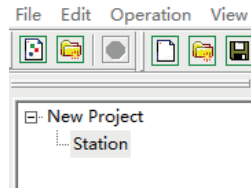

The "Select communication port" window pops up, as shown below:

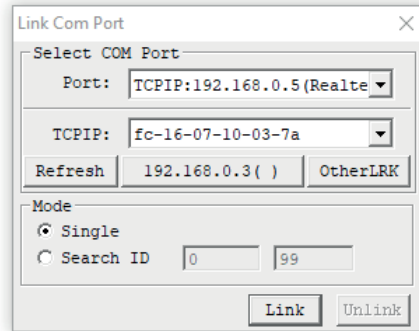

Note: Modify IP address of PC and device in the same network segment.

Select MAC address of the LRK to be linked, and click "Link", when LRXSW will be automatically connected with LRK micro-plc.

EXTENDED DEVICE CONNECTION AND NETWORK BLOCK CONFIGURATION

Complete network information setting of device and communication configuration of network input and output ports after the upper computer is linked.

Upper computer menu bar: "Operation" → "Network Set"; enter the Network Set window.

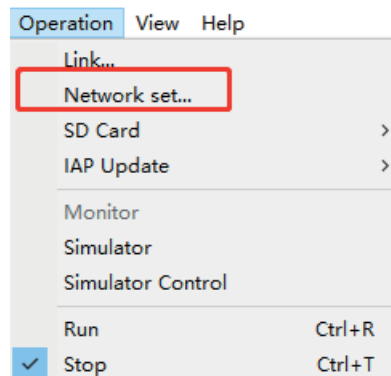

"Local setting" Set the device IP address, subnet mask, gateway address, remote master IP address and Master address in the device setting bar. When LRK is in STOP mode.

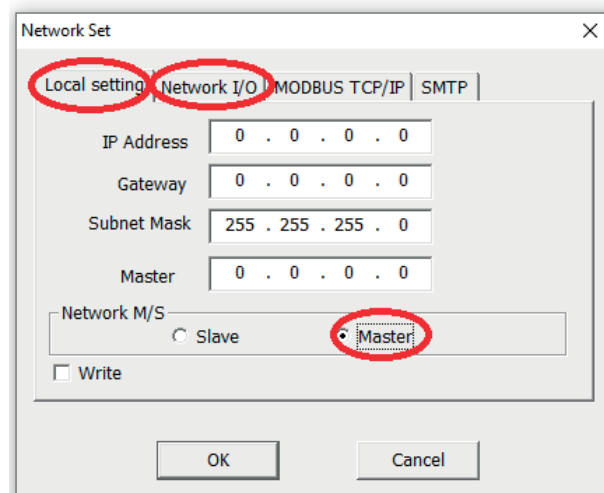

Inputs and outputs function:

LRK provides network digital inputs/outputs and network analog inputs/outputs.

The LRK master can communicate with the LRK slave using the network inputs and outputs.

Blocks	Function	Number
J01 ~ J3F	Network digital inputs	63
K01 ~ K3F	Network digital outputs	63
NI01 ~ NI1F	Network analog inputs	31
NQ01 ~ NQ0F	Network analog outputs	15

Complete network configuration of network input and output ports of the master device in the Network I/O bar.

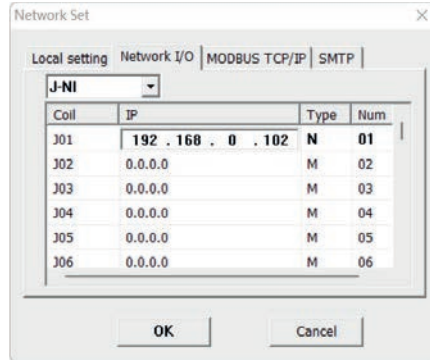

As shown above, network digital input port J01 reads status of point N01 of slave device 192.168.0.102.

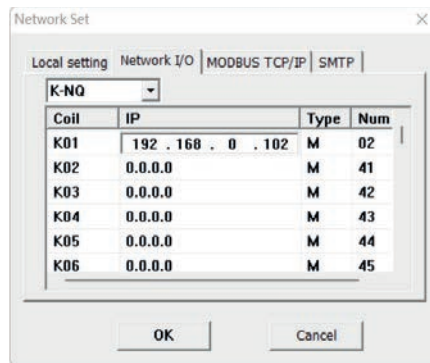

As shown above, status of network digital output port K01 is output to point M02 of slave device 192.168.0.102.

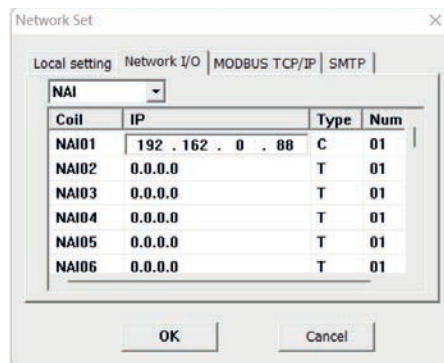

As shown above, network analog input port NAI01 reads the value of C01 of slave device 192.168.0.88.

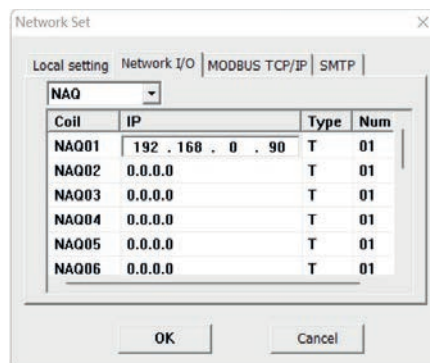

As shown above, the value of network digital output port NAQ01 is output to T01 of slave device 192.168.0.90.

WEB SERVER

LRK micro-plc are designed with the web server function to enable the view of the main LRK information and status through a PC or mobile device in the network.

Web server credentials

The first time you want to use the web server of LRK, a password must be set in the project. Open the software LRXSW and connect to the LRK. Then, clic on Operation -> Web Password.

Clicking on Clear -> OK, the web server credentials are reset to default settings (admin: admin, password: admin). Otherwise, it is possible to set a new admin name and a new password, then press OK. A message will confirm Write OK.

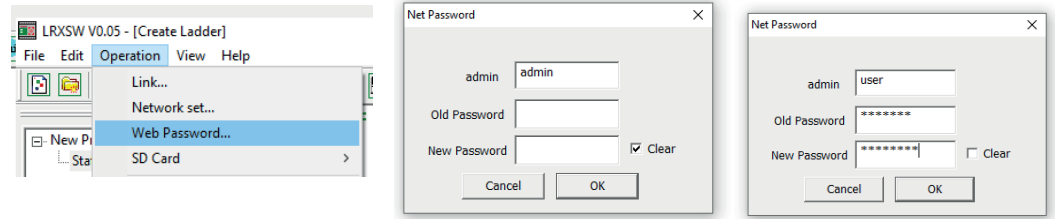

Web server access

Open the browser, enter the IP address of the LRK device in the address bar and the LRK web server page will appear. Insert the credentials (user and password) of the LRK web server and clic on Login to access to the web server to check device information and working state.

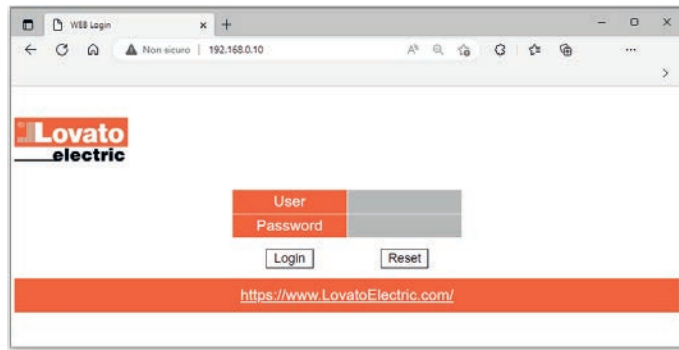

System page: Display of the micro-plc model and versions information:

SYSTEM	IO Status	Setting
Device Series	LRK20	
Device Type	RD024RS	
FW Version	V0.30	
IP Address	192.168.000.010	
Status	STOP	
RTC	01.01.21 01:20 Fri	

<https://www.LovatoElectric.com/>

IO status page: View device working state information: digital and analog inputs and outputs, timers, counter, etc...

Lovato electric

SYSTEM		IO Status		Setting							
Digital Inputs											
I01	I02	I03	I04	I05	I06	I07	I08	I09	I0A	I0B	I0C
OFF	OFF	OFF	OFF	OFF	OFF	OFF	OFF	OFF	OFF	OFF	OFF
Analog Inputs						Temperature Inputs					
A01	A02	A03	A04	A05	A06	A07	A08	AT01	AT02	AT03	AT04
00.00V	00.00V	00.02V	00.00V	00.00V	00.00V	00.00V	00.00V	000.0C	000.0C	000.0C	000.0C
Digital Outputs						Analog Outputs					
Q01	Q02	Q03	Q04	Q05	Q06	Q07	Q08	AQ01	AQ02	AQ03	AQ04
OFF	OFF	OFF	OFF	OFF	OFF	OFF	OFF	00.00 V	00.00 V	00.00 V	00.00 V

Setting page: page to modify the password of the web server credentials.

Lovato electric

SYSTEM		IO Status		Setting	
Old Password					
New Password					
Confirm Password					
Login		Reset			
https://www.LovatoElectric.com/					

NETWORK COMMUNICATION BETWEEN TWO LRK DEVICES

Multiple LRK can be used for monitoring of input and output points through network and for remote control of the input and output points.

Network input and output:

- Network digital input and output J (01~3F), K (01~3F);
- Network analog input and output NAI(01~1F), NAQ(01~0F); LRK may use network input and output as coil or parameter.

Example:

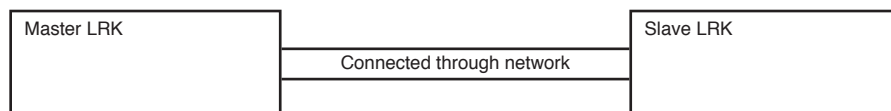

Note.

This configuration can be extended up to a maximum of 8 LRK slaves connected in ethernet with the LRK master.

The total number of the network I/O available resources (independently from the number of LRK slaves) are: 63 network digital inputs, 63 network digital outputs, 31 network analog inputs and 15 network analog outputs.

Master J01~J3F can be configured according to status of the corresponding slave point. Master and slave setting in the case master J02 reads status of slave coil M03:

Master: Q01 is controlled by J02, and status of J02 depends on status of slave M03.



Slave: M03 is controlled by M32, and set ON or OFF within 0.5s.



Phenomenon: Status of master Q1 and J01 and slave M03 is consistent.

Master

1: Configure master IP

Enter the main menu, select "Network configuration", and press "OK" for network configuration. Configure IP address, gateway address and subnet mask based on link status.

```
IP ADDRESS
SUBNET MASK
GATEWAY
MASTER IP
```

Select "IP ADDRESS", and press "OK" to ensure the IP address setting menu.

Press "SEL" to enter the editing mode, set master address as 10.128.19.247, and press "OK" to save the IP address setting.

```
IP ADDRESS
010.128.019.247
```

Select "SUBNET MASK", and press "OK" to enter the subnet mask setting menu.

Press "SEL" to enter the editing mode, set subnet mask as 255.255.255.0, and press "OK" to save the subnet mask setting.

```
SUBNET MASK
255.255.255.000
```

Select "GATEWAY", and press "OK" to enter the gateway address setting menu.

Press "SEL" to enter the editing mode, set master address as 192.168.000.001, and press "OK" to save the gateway address setting.

```
GATEWAY
192.168.000.001
```

2. Set master

Select "NETCONFIG" under the main menu, and press "OK".

```

OUTPUT RECORD
FORMAT Card
> NETCONFIG
NET IO SET
  
```

Select "NET SET" under the "NETCONFIG" menu, and press "OK".

```

GATEWAY
MASTER IP
IAP SET
> NET SET
  
```

Select master.

```

M/S SET           M
  
```

3: Configure network I/O address mapping

The configuration of the network I/O addressing can be done on the software LRXSW (menu Operation -> Network set -> Network I/O; see the example of the page 217) or alternatively from the display of the master LRK as described below.

On the LRK master select "NET IO SET" under the main menu, press OK key then move cursor to "JNI01"; press "SEL" to enter the editing mode, select "JNI02" and press "OK" for configuration of coil J02.

```

Set:      J02
Set:      K01
Set:      NAI01
Set:      NAQ01
  
```

Press "SEL" to enter the editing mode:

Enter the correct IP address (slave IP address, 10.128.19.245 in this example)

Enter the correct slave coil

```

SET:      J01
SLAVE IP
010.128.019.245
SET:      M03
  
```

4: Edit program under main menu

J02_____Q01

Press "ESC" to exit the program editing interface.

Caution: Please complete step 3 before turning to step 4.

Slave:

1: Configure slave IP

Configure IP address, gateway address, subnet mask and master IP according to link status.

```

IP ADDRESS
SUBNET MASK
GATEWAY
MASTER IP
  
```

Set IP address, gateway address and subnet mask as per instructions for master setting.

Set IP address as: 10.128.19.245

Set subnet mask as: 255.255.255.000

Set gateway address as: 192.168.000.001

Select "Set master IP", and press "OK" to enter the master IP setting menu.

Press "SEL" to enter the editing mode, set master address as 10.128.19.246, and press "OK", when the device will restart automatically and save the gateway address setting.

```

Set master IP
010.128.019.246
  
```

2: Set slave

Select "NETCONFIG" under the main menu, and press "OK".

```
OUTPUT RECORD
FORMAT Card
> NETCONFIG
NET IO SET
```

Select "NET SET" under the "NETCONFIG" menu, and press "OK".

```
GATEWAY
MASTER IP
IAP SET
> NET SET
```

Select slave.

```
M/S SET      S
```

Run the program after correct configuration and connection; LAN LED should be flashing in case of successful communication.

MODBUS TCP FUNCTION/MODBUS RTU OVER TCP FUNCTION

MODBUS function block of LRK device enables Modbus TCP and Modbus RTU over TCP communication functions through Ethernet interface. The functions of MODBUS block are detailed in Chapter 8 (Function Specification of LRK20RD024RS Type).

Device ID setting:

Open LRXSW software, and click Module System Set window under the Operation menu:

The 'Module System Set' dialog box contains the following settings:

- Set ID:** Current ID: 1, New ID(00-99): 1 (highlighted in red)
- Remote I/O:** NO, Master, Slave
- Set Expand I/O:** I/O Num: 0, I/O Alarm
- Others:** M Keep, C Keep, Back Light, Z Set
- RS485 Set:** Comm. Mode: 8/N/2, Baud Rate: 38400
- DR Format Set:** Unsigned, Signed
- Coil Record:** None, M, N, Range: 01-10, SUM=0

Enable LRK device of the master station mode and set ID as 0; enable LRK device of the slave station mode and set ID as 0-99 (except 0); slave station device ID is unrepeatable.

Master station device setting:

Enter LCD interface of LRK device (-> Network setting->Network communication->), and set the device in the master station mode.

Open LRXSW software, and click Network Set window under the Operation menu:

The 'Network Set' dialog box shows the following table:

Index	ID	IP
1	1	169.254.200.33
2	2	169.254.200.53
3	3	169.254.200.44
4	0	0.0.0.0
5	0	0.0.0.0
6	0	0.0.0.0

At the bottom, the 'MODBUS TCP/IP' radio button is selected and highlighted in red.

Set ID and IP address of the slave station to be connected (Note: It should be consistent with that of slave station device) in the MODBUS TCP/IP column. The options in the red frame at the bottom are for selection of Modbus TCP or Modbus RTU over TCP when the communication mode is set.

Download to LRK device after setting. The setting becomes effective only after the device is powered-on again.

The above setting can be modified by KEYPAD in the LCD interface:
-> MODBUS SET ->

MODBUS_TCP		
RTU/TCP		TCP
CHANNEL		01

MODBUS_TCP		
RTU/TCP		RTU
CHANNEL		01

Select Modbus TCP or Modbus RTU over TCP for communication mode setting.
Change CHANNEL (01-08), and press OK to enter the channel setting:

CHANNEL 01		
SERVER_IP		
192.168.000.006		
ID: 01		

IP address of the corresponding slave station and device ID can be modified in this interface.
The device is to be powered-on again after modification of setting. Otherwise, the setting will not become effective.

Slave station device setting:

Enter LCD interface of LRK device (-> Network setting->Network communication->), and set the device in the slave station mode.

Open LRXSW software, and select the Network Set window under the Operation menu:

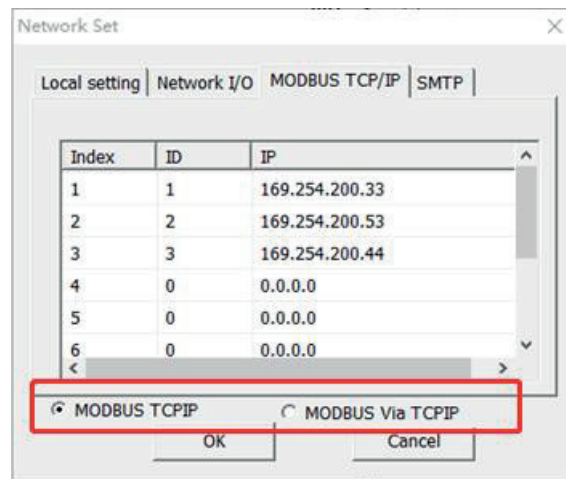

In the MODBUS TCP/IP column, the options in the red frame are for selection of Modbus TCP or Modbus RTU over TCP for communication mode setting (to be consistent with the master station setting). Download to LRK device after setting. The device is to be powered-on again; otherwise, the setting will not become effective.

The above setting can be modified by KEYPAD in the LCD interface:
-> MODBUS SET ->

MODBUS_TCP		
RTU/TCP		TCP
CHANNEL		01

MODBUS_TCP		
RTU/TCP		RTU
CHANNEL		01

Select Modbus TCP or Modbus RTU over TCP for communication mode setting.
The setting becomes effective only after the device is powered-on again upon modification.

Example:

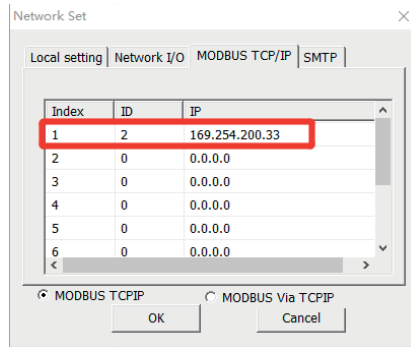

Set ID of the slave station device corresponding to channel 1 as 2 and IP address as 169.254.200.33. User code:

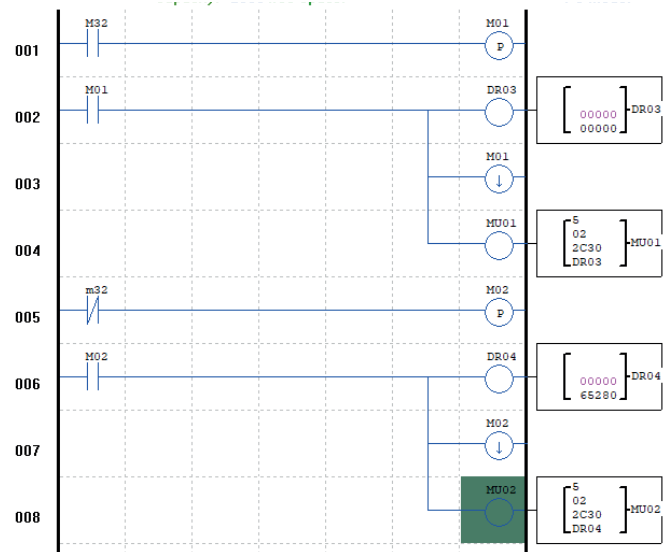

MU module setting:

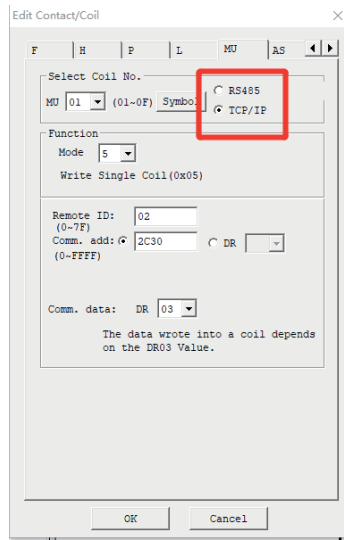

As shown above, TCP/IP is to be selected when Modbus TCP or Modbus RTU over TCP communication is used for the MU module.

E-MAIL TRANSFER FUNCTION

Note. This function is not compatible with SMTP servers that requires the SSL/TLS encrypting.

After LRK device is connected to Ethernet, E-mail can be sent to the E-mail box designated by user through SMTP E-mail transfer protocol. The mail content includes the current status of device input and output points. The corresponding fault code will be sent if the device fails.

E-mail transfer function setting:

Open LRXSW software -> Open Network Set window under the Operation menu, and then set relevant information in the SMTP column:

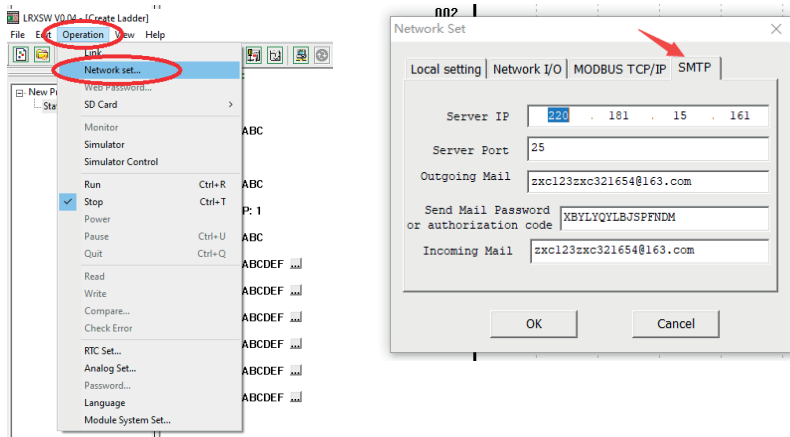

- Notes: Server IP is IP address of SMTP server for the sending mailbox;
- Server Port is the port of SMTP server for the sending mailbox;
- The sending mailbox should have SMTP service enabled and authorization code recorded. The code is the password for third-party client to log in the sending mailbox;
- The receiving mailbox should support SMTP mail receiving to avoid SMTP mail from being treated as junk mail.

Example of sending mailbox setting:

User needs to enter two E-mail boxes, namely the sending mailbox and receiving mailbox, for using the SMTP E-mail transfer function. Third-party client login authorization should be enabled for the sending mailbox, so as to allow LRK login for mail sending.

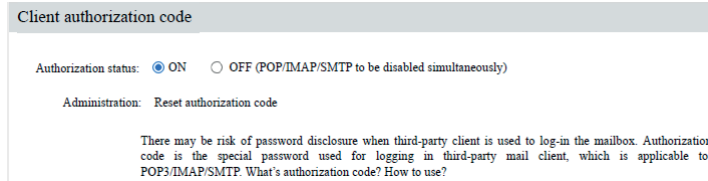

The authorization code (not the password created during mailbox registration) is obtained when authorization is enabled.

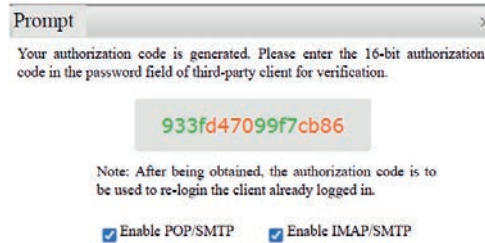

SMTP server of Sina mailbox is shown below:

Client setting: POP3 server: pop.sina.com

SMTP server: smtp.sina.com

SMTP server of Netease mailbox is as follows:

Server address: POP3 server: pop.163.com

SMTP server: smtp.163.com

IMAP server: imap.163.com

As SMTP server address varies with mailbox, user needs to check before using it for acquiring the IP address of SMTP, as instructed below: Press win+R key on the PC, and enter ping (the above-checked SMTP address) in the pop-up window (as shown below) to obtain IP address of SMTP server:

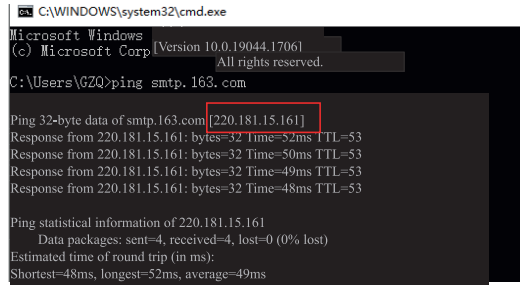

The above selected is the IP address, which is to be entered in server IP. SMTP server port number may be 25, 587. Port number of the sending mailbox server used is to be confirmed.

SMTP related information can be checked in the LCD interface:
-> SMTP DATA ->

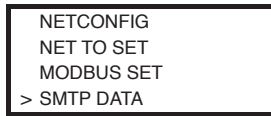

Enter SMTP DATA, and press Up/Down to view SMTP related information.

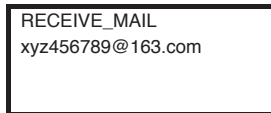
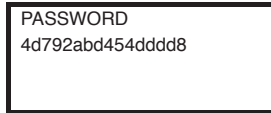
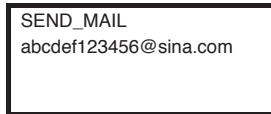
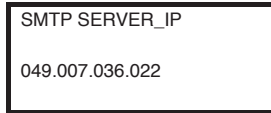

User may check the above-listed information in the LCD interface, but cannot change the same by KEYPAD.

User code example of E-mail transfer function:

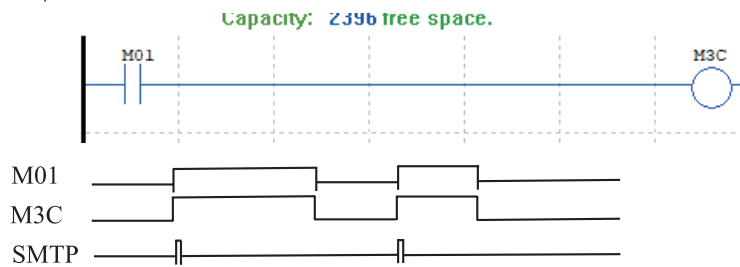

LRK sends an E-mail each time when it is in the rising edge of M3C point.

Chapter 12 Project transfer from LRD to LRK

Chapter 12 Project transfer from LRD to LRK.	229
Conversion of LRD program to use with LRK either already saved as a file or Read (uploaded) directly from LRD	230
Conversion of LRD programs to use with LRK already saved as a file	232

CONVERSION OF LRD PROGRAM TO USE WITH LRK EITHER ALREADY SAVED AS A FILE OR READ (UPLOADED) DIRECTLY FROM LRD
For both cases Station Export/ Import functions must be used .
Example below shows the reading of the program from LRD and transferring to LRK.

Step 1. Using the LRXSW programming software create a new file type LRD and select the type LRD and then the product code from the list (example: LRD12RD024).

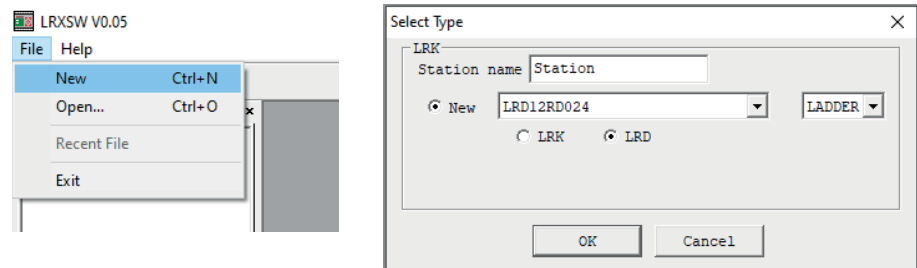

Step 2. Connect the LRD to the PC with software LRXSW. Click on the menu Operation -> Link and select the COM port according to the one used on your laptop.

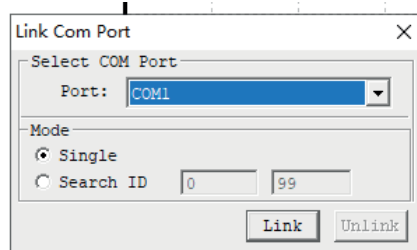

Step 3. Read the project from the LRD. Then click on the menu Station -> Export.

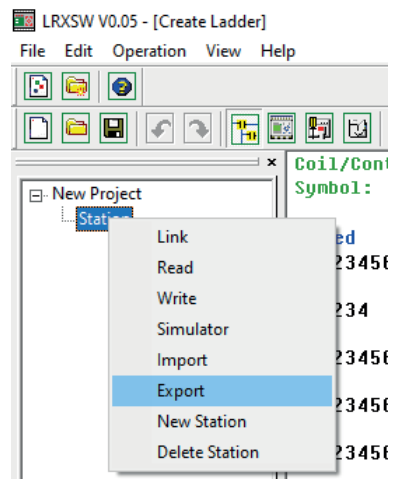

Save the file with name on your PC. Note. The file extension of the LRD project is .gen.

Step 4. Create a new file for LRK Clic on Station and New and select LRK then the LRK model.

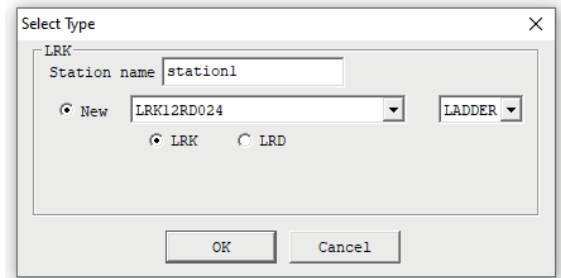
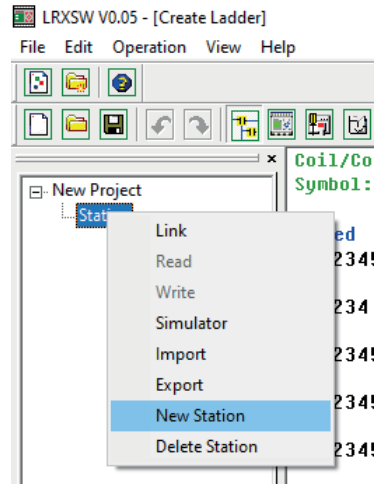

Step 5. Select Station -> Import and open the LRD program file previously saved. Once imported and displayed on the screen go to the next step.

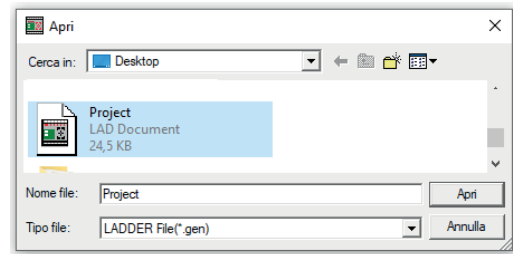
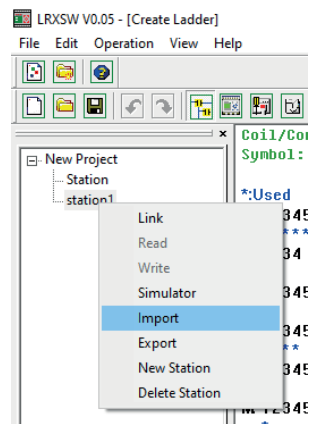

Step 6. Connect to the LRK unit and use the Write function to download the program to the LRK via ethernet connection. For this you can refer to the LRK instruction manual if necessary.

CONVERSION OF LRD PROGRAMS TO USE WITH LRK ALREADY SAVED AS A FILE

Example below shows the Reading of a program that has been previously compiled using the previous release of LRXSW programming software.

Step 1. Use the LRXSW programming software (latest version 0.05 or greater) and create a new station for the LRK unit that has to be programmed with the program that was developed for LRD.

Select the type LRK and then the LRK product code from the list, then press OK.

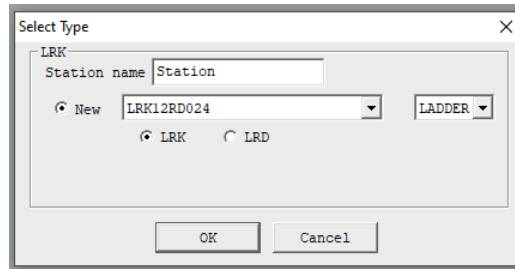

Step 2. Right click on the menu Station and select the Import function.

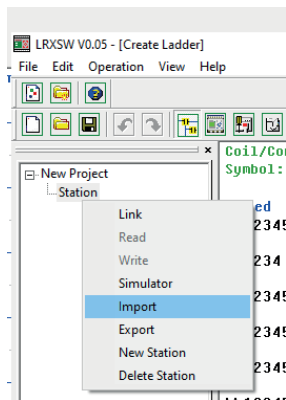

Step 3. Select the project file that had previously saved on the PC for LRD. Then select open.

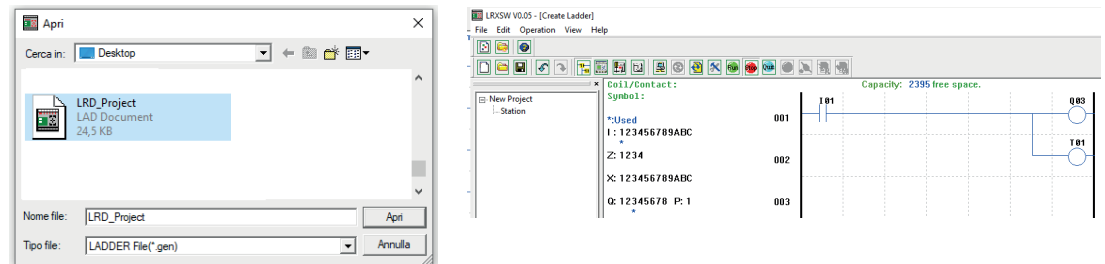

Step 4. Connect to the LRK unit and use the Write function to download the program to the LRK via ethernet connection. For this you can refer to the LRK instruction manual if necessary.