









-  SCARICATORI DI SOVRATENSIONE
 SURGE PROTECTION DEVICES
 ÜBERSpannungsABLEITER
 DISPOSITIVOS DE PROTECCIÓN CONTRA SOBRETENSIONES

SG2 DG 600M2R



Product name	SG2 DG 600M2
	SG2 DG 600M2R
U _{cpv}	600V
I _n (8/20)	20kA
I _{total} (8/20)	50kA
I _{max} (8/20)	40kA
U _p	1900V
U _p @ 15kA	1750V
U _{res} @ 10kA	1650V
U _{res} @ 5kA	1500V
I _{scpv}	11kA
I _{PE} (AC/DC)	0.3 mA / <30 μA
SPD overload behaviour mode	Open Circuit Mode (OCM)
Type of PV systems	Not earthed/earthed

Operating temperature Ta	-40 °C to +85 °C
RH	5%...95%
Mounting	35mm DIN rail, EN 60715
Number of ports	1
Location	Indoor
Altitude (max)	4000m
Degree of protection	IP20 (built-in)
 (solid, stranded) 18mm	ø min 1.5mm ² / ø max 35mm ² / ø min 16 AWG / ø max 2 AWG
 (flexible) 18mm	ø min 1.5mm ² / ø max 25mm ² / ø min 16 AWG / ø max 4 AWG
 PH	PH2 / SLOT ¼
 RC push in (stranded)  12mm	ø min 0.25mm ² / ø max 1.5mm ² / ø min 24 AWG / ø max 16 AWG

WARNING!

- This equipment is to be installed by qualified personnel, complying to current standards, to avoid damages or safety hazards. 
- The manufacturer cannot be held responsible for electrical safety in case of improper use of the equipment.
- Products illustrated herein are subject to alteration and changes without prior notice. Technical data and descriptions in the documentation are accurate, to the best of our knowledge, but no liabilities for errors, omissions or contingencies arising there from are accepted.

ATTENTION !

- Ces appareils doivent être installés par un personnel qualifié, conformément aux normes en vigueur en matière d'installations, afin d'éviter de causer des dommages à des personnes ou choses. 
- Le constructeur n'assume aucune responsabilité quant à la sécurité électrique en cas d'utilisation impropre du dispositif.
- Les produits décrits dans ce document sont susceptibles d'évoluer ou de subir des modifications à n'importe quel moment. Les descriptions et caractéristiques techniques du catalogue ne peuvent donc avoir aucune valeur contractuelle.

ACHTUNG!

- Zur Vermeidung von Personen- und Sachschäden dürfen diese Geräte nur von qualifiziertem Fachpersonal und unter Befolgung der einschlägigen Vorschriften installiert werden. 
- Bei zweckwidrigem Gebrauch der Vorrichtung übernimmt der Hersteller keine Haftung für die elektrische Sicherheit.
- Die in dieser Broschüre beschriebenen Produkte können jederzeit weiterentwickelt und geändert werden. Die im Katalog enthaltenen Beschreibungen und Daten sind daher unverbindlich und ohne Gewähr.

ADVERTENCIA

- Este dispositivo debe ser instalado por personal cualificado conforme a la normativa de instalación vigente a fin de evitar daños personales o materiales. 
- El constructor no se responsabilizará de la seguridad eléctrica en caso de que el dispositivo no se utilice de forma adecuada.
- Los productos descritos en este documento se pueden actualizar o modificar en cualquier momento. Por consiguiente, las descripciones y los datos técnicos aquí contenidos no tienen valor contractual.

UPOZORNĚNÍ

- Tato zařízení smí instalovat kvalifikovaní pracovníci v souladu s platnými předpisy a normami pro předcházení úrazů osob či poškození věcí. 
- Vyrobcem nenese odpovědnost za elektrickou bezpečnost v případě nevhodného používání regulátoru.
- Vyroby popsané v tomto dokumentu mohou kdykoliv projít úpravami či dalším vývojem. Popisy a údaje uvedené v katalogu nemají proto žádnou smluvní hodnotu.

AVVERTIZARE!

- Acest echipament va fi instalat de personal calificat, în conformitate cu standardele actuale, pentru a evita deteriorări sau pericolele. 
- Producătorul nu poate fi considerat responsabil pentru siguranța electrică în caz de utilizare incorectă a echipamentului.
- Produsele ilustrate în prezentul sunt supuse modificărilor și schimbărilor fără notificare anterioară. Datele tehnice și descrierile din documentație sunt precise, în măsura cunoștințelor noastre, dar nu se acceptă nicio răspundere pentru erorile, omisiunile sau evenimentele neprevăzute care apar ca urmare a acestora.



ATTENZIONE!

- Questi apparecchi devono essere installati da personale qualificato, nel rispetto delle vigenti normative impiantistiche, allo scopo di evitare danni a persone o cose. 
- Il costruttore non si assume responsabilità in merito alla sicurezza elettrica in caso di utilizzo improprio del dispositivo.
- I prodotti descritti in questo documento sono suscettibili in qualsiasi momento di evoluzioni o di modifiche. Le descrizioni ed i dati a catalogo non possono pertanto avere alcun valore contrattuale.

UWAGA!

- W celu uniknięcia obrażeń osób lub uszkodzenia mienia tego typu urządzenia muszą być instalowane przez wykwalifikowany personel, zgodnie z obowiązującymi przepisami. 
- Producent nie przyjmuje na siebie odpowiedzialności za bezpieczeństwo elektryczne w przypadku niewłaściwego użytkowania urządzenia.
- Produkty opisane w niniejszym dokumencie mogą być w każdej chwili udoskonalone lub zmodyfikowane. Opis oraz dane katalogowe nie mogą mieć w związku z tym żadnej wartości umownej.

警告!

- 本设备只能由合格人员根据现行标准进行安装，以避免造成损坏或安全危害。 
- 制造商不负责因设备使用不当导致的电气安全问题。
- 此处说明的产品可能会有变更，恕不提前通知。我们竭力确保本文中技术数据和说明的准确性，但对于错误、遗漏或由此产生的意外事件概不负责。

ПРЕДУПРЕЖДЕНИЕ!

- Во избежание травм или материального ущерба монтаж должен осуществляться только квалифицированным персоналом в соответствии с действующими нормативами. 
- Производитель не несет ответственность за обеспечение электробезопасности в случае ненадлежащего использования устройства.
- Изделия, описанные в настоящем документе, в любой момент могут подвергнуться изменениям или усовершенствованиям. Поэтому каталожные данные и описания не могут рассматриваться как действительные с точки зрения контрактов.

DIKKATI

- Bu aparatlar kişilere veya nesnelere zarar verme ihtimaline karşı yürürlükte olan sistem kurma normlarına göre kalifiye personel tarafından monte edilmelidir. 
- Üretici aparatın hatalı kullanımından kaynaklanan elektriksel güvenliği ait sorumluluk kabul etmez.
- Bu dokümanda tarif edilen ürünler her an evrimlere veya değişimlere açıktır. Bu sebeple katalogdaki tarif ve değerler herhangi bir bağlayıcı değeri haiz değildir.

NOTA: Le informazioni riportate nel presente documento potrebbero essere soggette a modifiche senza preavviso.

NOTE: Contents of this publication can be modified without prior notice.

NOTA: El contenido de este documento podrá modificarse en el futuro sin notificación previa.

Protection Configurations

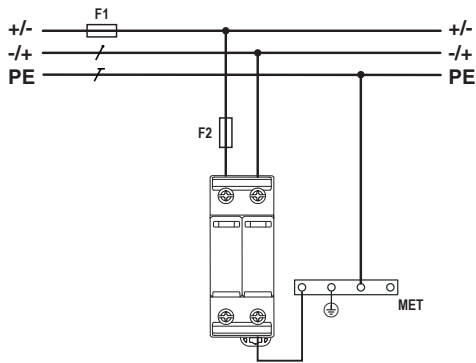

7 PE Conductor

Fault indication

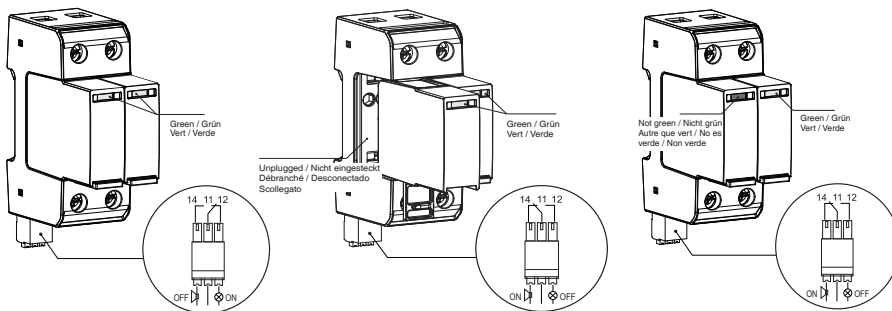

Remote signalization

A.C.		D.C.		
250V / 1A	125V / 1A	48V / 0.5A	24V / 0.5A	12V / 0.5A

RC contact(s) states	11- 12	11-14
SPD module(s) functional / installation is protected	Closed	Open
SPD module(s) unplugged or non-functional / installation is unprotected	Open	Closed

Dimensions

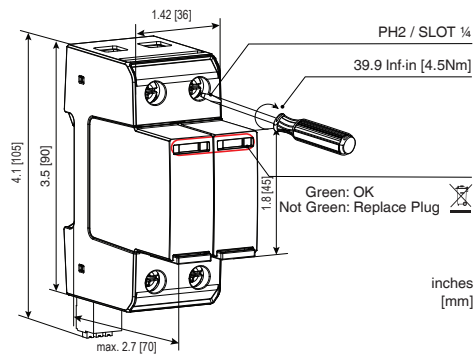

Plug replacement

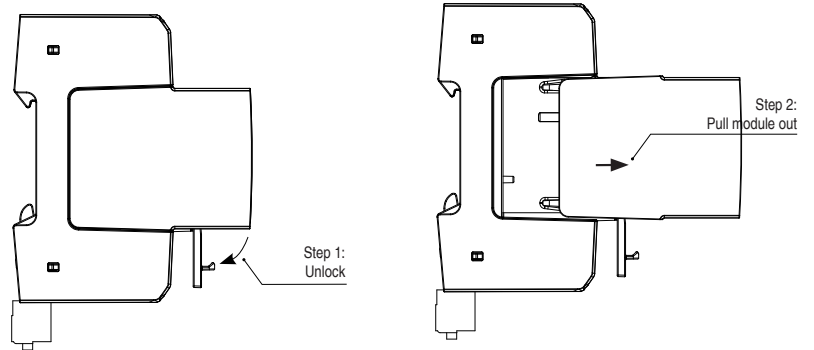

• Earthing conductors of Type 2 SPDs shall have a minimum cross-sectional area of 6 mm² copper or equivalent or equal to the cross section area of live conductors, if greater than 6 mm².

• In case of existing national regulations about maintenance and control of LPS (Lightning Protection System) which are more demanding, the usage of those regulations is necessary, otherwise it is advised to do maintenance and control according to standard IEC 62305-3:2010, chapter - E.7.

• Based on the mentioned standard, annual complete control is recommended (visual control and measurements) or after every lightning strike in that area.