



- Gateway
- Data storage on local memory
- Data transfer via internet
- Ethernet cable, Wi-Fi or mobile connection to the internet
- Geolocation.

Communication devices

	SEC. - PAGE
Gateway data loggers	34 - 4
Gateway	34 - 5
Converter	34 - 5
Antennas	34 - 5
Remote control and monitoring GSM modem via SMS	34 - 6
Dimensions	34 - 7



Page 34-4

GATEWAYS

- Data loggers
- RS485 serial communication port
- 1 or 2 Ethernet ports
- Connection to Wi-Fi access point
- 4G (LTE) mobile connections
- GNSS (GPS) support.



Page 34-5

CONVERTER

- RS485-Ethernet converter
- Modbus RTU-TCP protocol conversion.



Page 34-5

ANTENNAS

- Antenna for 4G networks
- Antenna for GNSS receivers
- Antenna for Wi-Fi networks
- SMA male connectors.

EXCGLB... GATEWAY DATA LOGGERS

The EXCGLB... is a combined gateway and data logger and is key to the construction of modern, functional and efficient monitoring systems. The device logs data from LOVATO Electric devices or ambient sensors running compatible protocols and monitors all kinds of energy vector (water, air, gas, electricity or steam). Logged data can be consulted via the built-in web server and transmitted either to LOVATO Electric's **Synergy** supervision software or to remote servers in suitable formats for further processing.



● WEB SERVER INTEGRATION

The EXCGLB... is equipped with a built-in web server that lets you:

- consult and download collected data
- view time-referenced charts and tables for historic analyses
- define what categories of collected data must be sent automatically to the **Synergy** supervision software or other destinations.

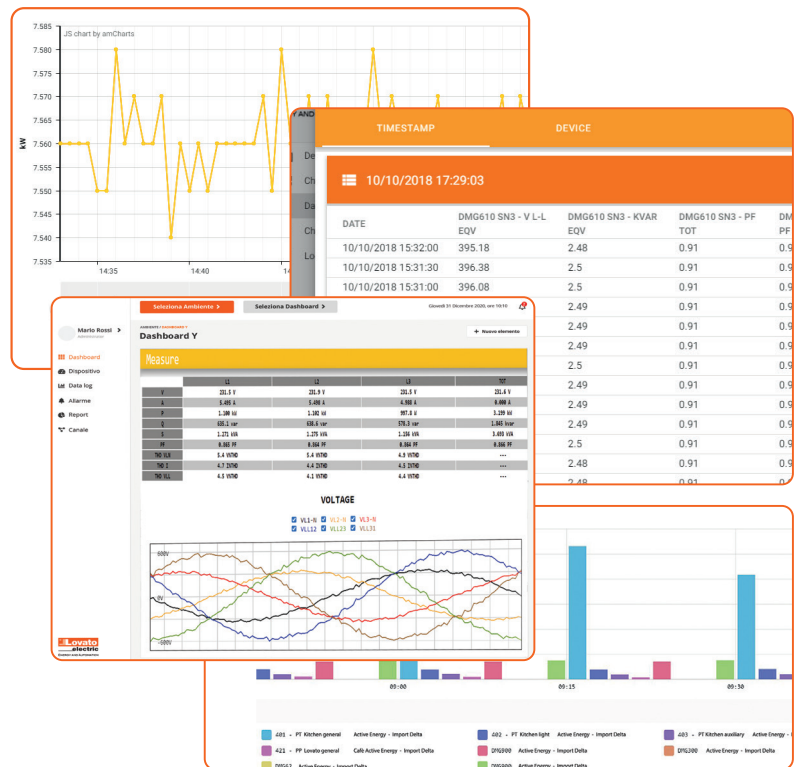

● INTEGRATION WITH **Synergy**

The **Synergy** energy supervision system is the result of LOVATO Electric's extensive experience in four different but synergic areas: hardware devices, monitoring software, technical assistance and training. Connecting the EXCGLB... to LOVATO Electric's **Synergy** monitoring services delivers the following advantages:

- automatic access to data loggers, synoptic pages and graphics in a standard configuration that does not require any user intervention
- transmitted data can be processed freely and displayed graphically on web pages that can be customised to meet specific customer needs
- guaranteed data security even in the event of internet instability.

● THIRD PARTY COMPATIBILITY

- Regular transfer of data to third party software in encrypted mode in XML via http/https or CSV files via sftp/ftp
- mqtt live data transfer
- Third party Modbus devices support.

● FUNCTIONAL CHARACTERISTICS

- Connection to field devices via RS485 and/or Ethernet
- Internet connection via cabled network, Wi-Fi or 4G modem
- Geolocation via GNSS (GPS)
- Communication with remote servers via http, https, ftp and sftp protocols: neither static public IP addresses nor specific TCP ports are needed

- Regular transfer of data to **Synergy** supervision software in encrypted mode in XML files via http/https or CSV files via sftp/ftp
- mqtt live data transfer to **Synergy**
- Data and report export via web servers in Excel or CSV format
- Plug and play: auto-recognition of compatible devices connected via the Ethernet or serial channel
- Automatic data bank creation based on a set of typical measurements.

● NETWORK TYPE

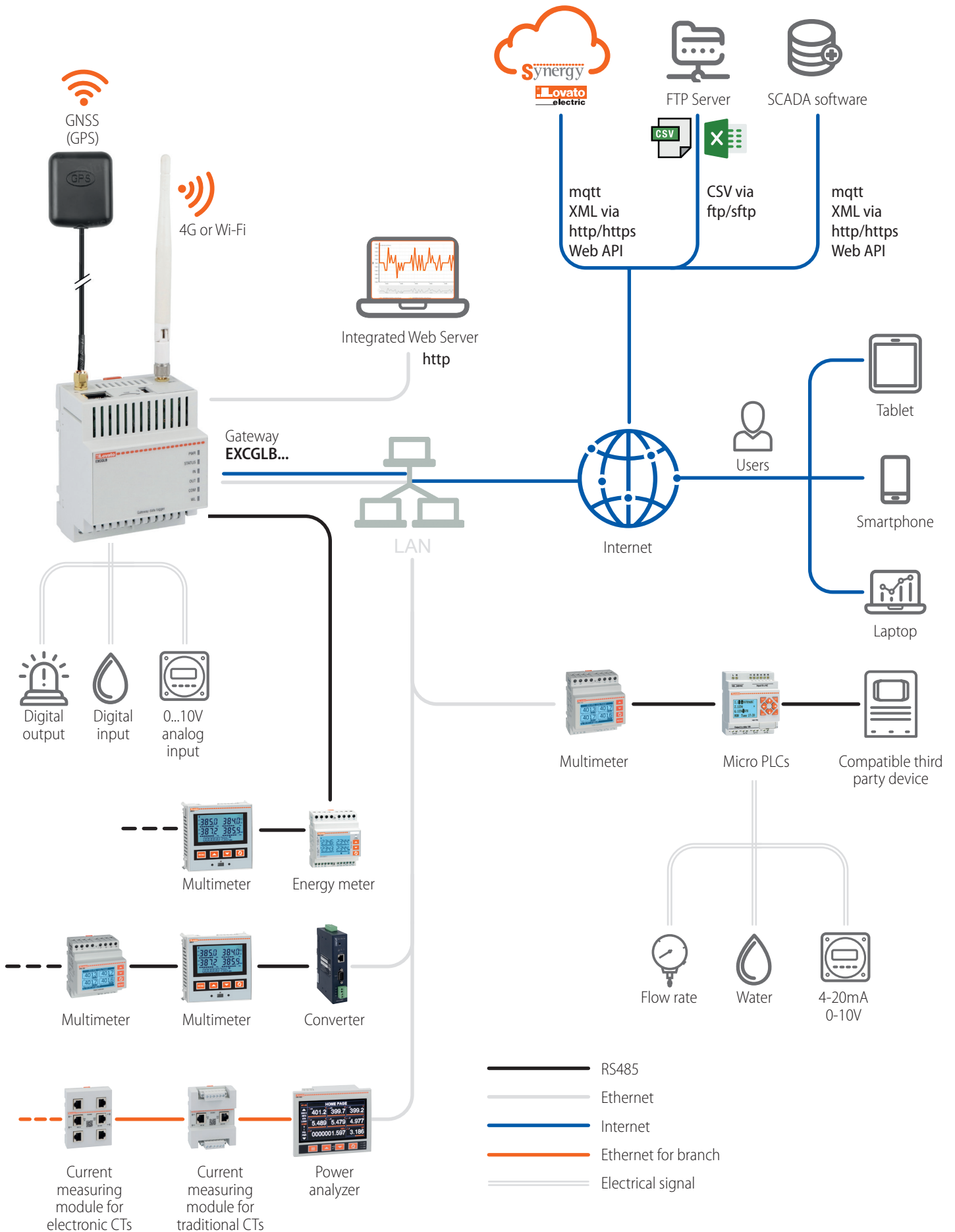

Gateway data loggers



new

EXCGLB...

Order code	Description	Qty per pkg	Wt [kg]
EXCGLB01	Gateway data logger, 1 RS485 port, 1 Ethernet port, Wi-Fi connection	1	0.190
EXCGLB02	Gateway data logger, 1 RS485 port, 1 Ethernet port, LTE connection, GNSS (GPS)	1	0.190
EXCGLB03	Gateway data logger, 1 RS485 port, 2 Ethernet ports, 4G (LTE) connection	1	0.190

General characteristics EXCGLB...

The EXCGLB... gateway data loggers have been designed to concentrate field data and make them available for consultation via a local web interface or remote software. They are suitable for use in monitoring simple systems such as pumps driven by soft starters, machines equipped with motors with variable speed drives or microPLCs, power factor correction systems, or for the supervision of complex systems such as shopping centers or industries. With the version equipped with GPS it is also possible to geolocate machines, such as rental generators. Communication with the devices in the field takes place via RS485 serial port or Ethernet, while the connection to the data collection software can be via the integrated Ethernet ports or via the 4G (LTE) mobile network.

Operational characteristics

- Power supply: 12...24VDC
- RS485 serial port: TR - A - B - GND
- Ethernet port (1 or 2, independent)
- 1 digital input
- 1 analog input 0...10
- 1 static NO output
- 4G antenna connector
- GPS antenna connector
- LED: power, device status, data, input status, output status, wireless communication
- Native integration with **Synergy** and **Synergy cloud**
- Third party software support
- Third-party device support
- Data storage in flash memory
- Operating temperature: -20...+60°C
- Modular DIN 43880 housing (4 modules)
- IEC degree of protection: IP20.

Compliance

Compliance with standards: EN/BS 60950-1.

Available versions

Communication	EXCGLB01	EXCGLB02	EXCGLB03
RS485 port	● (Modbus RTU master)	● (Modbus RTU master)	● (Modbus RTU master)
Ethernet port	1	1	2 (independent networks)
Wi-Fi connection	●	-	-
4G mobile connection (built-in)	-	● (MicroSim)	● (MicroSim)
GNSS (GPS) function	-	●	-
Digital/Analog input, digital output	1 digital input 1 analog input 0...10V 1 digital output @24VDC	1 digital input 1 analog input 0...10V 1 digital output @24VDC	1 digital input 1 analog input 0...10V 1 digital output @24VDC
Network protocols and services	MQTT http/https VPN client Modbus TCP master (device side) FTP	MQTT http/https VPN client Modbus TCP master (device side) FTP	MQTT http/https VPN client Modbus TCP master (device side) FTP

Typical applications

	EXCGLB01	EXCGLB02	EXCGLB03
Metering instruments (power analyzer, energy meter...)	●	-	●
Power factor controllers	●	-	-
Power factor controllers (with advanced analysis requirements)	-	-	●
Soft starters	●	●	-
Variable speed drives	●	●	-
Micro PLCs	●	●	-
Automatic transfer switch controllers	●	-	-
Engine and generator controllers	-	●	-

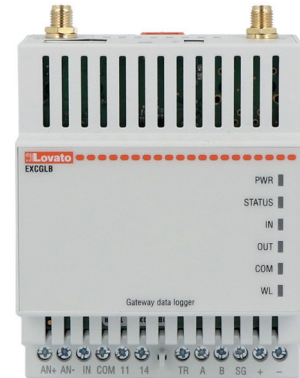

0...10V analog input

Digital input

Digital output

RS485 port with thermal resistor option

EXCGLB01

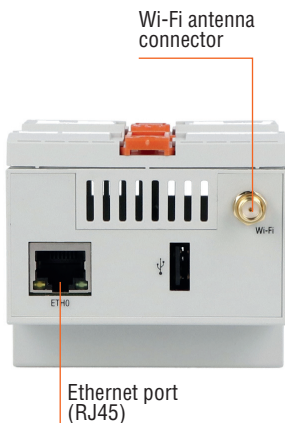

EXCGLB02

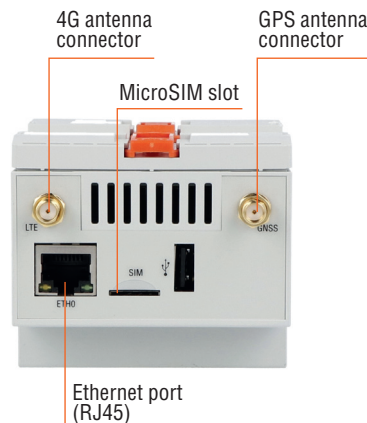

EXCGLB03

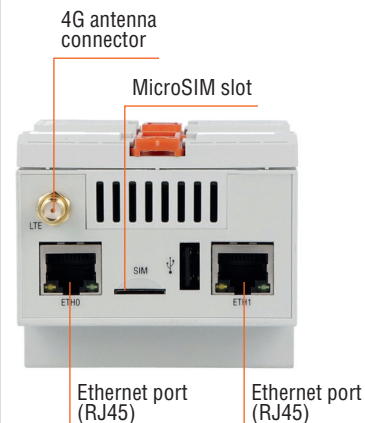

Gateway



EXCM4G01

Order code	Description	Qty per pkg	Wt
		n°	[kg]
EXCM4G01	4G Gateway with RS485 and Ethernet port, Modbus RTU/TCP protocol	1	0.300

EXCM4G01 general characteristics

- The EXCM4G01 gateway can interface "Slave" devices connected in a RS485 with a "Master" using a 4G network:
- Connection to TCP server through 4G or 2G network
 - Operating mode either as transparent or Modbus-RTU/TCP protocol conversion from serial side to mobile network
 - Settable parameters: TCP server IP and remote port, network operator apn (with username and password), SIM card pin (with enabling), connection time-out, serial parameters (baud rate from 1,200 bps to 115,200 bps, stop bit, character length, parity)
 - Programming via built-in web server
 - 1 Ethernet port 10/100Mbps
 - 1 RS485 port
 - Supply 9...36VDC
 - Operating temperature -40...75°C.

Compliance

Compliance with standards: EN/BS 60950-1.

Converter



EXCCON02

new

Order code	Description	Qty per pkg	Wt
		n°	[kg]
EXCCON02	RS485/Ethernet converter, 9...48VDC, with Modbus RTU/TCP protocol conversion functionality	1	0.400

General characteristics EXCCON02

- EXCCON02 converter lets the "Slaves" devices connected to an RS485 network be interfaced with a "Master" equipped of Ethernet ports:
- Modbus RTU/TCP protocol conversion
 - Programming via web interface
 - Power supply excluded.

Compliance

Compliant with standards: IEC/EN/BS 55032, IEC/EN/BS 55024, IEC/EN/BS 55035.

Antennas



CX05



CX06



CX07

new

Order code	Description	Qty per pkg	Wt
		n°	[kg]
CX05	4G (LTE) antenna 698-960MHz/1710-2700MHz	1	0.030
CX06	GNSS (GPS, BeiDou/COMPASS) antenna 1575.42MHz/1561.098 MHz	1	0.150
CX07	Wi-Fi antenna 2.4-2.5GHz/4.9-5.825GHz	1	0.010

Compatibility of antennas with LOVATO Electric products

TIPO	GATEWAY DATA LOGGERS			GATEWAY
	EXCGLB01	EXCGLB02	EXCGLB03	EXCM4G01
CX05		●	●	●
CX06		●		
CX07	●			

General characteristics

- CX05**
Omnidirectional antenna for use with 4G (LTE) networks in the 698-960MHz/1710-2700MHz frequency bands. SMA male plug directly connected to the antenna connector.
- CX06**
Active antenna for GNSS receivers (GPS, BeiDou/COMPASS) in the 1575.42MHz ± 3MHz and 1561.098 MHz ± 5MHz bands.
SMA male plug connected to the receiver via a 3m cable.
IP65 protection rating.
Fixing via magnetic base.
- CX07**
Omnidirectional antenna for use with 2.4GHz and 5GHz Wi-Fi networks in the 2.4-2.5GHz/4.9-5.825GHz frequency bands.
SMA male plug directly connected to the antenna connector.

Remote control and monitoring GSM modem via SMS

Compliant with Italian CEI 0-16 Standard, paragraph 8.8.6.5 and annex M, resolution 421/2014 of the ARERA



Order code	Description	Qty per pkg	Wt
	GSM Modem (modular - 4U). IP69K outside aerial with 2.5 m cable. RJ45-USB programming cable (included).	n°	[kg]
EXCGSM01	100...240VAC, 1 digital input, 1 analog input (0...10V, 0...20mA, NTC), 1 relay output, receiving and sending SMS messages for remote controls and alarm signals	1	0.340

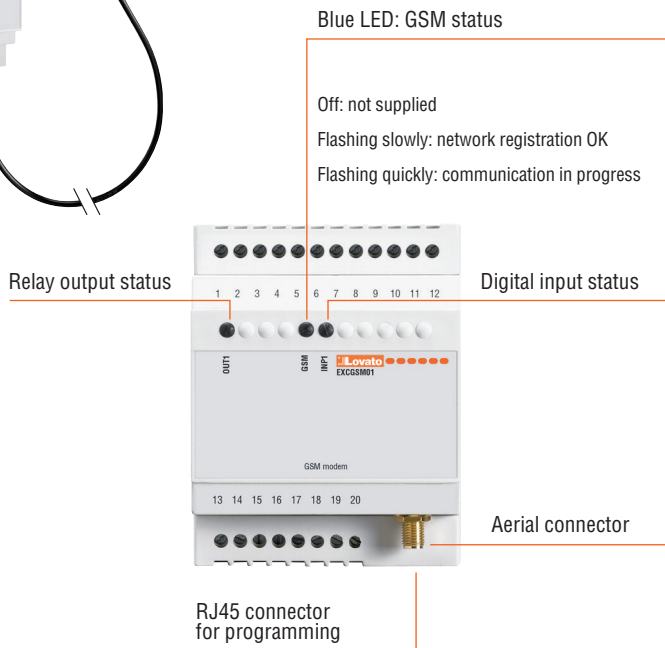

Application requirements

With EXCGSM01 it is possible to remotely operate a relay output and obtain information on the system by sending programmable SMS. Using the configuration software (available for download free of charge from www.lovatoelectric.com) the user can control the relay output and both the digital and analog inputs.

The logic is based on events (for example, the activation of the digital input or the arrival of an SMS with specific text), to which the user can decide specific actions (reply either by SMS or voice message, or by switching the relay output). The analog input can be connected to detectors of physical measures like pressure, fluid tank level or temperature to allow remote reading of values or sending text messages via SMS or alarms. The EXCGSM01 modem interfaces with the cellular network to regularly update its internal clock and dawn/dusk settings, so that it can manage time-scheduled events properly. Information can be retrieved from phone network cells relative to the position of the modem (reading position information and sending alarms via SMS).

Applications:

- Detection of boiler temperature thresholds
- Fluid tank level alarms
- Time and date based load management
- Remote lighting and air conditioning system control
- Detection of moving of rental equipment.

Use with CEI 0-16

The CEI 0-16 standard in paragraph 8.8.6.5 and in attachment M prescribes that the electricity production plants powered by wind or solar photovoltaic sources with power greater than or equal to 100kW, connected or to be connected to medium voltage grids, are equipped with GSM modem.

Thanks to this modem it is possible to manage the disconnection of the generation through the messages sent by the energy distributor.

Functional characteristics

- Connection to the GSM network for sending and receiving SMS messages
- Programmable message texts
- Command output piloted by SMS or internal logic, for example to send the remote disconnection command to the interface switch CEI 0-16
- Programmable digital input, for example to detect the status of the Interface switch (IS) and sending of successful IS opening and closing SMS
- POD management (active user code)
- Management of the list of caller IDs (CLI) up to 5000 callers enabled
- Detection of mobile network coverage
- Full compatibility with medium-voltage IP LOVATO Electric PMVF30: no software/hardware updates or programming required
- **Compatibility with third-party IPs where the remote disconnection signal is transmitted via digital input (dry contact)** For additional information contact our Technical support
Tel. + 39 035 4282422; E-mail: service@LovatoElectric.com.

Operational characteristics

MODEM

- 35mm DIN (IEC/EN/BS 60715) rail fixing
- 4 modules
- Supply: 100...240VAC
- Consumption: 5VAC
- 1 digital output 3A 250VAC
- 1 self-supplied digital input
- 1 analog input 0...10V, 0...20mA, NTC
- Housing for 3V and 1.8V SIM card
- SIM PIN management
- Temperature sensor
- Update time, sunrise and sunset via GSM network
- Position update via GSM
- Certified according to FCC rules, part 15B
- Operating temperature: -20...+60°C
- Protection rating: IP40 on front; IP20 on terminals.

AERIAL

- Quad band 850/900/1800/1900MHz
- Degree of protection: outside IP69K
- 2.5m cable
- Fixing via M10 hole:
 - with adhesive seal
 - with threaded pin and nut.

Compliance

Compliant with standards: EN/BS 62368, EN/BS 62311.

Software

To configure the EXCGSM01 modem (using the RJ45-USB programming cable included), the EXCGSM01 software must be used. This can be downloaded for free from the www.LovatoElectric.com website. The software allows you to set:

- The users enabled to exchange messages with the modem
 - The identifier of the modem, for example the active customer code (POD) in CEI 0-16 applications
 - The functions assigned to the digital output and input and to analog input
 - The texts of the SMS associated with the commands
 - The logic of the actions taken following the SMS arrival, change of input status, alarm situations.
- Configuration is also possible off-line, creating a file to transfer to the modem at another time.

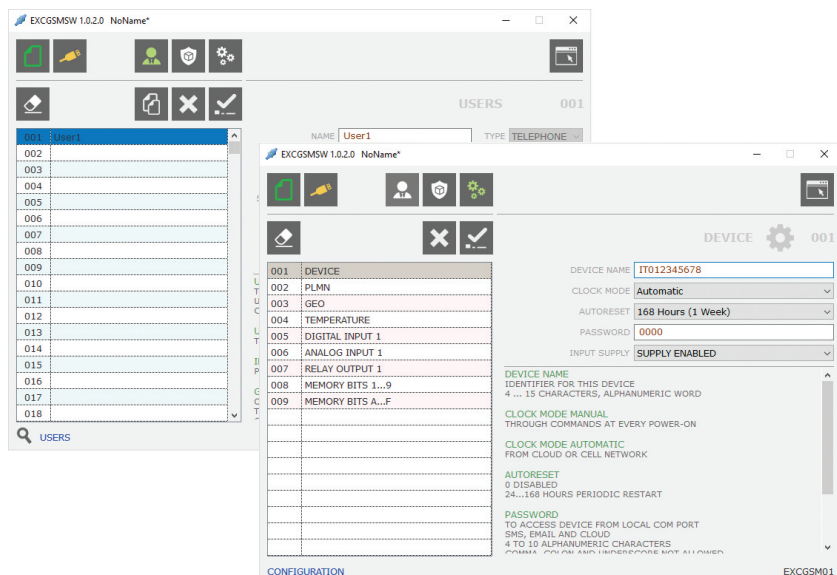

GATEWAY DATA LOGGERS

EXCGLB...

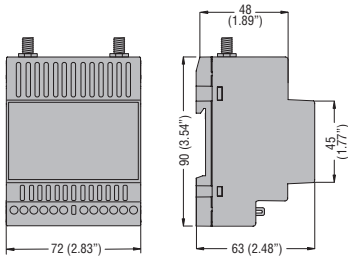

GATEWAY

EXCM4G01

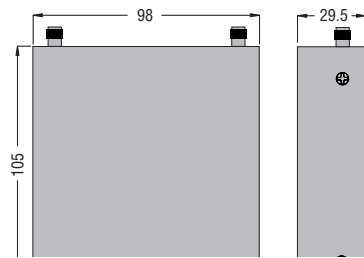

CONVERTER

EXCCON02

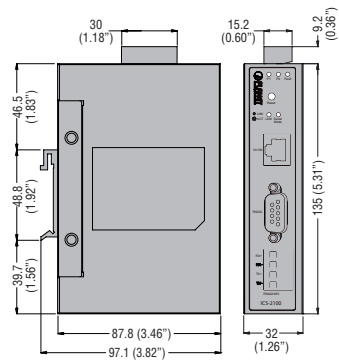

REMOTE CONTROL AND MONITORING GSM MODEM VIA SMS

EXCGSM01

