

LOVATO ELECTRIC S.P.A.

24020 GORLE (BERGAMO) ITALIA  
VIA DON E. MAZZA, 12  
TEL. 035 4282111  
E-mail info@LovatoElectric.com  
Web www.LovatoElectric.com



## VARIABLE SPEED DRIVES

### COMMUNICATION PROTOCOLS (MODBUS RTU, CANOPEN, PROFIBUS, PROFINET, ETHERCAT, MODBUS TCP)

VLB...



#### WARNING!

- Carefully read the manual before the installation or use.
- This equipment is to be installed by qualified personnel, complying to current standards, to avoid damages or safety hazards.
- Before any maintenance operation on the device, remove all the voltages from measuring and supply inputs and short-circuit the CT input terminals.
- The manufacturer cannot be held responsible for electrical safety in case of improper use of the equipment.
- Products illustrated herein are subject to alteration and changes without prior notice. Technical data and descriptions in the documentation are accurate, to the best of our knowledge, but no liabilities for errors, omissions or contingencies arising from are accepted.
- A circuit breaker must be included in the electrical installation of the building. It must be installed close by the equipment and within easy reach of the operator. It must be marked as the disconnecting device of the equipment: IEC/EN/BS 61010-1 § 6.11.3.1.
- Clean the device with a soft dry cloth; do not use abrasives, liquid detergents or solvents.



#### ATTENTION !

- Lire attentivement le manuel avant toute utilisation et installation.
- Ces appareils doivent être installés par un personnel qualifié, conformément aux normes en vigueur en matière d'installations, afin d'éviter de causer des dommages à des personnes ou choses.
- Avant toute intervention sur l'instrument, mettre les entrées de mesure et d'alimentation hors tension et court-circuiter les transformateurs de courant.
- Le constructeur n'assume aucune responsabilité quant à la sécurité électrique en cas d'utilisation impropre du dispositif.
- Les produits décrits dans ce document sont susceptibles d'évoluer ou de subir des modifications à n'importe quel moment. Les descriptions et caractéristiques techniques du catalogue ne peuvent donc avoir aucune valeur contractuelle.
- Un interrupteur ou disjoncteur doit être inclus dans l'installation électrique du bâtiment. Celui-ci doit se trouver tout près de l'appareil et l'opérateur doit pouvoir y accéder facilement. Il doit être marqué comme le dispositif d'interruption de l'appareil : IEC/EN/BS 61010-1 § 6.11.3.1.
- Nettoyer l'appareil avec un chiffon doux, ne pas utiliser de produits abrasifs, détergents liquides ou solvants.



#### ACHTUNG!

- Dieses Handbuch vor Gebrauch und Installation aufmerksam lesen.
- Zur Vermeidung von Personen- und Sachschäden dürfen diese Geräte nur von qualifiziertem Fachpersonal und unter Befolgung der einschlägigen Vorschriften installiert werden.
- Vor jedem Eingriff am Instrument die Spannungszufuhr zu den Messeingängen trennen und die Stromwandler kurzschließen.
- Bei zweckwidrigem Gebrauch der Vorrichtung übernimmt der Hersteller keine Haftung für die elektrische Sicherheit.
- Die in dieser Broschüre beschriebenen Produkte können jederzeit weiterentwickelt und geändert werden. Die im Katalog enthaltenen Beschreibungen und Daten sind daher unverbindlich und ohne Gewähr.
- In die elektrische Anlage des Gebäudes ist ein Ausschalter oder Trennschalter einzubauen. Dieser muss sich in unmittelbarer Nähe des Geräts befinden und vom Bediener leicht zugänglich sein. Er muss als Trennvorrichtung für das Gerät gekennzeichnet sein: IEC/EN/BS 61010-1 § 6.11.3.1.
- Das Gerät mit einem weichen Tuch reinigen, keine Scheuermittel, Flüssigreiniger oder Lösungsmittel verwenden.



#### ADVERTENCIA

- Leer atentamente el manual antes de instalar y utilizar el regulador.
- Este dispositivo debe ser instalado por personal cualificado conforme a la normativa de instalación vigente a fin de evitar daños personales o materiales.
- Antes de realizar cualquier operación en el dispositivo, desconectar la tensión de las entradas de alimentación y medida, y cortocircuitar los transformadores de corriente.
- El fabricante no se responsabilizará de la seguridad eléctrica en caso de que el dispositivo no se utilice de forma adecuada.
- Los productos descritos en este documento se pueden actualizar o modificar en cualquier momento. Por consiguiente, las descripciones y los datos técnicos aquí contenidos no tienen valor contractual.
- La instalación eléctrica del edificio debe disponer de un interruptor o disyuntor. Este debe encontrarse cerca del dispositivo, en un lugar al que el usuario pueda acceder con facilidad. Además, debe llevar el mismo marcado que el interruptor del dispositivo (IEC/EN/BS 61010-1 § 6.11.3.1).
- Limpiar el dispositivo con un trapo suave; no utilizar productos abrasivos, detergentes líquidos ni disolventes.



#### UPOZORNĚNÍ

- Návod se pozorně pročtěte, než začnete regulátor instalovat a používat.
- Tato zařízení smí instalovat kvalifikovaní pracovníci v souladu s platnými předpisy a normami pro předcházení úrazu osob či poškození věcí.
- Před jakýmkoli zásahem do přístroje odpojte měřicí a napájecí vstupy od napětí a zkratujte transformátory proudu.
- Výrobce nenese odpovědnost za elektrickou bezpečnost v případě nevhodného používání regulátoru.
- Výrobky popsané v tomto dokumentu mohou kdykoli projít úpravami či dalším vývojem. Popisy a údaje uvedené v katalogu nemají proto žádnou smluvní hodnotu.
- Spínač či odpojovač je nutno zabudovat do elektrického rozvodu v budově. Musejí být nainstalované v těsné blízkosti přístroje a snadno dostupné pracovníku obsluhy. Je nutno ho označit jako vypínač zařízení přístroje: IEC/EN/BS 61010-1 § 6.11.3.1.
- Přístroj čistěte měkkou utěrkou, nepoužívejte abrazivní produkty, tekutá čistidla či rozpouštědla.



#### AVERTIZARE!

- Citiți cu atenție manualul înainte de instalare sau utilizare.
- Acest echipament va fi instalat de personal calificat. În conformitate cu standardele actuale, pentru a evita deteriorări sau pericolele.
- Înainte de efectuarea oricărei operațiuni de întreținere asupra dispozitivului, îndepărtați toate tensiunile de la intrările de măsurare și de alimentare și scurtcircuitați bornele de intrare CT.
- Producătorul nu poate fi considerat responsabil pentru siguranța electrică în caz de utilizare incorectă a echipamentului.
- Produsele ilustrate în prezentul sunt supuse modificărilor și schimbărilor fără notificare anterioară. Datele tehnice și descrierile din documentație sunt precise, în măsura cunoștințelor noastre, dar nu se acceptă nicio răspundere pentru erorile, omisiunile sau evenimentele neprevăzute care apar ca urmare a acestora.
- Trebuie inclus un disjuncteur în instalația electrică a clădirii. Acesta trebuie instalat aproape de echipament și într-o zonă ușor accesibilă operatorului. Acesta trebuie marcat ca fiind dispozitivul de deconectare al echipamentului: IEC/EN/BS 61010-1 § 6.11.3.1.
- Curățați instrumentul cu un material textil moale și uscat; nu utilizați substanțe abrazive, detergenți lichizi sau solvenți.



#### ATTENZIONE!

- Leggere attentamente il manuale prima dell'utilizzo e l'installazione.
- Questi apparecchi devono essere installati da personale qualificato, nel rispetto delle vigenti normative impiantistiche, allo scopo di evitare danni a persone o cose.
- Prima di qualsiasi intervento sullo strumento, togliere tensione dagli ingressi di misura e di alimentazione e cortocircuitare i trasformatori di corrente.
- Il costruttore non si assume responsabilità in merito alla sicurezza elettrica in caso di utilizzo improprio del dispositivo.
- I prodotti descritti in questo documento sono suscettibili in qualsiasi momento di evoluzioni o di modifiche. Le descrizioni ed i dati a catalogo non possono pertanto avere alcun valore contrattuale.
- Un interruttore o disgiuntore va compreso nell'impianto elettrico dell'edificio. Esso deve trovarsi in stretta vicinanza dell'apparecchio ed essere facilmente raggiungibile da parte dell'operatore. Deve essere marchiato come il dispositivo di interruzione dell'apparecchio: IEC/EN/BS 61010-1 § 6.11.3.1.
- Pulire l'apparecchio con panno morbido, non usare prodotti abrasivi, detergenti liquidi o solventi.



#### UWAGA!

- Przed użyciem i instalacją urządzenia należy uważnie przeczytać niniejszą instrukcję.
- W celu uniknięcia obrażeń osób lub uszkodzenia mienia tego typu urządzenia muszą być instalowane przez wykwalifikowany personel, zgodnie z obowiązującymi przepisami.
- Przed rozpoczęciem jakichkolwiek prac na urządzeniu należy odłączyć napięcie od wejść pomiarowych i zasilania oraz zwrzeć zaciski przekładnika prądowego.
- Producent nie przyjmuje na siebie odpowiedzialności za bezpieczeństwo elektryczne w przypadku niewłaściwego użytkowania urządzenia.
- Produkty opisane w niniejszym dokumencie mogą być w każdej chwili udoskonalone lub zmodyfikowane. Opisy oraz dane katalogowe nie mogą mieć w związku z tym żadnej wartości umownej.
- W instalacji elektrycznej budynku należy uwzględnić przelącznik lub wyłącznik automatyczny. Powinien on znajdować się w bliskim sąsiedztwie urządzenia i być łatwo osiągalny przez operatora. Musi być oznaczony jako urządzenie służące do wyłączania urządzenia: IEC/EN/BS 61010-1 § 6.11.3.1.
- Urządzenie należy czyścić miękką szmatką, nie stosować środków ściernych, płynnych detergentów lub rozpuszczalników.



#### 警告!

- 安装或使用前，请仔细阅读本手册。
- 本设备只能由合格人员根据现行标准进行安装，以避免造成损坏或安全危害。
- 对设备进行任何维护操作前，请移除测量输入端和电源输入端的所有电压，并短接 CT 输入端。
- 制造商不负责因设备使用不当导致的电气安全问题。
- 此处说明的产品可能会有变更，恕不提前通知。我们竭力确保本档中技术数据和说明的准确性，但对于错误、遗漏或由此产生的意外事件概不负责。
- 建筑电气系统中必须装有断路器。断路器必须安装在靠近设备且方便操作人员触及的地方。必须将断路器标记为设备的断开装置：IEC/EN 61010-1 § 6.11.3.1
- 请使用柔软的干布清洁设备；切勿使用研磨剂、洗涤剂或溶剂。



#### ПРЕДУПРЕЖДЕНИЕ!

- Прежде чем приступать к монтажу или эксплуатации устройства, внимательно ознакомьтесь с содержанием настоящего руководства.
- Во избежание травм или материального ущерба монтаж должен осуществляться только квалифицированным персоналом в соответствии с действующими нормативами.
- Перед проведением любых работ по техническому обслуживанию устройства необходимо обеспечить все измерительные и питающие входные контакты, а также замкнуть коротко входные контакты трансформатора тока (ТТ).
- Производитель не несет ответственность за обеспечение электробезопасности в случае ненадлежащего использования устройства.
- Изделия, описанные в настоящем документе, в любой момент могут подвергнуться изменениям или усовершенствованиям. Поэтому каталожные данные и описания не могут рассматриваться как действительные с точки зрения контрактов
- Электрическая сеть здания должна быть оснащена автоматическим выключателем, который должен быть расположен вблизи оборудования в пределах доступа оператора. Автоматический выключатель должен быть промаркирован как отключающее устройство оборудования: IEC/EN/BS 61010-1 § 6.11.3.1.
- Очистку устройства производить с помощью мягкой сухой ткани, без применения абразивных материалов, жидких мощных средств или растворителей.



#### DIKKATI!

- Montaj ve kullanımdan önce bu el kitabını dikkatlice okuyunuz.
- Bu aparatlar kişileri veya nesnelere zarar verme ihtimaline karşı yürürlükte olan sistem kurma normlarına göre kalifiye personel tarafından monte edilmelidir
- Aparatı (cihaz) herhangi bir müdahalede bulunmadan önce ölçüm girişindeki gerilimi kesip akım transformatorlerinede kısa baglayıcı degeni haiz değıdir.
- Üretici aparatın hatalı kullanımından kaynaklanan elektriksel güvenliğe ait sorumluluk kabul etmez.
- Bu dokümanda tarif edilen ürünler her an evrimlere veya değışimlere açıktır. Bu sebeple katalogdaki tarif ve değıerler herhangi bir baglayıcı degeni haiz değıdir.
- Binanın elektrik sisteminde bir anahtar veya şalter bulunmalıdır. Bu anahtar veya şalter operatörün kolaylıkla ulaşabileceği yakın bir yerde olmalıdır. Aparatı (cihaz) devreden çıkartma görevi yapan bu anahtar veya şalterin markası: IEC/EN/BS 61010-1 § 6.11.3.1.
- Aparatı (cihaz) sıvı deterjan veya solvent kullanarak yumuşak bir bez ile siliniz aşındırıcı temizlik ürünleri kullanmayınız.



#### UPOZORENJE!

- Prije instalacije ili korištenja uređaja, pažljivo pročitaite upute.
- Ovaj uređaj mora instalirati, u skladu s važećim normama, obučena osoba kako bi se izbjegle štete ili sigurnosne opasnosti.
- Prije bilo kakvog zahvata na uređaju otpojite napajanje s mjernih i napajajućih ulaza i kratko spojite ulazne stezaljke strujnog transformatora.
- Proizvođač ne snosi odgovornost za električnu sigurnost u slučaju nepravilnog korištenja opreme.
- Ovdje prikazan uređaj predmet je stalnog usavršavanja i promjena bez prethodne najave. Tehnički podaci i opisi u ovim uputama su točni, ali ne preuzimamo odgovornost za možebitne nenamjerne greške.
- U električnu instalaciju zgrade mora biti instaliran prekidač. On mora biti instaliran blizu uređaja i na dohvata ruke operatera, te označen kao rastavljač u skladu s normom IEC/EN/BS 61010-1 § 6.11.3.1
- Uredaj čistite s mekom, suhom krpom bez primjene abraziva, tekućina, otapala ili deterđenta.



# 1 General network settings

## Activate network control

In order to be able to control the inverter via network, a trigger must be first assigned in [0x2631:037 \(P400.37\)](#) to the "Activate network control" function.

- This trigger can for instance be the constant value "TRUE" or a digital input.
- If the assigned trigger is = TRUE, the motor can only be started via the network control word (exception: Jog operation).

In case of an activated network control, the following functions are still active:

- [0x2631:001 \(P400.01\)](#): Enable inverter
- [0x2631:002 \(P400.02\)](#): Run
- [0x2631:003 \(P400.03\)](#): Activate quick stop
- [0x2631:004 \(P400.04\)](#): Reset fault
- [0x2631:005 \(P400.05\)](#): Activate DC braking
- [0x2631:010 \(P400.10\)](#): Jog forward (CW)
- [0x2631:011 \(P400.11\)](#): Jog reverse (CCW)
- [0x2631:012 \(P400.12\)](#): Activate keypad control
- [0x2631:037 \(P400.37\)](#): Activate network control
- [0x2631:043 \(P400.43\)](#): Activate fault 1
- [0x2631:044 \(P400.44\)](#): Activate fault 2
- [0x2631:054 \(P400.54\)](#): Position counter reset

All other functions configurable via [0x2631:xx \(P400.xx\)](#) are deactivated in case of network control.

## Network control word and status word

For establishing a simple network connection, the inverter provides predefined control and status words for device profile CiA 402, AC drive profile as well as in LOVATO format.

For implementing your own formats, the data words NetWordIN1 and NetWordOUT1 are available. By means of data mapping to a network register, each of these words can be transferred as process data via network.

Designatio	Parameter	Associated mapping entry *	Further informatio
CiA: Controlword	<a href="#">0x6040</a>	0x60400010	▶ <a href="#">Device profile CiA 402</a>
CiA: Statusword	<a href="#">0x6041 (P780.00)</a>	0x60410010	
AC Drive control word	<a href="#">0x400B:001 (P592.01)</a>	0x400B0110	▶ <a href="#">AC Drive Profile</a>
AC Drive status word	<a href="#">0x400C:001 (P593.01)</a>	0x400C0110	
LECOM control word	<a href="#">0x400B:002 (P592.02)</a>	0x400B0210	▶ <a href="#">LOVATO profile</a>
LECOM status word	<a href="#">0x400C:002 (P593.02)</a>	0x400C0210	
NetWordIN1	<a href="#">0x4008:001 (P590.01)</a>	0x40080110	For implementin an individual control word format. The functions that are to be triggered via bits 0 ... 15 of the NetWordIN1 data word are defined in <a href="#">0x400E:001 (P505.01)</a> ... <a href="#">0x400E:016 (P505.16)</a> .
NetWordOUT1	<a href="#">0x400A:001 (P591.01)</a>	0x400A0110	For implementing an individual status word format. The triggers for bits 0 ... 15 of the NetWordOUT1 data word are defined in <a href="#">0x2634:010 (P420.10)</a> ... <a href="#">0x2634:025 (P420.25)</a> .

\* A mapping entry consists of index, subindex and data length in bits of the parameter to be mapped.

General information about the process of data mapping can be found in the chapter of the same name for the corresponding network.

## Network setpoint

It must be observed that the network setpoint must be selected explicitly. There are various options to select/change-over to the network setpoint. See the following examples.

Example 1: The AC drive control word shall enable a change-over from the standard setpoint source to the network setpoint (bit 6).

1. Set a standard setpoint source different than Network" [5]" in [0x2860:001 \(P201.01\)](#).
2. Set the selection Network setpoint active " [116]" in [0x2631:017 \(P400.17\)](#).

Example 2: Independent of the used network, a change-over from the standard setpoint source to the network setpoint shall be possible via a digital trigger (e. g. digital input).

1. Set a standard setpoint source different than Network" [5]" in [0x2860:001 \(P201.01\)](#).
2. Set the desired digital trigger (e. g. digital input) in [0x2631:017 \(P400.17\)](#) via which the change-over to the network setpoint is to take place.

Example 3: The setpoint is to be defined exclusively via network.

1. As standard setpoint source, set the selection "Network [5]" in [0x2860:001 \(P201.01\)](#).

The following table describes the change-over to the network setpoint via the different network control words in detail:

Network control word	Change-over to network setpoint		
NetWordIN1 data word <a href="#">0x4008:001 (P590.01)</a>	Assign the function "Activate network setpoint [17]" to the bit that is to be used for activating the network setpoint.		
	<ul style="list-style-type: none"> <li>The functions that are to be triggered via bits 0 ... 15 of the NetWordIN1 data word are defined in <a href="#">0x400E:001 (P505.01) ... 0x400E:016 (P505.16)</a>.</li> </ul>		
	Bit x	Selection:	
	0	Standard setpoint source selected in <a href="#">0x2860:001 (P201.01)</a> .	
1	Network setpoint		
AC drive control word <a href="#">0x400B:001 (P592.01)</a>	The network setpoint is activated via bit 6 of the AC Drive control word:		
	Bit 6	Selection:	
	0	Standard setpoint source selected in <a href="#">0x2860:001 (P201.01)</a> .	
	1	Network setpoint	
Note! In order that the activation via bit 6 works, the selection "Network setpoint active [116]" must be set in <a href="#">0x2631:017 (P400.17)</a> .			
LECOM control word <a href="#">0x400B:002 (P592.02)</a>	The setpoint is selected via bit 0 and bit 1 of the LECOM control word:		
	Bit 1	Bit 0	Selection:
	0	0	Standard setpoint source selected in <a href="#">0x2860:001 (P201.01)</a> .
	0	1	Frequency setpoint preset 1 <a href="#">0x2911:001 (P450.01)</a>
	1	0	Frequency setpoint preset 2 <a href="#">0x2911:002 (P450.02)</a>
1	1	Frequency setpoint preset 3 <a href="#">0x2911:003 (P450.03)</a>	
CiA 402 Controlword <a href="#">0x6040</a>	In case of control via device profile CiA 402:		
	<ul style="list-style-type: none"> <li>In the operating mode "CiA: Velocity mode [2]", the setpoint speed defined via the "Target velocity" <a href="#">0x6042 (P781.00)</a> parameter is used. ▶ <a href="#">Device profile CiA 402</a></li> <li>A change-over to an alternative setpoint source via the CiA 402 Controlword is not possible.</li> </ul>		



If a bipolar network setpoint is specified for the operating mode "MS: Velocity mode" (e. g. via the mappable parameter [0x400B:006 \(P592.06\)](#)), the direction of rotation cannot be controlled via the network control word. The direction of rotation is determined by the sign of the setpoint.

Parameter	Name / value range / [default setting]	Info
0x231F:001 (P500.01)	Module ID: Active module ID (Module ID: Active module ID) • Read only	Display of the network options currently configured in the inverter. • With the help of this module ID, the keypad only shows the communication parameters relevant to the respective network.  <b>Note!</b> When switched on, the inverter checks whether the parameter settings saved in the memory module match the inverter hardware and firmware. In case of an incompatibility, a corresponding error message is output.
	48 No network	
	67 CANopen	
	80 PROFIBUS	
	82 PROFINET	
	84 EtherCAT	
87 Modbus RTU		
0x231F:002 (P500.02)	Module ID: Module ID connected (Module ID: Module ID conn.) • Read only • For the meaning of the display see parameter <a href="#">0x231F:001 (P500.01)</a> .	Display of the network option currently available in the inverter.  <b>Note!</b> When switched on, the inverter checks whether the parameter settings saved in the memory module match the inverter hardware and firmware. In case of an incompatibility, a corresponding error message is output.
0x400E:001 (P505.01)	NetWordIN1 function Bit 0 (NetWordIN1 fct.: NetWordIN1.00) • Setti can only be changed if the inverter is inhibited.	Definition of the function that is to be triggered via bit 0 of the mappable NetWordIN1 data word.
	<b>0 Not activ</b>	Trigger bit without any function
	1 Disable inverter	Trigger bit = 0-1 edge: The inverter is disabled. Trigger bit = 0: The inverter is enabled (unless there is another cause for inverter disable).  <b>Notes:</b> <ul style="list-style-type: none"> <li>In all device states, a 0-1 edge causes an immediate change to the inhibited state with one exception. If the inverter is in the error status and the error condition still exists, the inverter remains in the error status.</li> <li>Changing to the disabled state causes an immediate stop of the motor, regardless of the stop method set in <a href="#">0x2838:003 (P203.03)</a>. The motor coasts down as a function of the mass inertia of the machine.</li> <li>In the disabled state, the motor cannot be started.</li> <li>After the inverter disable is deactivated, a renewed start command is required to restart the motor.</li> <li>The cause(s) that are active for the disabled state are shown in <a href="#">0x282A:001 (P126.01)</a>.</li> </ul>
	2 Stopping	Trigger bit = 1: Motor is stopped. Trigger bit = 0: No action / Deactivate stop again.  <b>Notes:</b> <ul style="list-style-type: none"> <li>The stop method can be selected in <a href="#">0x2838:003 (P203.03)</a>.</li> </ul>
	3 Activate quick stop	Trigger bit = 1: "Quick stop" function activated. Trigger bit = 0: no action / deactivate function again.  <b>Notes:</b> <ul style="list-style-type: none"> <li>The "Quick stop" function brings the motor to a standstill within the deceleration time set in <a href="#">0x291C (P225.00)</a>.</li> <li>The "Quick stop" function has a higher priority than the "Run" function.</li> </ul>

Parameter	Name / value range / [default setting]	Info
	4 Reset error	Trigger bit = 0-1 edge: Active error is reset (acknowledged) if the error condition is not active anymore and the error is resettable Trigger bit = 0: No action.  Notes: • After resetting the error, a new enable/start command is required to restart the motor.
	5 Activate DC braking	Trigger bit = 1: "DC braking" function activated. Trigger bit = 0: no action / deactivate function again.
	8 Run forward (CW)	Trigger bit = 0-1 edge: Motor is started in forward rotating direction (CW). Trigger bit = 1-0 edge: Motor is stopped again.  Notes: • The stop method can be selected in <a href="#">0x2838:003 (P203.03)</a> . • In the case of a bipolar setpoint selection (e.g $\pm 10$ V), the function is executed irrespective of the rotating direction. The rotating direction is determined by the sign of the setpoint. • The function also serves to realise an automatic start after switch-on.  • The "Reverse rotational direction [13]" function can be used in connection with this function.
	9 Run reverse (CCW)	Trigger bit = 0-1 edge: Motor is started in backward rotating direction (CCW). Trigger bit = 1-0 edge: Motor is stopped again.  Notes: • The stop method can be selected in <a href="#">0x2838:003 (P203.03)</a> . • In the case of a bipolar setpoint selection (e.g $\pm 10$ V), the function is executed irrespective of the rotating direction. The rotating direction is determined by the sign of the setpoint. • The function also serves to realise an automatic start after switch-on.  • The "Reverse rotational direction [13]" function can be used in connection with this function.
	13 Reverse rotational direction	Trigger bit = 1: the setpoint specified is inverted (i. e. the sign is inverted). Trigger bit = 0: no action / deactivate function again.
	14 Activate AI1 setpoint	Trigger bit = 1: analog input 1 is used as setpoint source (if the trigger bit assigned has the highest setpoint priority). Trigger bit = 0: no action / deactivate function again.
	15 Activate AI2 setpoint	Trigger bit = 1: analog input 2 is used as setpoint source (if the trigger bit assigned has the highest setpoint priority). Trigger bit = 0: no action / deactivate function again.
	17 Activate network setpoint	Trigger bit = 1: the network is used as setpoint source (if the trigger bit assigned has the highest setpoint priority). Trigger bit = 0: no action / deactivate function again.
	18 Activate preset (bit 0)	Selection bits for bit coded selection and activation of a parameterised setpoint (preset).
	19 Activate preset (bit 1)	
	20 Activate preset (bit 2)	
	21 Activate preset (bit 3)	
	26 Activate segment 1 setpoint (from version 4.1)	Selection bits for bit coded selection and activation of a parameterised segment setpoint.  Notes: • During normal operation (no active sequence), this function serves to activate the setpoint of a segment (instead of an entire sequence in the sequencer operation). • This function is not intended for the use in the sequencer operation.
	27 Activate segment 2 setpoint (from version 4.1)	
	28 Activate segment 3 setpoint (from version 4.1)	
	29 Activate segment 4 setpoint (from version 4.1)	

Parameter	Name / value range / [default setting]	Info
	30 Run/abort sequence (from version 4.1)	<p>Trigger bit = 1: Start selected sequence. Trigger bit = 0: Abort sequence.</p> <p>Notes:</p> <ul style="list-style-type: none"> <li>The assigned trigger bit must remain set to "1" for the duration of the sequence.</li> <li>If the trigger bit is reset to "0", the sequence is aborted. In this case, the standard setpoint or the setpoint source selected via setpoint change-over is active again.</li> <li>A sequence is selected in a binary-coded fashion via the trigger bits assigned to the four functions "Select sequence (bit 0) [50]" ... "Select sequence (bit 3) [53]".</li> </ul>
	32 Next sequence step (from version 4.1)	<p>Trigger bit = 0↗1 (edge): Next sequence step. Trigger bit = 1↘0 (edge): No action.</p> <p>Notes:</p> <ul style="list-style-type: none"> <li>The execution of the current step is completed even if the time parameterised for the segment has not elapsed yet.</li> <li>The function is only relevant for Sequencer mode 0x4025 (P800.00) = "Step operation [2]" or "Time &amp; step operation [3]".</li> <li>A jump to the next sequence step is not possible if the sequence pauses, the sequence is suspended or the final segment is executed.</li> </ul>
	33 Pause sequence (from version 4.1)	<p>Trigger bit = 1: Pause sequence. Trigger bit = 0: Continue sequence.</p> <p>Notes:</p> <ul style="list-style-type: none"> <li>During the pause, the sequence stops in the current step. The expiration of the time set for the segment is stopped.</li> <li>The sequencer setpoint continues to remain active.</li> </ul>
	34 Suspend sequence (from version 4.1)	<p>Trigger bit = 1: Suspend sequence. Trigger bit = 0: Continue sequence.</p> <p>Notes:</p> <ul style="list-style-type: none"> <li>This function serves to temporarily change over to the standard setpoint or the setpoint source selected via setpoint change-over.</li> <li>The sequence is continued at the point where it was suspended.</li> </ul>
	35 Stop sequence (from version 4.1)	<p>Trigger bit = 0↗1 (edge): Stop sequence. Trigger bit = 1↘0 (edge): No action.</p> <p>Notes:</p> <ul style="list-style-type: none"> <li>If the sequence is stopped, it is jumped to the final segment.</li> <li>The further execution depends on the selected End of sequence mode 0x402F (P824.00).</li> </ul>
	36 Abort sequence (from version 4.1)	<p>Trigger bit = 0↗1 (edge): Abort sequence. Trigger bit = 1↘0 (edge): No action.</p> <p>Notes:</p> <ul style="list-style-type: none"> <li>This function serves to directly stop the sequence without the final segment being executed. In this case, the standard setpoint or the setpoint source selected via setpoint change-over is active again.</li> </ul>
	39 Activate ramp 2	<p>Trigger bit = 1: activate acceleration time 2 and deceleration time 2 manually. Trigger bit = 0: no action / deactivate function again.</p>
	40 Load parameter set	<p>Trigger bit = 0-1 edge: parameter change-over to the value set selected via "Select parameter set (bit 0)" and "Select parameter set (bit 1)". Trigger bit = 0: no action.</p> <p>Notes:</p> <ul style="list-style-type: none"> <li>The activation method for the "Parameter change-over" function can be selected in 0x4046 (P755.00).</li> </ul>

Parameter	Name / value range / [default setting]	Info
41	Select parameter set (bit 0)	Selection bits for the "Parameter change-over" function.
42	Select parameter set (bit 1)	
43	Activate fault 1	<p>Trigger bit = 1: Trigger user-defined error 1. Trigger bit = 0: no action.</p> <p>Notes:</p> <ul style="list-style-type: none"> <li>After the error is triggered, the motor is brought to a standstill with the quick stop ramp. The inverter is then disabled.</li> </ul> <p>Associated error code:</p> <ul style="list-style-type: none"> <li>25249   0x62A1 - Network: user fault 1</li> </ul>
44	Activate fault 2	<p>Trigger bit = 1: Trigger user-defined error 2. Trigger bit = 0: no action.</p> <p>Notes:</p> <ul style="list-style-type: none"> <li>After the error is triggered, the motor is brought to a standstill with the quick stop ramp. The inverter is then disabled.</li> </ul> <p>Associated error code:</p> <ul style="list-style-type: none"> <li>25250   0x62A2 - Network: user fault 2</li> </ul>
45	Deactivate PID controlling	<p>Trigger bit = 1: If PID control is activated, ignore PID control and drive the motor in speed-controlled manner. Trigger bit = 0: If PID control is activated, drive the motor with PID control.</p> <p>Notes:</p> <ul style="list-style-type: none"> <li>The PID control can be activated in 0x4020:001 (P600.01).</li> </ul>
46	Set PID output to 0	<p>Trigger bit = 1: If PID control is activated, I component and the output of the PID controller are set to 0 and the internal control algorithm is stopped. The PID control remains active. Trigger bit = 0: No action / deactivate function again.</p>
47	Inhibit PID I-component	<p>Trigger bit = 1: If the PID control is activated, the I component of the PID controller is set to 0 and the integration process is stopped. Trigger bit = 0: No action / deactivate function again.</p>
48	Activate PID influence ramp	<p>Trigger bit = 1: the influence of the process controller is shown by means of a ramp. Trigger bit = 0 or not connected: the influence of the process controller is shown by means of a ramp.</p> <p>Notes:</p> <ul style="list-style-type: none"> <li>The influence of the process controller is always active (not only when PID control is activated)</li> <li>Acceleration time for showing the influence of the process controller can be set in 0x404C:001 (P607.01).</li> <li>Deceleration time for hiding the influence of the process controller can be set in 0x404C:002 (P607.02).</li> </ul>
49	Release holding brake	<p>Trigger bit = 1: Release holding brake manually. Trigger bit = 0: No action.</p> <p>Notes:</p> <ul style="list-style-type: none"> <li>The manually triggered "Release holding brake" command has a direct impact on the "Release holding brake [115]" trigger. Thus, the holding brake can be manually released if the power section is switched off</li> <li>The responsibility for a manual release of the holding brake has the external trigger source for the "Release holding brake" command.</li> </ul>
50	Select sequence (bit 0)	<p>Selection bits for bit coded selection of a sequence.</p> <p>Notes:</p> <ul style="list-style-type: none"> <li>The selected sequence is not started automatically.</li> <li>For a status-controlled start, the function "Run/abort sequence [30]" is available.</li> </ul>
51	Select sequence (bit 1)	
52	Select sequence (bit 2)	
53	Select sequence (bit 3)	



Parameter	Name / value range / [default setting]	Info
	54 Position counter reset	Trigger bit = 1: Reset position counter manually. Trigger bit = 0: No action.
	55 Activate UPS operation	Trigger bit = 1: Activate UPS operation. Trigger bit = 0: No action / deactivate function again.
0x400E:002 (P505.02)	NetWordIN1 function: Bit 1 (NetWordIN1 fct.: NetWordIN1.01) <ul style="list-style-type: none"> <li>Setting can only be changed if the inverter is inhibited.</li> <li>For further possible settings, see parameter <a href="#">0x400E:001 (P505.01)</a>.</li> </ul>	Definition of the function that is to be triggered via bit 1 of the mappable NetWordIN1 data word.
	<b>0</b> Not active	
0x400E:003 (P505.03)	NetWordIN1 function: Bit 2 (NetWordIN1 fct.: NetWordIN1.02) <ul style="list-style-type: none"> <li>Setting can only be changed if the inverter is inhibited.</li> <li>For further possible settings, see parameter <a href="#">0x400E:001 (P505.01)</a>.</li> </ul>	Definition of the function that is to be triggered via bit 2 of the mappable NetWordIN1 data word.
	<b>3</b> Activate quick stop	
0x400E:004 (P505.04)	NetWordIN1 function: Bit 3 (NetWordIN1 fct.: NetWordIN1.03) <ul style="list-style-type: none"> <li>Setting can only be changed if the inverter is inhibited.</li> <li>For further possible settings, see parameter <a href="#">0x400E:001 (P505.01)</a>.</li> </ul>	Definition of the function that is to be triggered via bit 3 of the mappable NetWordIN1 data word.
	<b>0</b> Not active	
0x400E:005 (P505.05)	NetWordIN1 function: Bit 4 (NetWordIN1 fct.: NetWordIN1.04) <ul style="list-style-type: none"> <li>Setting can only be changed if the inverter is inhibited.</li> <li>For further possible settings, see parameter <a href="#">0x400E:001 (P505.01)</a>.</li> </ul>	Definition of the function that is to be triggered via bit 4 of the mappable NetWordIN1 data word.
	<b>8</b> Run forward (CW)	
0x400E:006 (P505.06)	NetWordIN1 function: Bit 5 (NetWordIN1 fct.: NetWordIN1.05) <ul style="list-style-type: none"> <li>Setting can only be changed if the inverter is inhibited.</li> <li>For further possible settings, see parameter <a href="#">0x400E:001 (P505.01)</a>.</li> </ul>	Definition of the function that is to be triggered via bit 5 of the mappable NetWordIN1 data word.
	<b>18</b> Activate preset (bit 0)	
0x400E:007 (P505.07)	NetWordIN1 function: Bit 6 (NetWordIN1 fct.: NetWordIN1.06) <ul style="list-style-type: none"> <li>Setting can only be changed if the inverter is inhibited.</li> <li>For further possible settings, see parameter <a href="#">0x400E:001 (P505.01)</a>.</li> </ul>	Definition of the function that is to be triggered via bit 6 of the mappable NetWordIN1 data word.
	<b>19</b> Activate preset (bit 1)	
0x400E:008 (P505.08)	NetWordIN1 function: Bit 7 (NetWordIN1 fct.: NetWordIN1.07) <ul style="list-style-type: none"> <li>Setting can only be changed if the inverter is inhibited.</li> <li>For further possible settings, see parameter <a href="#">0x400E:001 (P505.01)</a>.</li> </ul>	Definition of the function that is to be triggered via bit 7 of the mappable NetWordIN1 data word.
	<b>4</b> Reset error	
0x400E:009 (P505.09)	NetWordIN1 function Bit 8 (NetWordIN1 fct.: NetWordIN1.08) <ul style="list-style-type: none"> <li>Setting can only be changed if the inverter is inhibited.</li> <li>For further possible settings, see parameter <a href="#">0x400E:001 (P505.01)</a>.</li> </ul>	Definition of the function that is to be triggered via bit 8 of the mappable NetWordIN1 data word.
	<b>0</b> Not active	







Parameter	Name / value range / [default setting]	Info
0x400E:010 (P505.10)	NetWordIN1 function: Bit 9 (NetWordIN1 fct.: NetWordIN1.09) <ul style="list-style-type: none"> <li>Setting can only be changed if the inverter is inhibited.</li> <li>For further possible settings, see parameter <a href="#">0x400E:001 (P505.01)</a>.</li> </ul>	Definition of the function that is to be triggered via bit 9 of the mappable NetWordIN1 data word.
	<b>5</b>   <b>Activate DC braking</b>	
0x400E:011 (P505.11)	NetWordIN1 function: Bit 10 (NetWordIN1 fct.: NetWordIN1.10) <ul style="list-style-type: none"> <li>Setting can only be changed if the inverter is inhibited.</li> <li>For further possible settings, see parameter <a href="#">0x400E:001 (P505.01)</a>.</li> </ul>	Definition of the function that is to be triggered via bit 10 of the mappable NetWordIN1 data word.
	<b>0</b>   <b>Not active</b>	
0x400E:012 (P505.12)	NetWordIN1 function: Bit 11 (NetWordIN1 fct.: NetWordIN1.11) <ul style="list-style-type: none"> <li>Setting can only be changed if the inverter is inhibited.</li> <li>For further possible settings, see parameter <a href="#">0x400E:001 (P505.01)</a>.</li> </ul>	Definition of the function that is to be triggered via bit 11 of the mappable NetWordIN1 data word.
	<b>0</b>   <b>Not active</b>	
0x400E:013 (P505.13)	NetWordIN1 function: Bit 12 (NetWordIN1 fct.: NetWordIN1.12) <ul style="list-style-type: none"> <li>Setting can only be changed if the inverter is inhibited.</li> <li>For further possible settings, see parameter <a href="#">0x400E:001 (P505.01)</a>.</li> </ul>	Definition of the function that is to be triggered via bit 12 of the mappable NetWordIN1 data word.
	<b>13</b>   <b>Reverse rotational direction</b>	
0x400E:014 (P505.14)	NetWordIN1 function: Bit 13 (NetWordIN1 fct.: NetWordIN1.13) <ul style="list-style-type: none"> <li>Setting can only be changed if the inverter is inhibited.</li> <li>For further possible settings, see parameter <a href="#">0x400E:001 (P505.01)</a>.</li> </ul>	Definition of the function that is to be triggered via bit 13 of the mappable NetWordIN1 data word.
	<b>0</b>   <b>Not active</b>	
0x400E:015 (P505.15)	NetWordIN1 function: Bit 14 (NetWordIN1 fct.: NetWordIN1.14) <ul style="list-style-type: none"> <li>Setting can only be changed if the inverter is inhibited.</li> <li>For further possible settings, see parameter <a href="#">0x400E:001 (P505.01)</a>.</li> </ul>	Definition of the function that is to be triggered via bit 14 of the mappable NetWordIN1 data word.
	<b>0</b>   <b>Not active</b>	
0x400E:016 (P505.16)	NetWordIN1 function: Bit 15 (NetWordIN1 fct.: NetWordIN1.15) <ul style="list-style-type: none"> <li>Setting can only be changed if the inverter is inhibited.</li> <li>For further possible settings, see parameter <a href="#">0x400E:001 (P505.01)</a>.</li> </ul>	Definition of the function that is to be triggered via bit 15 of the mappable NetWordIN1 data word.
	<b>0</b>   <b>Not active</b>	
0x2631:001 (P400.01)	Function list: Enable inverter (Function list: Enable inverter) <ul style="list-style-type: none"> <li>Setting can only be changed if the inverter is inhibited.</li> </ul>	Assignment of a trigger for the "Enable inverter" function. Trigger = TRUE: The inverter is enabled (unless there is another cause for inverter disable). Trigger = FALSE: The inverter is disabled.  Notes: <ul style="list-style-type: none"> <li>This function must be set to TRUE to start the motor. Either via an assigned digital input or by default setting "Constant TRUE [1]".</li> <li>Changing to the inhibited state causes an immediate stop of the motor, regardless of the stop method set in <a href="#">0x2838:003 (P203.03)</a>. The motor becomes torqueless and coasts down as a function of the mass inertia of the machine.</li> <li>The cause(s) that are active for the disabled state are shown in <a href="#">0x282A:001 (P126.01)</a>.</li> </ul>
	<b>0</b>   <b>Not connected</b>	

Parameter	Name / value range / [default setting]	Info
	<b>1 Constant TRUE</b>	Trigger is constantly TRUE.
11	Digital input 1	State of X3/DI1, taking an inversion set in <a href="#">0x2632:001 (P411.01)</a> into consideration.
12	Digital input 2	State of X3/DI2, taking an inversion set in <a href="#">0x2632:002 (P411.02)</a> into consideration.
13	Digital input 3	State of X3/DI3, taking an inversion set in <a href="#">0x2632:003 (P411.03)</a> into consideration.
14	Digital input 4	State of X3/DI4, taking an inversion set in <a href="#">0x2632:004 (P411.04)</a> into consideration.
15	Digital input 5	State of X3/DI5, taking an inversion set in <a href="#">0x2632:005 (P411.05)</a> into consideration.
16	Digital input 6	State of X3/DI6, taking an inversion set in <a href="#">0x2632:006 (P411.06)</a> into consideration. Digital input 6 is only available in the Control Unit (CU) with applicatio I/O.
17	Digital input 7	State of X3/DI7, taking an inversion set in <a href="#">0x2632:007 (P411.07)</a> into consideration Digital input 7 is only available in the Control Unit (CU) with applicatio I/O.
50	Running	TRUE if inverter and start are enabled and output frequency > 0.2 Hz. Otherwise FALSE.
51	Ready for operation	TRUE if inverter is ready for operation (no error active, no STO active and DC-bus voltage ok). Otherwise FALSE.
53	Stop active	TRUE if inverter is enabled and motor is not started and output frequency = 0.
54	Quick stop active	TRUE if quick stop is active. Otherwise FALSE.
58	Device warning active	TRUE if warning is active. Otherwise FALSE. <ul style="list-style-type: none"> <li>A warning has no impact on the operating status of the inverter.</li> <li>A warning is reset automatically if the cause has been eliminated.</li> </ul>
59	Device fault active	TRUE if a fault is active. Otherwise FALSE. <ul style="list-style-type: none"> <li>In the event of a fault, the motor is brought to a standstill with the quick stop ramp. The inverter is then disabled.</li> <li>Exception: In case of a serious fault, the inverter is disabled immediately. The motor becomes torqueless (coasts).</li> <li>The error state will be left automatically if the error condition is not active anymore.</li> <li>The restart behaviour after trouble can be configured.</li> </ul>
60	Heatsink temperature warning active	TRUE if current heatsink temperature > warning threshold for temperature monitoring. Otherwise FALSE. <ul style="list-style-type: none"> <li>Display of the current heatsink temperature in <a href="#">0x2D84:001 (P117.01)</a>.</li> <li>Setting of the warning threshold in <a href="#">0x2D84:002</a>.</li> </ul>
69	Rotational direction reversed	TRUE if output frequency is negative. Otherwise FALSE.
70	Frequency threshold exceeded	TRUE if current output frequency > frequency threshold. Otherwise FALSE. <ul style="list-style-type: none"> <li>Display of the current output frequency in <a href="#">0x2DDD (P100.00)</a>.</li> <li>Setting Frequency threshold in <a href="#">0x4005 (P412.00)</a>.</li> </ul>
71	Actual speed = 0	TRUE if current output frequency = 0 Hz ( $\pm 0.01$ Hz), irrespective of the operating mode. Otherwise FALSE. <ul style="list-style-type: none"> <li>Display of the current output frequency in <a href="#">0x2DDD (P100.00)</a>.</li> </ul>
78	Current limit reached	TRUE if current motor current $\geq$ maximum current. Otherwise FALSE. <ul style="list-style-type: none"> <li>Display of the present motor current in <a href="#">0x2D88 (P104.00)</a>.</li> <li>Setting for the maximum current in <a href="#">0x6073 (P324.00)</a>.</li> </ul>
79	Torque limit reached	TRUE if torque limit has been reached or exceeded. Otherwise FALSE. <ul style="list-style-type: none"> <li>Setting "Positive torque limit" in <a href="#">0x60E0</a>.</li> <li>Setting "Negative torque limit" in <a href="#">0x60E1</a>.</li> </ul>

Parameter	Name / value range / [default setting]	Info
81	Error of analog input 1 active	TRUE if the monitoring of the input signal at the analog input 1 has responded. Otherwise FALSE. This trigger is set as a function of the following settings: <ul style="list-style-type: none"> <li>Monitoring threshold <a href="#">0x2636:008 (P430.08)</a></li> <li>Monitoring condition <a href="#">0x2636:009 (P430.09)</a></li> </ul> The setting of the Error response in <a href="#">0x2636:010 (P430.10)</a> has no effect on this trigger.
82	Error of analog input 2 active	TRUE if the monitoring of the input signal at the analog input 2 has responded. Otherwise FALSE. This trigger is set as a function of the following settings: <ul style="list-style-type: none"> <li>Monitoring threshold <a href="#">0x2637:008 (P431.08)</a></li> <li>Monitoring condition <a href="#">0x2637:009 (P431.09)</a></li> </ul> The setting of the Error response in <a href="#">0x2637:010 (P431.10)</a> has no effect on this trigger.
83	Load loss detected	TRUE if actual motor current < threshold for load loss detection after delay time of the load loss detection has elapsed. Otherwise FALSE. <ul style="list-style-type: none"> <li>Display of the present motor current in <a href="#">0x6078 (P103.00)</a>.</li> <li>Setting Threshold in <a href="#">0x4006:001 (P710.01)</a>.</li> <li>Setting Deceleration in <a href="#">0x4006:002 (P710.02)</a>.</li> </ul>
102	Sequence suspended (from version 4.1)	Status signal of the "sequencer" function. TRUE if the sequence is currently suspended.
103	Sequence done (from version 4.1)	Status signal of the "sequencer" function. TRUE if the sequence is completed (final segment has been passed through).
104	Local control active	TRUE if local keypad control ("LOC") active. Otherwise FALSE.
105	Remote control active	TRUE if remote control ("REM") via terminals, network, etc. active. Otherwise FALSE.
106	Manual setpoint selection active	TRUE if manual setpoint selection ("MAN") via keypad active. Otherwise FALSE. <ul style="list-style-type: none"> <li>Selection of the trigger for the "Activate keypad setpoint" function in <a href="#">0x2631:016 (P400.16)</a>.</li> </ul>
107	Automatic setpoint selection active	TRUE if automatic setpoint selection ("AUTO") via terminals, network, etc. active. Otherwise FALSE.
201	Internal value (from version 5.1)	Internal values of the manufacturer.
202	Internal value (from version 5.1)	
203	Internal value (from version 5.1)	
204	Internal value (from version 5.1)	
205	Internal value (from version 5.1)	
206	Internal value (from version 5.1)	

Parameter	Name / value range / [default setting]	Info
0x2631:002 (P400.02)	Function list: Run (Function list: Run) <ul style="list-style-type: none"> <li>Setting can only be changed if the inverter is inhibited.</li> <li>For further possible settings, see parameter <a href="#">0x2631:001 (P400.01)</a>.</li> </ul>	Assignment of a trigger to the "Run" function.  <b>Function 1: Start / stop motor (default setting)</b> Function 1 is active if no further start commands (start forward/start reverse) have been connected to triggers, no keypad control is active and no network control is active Trigger = TRUE: Let motor rotate forward (CW). Trigger = FALSE: Stop motor.  Notes to function 1: <ul style="list-style-type: none"> <li>If "Enable inverter" <a href="#">0x2631:001 (P400.01)</a> = "Constant TRUE [1]", only a digital input is permissible as trigger for this function in order that the motor can be stopped again any time.                Exception If the "Safe torque o (STO)" safety function is available, both function "Enable inverter" and "Run" can be set to "Constant TRUE [1]". The inverter is then controlled via the STO signal unless no other start commands (start-forward/start-backward) have been connected to triggers.</li> <li>The stop method can be selected in <a href="#">0x2838:003 (P203.03)</a>.</li> <li>The function also serves to realise an automatic start after switch-on.</li> </ul>
	<b>11 Digital input 1</b>	<b>Function 2: Start enable/stop motor</b> Function 2 is active if further start commands have been connected to triggers, keypad control is active or network control is active. Trigger = TRUE: Start commands of the active control source are enabled. Trigger = FALSE: Stop motor.  Notes to function 2: <ul style="list-style-type: none"> <li>If no separate start enable is required for the application, the trigger "Constant TRUE [1]" must be set.</li> <li>The stop method can be selected in <a href="#">0x2838:003 (P203.03)</a>.</li> </ul>
0x2631:003 (P400.03)	Function list: Activate quick stop (Function list: Quick stop) <ul style="list-style-type: none"> <li>Setting can only be changed if the inverter is inhibited.</li> <li>For further possible settings, see parameter <a href="#">0x2631:001 (P400.01)</a>.</li> </ul>	Assignment of a trigger for the "Activate quick stop" function. Trigger = TRUE: Activate quick stop. Trigger = FALSE: Deactivate quick stop.  Notes: <ul style="list-style-type: none"> <li>The "Quick stop" function brings the motor to a standstill within the deceleration time set in <a href="#">0x291C (P225.00)</a>.</li> </ul>
	<b>0 Not connected</b>	
0x2631:004 (P400.04)	Function list: Reset fault (Function list: Reset fault) <ul style="list-style-type: none"> <li>For further possible settings, see parameter <a href="#">0x2631:001 (P400.01)</a>.</li> </ul>	Assignment of a trigger for the "Reset fault" function. Trigger = FALSE↗TRUE (edge): Active error is reset (acknowledged) if the error condition is not active anymore and the error is resettable. Trigger = FALSE: no action
	<b>12 Digital input 2</b>	
0x2631:005 (P400.05)	Function list: Activate DC braking (Function list: DC braking) <ul style="list-style-type: none"> <li>For further possible settings, see parameter <a href="#">0x2631:001 (P400.01)</a>.</li> </ul>	Assignment of a trigger for the "Activate DC braking" function. Trigger = TRUE: Activate DC braking. Trigger = FALSE: Deactivate DC braking.
	<b>0 Not connected</b>	 CAUTION! DC braking remains active as long as the trigger is set to TRUE.

Parameter	Name / value range / [default setting]	Info
0x2631:010 (P400.10)	Function list: Jog forward (CW) (Function list: Jog forward) <ul style="list-style-type: none"> <li>Setting can only be changed if the inverter is inhibited.</li> <li>For further possible settings, see parameter <a href="#">0x2631:001 (P400.01)</a>.</li> </ul>	Assignment of a trigger for the "Jog forward (CW)" function. Trigger = TRUE: Let motor rotate forward with preset 5. Trigger = FALSE: Stop motor.  <b>CAUTION!</b> The jog operation has a higher priority than the "Run" function, all other start commands and the keypad key  . <ul style="list-style-type: none"> <li>If jog operation is active, the motor cannot be stopped with the previously mentioned functions!</li> <li>However, jog operation can be interrupted by the "Quick stop" function.</li> </ul> Notes: <ul style="list-style-type: none"> <li>The preset value 5 can be set in <a href="#">0x2911:005 (P450.05)</a>.</li> <li>The stop method can be selected in <a href="#">0x2838:003 (P203.03)</a>.</li> <li>If "Jog forward (CW)" and "Jog reverse (CCW)" are activated at the same time, the motor is stopped using the stop method and jog operation must be triggered again.</li> <li>Jog operation cannot be started automatically. The "Start at power-up" option in <a href="#">0x2838:002 (P203.02)</a> does not apply to jog operation.</li> </ul>
	<b>0</b> Not connected	
0x2631:011 (P400.11)	Function list: Jog reverse (CCW) (Function list: Jog reverse) <ul style="list-style-type: none"> <li>Setting can only be changed if the inverter is inhibited.</li> <li>For further possible settings, see parameter <a href="#">0x2631:001 (P400.01)</a>.</li> </ul>	Assignment of a trigger for the "Jog reverse (CCW)" function. Trigger = TRUE: Let motor rotate backward with preset 6. Trigger = FALSE: Stop motor.  <b>CAUTION!</b> The jog operation has a higher priority than the "Run" function, all other start commands and the keypad key  . <ul style="list-style-type: none"> <li>If jog operation is active the motor cannot be stopped with the previously mentioned functions!</li> <li>However, jog operation can be interrupted by the "Quick stop" function.</li> </ul> Notes: <ul style="list-style-type: none"> <li>The preset value 6 can be set in <a href="#">0x2911:006 (P450.06)</a>.</li> <li>The stop method can be selected in <a href="#">0x2838:003 (P203.03)</a>.</li> <li>If "Jog forward (CW)" and "Jog reverse (CCW)" are activated at the same time, the motor is stopped using the stop method and jog operation must be triggered again.</li> <li>Jog operation cannot be started automatically. The "Start at power-up" option in <a href="#">0x2838:002 (P203.02)</a> does not apply to jog operation.</li> </ul>
	<b>0</b> Not connected	
0x2631:012 (P400.12)	Function list: Activate keypad control (Function list: Keypad control) <ul style="list-style-type: none"> <li>For further possible settings, see parameter <a href="#">0x2631:001 (P400.01)</a>.</li> </ul>	Assignment of a trigger for the "Activate keypad control" function. Trigger = TRUE: activate keypad as control source. Trigger = FALSE: no action / deactivate keypad as control source again.
	<b>0</b> Not connected	
0x2631:017 (P400.17)	Function list: Activate network setpoint (Function list: Setp: Network) <ul style="list-style-type: none"> <li>For further possible settings, see parameter <a href="#">0x2631:001 (P400.01)</a>.</li> </ul>	Assignment of a trigger for the "Activate network setpoint" function. Trigger = TRUE: the network is used as setpoint source (if the trigger assigned has the highest setpoint priority). Trigger = FALSE: no action / deactivate function again.
	<b>0</b> Not connected	
	116	Network setpoint active

Parameter	Name / value range / [default setting]	Info
0x2631:037 (P400.37)	Function list: Activate network control (Function list: Network control) • For further possible settings, see parameter <a href="#">0x2631:001 (P400.01)</a> .	Assignment of a trigger for the "Activate network control" function. Trigger = TRUE: Activate network control. Trigger = FALSE: No action / deactivate network control again.
	<b>0 Not connected</b>	
	114 Network control active	TRUE if the network control is requested via bit 5 of the AC drive control word <a href="#">0x400B:001 (P592.01)</a> . Otherwise FALSE.  Notes: • Set this selection if the network control is to be activated via bit 5 of the AC drive control word. • The AC drive control word can be used with any communication protocol.
0x2631:043 (P400.43)	Function list: Activate fault 1 (Function list: Fault 1) • For further possible settings, see parameter <a href="#">0x2631:001 (P400.01)</a> .	Assignment of a trigger for the "Activate fault 1" function. Trigger = TRUE: Trigger user-defined error 1. Trigger = FALSE: no action.  Notes: • After the error is triggered, the motor is brought to a standstill with the quick stop ramp. The inverter is then disabled.  Associated error code: • <a href="#">25217</a>   <a href="#">0x6281</a> - User-defined fault 1.
	<b>0 Not connected</b>	
0x2631:044 (P400.44)	Function list: Activate fault 2 (Function list: Fault 2) • For further possible settings, see parameter <a href="#">0x2631:001 (P400.01)</a> .	Assignment of a trigger for the "Activate fault 2" function. Trigger = TRUE: Trigger user-defined error 2. Trigger = FALSE: no action.  Notes: • After the error is triggered, the motor is brought to a standstill with the quick stop ramp. The inverter is then disabled.  Associated error code: • <a href="#">25218</a>   <a href="#">0x6282</a> - User-defined fault 2.
	<b>0 Not connected</b>	
0x2634:010 (P420.10)	Digital outputs function: NetWordOUT1 - bit 0 (Dig.out.function: NetWordOUT1.00) • For further possible settings, see parameter <a href="#">0x2634:001 (P420.01)</a> .	Assignment of a trigger to bit 0 of NetWordOUT1. Trigger = FALSE: bit set to 0. Trigger = TRUE: bit set to 1.
	<b>51 Ready for operation</b>	
0x2634:011 (P420.11)	Digital outputs function: NetWordOUT1 - bit 1 (Dig.out.function: NetWordOUT1.01) • For further possible settings, see parameter <a href="#">0x2634:001 (P420.01)</a> .	Assignment of a trigger to bit 1 of NetWordOUT1. Trigger = FALSE: bit set to 0. Trigger = TRUE: bit set to 1.
	<b>0 Not connected</b>	
0x2634:012 (P420.12)	Digital outputs function: NetWordOUT1 - bit 2 (Dig.out.function: NetWordOUT1.02) • For further possible settings, see parameter <a href="#">0x2634:001 (P420.01)</a> .	Assignment of a trigger to bit 2 of NetWordOUT1. Trigger = FALSE: bit set to 0. Trigger = TRUE: bit set to 1.
	<b>52 Operation enabled</b>	
0x2634:013 (P420.13)	Digital outputs function: NetWordOUT1 - bit 3 (Dig.out.function: NetWordOUT1.03) • For further possible settings, see parameter <a href="#">0x2634:001 (P420.01)</a> .	Assignment of a trigger to bit 3 of NetWordOUT1. Trigger = FALSE: bit set to 0. Trigger = TRUE: bit set to 1.
	<b>56 Error active</b>	
0x2634:014 (P420.14)	Digital outputs function: NetWordOUT1 - bit 4 (Dig.out.function: NetWordOUT1.04) • For further possible settings, see parameter <a href="#">0x2634:001 (P420.01)</a> .	Assignment of a trigger to bit 4 of NetWordOUT1. Trigger = FALSE: bit set to 0. Trigger = TRUE: bit set to 1.
	<b>0 Not connected</b>	
0x2634:015 (P420.15)	Digital outputs function: NetWordOUT1 - bit 5 (Dig.out.function: NetWordOUT1.05) • For further possible settings, see parameter <a href="#">0x2634:001 (P420.01)</a> .	Assignment of a trigger to bit 5 of NetWordOUT1. Trigger = FALSE: bit set to 0. Trigger = TRUE: bit set to 1.
	<b>54 Quick stop active</b>	

Parameter	Name / value range / [default setting]	Info
0x2634:016 (P420.16)	Digital outputs function: NetWordOUT1 - bit 6 (Dig.out.function: NetWordOUT1.06) • For further possible settings, see parameter <a href="#">0x2634:001 (P420.01)</a> .	Assignment of a trigger to bit 6 of NetWordOUT1. Trigger = FALSE: bit set to 0. Trigger = TRUE: bit set to 1.
	<b>50</b> Running	
0x2634:017 (P420.17)	Digital outputs function: NetWordOUT1 - bit 7 (Dig.out.function: NetWordOUT1.07) • For further possible settings, see parameter <a href="#">0x2634:001 (P420.01)</a> .	Assignment of a trigger to bit 7 of NetWordOUT1. Trigger = FALSE: bit set to 0. Trigger = TRUE: bit set to 1.
	<b>58</b> Device warning active	
0x2634:018 (P420.18)	Digital outputs function: NetWordOUT1 - bit 8 (Dig.out.function: NetWordOUT1.08) • For further possible settings, see parameter <a href="#">0x2634:001 (P420.01)</a> .	Assignment of a trigger to bit 8 of NetWordOUT1. Trigger = FALSE: bit set to 0. Trigger = TRUE: bit set to 1.
	<b>0</b> Not connected	
0x2634:019 (P420.19)	Digital outputs function: NetWordOUT1 - bit 9 (Dig.out.function: NetWordOUT1.09) • For further possible settings, see parameter <a href="#">0x2634:001 (P420.01)</a> .	Assignment of a trigger to bit 9 of NetWordOUT1. Trigger = FALSE: bit set to 0. Trigger = TRUE: bit set to 1.
	<b>0</b> Not connected	
0x2634:020 (P420.20)	Digital outputs function: NetWordOUT1 - bit 10 (Dig.out.function: NetWordOUT1.10) • For further possible settings, see parameter <a href="#">0x2634:001 (P420.01)</a> .	Assignment of a trigger to bit 10 of NetWordOUT1. Trigger = FALSE: bit set to 0. Trigger = TRUE: bit set to 1.
	<b>72</b> Setpoint speed reached	
0x2634:021 (P420.21)	Digital outputs function: NetWordOUT1 - bit 11 (Dig.out.function: NetWordOUT1.11) • For further possible settings, see parameter <a href="#">0x2634:001 (P420.01)</a> .	Assignment of a trigger to bit 11 of NetWordOUT1. Trigger = FALSE: bit set to 0. Trigger = TRUE: bit set to 1.
	<b>78</b> Current limit reached	
0x2634:022 (P420.22)	Digital outputs function: NetWordOUT1 - bit 12 (Dig.out.function: NetWordOUT1.12) • For further possible settings, see parameter <a href="#">0x2634:001 (P420.01)</a> .	Assignment of a trigger to bit 12 of NetWordOUT1. Trigger = FALSE: bit set to 0. Trigger = TRUE: bit set to 1.
	<b>71</b> Actual speed = 0	
0x2634:023 (P420.23)	Digital outputs function: NetWordOUT1 - bit 13 (Dig.out.function: NetWordOUT1.13) • For further possible settings, see parameter <a href="#">0x2634:001 (P420.01)</a> .	Assignment of a trigger to bit 13 of NetWordOUT1. Trigger = FALSE: bit set to 0. Trigger = TRUE: bit set to 1.
	<b>69</b> Rotational direction reversed	
0x2634:024 (P420.24)	Digital outputs function: NetWordOUT1 - bit 14 (Dig.out.function: NetWordOUT1.14) • For further possible settings, see parameter <a href="#">0x2634:001 (P420.01)</a> .	Assignment of a trigger to bit 14 of NetWordOUT1. Trigger = FALSE: bit set to 0. Trigger = TRUE: bit set to 1.
	<b>115</b> Release holding brake	
0x2634:025 (P420.25)	Digital outputs function: NetWordOUT1 - bit 15 (Dig.out.function: NetWordOUT1.15) • For further possible settings, see parameter <a href="#">0x2634:001 (P420.01)</a> .	Assignment of a trigger to bit 15 of NetWordOUT1. Trigger = FALSE: bit set to 0. Trigger = TRUE: bit set to 1.
	<b>55</b> Safe torque off (STO) active	
0x2860:001 (P201.01)	Frequency control: Default setpoint source (Std. setpoints: Freq. setp. src.)	Selection of the standard setpoint source for operating mode "MS: Velocity mode". • The selected standard setpoint source is always active in the operating mode <a href="#">0x6060 (P301.00)</a> = "MS: Velocity mode [-2]" when no setpoint change-over to another setpoint source via corresponding triggers/function is active.
	<b>1</b> Keypad	
		The setpoint is specified locally by the keypad. • Default setting <a href="#">0x2601:001 (P202.01)</a> • Use the <b>↑</b> and <b>↓</b> navigation keys to change the keypad setpoint (also during running operation).



Parameter	Name / value range / [default setting]	Info
	<b>2 Analog input 1</b>	The setpoint is defined as analog signal via the analog input 1.
	<b>3 Analog input 2</b>	The setpoint is defined as analog signal via the analog input 2.
	<b>4 HTL input</b> (from version 4.1)	The digital inputs DI3 and DI4 can be configured as HTL input to use an HTL encoder as setpoint encoder or define the setpoint as a reference frequency ("pulse train").
	<b>5 Network</b>	The setpoint is defined as process data object via the network.
	<b>11 Frequency preset 1</b>	For the setpoint selection, preset values can be parameterised and selected.
	<b>12 Frequency preset 2</b>	
	<b>13 Frequency preset 3</b>	
	<b>14 Frequency preset 4</b>	
	<b>15 Frequency preset 5</b>	
	<b>16 Frequency preset 6</b>	
	<b>17 Frequency preset 7</b>	
	<b>18 Frequency preset 8</b>	
	<b>19 Frequency preset 9</b>	
	<b>20 Frequency preset 10</b>	
	<b>21 Frequency preset 11</b>	
	<b>22 Frequency preset 12</b>	
	<b>23 Frequency preset 13</b>	
	<b>24 Frequency preset 14</b>	
	<b>25 Frequency preset 15</b>	
	<b>31 Segment preset 1</b> (from version 4.1)	For the setpoint selection, the segment presets parameterised for the "sequencer" function can be selected as well.
	<b>32 Segment preset 2</b> (from version 4.1)	
	<b>33 Segment preset 3</b> (from version 4.1)	
	<b>34 Segment preset 4</b> (from version 4.1)	
	<b>35 Segment preset 5</b> (from version 4.1)	
	<b>36 Segment preset 6</b> (from version 4.1)	
	<b>37 Segment preset 7</b> (from version 4.1)	
	<b>38 Segment preset 8</b> (from version 4.1)	
	<b>50 Motor potentiometer</b>	The setpoint is generated by the "motor potentiometer" function. This function can be used as an alternative setpoint control which is controlled via two signals: "MOP setpoint up" and "MOP setpoint down".
	<b>201 Internal value</b> (from version 5.1)	Internal values of the manufacturer.
	<b>202 Internal value</b> (from version 5.1)	
	<b>203 Internal value</b> (from version 5.1)	
	<b>204 Internal value</b> (from version 5.1)	
	<b>205 Internal value</b> (from version 5.1)	
	<b>206 Internal value</b> (from version 5.1)	

Parameter	Name / value range / [default setting]	Info
0x2860:002 (P201.02)	PID control: Default setpoint source (Stnd. setpoints: PID setp. src.)	Selection of the standard setpoint source for the reference value of the PID control. <ul style="list-style-type: none"> <li>The selected standard setpoint source is always active with an activated PID control when no setpoint change-over to another setpoint source via corresponding triggers/functions is active.</li> </ul>
	1 Keypad	The setpoint is specified locally by the keypad. <ul style="list-style-type: none"> <li>Default setting <a href="#">0x2601:002 (P202.02)</a></li> <li>Use the <b>↑</b> and <b>↓</b> navigation keys to change the keypad setpoint (also during running operation).</li> </ul>
	2 Analog input 1	The setpoint is defined as analog signal via the analog input 1.
	3 Analog input 2	The setpoint is defined as analog signal via the analog input 2.
	4 HTL input (from version 4.1)	The digital inputs DI3 and DI4 can be configured as HTL input to use an HTL encoder as setpoint encoder or define the setpoint as a reference frequency ("pulse train").
	5 Network	The setpoint is defined as process data object via the network.
	11 PID preset 1	For the setpoint selection, preset values can be parameterised and selected.
	12 PID preset 2	
	13 PID preset 3	
	14 PID preset 4	
	15 PID preset 5	
	16 PID preset 6	
	17 PID preset 7	
	18 PID preset 8	
	31 Segment preset 1 (from version 4.1)	For the setpoint selection, the segment presets parameterised for the "sequencer" function can be selected as well.
	32 Segment preset 2 (from version 4.1)	
	33 Segment preset 3 (from version 4.1)	
	34 Segment preset 4 (from version 4.1)	
	35 Segment preset 5 (from version 4.1)	
	36 Segment preset 6 (from version 4.1)	
37 Segment preset 7 (from version 4.1)		
38 Segment preset 8 (from version 4.1)		
50 Motor potentiometer	The setpoint is generated by the "motor potentiometer" function. This function can be used as an alternative setpoint control which is controlled via two signals: "MOP setpoint up" and "MOP setpoint down".	
201 Internal value (from version 5.1)	Internal values of the manufacturer.	
202 Internal value (from version 5.1)		
203 Internal value (from version 5.1)		
204 Internal value (from version 5.1)		
205 Internal value (from version 5.1)		
206 Internal value (from version 5.1)		

Parameter	Name / value range / [default setting]	Info
0x4008:001 (P590.01)	Process input words: NetWordIN1 (NetWordINx: NetWordIN1) 0x0000 ... [0x0000] ... 0xFFFF	Mappable data word for flexible control of the inverter via network.
	Bit 0 Mapping bit 0	Assignment of the function <a href="#">0x400E:001 (P505.01)</a>
	Bit 1 Mapping bit 1	Assignment of the function <a href="#">0x400E:002 (P505.02)</a>
	Bit 2 Mapping bit 2	Assignment of the function <a href="#">0x400E:003 (P505.03)</a>
	Bit 3 Mapping bit 3	Assignment of the function <a href="#">0x400E:004 (P505.04)</a>
	Bit 4 Mapping bit 4	Assignment of the function <a href="#">0x400E:005 (P505.05)</a>
	Bit 5 Mapping bit 5	Assignment of the function <a href="#">0x400E:006 (P505.06)</a>
	Bit 6 Mapping bit 6	Assignment of the function <a href="#">0x400E:007 (P505.07)</a>
	Bit 7 Mapping bit 7	Assignment of the function <a href="#">0x400E:008 (P505.08)</a>
	Bit 8 Mapping bit 8	Assignment of the function <a href="#">0x400E:009 (P505.09)</a>
	Bit 9 Mapping bit 9	Assignment of the function <a href="#">0x400E:010 (P505.10)</a>
	Bit 10 Mapping bit 10	Assignment of the function <a href="#">0x400E:011 (P505.11)</a>
	Bit 11 Mapping bit 11	Assignment of the function <a href="#">0x400E:012 (P505.12)</a>
	Bit 12 Mapping bit 12	Assignment of the function <a href="#">0x400E:013 (P505.13)</a> . Alternatively, this mapping bit can be used for controlling the digital outputs.  Assignment of the digital outputs: <ul style="list-style-type: none"> <li>Relay: <a href="#">0x2634:001 (P420.01)</a> / selection [30]</li> <li>Digital output 1: <a href="#">0x2634:002 (P420.02)</a> / selection [30]</li> </ul> <p>Note! Do not assign the mapping bit to a function and a digital output at the same time. A double assignment can cause an unpredictable drive behaviour!</p>
	Bit 13 Mapping bit 13	Assignment of the function <a href="#">0x400E:014 (P505.14)</a> . Alternatively, this mapping bit can be used for controlling the digital outputs.  Assignment of the digital outputs: <ul style="list-style-type: none"> <li>Relay: <a href="#">0x2634:001 (P420.01)</a> / selection [31]</li> <li>Digital output 1: <a href="#">0x2634:002 (P420.02)</a> / selection [31]</li> </ul> <p>Note! Do not assign the mapping bit to a function and a digital output at the same time. A double assignment can cause an unpredictable drive behaviour!</p>
	Bit 14 Mapping bit 14	Assignment of the function <a href="#">0x400E:015 (P505.15)</a> . Alternatively, this mapping bit can be used for controlling the digital outputs.  Assignment of the digital outputs: <ul style="list-style-type: none"> <li>Relay: <a href="#">0x2634:001 (P420.01)</a> / selection [32]</li> <li>Digital output 1: <a href="#">0x2634:002 (P420.02)</a> / selection [32]</li> </ul> <p>Note! Do not assign the mapping bit to a function and a digital output at the same time. A double assignment can cause an unpredictable drive behaviour!</p>
Bit 15 Mapping bit 15	Assignment of the function <a href="#">0x400E:016 (P505.16)</a> . Alternatively, this mapping bit can be used for controlling the digital outputs.  Assignment of the digital outputs: <ul style="list-style-type: none"> <li>Relay: <a href="#">0x2634:001 (P420.01)</a> / selection [33]</li> <li>Digital output 1: <a href="#">0x2634:002 (P420.02)</a> / selection [33]</li> </ul> <p>Note! Do not assign the mapping bit to a function and a digital output at the same time. A double assignment can cause an unpredictable drive behaviour!</p>	

Parameter	Name / value range / [default setting]	Info
0x400A:001 (P591.01)	Process output words: NetWordOUT1 (NetWordOUTx: NetWordOUT1) • Read only	Mappable data word for the output of status messages of the inverter via network.
	Bit 0 Mapping bit 0	Mappable data word for the output of status messages of the inverter via network. Assignment of the status message: <a href="#">0x2634:010 (P420.10)</a>
	Bit 1 Mapping bit 1	Mappable data word for the output of status messages of the inverter via network. Assignment of the status message: <a href="#">0x2634:011 (P420.11)</a>
	Bit 2 Mapping bit 2	Mappable data word for the output of status messages of the inverter via network. Assignment of the status message: <a href="#">0x2634:012 (P420.12)</a>
	Bit 3 Mapping bit 3	Mappable data word for the output of status messages of the inverter via network. Assignment of the status message: <a href="#">0x2634:013 (P420.13)</a>
	Bit 4 Mapping bit 4	Mappable data word for the output of status messages of the inverter via network. Assignment of the status message: <a href="#">0x2634:014 (P420.14)</a>
	Bit 5 Mapping bit 5	Mappable data word for the output of status messages of the inverter via network. Assignment of the status message: <a href="#">0x2634:015 (P420.15)</a>
	Bit 6 Mapping bit 6	Mappable data word for the output of status messages of the inverter via network. Assignment of the status message: <a href="#">0x2634:016 (P420.16)</a>
	Bit 7 Mapping bit 7	Mappable data word for the output of status messages of the inverter via network. Assignment of the status message: <a href="#">0x2634:017 (P420.17)</a>
	Bit 8 Mapping bit 8	Mappable data word for the output of status messages of the inverter via network. Assignment of the status message: <a href="#">0x2634:018 (P420.18)</a>
	Bit 9 Mapping bit 9	Mappable data word for the output of status messages of the inverter via network. Assignment of the status message: <a href="#">0x2634:019 (P420.19)</a>
	Bit 10 Mapping bit 10	Mappable data word for the output of status messages of the inverter via network. Assignment of the status message: <a href="#">0x2634:020 (P420.20)</a>
	Bit 11 Mapping bit 11	Mappable data word for the output of status messages of the inverter via network. Assignment of the status message: <a href="#">0x2634:021 (P420.21)</a>
	Bit 12 Mapping bit 12	Mappable data word for the output of status messages of the inverter via network. Assignment of the status message: <a href="#">0x2634:022 (P420.22)</a>
	Bit 13 Mapping bit 13	Mappable data word for the output of status messages of the inverter via network. Assignment of the status message: <a href="#">0x2634:023 (P420.23)</a>
	Bit 14 Mapping bit 14	Mappable data word for the output of status messages of the inverter via network. Assignment of the status message: <a href="#">0x2634:024 (P420.24)</a>
Bit 15 Mapping bit 15	Mappable data word for the output of status messages of the inverter via network. Assignment of the status message: <a href="#">0x2634:025 (P420.25)</a>	

Parameter	Name / value range / [default setting]	Info
0x400A:002 (P591.02)	Process output words: NetWordOUT2 (NetWordOUTx: NetWordOUT2)	Mappable data word for the output of messages of the "Sequencer" function via network.
	• Read only	Configuration of the messages:
	Bit 0 Mapping bit 0	• 0x4026:008: NetWordOUT2 value for sequencer segment 1
	Bit 1 Mapping bit 1	• 0x4027:008: NetWordOUT2 value for sequencer segment 2
	Bit 2 Mapping bit 2	• 0x4028:008: NetWordOUT2 value for sequencer segment 3
	Bit 3 Mapping bit 3	• 0x4029:008: NetWordOUT2 value for sequencer segment 4
	Bit 4 Mapping bit 4	• 0x402A:008: NetWordOUT2 value for sequencer segment 5
	Bit 5 Mapping bit 5	• 0x402B:008: NetWordOUT2 value for sequencer segment 6
	Bit 6 Mapping bit 6	• 0x402C:008: NetWordOUT2 value for sequencer segment 7
	Bit 7 Mapping bit 7	• 0x402D:008: NetWordOUT2 value for sequencer segment 8
	Bit 8 Mapping bit 8	• 0x402E:008: NetWordOUT2 value for final segment.
	Bit 9 Mapping bit 9	
	Bit 10 Mapping bit 10	
	Bit 11 Mapping bit 11	
	Bit 12 Mapping bit 12	
	Bit 13 Mapping bit 13	
Bit 14 Mapping bit 14		
Bit 15 Mapping bit 15		

## 2 Predefined process data words

Process data are exchanged via cyclic data exchange between the network master and the inverter.

### Details

For the cyclic data exchange, the inverter is provided with 24 network registers.

- 12 network registers are provided as input registers for data words from the network master to the inverter.
- 12 network registers are provided as output registers for data words from the inverter to the network master.
- Each network register is provided with a corresponding code that defines which parameters (or other data codes) are mapped to the network register.
- The input and output registers are divided into three blocks (A, B, C) in each case, featuring 4 successive data words, respectively

Network register	
Input register	Output register
Network IN A0	Network OUT A0
Network IN A1	Network OUT A1
Network IN A2	Network OUT A2
Network IN A3	Network OUT A3
Network IN B0	Network OUT B0
Network IN B1	Network OUT B1
Network IN B2	Network OUT B2
Network IN B3	Network OUT B3
Network IN C0	Network OUT C0
Network IN C1	Network OUT C1
Network IN C2	Network OUT C2
Network IN C3	Network OUT C3

The terms "input" and "output" refer to the point of view of the inverter:

- Input data are transmitted by the network master and received by the inverter.
- Output data are transmitted by the inverter and received by the network master.



The exact assignment of the network registers and the number of data words that can be transmitted cyclically varies according to the network / communication protocol. You can find some detailed information in the documentation for the respective communication protocol.

### Data mapping

For establishing a simple network connection, the inverter provides predefined control and status words for device profile CiA 402, AC drive profile as well as in LOVATO format. By means of data mapping to a network register, each of these words can be transferred as process data via network. Additionally, further mappable data words are provided to individually control the inverter. The mappable data words are described in detail in the following subchapters.



Data mapping cannot be applied to all parameters.

## 2.1 Device profile CiA 402

For control via device profile CiA 402, the parameters listed in the following can be mapped to network register.

### Details

- The mapping entry for the CiA 402 control word is 0x60400010.
- The mapping entry for the CiA 402 status word is 0x60410010.
- General information about the process of data mapping can be found in the chapter of the same name for the corresponding network.

Parameter	Name / value range / [default setting]	Info	
0x6040	CiA: Controlword 0 ... [0] ... 65535	Mappable CiA 402 control word with bit assignment according to device profile CiA 402.	
	Bit 0	Switch on 1 = switch-on	
	Bit 1	Enable voltage 1 = DC bus: Establish readiness for operation	
	Bit 2	Quick stop 0 = activate quick stop	
	Bit 3	Enable operatio 1 = enable operation	
	Bit 4	Operation mode specific	Bits are not supported.
	Bit 5	Operation mode specific	
	Bit 6	Operation mode specific	
	Bit 7	Fault reset 0-1 edge = reset error	
	Bit 8	Stop (from version 04.00) 1 = stop motor (ramping down to frequency setpoint 0 Hz)	
	Bit 9	Operation mode specific Operating mode dependent	
	Bit 14	Release holding brake 1 = releasing holding brake manually  CAUTION! • The manually triggered "Release holding brake" command has a direct impact on the "Release holding brake [115]" trigger. Thus, the holding brake can be manually released if the power section is switched off. • The responsibility for a manual release of the holding brake has the external trigger source for the "Release holding brake" command.	
0x6041 (P780.00)	CiA: Statusword (CiA: Statusword) • Read only	Mappable CiA 402 status word with bit assignment according to device profile CiA 402.	
	Bit 0	Ready to switch on 1 ≡ drive ready to start	
	Bit 1	Switched on 1 ≡ drive switched-on	
	Bit 2	Operation enabled 1 ≡ operation enabled	
	Bit 3	Fault 1 ≡ fault or trouble active	
	Bit 4	Voltage enabled 1 ≡ DC bus ready for operation	
	Bit 5	Quick stop 0 ≡ quick stop active	
	Bit 6	Switch on disabled 1 ≡ operation inhibited	
	Bit 7	Warning 1 ≡ warning active	
	Bit 8	RPDOs deactivated 1 ≡ cyclic PDOs have been deactivated	
	Bit 9	Remote 1 ≡ inverter can receive commands via network. • Bit is not set in the operating mode 0x6060 (P301.00) = "MS: Velocity mode [-2]".	
	Bit 10	Target reached 1 ≡ the actual position is in the window.	
	Bit 11	Internal limit active 1 ≡ internal limitation of a setpoint active	
	Bit 14	Holding brake released 1 ≡ holding brake released	
	Bit 15	Safe torque off (STO) not activ 0 ≡ STO active 1 ≡ STO not active	



## 2.2 AC Drive Profile

For control via AC drive profile, the parameters listed in the following can be mapped to network registers.

### Details

- The mapping entry for the AC Drive control word is 0x400B0110.
- The mapping entry for the AC Drive status word is 0x400C0110.
- Detailed information on the data mapping can be found in the chapter of the corresponding network.

### AC drive control word

The AC Drive control word [0x400B:001 \(P592.01\)](#) will only be processed if the network control in [0x2631:037 \(P400.37\)](#) has been activated and the network is also active as control source.

- Moreover, some bits in the AC drive control word are ignored if the bit 5 ("Activate network control") is not set. For details see the parameter description for [0x400B:001 \(P592.01\)](#).
- The following logic applies to bit 0 "Run forward (CW)" and bit 1 "Run reverse (CCW)":

Bit 0 "Run forward (CW)"	Bit 1 "Run reverse (CCW)"	Action
0	0	Stopping with stop method set in <a href="#">0x2838:003 (P203.03)</a> .
0↗1 (edge)	0	Run forward (CW)
0	0↗1 (edge)	Run reverse (CCW)
0↗1 (edge)	0↗1 (edge)	No action / last action is continued to be executed.
1	1	
1	0	
0	1	
1↘0 (edge)	1	Run reverse (CCW)
1	1↘0 (edge)	Run forward (CW)

For further details on the single bits, see the following parameter descriptions:

Parameter	Name / value range / [default setting]	Info
0x400B:001 (P592.01)	Process input data: AC Drive control word (Process data IN: AC control word) 0x0000 ... [0x0000] ... 0xFFFF	Mappable control word with bit assignment in compliance with EtherNet/IP™ AC drive profile.
	Bit 0 Run forward (CW)	Bits are only evaluated if bit 5 = "1".
	Bit 1 Run reverse (CCW)	For the exact logic, see the above truth table.
	Bit 2 Reset error (0-1 edge)	
	Bit 5 Activate network control	If bit 5 = "1" and <a href="#">0x2631:037 (P400.37)</a> = "Network control active[114]": All bits of the AC drive control word are evaluated. If bit 5 = "0" or <a href="#">0x2631:037 (P400.37)</a> = "Not connected [0]": • Bit 0, 1, 12, 13, 14, 15 of the AC drive control word are not evaluated (ignored). • Active control source is the "Flexible I/O configuration".
	Bit 6 Activate network setpoint	0 = the standard setpoint source selected in <a href="#">0x2860:001 (P201.01)</a> is used. 1 = network setpoint is used.
	Bit 12 Disable inverter	Bits are only evaluated if bit 5 = "1".
	Bit 13 Activate quick stop	
Bit 14 Deactivate PID controlling		
Bit 15 Activate DC braking		

Parameter	Name / value range / [default setting]	Info		
0x400C:001 (P593.01)	Process output data: AC Drive status word (Process data OUT: AC status word)	Mappable status word with bit assignment in compliance with EtherNet/IP™ AC drive profile.		
	• Read only			
	Bit 0		Fault/Trip active	
	Bit 1		Warning active	
	Bit 2		Running forward	
	Bit 3		Running reverse	
	Bit 4		Ready	
	Bit 5		Network control active	
	Bit 6		Network setpoint active	
	Bit 7		At Reference	
	Bit 8		Profile-State bit 0	The drive status is coded as follows: 0: Manufacturer-specific (reserved) 1: Startup (Drive initialisation) 2: Not_Ready (Mains voltage switched off) 3: Ready (Mains voltage switched on) 4: Enabled (Drive has received run command) 5: Stopping (Drive has received stop command and is stopped) 6: Fault_Stop (Drive is stopped due to a fault) 7: Faulted (Faults have occurred)
	Bit 9		Profile-State bit 1	
	Bit 10		Profile-State bit 2	
	Bit 11		Profile-State bit 3	
	Bit 12		Process controller active	
Bit 13	Torque mode active			
Bit 14	Current limit reached			
Bit 15	DC braking active			
0x6402	Motor type	AC motor type • Motor Data Object (0x28) - instance attribute 3		
	3		PM synchronous	
	7		<b>Squirrel cage induction</b>	

### 2.3 LOVATO profile

For connection to Lovato inverters with a control word and status word, the parameters listed in the following can be mapped to network registers.

#### Details

- The mapping entry for the control word is 0x400B0210.
- The mapping entry for the status word is 0x400C0210.
- General information about the process of data mapping can be found in the chapter of the same name for the corresponding network.

Parameter	Name / value range / [default setting]	Info	
0x400B:002 (P592.02)	Process input data: LECOM control word (Process data IN: LECOM ctrl word)	Mappable control word.	
	0x0000 ... [0x0000] ... 0xFFFF		
	Bit 0		Activate preset (bit 0)
	Bit 1		Activate preset (bit 1)
	Bit 2		Reverse rotational direction
	Bit 3		Activate quick stop
	Bit 9		Disable inverter
	Bit 10		Activate user fault
	Bit 11		Reset error (0-1 edge)
Bit 14	Activate DC braking		

Parameter	Name / value range / [default setting]	Info
0x400C:002 (P593.02)	Process output data: LECOM status word (Process data OUT: LECOM stat. word) • Read only	Mappable status word.
	Bit 0 Active parameter set (0 = set 1 or 3; 1 = set 2 or 4)	
	Bit 1 Power section inhibited	
	Bit 2 Current or Torque limit reached	
	Bit 3 Frequency setpoint reached	
	Bit 4 Ramp generator (input = output)	
	Bit 5 Frequency < frequency threshold	
	Bit 6 Actual frequency = 0	
	Bit 7 Inverter disabled	
	Bit 8 Coded status bit 0	
	Bit 9 Coded status bit 1	
	Bit 10 Coded status bit 2	
	Bit 11 Coded status bit 3	
	Bit 12 Overtemperature warning	
	Bit 13 DC-bus overvoltage	
	Bit 14 Rotational direction reversed	
Bit 15 Ready for Operation		

## 2.4 Further process data

The parameters listed in the following can also be mapped to network registers, in order to transmit control and status information as well as setpoints and actual values as process data.

### Details

- The following parameters are always available irrespective of the network option.
- The use of these parameters for the transmission of process data is optional. It is also possible to only use a part of the parameters. For the transmission of the frequency setpoint and actual value, for instance, several parameters with a different resolution can be selected.
- Via the parameters, at the same time the general network activity can be diagnosed.

### NetWordIN1 ... NetWordIN5

These mappable data words are provided to individually control the inverter:

Data word	Parameter	Intended use
NetWordIN1	0x4008:001 (P590.01)	For implementing an individual control word format.
NetWordIN2	0x4008:002 (P590.02)	For controlling the digital outputs via network.
NetWordIN3	0x4008:003 (P590.03)	For controlling the analog outputs via network.
NetWordIN4	0x4008:004 (P590.04)	
NetWordIN5	0x4008:005 (P550.05)	For defining an additive voltage impression via network.

### NetWordOUT1 and NetWordOUT2

These mappable data words are provided to output status messages to the network master:

Data word	Parameter	Intended use
NetWordOUT1	0x400A:001 (P591.01)	For implementing an individual status word format.
NetWordOUT2	0x400A:002 (P591.02)	For the output of messages of the "sequencer" function.

The following describes all further process data.

Parameter	Name / value range / [default setting]	Info
0x4008:001 (P590.01)	Process input words: NetWordIN1 (NetWordINx: NetWordIN1) 0x0000 ... [0x0000] ... 0xFFFF	Mappable data word for flexible control of the inverter via network.
	Bit 0 Mapping bit 0	Assignment of the function <a href="#">0x400E:001 (P505.01)</a>
	Bit 1 Mapping bit 1	Assignment of the function <a href="#">0x400E:002 (P505.02)</a>
	Bit 2 Mapping bit 2	Assignment of the function <a href="#">0x400E:003 (P505.03)</a>
	Bit 3 Mapping bit 3	Assignment of the function <a href="#">0x400E:004 (P505.04)</a>
	Bit 4 Mapping bit 4	Assignment of the function <a href="#">0x400E:005 (P505.05)</a>
	Bit 5 Mapping bit 5	Assignment of the function <a href="#">0x400E:006 (P505.06)</a>
	Bit 6 Mapping bit 6	Assignment of the function <a href="#">0x400E:007 (P505.07)</a>
	Bit 7 Mapping bit 7	Assignment of the function <a href="#">0x400E:008 (P505.08)</a>
	Bit 8 Mapping bit 8	Assignment of the function <a href="#">0x400E:009 (P505.09)</a>
	Bit 9 Mapping bit 9	Assignment of the function <a href="#">0x400E:010 (P505.10)</a>
	Bit 10 Mapping bit 10	Assignment of the function <a href="#">0x400E:011 (P505.11)</a>
	Bit 11 Mapping bit 11	Assignment of the function <a href="#">0x400E:012 (P505.12)</a>
	Bit 12 Mapping bit 12	Assignment of the function: <a href="#">0x400E:013 (P505.13)</a> Alternatively, this mapping bit can be used for controlling the digital outputs.  Assignment of the digital outputs: <ul style="list-style-type: none"> <li>Relay: <a href="#">0x2634:001 (P420.01)</a> / selection [30]</li> <li>Digital output 1: <a href="#">0x2634:002 (P420.02)</a> / selection [30]</li> </ul> <p>Note! Do not assign the mapping bit to a function and a digital output at the same time. A double assignment can cause an unpredictable drive behaviour!</p>
	Bit 13 Mapping bit 13	Assignment of the function: <a href="#">0x400E:014 (P505.14)</a> Alternatively, this mapping bit can be used for controlling the digital outputs.  Assignment of the digital outputs: <ul style="list-style-type: none"> <li>Relay: <a href="#">0x2634:001 (P420.01)</a> / selection [31]</li> <li>Digital output 1: <a href="#">0x2634:002 (P420.02)</a> / selection [31]</li> </ul> <p>Note! Do not assign the mapping bit to a function and a digital output at the same time. A double assignment can cause an unpredictable drive behaviour!</p>
	Bit 14 Mapping bit 14	Assignment of the function: <a href="#">0x400E:015 (P505.15)</a> Alternatively, this mapping bit can be used for controlling the digital outputs.  Assignment of the digital outputs: <ul style="list-style-type: none"> <li>Relay: <a href="#">0x2634:001 (P420.01)</a> / selection [32]</li> <li>Digital output 1: <a href="#">0x2634:002 (P420.02)</a> / selection [32]</li> </ul> <p>Note! Do not assign the mapping bit to a function and a digital output at the same time. A double assignment can cause an unpredictable drive behaviour!</p>
Bit 15 Mapping bit 15	Assignment of the function: <a href="#">0x400E:016 (P505.16)</a> Alternatively, this mapping bit can be used for controlling the digital outputs.  Assignment of the digital outputs: <ul style="list-style-type: none"> <li>Relay: <a href="#">0x2634:001 (P420.01)</a> / selection [33]</li> <li>Digital output 1: <a href="#">0x2634:002 (P420.02)</a> / selection [33]</li> </ul> <p>Note! Do not assign the mapping bit to a function and a digital output at the same time. A double assignment can cause an unpredictable drive behaviour!</p>	

Parameter	Name / value range / [default setting]	Info
0x4008:002 (P590.02)	Process input words: NetWordIN2 (NetWordINx: NetWordIN2) 0x0000 ... [0x0000] ... 0xFFFF	Mappable data word for optional control of the digital outputs via network. Assignment of the digital outputs: <ul style="list-style-type: none"> <li>Relay: <a href="#">0x2634:001 (P420.01)</a> / selection [34] ... [49]</li> <li>Digital output 1: <a href="#">0x2634:002 (P420.02)</a> / selection [34] ... [49]</li> </ul>
	Bit 0 Mapping bit 0	
	Bit 1 Mapping bit 1	
	Bit 2 Mapping bit 2	
	Bit 3 Mapping bit 3	
	Bit 4 Mapping bit 4	
	Bit 5 Mapping bit 5	
	Bit 6 Mapping bit 6	
	Bit 7 Mapping bit 7	
	Bit 8 Mapping bit 8	
	Bit 9 Mapping bit 9	
	Bit 10 Mapping bit 10	
	Bit 11 Mapping bit 11	
	Bit 12 Mapping bit 12	
	Bit 13 Mapping bit 13	
	Bit 14 Mapping bit 14	
Bit 15 Mapping bit 15		
0x4008:003 (P590.03)	Process input words: NetWordIN3 (NetWordINx: NetWordIN3) 0.0 ... [0.0] ... 100.0 %	Mappable data word for optional control of an analog output via network. Assignment of the analog output: <ul style="list-style-type: none"> <li>Analog output 1: <a href="#">0x2639:002 (P440.02)</a> = "NetWordIN3 [20]"</li> </ul>
0x4008:004 (P590.04)	Process input words: NetWordIN4 (NetWordINx: NetWordIN4) 0.0 ... [0.0] ... 100.0 %	Mappable data word for optional control of an analog output via network. Assignment of the analog output: <ul style="list-style-type: none"> <li>Analog output 1: <a href="#">0x2639:002 (P440.02)</a> = "NetWordIN4 [21]"</li> </ul>
0x4008:005 (P550.05)	Process input words: NetWordIN5 (NetWordINx: NetWordIN5) -100.0 ... [0.0] ... 100.0 %	Mappable data word for optionally specifying an additive voltage setpoint via network. <ul style="list-style-type: none"> <li>100 % ≡ Rated voltage <a href="#">0x2C01:007 (P320.07)</a></li> <li>This value is used if "Network [3]" is selected in <a href="#">0x2B13:002</a>.</li> </ul>

Parameter	Name / value range / [default setting]	Info
0x400A:001 (P591.01)	Process output words: NetWordOUT1 (NetWordOUTx: NetWordOUT1) • Read only	Mappable data word for the output of status messages of the inverter via network.
	Bit 0 Mapping bit 0	Mappable data word for the output of status messages of the inverter via network. Assignment of the status message: <a href="#">0x2634:010 (P420.10)</a>
	Bit 1 Mapping bit 1	Mappable data word for the output of status messages of the inverter via network. Assignment of the status message: <a href="#">0x2634:011 (P420.11)</a>
	Bit 2 Mapping bit 2	Mappable data word for the output of status messages of the inverter via network. Assignment of the status message: <a href="#">0x2634:012 (P420.12)</a>
	Bit 3 Mapping bit 3	Mappable data word for the output of status messages of the inverter via network. Assignment of the status message: <a href="#">0x2634:013 (P420.13)</a>
	Bit 4 Mapping bit 4	Mappable data word for the output of status messages of the inverter via network. Assignment of the status message: <a href="#">0x2634:014 (P420.14)</a>
	Bit 5 Mapping bit 5	Mappable data word for the output of status messages of the inverter via network. Assignment of the status message: <a href="#">0x2634:015 (P420.15)</a>
	Bit 6 Mapping bit 6	Mappable data word for the output of status messages of the inverter via network. Assignment of the status message: <a href="#">0x2634:016 (P420.16)</a>
	Bit 7 Mapping bit 7	Mappable data word for the output of status messages of the inverter via network. Assignment of the status message: <a href="#">0x2634:017 (P420.17)</a>
	Bit 8 Mapping bit 8	Mappable data word for the output of status messages of the inverter via network. Assignment of the status message: <a href="#">0x2634:018 (P420.18)</a>
	Bit 9 Mapping bit 9	Mappable data word for the output of status messages of the inverter via network. Assignment of the status message: <a href="#">0x2634:019 (P420.19)</a>
	Bit 10 Mapping bit 10	Mappable data word for the output of status messages of the inverter via network. Assignment of the status message: <a href="#">0x2634:020 (P420.20)</a>
	Bit 11 Mapping bit 11	Mappable data word for the output of status messages of the inverter via network. Assignment of the status message: <a href="#">0x2634:021 (P420.21)</a>
	Bit 12 Mapping bit 12	Mappable data word for the output of status messages of the inverter via network. Assignment of the status message: <a href="#">0x2634:022 (P420.22)</a>
	Bit 13 Mapping bit 13	Mappable data word for the output of status messages of the inverter via network. Assignment of the status message: <a href="#">0x2634:023 (P420.23)</a>
	Bit 14 Mapping bit 14	Mappable data word for the output of status messages of the inverter via network. Assignment of the status message: <a href="#">0x2634:024 (P420.24)</a>
Bit 15 Mapping bit 15	Mappable data word for the output of status messages of the inverter via network. Assignment of the status message: <a href="#">0x2634:025 (P420.25)</a>	



Parameter	Name / value range / [default setting]	Info
0x400A:002 (P591.02)	Process output words: NetWordOUT2 (NetWordOUTx: NetWordOUT2)	Mappable data word for the output of messages of the "Sequencer" function via network.  Configuration of the messages: <ul style="list-style-type: none"> <li>• 0x4026:008: NetWordOUT2 value for sequencer segment 1</li> <li>• 0x4027:008: NetWordOUT2 value for sequencer segment 2</li> <li>• 0x4028:008: NetWordOUT2 value for sequencer segment 3</li> <li>• 0x4029:008: NetWordOUT2 value for sequencer segment 4</li> <li>• 0x402A:008: NetWordOUT2 value for sequencer segment 5</li> <li>• 0x402B:008: NetWordOUT2 value for sequencer segment 6</li> <li>• 0x402C:008: NetWordOUT2 value for sequencer segment 7</li> <li>• 0x402D:008: NetWordOUT2 value for sequencer segment 8</li> <li>• 0x402E:008: NetWordOUT2 value for final segment.</li> </ul>
	• Read only	
	Bit 0 Mapping bit 0	
	Bit 1 Mapping bit 1	
	Bit 2 Mapping bit 2	
	Bit 3 Mapping bit 3	
	Bit 4 Mapping bit 4	
	Bit 5 Mapping bit 5	
	Bit 6 Mapping bit 6	
	Bit 7 Mapping bit 7	
	Bit 8 Mapping bit 8	
	Bit 9 Mapping bit 9	
	Bit 10 Mapping bit 10	
	Bit 11 Mapping bit 11	
	Bit 12 Mapping bit 12	
	Bit 13 Mapping bit 13	
Bit 14 Mapping bit 14		
Bit 15 Mapping bit 15		
0x400B:003 (P592.03)	Process input data: Network setpoint frequency (0.1) (Process data IN: Net.freq. 0.1) 0.0 ... [0.0] ... 599.0 Hz	Mappable parameter for specifying the frequency setpoint in [0.1 Hz] via network. <ul style="list-style-type: none"> <li>• The specification is made without sign (irrespective of the rotating direction).</li> <li>• The rotating direction is specified via the control word.</li> <li>• Example: 456 ≙ 45.6 Hz</li> </ul>
0x400B:004 (P592.04)	Process input data: Network setpoint speed (Process data IN: Net.setp. speed) 0 ... [0] ... 50000 rpm	Mappable parameter for specifying the setpoint as speed in [rpm] via network. <ul style="list-style-type: none"> <li>• The specification is made without sign (irrespective of the rotating direction).</li> <li>• The rotating direction is specified via the control word.</li> <li>• Example: 456 ≙ 456 rpm</li> </ul>
0x400B:005 (P592.05)	Process input data: Network setpoint frequency (0.01) (Process data IN: Net.freq. 0.01) 0.00 ... [0.00] ... 599.00 Hz	Mappable parameter for specifying the frequency setpoint in [0.01 Hz] via network. <ul style="list-style-type: none"> <li>• The specification is made without sign (irrespective of the rotating direction).</li> <li>• The rotating direction is specified via the control word.</li> <li>• Example: 456 ≙ 4.56 Hz</li> </ul>
0x400B:009 (P592.09)	Process input data: Torque scaling (Process data IN: Torque scaling) -128 ... [0] ... 127	Scaling factor for torque setpoint 0x400B:008 (P592.08) and actual torque value 0x400C:007 (P593.07) via network. <ul style="list-style-type: none"> <li>• With the setting 0, no scaling takes place.</li> </ul>
0x400B:012 (P592.12)	Process input data: Network setpoint frequency [0.02Hz] (Process data IN: NetSetfreq0.02Hz) -29950 ... [0] ... 29950 Hz <ul style="list-style-type: none"> <li>• From version 4.1</li> </ul>	Mappable parameter for specifying the frequency setpoint in [0.02 Hz] via network. <ul style="list-style-type: none"> <li>• The specification is made without sign (irrespective of the rotating direction).</li> <li>• The rotating direction is specified via the control word.</li> <li>• Examples: 50 ≙ 1 Hz, 100 ≙ 2 Hz</li> </ul>
0x400B:013 (P592.13)	Process input data: Network frequency setpoint [±/-16384] (Process data IN: N.FrqSet±/-16384) -32768 ... [0] ... 32767 <ul style="list-style-type: none"> <li>• From version 5.1</li> </ul>	Mappable parameter for specifying the frequency setpoint via network. <ul style="list-style-type: none"> <li>• ±16384 ≙ ±100 % Maximum frequency 0x2916 (P211.00)</li> </ul>
0x400C:003 (P593.03)	Process output data: Frequency (0.1) (Process data OUT: Frequency (0.1)) <ul style="list-style-type: none"> <li>• Read only: x.x Hz</li> </ul>	Mappable parameter for the output of the actual frequency value in [0.1 Hz] via network. <ul style="list-style-type: none"> <li>• The output is effected without sign (irrespective of the rotating direction).</li> <li>• The rotating direction is specified via the status word.</li> <li>• Example: 456 ≙ 45.6 Hz</li> </ul>

Parameter	Name / value range / [default setting]	Info
0x400C:004 (P593.04)	Process output data: Motor speed (Process data OUT: Motor speed) • Read only: x rpm	Mappable parameter for the output of the actual value as speed in [rpm] via network. • The output is effected without sign (irrespective of the rotating direction). • The rotating direction is specified via the status word. • Example: 456 ≡ 456 rpm
0x400C:005 (P593.05)	Process output data: Drive status (Process data OUT: Drive status) • Read only	Mappable status word (Modbus Legacy Register 2003).
	0 Error (non-resettable) active	
	1 Error active	
	2 Waiting for start	
	3 Identifican not executed	
	4 Inverter disabled	
	5 Stop active	
	7 Identification active	
	8 Running	
	9 Acceleration active	
	10 Deceleration active	
	11 Deceleration override active	
	12 DC braking active	
	13 Flying start active	
	14 Current limit reached	
16 Process controller idle state		
0x400C:006 (P593.06)	Process output data: Frequency (0.01) (Process data OUT: Frequency 0.01) • Read only: x.xx Hz	Mappable parameter for the output of the actual frequency value in [0.01 Hz] via network. • The output is effected without sign (irrespective of the rotating direction) • The rotating direction is specified via the status word. • Example: 456 ≡ 4.56 Hz
0x400C:007 (P593.07)	Process output data: Torque scaled (Process data OUT: Torque scaled) • Read only	Mappable parameter for the output of the actual torque value in [Nm / 2 <sup>scaling factor</sup> ] via network. • The scaling factor can be set in <a href="#">0x400B:009 (P592.09)</a> . • Actual torque value = scaled actual torque value (0x400C:007) / 2 <sup>scaling factor</sup>  Example: • Scaled actual torque value (0x400C:007) = 345 [Nm] • Scaling factor (0x400B:009) = 3 • Actual torque value = 345 [Nm] / 2 <sup>3</sup> = 43.125 [Nm]
0x400C:008 (P593.08)	Process output data: Frequency [0.02 Hz] (Process data OUT: Frequency 0.02Hz) • Read only: Hz • From version 4.1	Mappable parameter for the output of the actual frequency value in [0.02 Hz] via network. • The output is effected without sign (irrespective of the rotating direction). • The rotating direction is specified via the status word. • Examples: 50 ≡ 1 Hz, 100 ≡ 2 Hz
0x400C:009 (P593.09)	Process output data: Frequency [ +/-16384] (Process data OUT: Freq. [ +/-16384]) • Read only • From version 5.1	Mappable parameter for the output of the actual frequency value via network. • ±16384 ≡ ±100 % Maximum frequency <a href="#">0x2916 (P211.00)</a>

## 2.5 Parameter access monitoring (PAM)

The parameter access monitoring can be used as basic protection against a control loss of the inverter. Monitoring is triggered if a parameter write access to a certain index does not take place at regular intervals via the established communication connection.

### Precondition

This monitoring only works when the network control is activated.

Except for the keypad, the monitoring can be used for all communication connections for instance:

- PC/Engineering Tool <--> inverter with USB module
- PC/Engineering Tool <--> inverter with WLAN module
- Controller <--> network <--> inverter with network option.

### Details

For monitoring purposes, a non-zero value must be written into the "Keep-alive register" [0x2552:002 \(P595.02\)](#) at regular intervals. The first write access with a non-zero value activates monitoring. The intervals between the write accesses must not be higher than the time-out time set in [0x2552:003 \(P595.03\)](#). If no parameter write access takes place within the time-out time, monitoring is triggered: The response selected in [0x2552:005 \(P595.05\)](#) takes place and the action selected in [0x2552:005 \(P595.05\)](#). In addition, the status bit 1 in [0x2552:006 \(P595.06\)](#) is set to "1".

The error status can be left by a normal "error reset". Since monitoring continue to be active and the time-out time is not reset by the error reset, the inverter immediately changes again to the error status. In order to prevent this, you have the following options:

- Restore communication exchange.
- Set the monitoring response in [0x2552:004 \(P595.04\)](#) to "No response [0]" or "Warning [1]".
- Change over to local or flexible control.

Parameter	Name / value range / [default setting]	Info				
0x2552:002 (P595.02)	Parameter access monitoring: Keep alive register (PAM monitoring: Keep alive reg.) 0 ... [0] ... 65535 <ul style="list-style-type: none"> <li>• From version 4.1</li> </ul>	Register for cyclic parameter write accesses for monitoring the communication link. <ul style="list-style-type: none"> <li>• If the setting is non-zero, the monitoring is active.</li> <li>• In order that the monitoring is not tripped, a non-zero value has to be entered into this index at regular intervals. The temporal distances of the write accesses must not be higher than the time-out time set in <a href="#">0x2552:003 (P595.03)</a>.</li> </ul>				
0x2552:003 (P595.03)	Parameter access monitoring: Time-out time (PAM monitoring: Time-out time) 0.0 ... [10.0] ... 6553.5 s <ul style="list-style-type: none"> <li>• From version 4.1</li> </ul>	Maximum permitted time between two write accesses to the "keep-alive-register". In case of a time-out: <ul style="list-style-type: none"> <li>• the error response selected in <a href="#">0x2552:004 (P595.04)</a> is effected,</li> <li>• the action selected in <a href="#">0x2552:005 (P595.05)</a> is effected,</li> <li>• the status bit 1 in <a href="#">0x2552:006 (P595.06)</a> is set to "1".</li> </ul>				
0x2552:004 (P595.04)	Parameter access monitoring: Reaction (PAM monitoring: Reaction) <ul style="list-style-type: none"> <li>• From version 4.1</li> <li>• For further possible settings, see parameter <a href="#">0x2D45:001 (P310.01)</a>.</li> </ul> <table border="1"> <tr> <td>0</td> <td>No response</td> </tr> </table>	0	No response	Selection of the response to the triggering of the parameter access monitoring. Associated error code: <ul style="list-style-type: none"> <li>• 33045   0x8115 - Time-out</li> </ul>		
0	No response					
0x2552:005 (P595.05)	Parameter access monitoring: Action (PAM monitoring: Action) <ul style="list-style-type: none"> <li>• From version 4.1</li> </ul> <table border="1"> <tr> <td>0</td> <td>No action</td> </tr> <tr> <td>1</td> <td>Reserved</td> </tr> </table>	0	No action	1	Reserved	Selection of the action to be executed if the parameter access monitoring is triggered.
0	No action					
1	Reserved					

Parameter	Name / value range / [default setting]	Info
0x2552:006 (P595.06)	Parameter access monitoring: Parameter Access Monitoring-Status (PAM monitoring: PAM status)	Bit coded display of the status of parameter access monitoring.
	• Read only • From version 4.1	
	Bit 0 Monitoring activate	1 ≡ parameter access monitoring is active
	Bit 1 Timeout	1 ≡ within the time-out time set in <a href="#">0x2552:003 (P595.03)</a> , no successful parameter write access to the "keep-alive register" <a href="#">0x2552:002 (P595.02)</a> was made.
0x2552:007 (P595.07)	Parameter access monitoring: WLAN reset time-out time (PAM monitoring: WLAN reset t.out) 0 ... [0] ... 65535 s • From version 5.1	Time after which the WLAN network with the current setting of the WLAN parameters is restarted if no "keep alive" messages are received. • 0 s = function deactivated (no WLAN restart). • With a setting > 0 s and a time-out, the control units sets <a href="#">0x2440 = "Restart with current values [1]"</a> .

## 2.6 Process data handling in case of error

If the inverter receives invalid process data, the inverter uses the process data received last (valid). You can optionally set that the contents of the process data in the inverter are set to the value "0" after invalid process data has been received.



The setting in [0x24E5:001](#) is independent of the response selected in [0x2859:005](#) if invalid process data has been received!

If the application requires that the drive keeps moving with the last valid process data when receiving invalid process data, set the response "No response" or "Warning" in [0x2859:005](#). Moreover, the selection "Clear data [1]" must not be set in [0x24E5:001](#). Deleting the process data would stop the motor.

Parameter	Name / value range / [default setting]	Info
0x24E5:001	Process data handling in case of error: Procedure	Selection which process data the inverter is to use after receiving invalid process data.
	0 Keep last data	The last valid process data of the master are used.
	1 Clear data	The contents of the process data in the inverter is set to the value "0".

## 3 Acyclic data exchange

The acyclic data exchange is normally used for transmitting parameter data the transmission of which is not time-critical. Such parameter data are for example operating parameters, motor data, and diagnostic information.

### Details

- The acyclic data exchange enables access to all parameters of the inverter.
- For all communication protocols except Modbus, the parameter is addressed directly via the index and subindex.
- The parameter attribute list contains a list of all inverter parameters. This list in particular includes some information that is relevant to the reading and writing of parameters via the network.

## 4 CANopen



CANopen® is an internationally approved communication protocol which is designed for commercial and industrial automation applications. High data transfer rates in connection with efficient data formatting provide for the coordination of motion control devices in multi-axis applications.

- Detailed information on CANopen can be found on the web page of the CAN in Automation (CiA) user organisation: <http://www.can-cia.org>
- Information about the dimensioning of a CANopen network can be found in the configuration document for the inverter.
- CANopen® is a registered community trademark of the CAN in Automation e. V user organisation.

### Preconditions

- Logic unit of the inverter is provided with CANopen (type code VLBXL01).
- The DIP switches for node address, baud rate and bus terminating resistors are set correctly. See "Basic network settings".
- The network is terminated by one bus terminating resistor each at the first and last node. See "Typical topology".
- The required EDS device descriptor file for the inverters to be operated are loaded in the master.
  - Download of EDS files from [www.LovatoElectric.com](http://www.LovatoElectric.com) > Downloads > Software & upgrades > Variable speed drives > Packages for VLBXSW.

### 4.1 Introduction

- The implementation of the CANopen communication profile (CiA DS301, version 4.02) enables baud rates of 20 kbps to 1 Mbps.
- For establishing a simple network connection, the inverter provides predefined control and status words for device profile CiA 402, AC-drive profile and in LOVATO format. Additionally, further mappable data words are provided to individually control the inverter.
- The inverter control is preconfigured via a CiA 402-compliant control word.

### 4.2 Typical topology

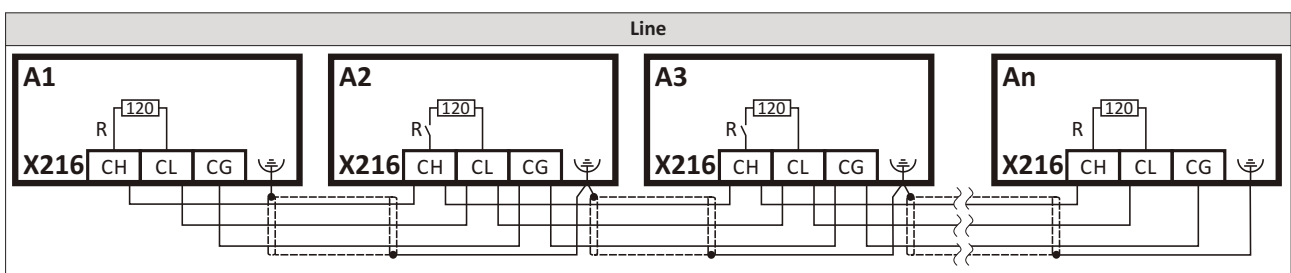

### 4.3 Node address setting

Each network node must be provided with a unique node address.

#### Details

- The node address of the inverter can be optionally set in [0x2301:001 \(P510.01\)](#) or using the DIP switches on the device labelled with "1" ... "64".
- The setting that is active when the inverter is switched on is the effective setting.
- The labelling of the DIP switches corresponds to the values of the individual DIP switches for determining the node address (see the following example).
- The active node address is displayed in [0x2302:001 \(P511.01\)](#).

#### View of the DIP switches

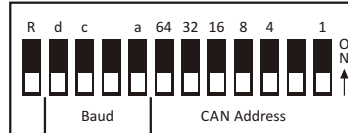

#### Example of how the node address is set via the DIP switches

DIP switch	64	32	16	8	4	2	1
Setting	OFF	OFF	ON	OFF	ON	ON	ON
Value	0	0	16	0	4	2	1
Node address	= sum of all values = 16 + 4 + 2 + 1 = <b>23</b>						

The parameters for addressing the device are described below.

Parameter	Name / value range / [default setting]	Info
0x2301:001 (P510.01)	CANopen settings: Node ID (CANopen sett.: Node ID) 1 ... [1] ... 127	Optionally setting of the node address (instead of setting via DIP switches 1 ... 64). <ul style="list-style-type: none"> <li>• The node address set here only becomes effective if DIP switches 1 ... 64 have been set to OFF before mains switching.</li> <li>• A change in the node address will not be effective until a CAN Reset Node is performed.</li> </ul>
0x2302:001 (P511.01)	Active CANopen settings: Active node ID (CANopen diag.: Active node ID) <ul style="list-style-type: none"> <li>• Read only</li> </ul>	Display of the active node address.
0x2303 (P509.00)	CANopen switch position (CANopen switch) <ul style="list-style-type: none"> <li>• Read only</li> </ul>	Display of the DIP switch setting at the last mains power-on.

#### 4.4 Baud rate setting

All network nodes must be set to the same baud rate.

##### Details

- The baud rate can be optionally set in [0x2301:002 \(P510.02\)](#) or using the DIP switches on the device labelled with "a" ... "d" (see the following table).
- The setting that is active when the inverter is switched on is the effective setting.
- The active baud rate is displayed in [0x2302:002 \(P511.02\)](#).

##### View of the DIP switches

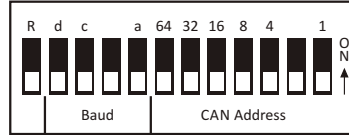

d	c	b	a	Baud rate
OFF	ON	OFF	ON	20 kbps
OFF	OFF	ON	ON	50 kbps
OFF	OFF	ON	OFF	125 kbps
OFF	OFF	OFF	ON	250 kbps
<b>OFF</b>	<b>OFF</b>	<b>OFF</b>	<b>OFF</b>	<b>500 kbps</b>
OFF	ON	OFF	OFF	1 Mbps

When a combination is set that is not in the list, the baud rate is set to 500 kbps.

The parameters for the baud rate of the device are described below.

Parameter	Name / value range / [default setting]	Info
0x2301:002 (P510.02)	CANopen settings: Baud rate (CANopen sett.: Baud rate)	Optionally setting of the baud rate (instead of setting via DIP switches a ... d). <ul style="list-style-type: none"> <li>• The parameterised baud rate is only effective if DIP switches a ... d and 1 ... 64 were set to before mains switching.</li> <li>• A change in the baud rate will not be effective until a CAN reset node is performed.</li> </ul>
	0 Automatic (from version 4.1)	
	1 20 kbps	
	2 50 kbps	
	3 125 kbps	
	4 250 kbps	
	<b>5 500 kbps</b>	
	6 800 kbps	
7 1 Mbps		
0x2302:002 (P511.02)	Active CANopen settings: Active baud rate (CANopen diag.: Active baud rate) <ul style="list-style-type: none"> <li>• Read only</li> </ul>	Display of the active baud rate.
	0 Automatic (from version 4.1)	
	1 20 kbps	
	2 50 kbps	
	3 125 kbps	
	4 250 kbps	
	5 500 kbps	
	6 800 kbps	
7 1 Mbps		

## 4.5 Configure device as mini master

If the initialisation of the CANopen network and the associated status change from "Pre-Operational" to "Operational" is not effected by a higher-level host system, the inverter can instead be defined as a "mini" master to execute this task.

### Details

The inverter is configured as mini master in [0x2301:003 \(P510.03\)](#).

- In the default setting the inverter is configured as slave and waits for the NMT telegram "Start Remote Node" from the master/host system after being switched on.
- Configured as mini master, the inverter changes to the "Operational" state after being switched on and sets all nodes connected to the CAN bus (broadcast telegram) to the "Operational" communication state using the "Start Remote Node" NMT telegram after the deceleration time set in [0x2301:004 \(P510.04\)](#) has elapsed. Only this communication status enables data exchange via the process data objects.



The change of the master/slave operation only becomes effective by renewed mains switching of the inverter or by sending the NMT telegram "Reset Node" or "Reset Communication" to the inverter. Alternatively the CAN communication can be restarted via [0x2300 \(P508.00\)](#). ▶ [Restart communication](#)

Parameter	Name / value range / [default setting]	Info
0x2301:003 (P510.03)	CANopen settings: Slave/Master (CANopen sett.: Slave/Master)	1 = after mains switching, inverter starts as mini-master.
	<b>0</b> Slave	
	1 Mini-master	
0x2301:004 (P510.04)	CANopen settings: Start remote delay (CANopen sett.: Start rem. delay) 0 ... <b>[3000]</b> ... 65535 ms	If the inverter has been defined as mini-master, a delay time can be set here, which has to elapse after mains switching before the inverter deposits the "Start Remote Node" NMT telegram on the CAN bus.



## 4.6 Diagnostics

For the purpose of diagnostics, the inverter provides several status words via which the CAN bus status, the CAN bus controller status, and the status of different time monitoring functions can be queried.

Parameter	Name / value range / [default setting]	Info
0x2307 (P515.00)	CANopen time-ou status (Time-out status) • Read only	Bit-coded status display of the CAN tim monitoring functions
	Bit 0 RPDO1-Timeout	1 ≙ RPDO1 was not received within the monitoring time or not with the sync configured. • Status is reset automatically after the RPDO has been received again. • Setting of monitoring time for RPDO1 in <a href="#">0x1400:005 (P540.05)</a> .
	Bit 1 RPDO2-Timeout	1 ≙ RPDO2 was not received within the monitoring time or not with the sync configured. • Status is reset automatically after the RPDO has been received again. • Setting of monitoring time for RPDO2 in <a href="#">0x1401:005 (P541.05)</a> .
	Bit 2 RPDO3-Timeout	1 ≙ RPDO3 was not received within the monitoring time or not with the sync configured. • Status is reset automatically after the RPDO has been received again. • Setting of monitoring time for RPDO3 in <a href="#">0x1402:005 (P542.05)</a> .
	Bit 8 Heartbeat-Timeout Consumer 1	1 ≙ within the "Heartbeat Consumer Time", no heartbeat telegram was received from node 1 to be monitored. • Status can only be reset by mains switching or error reset. • "Heartbeat Consumer Time" setting in <a href="#">0x1016:001 (P520.01)</a> .
	Bit 9 Heartbeat-Timeout Consumer 2	1 ≙ within the "Heartbeat Consumer Time", no heartbeat telegram was received from node 2 to be monitored. • Status can only be reset by mains switching or error reset. • "Heartbeat Consumer Time" setting in <a href="#">0x1016:002 (P520.02)</a> .
	Bit 10 Heartbeat-Timeout Consumer 3	1 ≙ within the "Heartbeat Consumer Time", no heartbeat telegram was received from node 3 to be monitored. • Status can only be reset by mains switching or error reset. • "Heartbeat Consumer Time" setting in <a href="#">0x1016:003 (P520.03)</a> .
	Bit 11 Heartbeat-Timeout Consumer 4	1 ≙ within the "Heartbeat Consumer Time", no heartbeat telegram was received from node 4 to be monitored. • Status can only be reset by mains switching or error reset. • "Heartbeat Consumer Time" setting in <a href="#">0x1016:004 (P520.04)</a> .
0x2308 (P516.00)	CANopen status (CANopen status) • Read only	Display of the current fieldbus state.
	0 Initialisation	Fieldbus initialisation active. • The initialisation is started automatically at mains connection. During this phase, the inverter is not involved in the data exchange process on the CAN bus. • All CAN-relevant parameters are initialised with the saved setting. • When the initialisation process has been completed, the inverter automatically adopts the "Pre-Operational" state.
	1 Reset node	"Reset Node" NMT command active. • All parameters are initialised with the saved settings (not only the CAN-relevant parameters).
	2 Reset communication	"Reset Communication" NMT command active. • Initialisation of all CAN-relevant parameters with the values stored.
	4 Stopped	Only network management telegrams can be received.
	5 Operational	Parameter data and process data can be received. If defined process data is sent as well.
	127 Pre-Operational	Parameter data can be received, process data are ignored.

Parameter	Name / value range / [default setting]	Info
0x2309 (P517.00)	CANopen controller status (CAN contr.status) • Read only	Status display of the internal CANopen controller.
	1 Error active	The inverter is a fully-fledged communication node at the CANopen network. It is able to transmit and receive data and to report faults.
	2 Error passive	The inverter can only passively indicate faulty reception via the ACK field.
	3 Bus off	The inverter is electrically separated from the CANopen network. In order to exit this state, the CANopen interface must be reset. An automatic restart is implemented.

#### 4.7 Emergency telegram

If the error status changes when an internal device error occurs or is remedied, an emergency telegram is sent to the NMT master once.

##### Details

- The identifier for the emergency telegram is fixedly defined and is shown in [0x1014](#).
- In [0x1015](#), a blocking time can be set, in order to limit the bus load in the case of emergency telegrams following quickly in succession.

Parameter	Name / value range / [default setting]	Info
0x1014	COB-ID EMCY • Read only	Display of the identifier for emergency telegrams.
0x1015	Inhibit time EMCY 0.0 ... [0.0] ... 6553.5 ms	Blocking time which can be set in order to limit the bus load in the case of emergency telegrams following quickly in succession.

#### 4.8 Heartbeat protocol

The heartbeat protocol can be used for node monitoring purposes within a CAN network.

##### Details

Basic procedure:

1. A heartbeat producer cyclically sends a heartbeat telegram to one or several receivers (consumers).
2. The consumer(s) monitor(s) the heartbeat telegram for arrival on a regular basis.

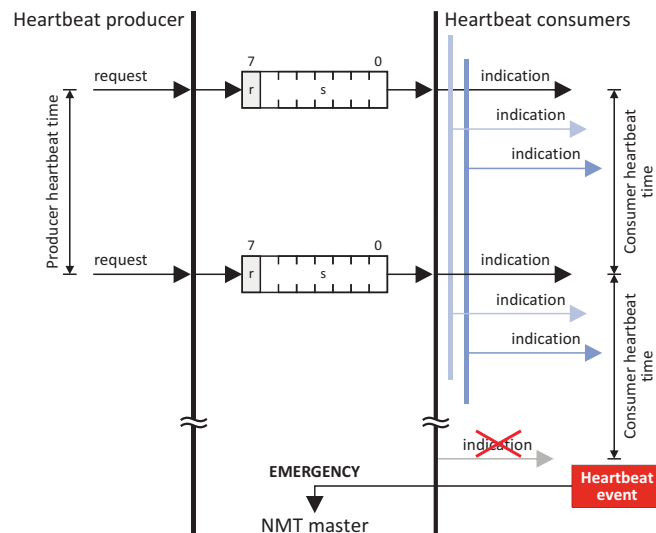

The inverter can be configured as producer or as consumer to monitor up to four other nodes.

Parameter	Name / value range / [default setting]	Info
0x1016:000 (P520.00)	Consumer heartbeat time Highest sub-index supported (Cons. heartbeat: Highest subindex) • Read only	Highest subindex, permanently set to 4. Corresponds at the same time to the maximum possible number of nodes to be monitored.

Parameter	Name / value range / [default setting]	Info
0x1016:001 (P520.01)	Consumer heartbeat time: Consumer heartbeat time 1 (Cons. heartbeat: Cons. heartbeat1) 0x00000000 ... [0x00000000] ... 0x00FFFFFF	Node ID and heartbeat time of node 1 which is to be monitored. • Format: 0x00nnhhhh (nn = node ID, hhhh = heartbeat time in [ms])
0x1016:002 (P520.02)	Consumer heartbeat time: Consumer heartbeat time 2 (Cons. heartbeat: Cons. heartbeat2) 0x00000000 ... [0x00000000] ... 0x00FFFFFF	Node ID and heartbeat time of node 2 which is to be monitored. • Format: 0x00nnhhhh (nn = node ID, hhhh = heartbeat time in [ms])
0x1016:003 (P520.03)	Consumer heartbeat time: Consumer heartbeat time 3 (Cons. heartbeat: Cons. heartbeat3) 0x00000000 ... [0x00000000] ... 0x00FFFFFF	Node ID and heartbeat time of node 3 which is to be monitored. • Format: 0x00nnhhhh (nn = node ID, hhhh = heartbeat time in [ms])
0x1016:004 (P520.04)	Consumer heartbeat time: Consumer heartbeat time 4 (Cons. heartbeat: Cons. heartbeat4) 0x00000000 ... [0x00000000] ... 0x00FFFFFF	Node ID and heartbeat time of node 4 which is to be monitored. • Format: 0x00nnhhhh (nn = node ID, hhhh = heartbeat time in [ms])
0x1017 (P522.00)	Producer heartbeat time (Prod. heartbeat) 0 ... [0] ... 65535 ms	Time interval for the transmission of the heartbeat telegram to the consumer(s). • The heartbeat telegram is sent automatically as soon as a time > 0 ms is set. • The set time is internally rounded up to the next multiple of 10 ms.

## 4.9 Process data objects

Process data objects (PDOs) are used for the cyclic transmission of (process) data via CAN-open. PDOs only contain data and an identifier. They do not contain any information about the sender or receiver and are therefore very efficient.

### Details

- Process data objects which the inverter receives via the network are referred to as "Receive PDOs" (RPDOs).
- Process data objects which the inverter sends via the network are referred to as "Transmit PDOs" (TPDOs).
- The maximum length of a PDO is 8 bytes (4 data words).
- Each PDO requires a unique identifier ("COB-ID") for the purpose of identification within the network.
- Communication parameters such as the transmission type and cycle time for each PDO can be set freely and independently of the settings of other PDOs.

### Transmission type

Process data objects can be transmitted in an event-controlled or time-controlled manner. The below table shows that it is possible to combine the different methods by means of logic operations (AND, OR):

- Event-controlled: The PDO is sent if a special device-internal event has occurred, for instance, if the data contents of the TPDO have changed or if a transmission cycle time has elapsed.
- Synchronous transmission: Transmission of a TPDOs or reception of an RPDO is effected after the inverter has received a sync telegram (COB-ID 0x80).
- Cyclic transmission: The cyclic transmission of PDOs is effected when the transmission cycle time has elapsed.
- Polled via RTR: Transmission of a TPDO is carried out on request by another device via data request frame (RTR remote transmit request). For this, the data requester (e.g. master) sends the data request frame with the COB-ID of the TPDO that is to be requested to transmit. The receiver recognises the RTR and carries out the transmission.

Transmission type	PDO transmission			Logic combination of different transmission types
	cyclic	synchronous	event-controlled	
0		●	●	AND
1 ... 240		●		-
254, 255	●		●	OR

Transmission type	Description
0	Synchronous and acyclic <ul style="list-style-type: none"> <li>• The PDO is transmitted on an event-controlled basis with every sync (e.g. when a bit change occurs in the PDO).</li> </ul>
1 ... 240	Synchronous and cyclic (sync-controlled with a response) <ul style="list-style-type: none"> <li>• Selection n = 1: The PDO is transmitted with every sync.</li> <li>• Selection 1 &lt; n ≤ 240: The PDO is transmitted with every n-th sync.</li> </ul>
241 ... 251	Reserved
252	Synchronous - RTR only
253	Asynchronous - RTR only
254, 255	Asynchronous - manufacturer-specific / device profile-specific <ul style="list-style-type: none"> <li>• If one of these values is entered, the PDO is transferred in an event-controlled or cyclic manner. (The values "254" and "255" are equivalent).</li> <li>• For a cyclic transmission, a cycle time must be entered for the respective PDO. In this case, cyclic transmission takes place in addition to event-controlled transmission.</li> </ul>

## Synchronisation of PDOs via sync telegram

During cyclic transmission, one or more PDOs are transmitted/received in fixed time intervals. An additional specific telegram, the so-called sync telegram, is used for synchronising cyclic process data.

- The sync telegram is the trigger point for the transmission of process data from the slaves to the master and for the acceptance of process data from the master in the slaves.
- For sync-controlled process data processing, the sync telegram must be generated accordingly.
- The response to a sync telegram is determined by the transmission type selected.

Generating the sync telegram:

- **0x1005** can be used to activate the generation of sync telegrams and to write the identifier value.
- Sync telegrams are created when bit 30 (see below) is set to "1".
- The interval between sync telegrams is to be set in **0x1006**.

Writing identifiers:

- To receive sync telegrams, the value 0x80 must be entered in the 11-bit identifier in the default setting (and in compliance with the CANopen specification). This means that all inverters are set to the same sync telegram by default.
- If sync telegrams are only to be received by specific nodes, their identifiers can be entered with a value of up to and including 0x07FF.
- The identifier can only be changed if the inverter does not send any sync telegrams (**0x1005**, Bit 30 = "0").

## Data telegram assignment

8th byte (data 4)		7th byte (data 3)	6th byte (data 2)	5th byte (data 1)
Bit 31	Bit 30	Bit 29 ... bit 11		Bit 10 ... bit 0
x	0/1	Extended identifier*		11-bit identifier

\*The extended identifier is not supported. Bit 11 ... bit 29 must be set to "0".

Parameter	Name / value range / [default setting]	Info																								
0x1005	COB-ID SYNC 0x00000000 ... [0x00000080] ... 0xFFFFFFFF	Identifier for sync telegram.  How to change the identifier: 1. Deactivate Sync: Set bit 30 to "0". 2. Change identifier. 3. Activate Sync: Set bit 30 to "1".																								
0x1006	Communication cyclic period 0 ... [0] ... 65535000 us	Cycle time for sync telegrams. • With the setting "0", no sync telegrams are generated. • The set time is internally rounded up to the next multiple of 10 ms. The shortest possible cycle time thus is 10 ms.																								
0x1400:000	RPDO1 communication parameter: Highest sub-index supported • Read only																									
0x1400:001 (P540.01)	RPDO1 communication parameter: COB-ID (RPDO1 config.: COB-ID) 0x00000000 ... [0x00000200] ... 0xFFFFFFFF <table border="1" style="width: 100%; border-collapse: collapse;"> <tr><td>Bit 0</td><td>COB-ID bit 0</td></tr> <tr><td>Bit 1</td><td>COB-ID bit 1</td></tr> <tr><td>Bit 2</td><td>COB-ID bit 2</td></tr> <tr><td>Bit 3</td><td>COB-ID bit 3</td></tr> <tr><td>Bit 4</td><td>COB-ID bit 4</td></tr> <tr><td>Bit 5</td><td>COB-ID bit 5</td></tr> <tr><td>Bit 6</td><td>COB-ID bit 6</td></tr> <tr><td>Bit 7</td><td>COB-ID bit 7</td></tr> <tr><td>Bit 8</td><td>COB-ID bit 8</td></tr> <tr><td>Bit 9</td><td>COB-ID bit 9</td></tr> <tr><td>Bit 10</td><td>COB-ID bit 10</td></tr> <tr><td>Bit 31</td><td>PDO invalid</td></tr> </table>	Bit 0	COB-ID bit 0	Bit 1	COB-ID bit 1	Bit 2	COB-ID bit 2	Bit 3	COB-ID bit 3	Bit 4	COB-ID bit 4	Bit 5	COB-ID bit 5	Bit 6	COB-ID bit 6	Bit 7	COB-ID bit 7	Bit 8	COB-ID bit 8	Bit 9	COB-ID bit 9	Bit 10	COB-ID bit 10	Bit 31	PDO invalid	RPDO1: identifier  How to change the identifier 1. Set PDO to "invalid": Set bit 31 to "1". 2. Change identifier and reset PDO to "valid" (bit 31 = "0").
Bit 0	COB-ID bit 0																									
Bit 1	COB-ID bit 1																									
Bit 2	COB-ID bit 2																									
Bit 3	COB-ID bit 3																									
Bit 4	COB-ID bit 4																									
Bit 5	COB-ID bit 5																									
Bit 6	COB-ID bit 6																									
Bit 7	COB-ID bit 7																									
Bit 8	COB-ID bit 8																									
Bit 9	COB-ID bit 9																									
Bit 10	COB-ID bit 10																									
Bit 31	PDO invalid																									

Parameter	Name / value range / [default setting]	Info
0x1400:002 (P540.02)	RPDO1 communication parameter: Transmission type (RPDO1 config.: Transm. type) 0 ... <b>[255]</b> ... 255	RPDO1: transmission type in compliance with DS301 V4.02
0x1400:005 (P540.05)	RPDO1 communication parameter: Event time (RPDO1 config.: Event timer) 0 ... <b>[100]</b> ... 65535 ms	RPDO1: time-ou for the monitoring of data reception
0x1401:001 (P541.01)	RPDO2 communication parameter: COB-ID (RPDO2 config.: COB-ID) 0x00000000 ... <b>[0x80000300]</b> ... 0xFFFFFFFF	RPDO2: identifier  How to change the identifier: 1. Set PDO to "invalid": Set bit 31 to "1". 2. Change identifier and reset PDO to "valid" (bit 31 = "0").
	Bit 0 COB-ID bit 0	
	Bit 1 COB-ID bit 1	
	Bit 2 COB-ID bit 2	
	Bit 3 COB-ID bit 3	
	Bit 4 COB-ID bit 4	
	Bit 5 COB-ID bit 5	
	Bit 6 COB-ID bit 6	
	Bit 7 COB-ID bit 7	
	Bit 8 COB-ID bit 8	
	Bit 9 COB-ID bit 9	
	Bit 10 COB-ID bit 10	
	Bit 31 PDO invalid	
0x1401:002 (P541.02)	RPDO2 communication parameter: Transmission type (RPDO2 config.: Transm. type) 0 ... <b>[255]</b> ... 255	RPDO2: transmission type in compliance with DS301 V4.02
0x1401:005 (P541.05)	RPDO2 communication parameter: Event time (RPDO2 config.: Event timer) 0 ... <b>[100]</b> ... 65535 ms	RPDO2: time-ou for the monitoring of data reception
0x1402:001 (P542.01)	RPDO3 communication parameter: COB-ID (RPDO3 config.: COB-ID) 0x00000000 ... <b>[0x80000400]</b> ... 0xFFFFFFFF	RPDO3: identifier  How to change the identifier: 1. Set PDO to "invalid": Set bit 31 to "1". 2. Change identifier and reset PDO to "valid" (bit 31 = "0").
	Bit 0 COB-ID bit 0	
	Bit 1 COB-ID bit 1	
	Bit 2 COB-ID bit 2	
	Bit 3 COB-ID bit 3	
	Bit 4 COB-ID bit 4	
	Bit 5 COB-ID bit 5	
	Bit 6 COB-ID bit 6	
	Bit 7 COB-ID bit 7	
	Bit 8 COB-ID bit 8	
	Bit 9 COB-ID bit 9	
	Bit 10 COB-ID bit 10	
	Bit 31 PDO invalid	
0x1402:002 (P542.02)	RPDO3 communication parameter: Transmission type (RPDO3 config.: Transm. type) 0 ... <b>[255]</b> ... 255	RPDO3: transmission type in compliance with DS301 V4.02
0x1402:005 (P542.05)	RPDO3 communication parameter: Event time (RPDO3 config.: Event timer) 0 ... <b>[100]</b> ... 65535 ms	RPDO3: time-out for the monitoring of data reception
0x1800:000	TPDO1 communication parameter: Highest sub-index supported • Read only	The value "5" is permanently set.

Parameter	Name / value range / [default setting]	Info
0x1800:001 (P550.01)	TPDO1 communication parameter: COB-ID (TPDO1 config. COB-ID) 0x00000001 ... [0x40000180] ... 0xFFFFFFFF	TPDO1: identifier  How to change the identifier: 1. Set PDO to "invalid"; Set bit 31 to "1". 2. Change identifier and reset PDO to "valid" (bit 31 = "0").
	Bit 0 COB-ID bit 0	
	Bit 1 COB-ID bit 1	
	Bit 2 COB-ID bit 2	
	Bit 3 COB-ID bit 3	
	Bit 4 COB-ID bit 4	
	Bit 5 COB-ID bit 5	
	Bit 6 COB-ID bit 6	
	Bit 7 COB-ID bit 7	
	Bit 8 COB-ID bit 8	
	Bit 9 COB-ID bit 9	
	Bit 10 COB-ID bit 10	
	Bit 30 RTR not allowed	
Bit 31 PDO invalid		
0x1800:002 (P550.02)	TPDO1 communication parameter: Transmission type (TPDO1 config.: Transm. type) 0 ... [255] ... 255	TPDO1: transmission type in compliance with DS301 V4.02
0x1800:003 (P550.03)	TPDO1 communication parameter: Inhibit time (TPDO1 config.: Inhibit time) 0.0 ... [0.0] ... 6553.5 ms	TPDO1: minimum time between the transmission of two identical PDOs (see DS301 V4.02).
0x1800:005 (P550.05)	TPDO1 communication parameter: Event time (TPDO1 config.: Event timer) 0 ... [20] ... 65535 ms	TPDO1: Cycle time for PDO transmission with transmission type "254" or "255". • The set time is internally rounded up to the next multiple of 10 ms.
0x1801:000	TPDO2 communication parameter: Highest sub-index supported • Read only	The value "5" is permanently set.
0x1801:001 (P551.01)	TPDO2 communication parameter: COB-ID (TPDO2 config. COB-ID) 0x00000001 ... [0xC0000280] ... 0xFFFFFFFF	TPDO2: identifier  How to change the identifier: 1. Set PDO to "invalid"; Set bit 31 to "1". 2. Change identifier and reset PDO to "valid" (bit 31 = "0").
	Bit 0 COB-ID bit 0	
	Bit 1 COB-ID bit 1	
	Bit 2 COB-ID bit 2	
	Bit 3 COB-ID bit 3	
	Bit 4 COB-ID bit 4	
	Bit 5 COB-ID bit 5	
	Bit 6 COB-ID bit 6	
	Bit 7 COB-ID bit 7	
	Bit 8 COB-ID bit 8	
	Bit 9 COB-ID bit 9	
	Bit 10 COB-ID bit 10	
	Bit 30 RTR not allowed	
Bit 31 PDO invalid		
0x1801:002 (P551.02)	TPDO2 communication parameter: Transmission type (TPDO2 config.: Transm. type) 0 ... [255] ... 255	TPDO2: transmission type in compliance with DS301 V4.02
0x1801:003 (P551.03)	TPDO2 communication parameter: Inhibit time (TPDO2 config.: Inhibit time) 0.0 ... [0.0] ... 6553.5 ms	TPDO2: minimum time between the transmission of two identical PDOs (see DS301 V4.02).
0x1801:005 (P551.05)	TPDO2 communication parameter: Event time (TPDO2 config.: Event timer) 0 ... [0] ... 65535 ms	TPDO2: Cycle time for PDO transmission with transmission type "254" or "255". • The set time is internally rounded up to the next multiple of 10 ms.
0x1802:000	TPDO3 communication parameter: Highest sub-index supported • Read only	The value "5" is permanently set.

Parameter	Name / value range / [default setting]	Info
0x1802:001 (P552.01)	TPDO3 communication parameter: COB-ID (TPDO3 config.: COB-ID) 0x00000001 ... [0xC0000380] ... 0xFFFFFFFF	TPDO3: identifier  How to change the identifier: 1. Set PDO to "invalid"; Set bit 31 to "1". 2. Change identifier and reset PDO to "valid" (bit 31 = "0").
	Bit 0 COB-ID bit 0	
	Bit 1 COB-ID bit 1	
	Bit 2 COB-ID bit 2	
	Bit 3 COB-ID bit 3	
	Bit 4 COB-ID bit 4	
	Bit 5 COB-ID bit 5	
	Bit 6 COB-ID bit 6	
	Bit 7 COB-ID bit 7	
	Bit 8 COB-ID bit 8	
	Bit 9 COB-ID bit 9	
	Bit 10 COB-ID bit 10	
	Bit 30 RTR not allowed	
Bit 31 PDO invalid		
0x1802:002 (P552.02)	TPDO3 communication parameter: Transmission type (TPDO3 config.: Transm. type) 0 ... [255] ... 255	TPDO3: transmission type in compliance with DS301 V4.02
0x1802:003 (P552.03)	TPDO3 communication parameter: Inhibit time (TPDO3 config.: Inhibit time) 0.0 ... [0.0] ... 6553.5 ms	TPDO3: minimum time between the transmission of two identical PDOs (see DS301 V4.02).
0x1802:005 (P552.05)	TPDO3 communication parameter: Event time (TPDO3 config.: Event timer) 0 ... [0] ... 65535 ms	TPDO3: Cycle time for PDO transmission with transmission type "254" or "255". • The set time is internally rounded up to the next multiple of 10 ms.
0x2301:006 (P510.06)	CANopen settings: COB-ID Configuration (CANopen sett.: COB-ID Config) • From version 4.1	Selection of the process for assigning the identifiers. Irrespective of this selection, these are the following bits of the identifiers: • Bit 30: "RTR not allowed" (only in case of TPDO) • Bit 31: "PDO invalid"
	<b>0</b> Base + node-ID	Identifier = set (basic) identifiers + set node address
	<b>1</b> Freely configurable	Identifier = set identifiers



## 4.10 Data mapping

Data mapping serves to define which process data are transmitted cyclically via the process data channels.

### Details

Data mapping (in the case of CANopen also referred to as "PDO mapping") is preconfigured for control of the inverter via the device profile CiA 402:

- RPDO1 = CiA 402 control word **0x6040** and Target velocity **0x6042 (P781.00)**.
- TPDO1 = CiA 402 status word **0x6041 (P780.00)** and Velocity actual value **0x6044 (P783.00)**.

### Variable PDO mapping

For individual drive solutions, the inverter supports "variable PDO mapping", providing 8 mapping entries in each case to assign 8-bit, 16-bit, and 32-bit parameters to a PDO in an optional order. The total length of the parameters mapped, however, must not exceed 8 bytes.



The process of PDO mapping cannot be applied to all parameters.

The process of variable PDO mapping only allows the following procedure:

1. Set PDO to "invalid": set bit 31 in the corresponding identifier (0x1400:1 ... 0x1402:1 or 0x1800:1 ... 0x1802:1) to "1".
2. Set PDO mapping to "invalid": Set subindex 0 in the mapping parameter (0x1600 ... 0x1602 or 0x1A00 ... 0x1A02) to "0".
3. Set desired PDO mapping via the corresponding mapping entries.  
format: 0xiiiiissll (iiii = hexadecimal index, ss = hexadecimal subindex, ll = hexadecimal data length)
4. Set subindex 0 in the mapping parameter (0x1600 ... 0x1602 or 0x1A00 ... 0x1A02) to a valid value (number of parameters mapped).
5. Reset PDO to "valid": set bit 31 in the corresponding identifier (0x1400:1 ... 0x1402:1 or 0x1800:1 ... 0x1802:1) to "0".

Parameter	Name / value range / [default setting]	Info
0x1600:000	RPDO1 mapping parameter: Number of mapped application objects in PDO 0 ... [2] ... 8	Number of objects mapped in RPDO1.
0x1600:001	RPDO1 mapping parameter: Application object 1 0x00000000 ... [0x60400010] ... 0xFFFFFFFF	Mapping entry 1 for RPDO1.
0x1600:002	RPDO1 mapping parameter: Application object 2 0x00000000 ... [0x60420010] ... 0xFFFFFFFF	Mapping entry 2 for RPDO1.
0x1600:003	RPDO1 mapping parameter: Application object 3 0x00000000 ... [0x00000000] ... 0xFFFFFFFF	Mapping entry 3 for RPDO1.
0x1600:004	RPDO1 mapping parameter: Application object 4 0x00000000 ... [0x00000000] ... 0xFFFFFFFF	Mapping entry 4 for RPDO1.
0x1600:005	RPDO1 mapping parameter: Application object 5 0x00000000 ... [0x00000000] ... 0xFFFFFFFF	Mapping entry 5 for RPDO1.
0x1600:006	RPDO1 mapping parameter: Application object 6 0x00000000 ... [0x00000000] ... 0xFFFFFFFF	Mapping entry 6 for RPDO1.
0x1600:007	RPDO1 mapping parameter: Application object 7 0x00000000 ... [0x00000000] ... 0xFFFFFFFF	Mapping entry 7 for RPDO1.
0x1600:008	RPDO1 mapping parameter: Application object 8 0x00000000 ... [0x00000000] ... 0xFFFFFFFF	Mapping entry 8 for RPDO1.
0x1601:000	RPDO2 mapping parameter: Number of mapped application objects in PDO 0 ... [0] ... 8	Number of objects mapped in RPDO2.
0x1601:001	RPDO2 mapping parameter: Application object 1 0x00000000 ... [0x00000000] ... 0xFFFFFFFF	Mapping entry 1 for RPDO2.
0x1601:002	RPDO2 mapping parameter: Application object 2 0x00000000 ... [0x00000000] ... 0xFFFFFFFF	Mapping entry 2 for RPDO2.

Parameter	Name / value range / [default setting]	Info
0x1601:003	RPDO2 mapping parameter: Application object 3 0x00000000 ... [0x00000000] ... 0xFFFFFFFF	Mapping entry 3 for RPDO2.
0x1601:004	RPDO2 mapping parameter: Application object 4 0x00000000 ... [0x00000000] ... 0xFFFFFFFF	Mapping entry 4 for RPDO2.
0x1601:005	RPDO2 mapping parameter: Application object 5 0x00000000 ... [0x00000000] ... 0xFFFFFFFF	Mapping entry 5 for RPDO2.
0x1601:006	RPDO2 mapping parameter: Application object 6 0x00000000 ... [0x00000000] ... 0xFFFFFFFF	Mapping entry 6 for RPDO2.
0x1601:007	RPDO2 mapping parameter: Application object 7 0x00000000 ... [0x00000000] ... 0xFFFFFFFF	Mapping entry 7 for RPDO2.
0x1601:008	RPDO2 mapping parameter: Application object 8 0x00000000 ... [0x00000000] ... 0xFFFFFFFF	Mapping entry 8 for RPDO2.
0x1602:000	RPDO3 mapping parameter: Number of mapped application objects in PDO 0 ... [0] ... 8	Number of objects mapped in RPDO3.
0x1602:001	RPDO3 mapping parameter: Application object 1 0x00000000 ... [0x00000000] ... 0xFFFFFFFF	Mapping entry 1 for RPDO3.
0x1602:002	RPDO3 mapping parameter: Application object 2 0x00000000 ... [0x00000000] ... 0xFFFFFFFF	Mapping entry 2 for RPDO3.
0x1602:003	RPDO3 mapping parameter: Application object 3 0x00000000 ... [0x00000000] ... 0xFFFFFFFF	Mapping entry 3 for RPDO3.
0x1602:004	RPDO3 mapping parameter: Application object 4 0x00000000 ... [0x00000000] ... 0xFFFFFFFF	Mapping entry 4 for RPDO3.
0x1602:005	RPDO3 mapping parameter: Application object 5 0x00000000 ... [0x00000000] ... 0xFFFFFFFF	Mapping entry 5 for RPDO3.
0x1602:006	RPDO3 mapping parameter: Application object 6 0x00000000 ... [0x00000000] ... 0xFFFFFFFF	Mapping entry 6 for RPDO3.
0x1602:007	RPDO3 mapping parameter: Application object 7 0x00000000 ... [0x00000000] ... 0xFFFFFFFF	Mapping entry 7 for RPDO3.
0x1602:008	RPDO3 mapping parameter: Application object 8 0x00000000 ... [0x00000000] ... 0xFFFFFFFF	Mapping entry 8 for RPDO3.
0x1A00:000	TPDO1 mapping parameter: Number of mapped application objects in TPDO 0 ... [2] ... 8	Number of objects mapped in TPDO1.
0x1A00:001	TPDO1 mapping parameter: Application object 1 0x00000000 ... [0x60410010] ... 0xFFFFFFFF	Mapping entry 1 for TPDO1.
0x1A00:002	TPDO1 mapping parameter: Application object 2 0x00000000 ... [0x60440010] ... 0xFFFFFFFF	Mapping entry 2 for TPDO1.
0x1A00:003	TPDO1 mapping parameter: Application object 3 0x00000000 ... [0x00000000] ... 0xFFFFFFFF	Mapping entry 3 for TPDO1.
0x1A00:004	TPDO1 mapping parameter: Application object 4 0x00000000 ... [0x00000000] ... 0xFFFFFFFF	Mapping entry 4 for TPDO1.
0x1A00:005	TPDO1 mapping parameter: Application object 5 0x00000000 ... [0x00000000] ... 0xFFFFFFFF	Mapping entry 5 for TPDO1.
0x1A00:006	TPDO1 mapping parameter: Application object 6 0x00000000 ... [0x00000000] ... 0xFFFFFFFF	Mapping entry 6 for TPDO1.
0x1A00:007	TPDO1 mapping parameter: Application object 7 0x00000000 ... [0x00000000] ... 0xFFFFFFFF	Mapping entry 7 for TPDO1.
0x1A00:008	TPDO1 mapping parameter: Application object 8 0x00000000 ... [0x00000000] ... 0xFFFFFFFF	Mapping entry 8 for TPDO1.
0x1A01:000	TPDO2 mapping parameter: Number of mapped application objects in TPDO 0 ... [0] ... 8	Number of objects mapped in TPDO2.
0x1A01:001	TPDO2 mapping parameter: Application object 1 0x00000000 ... [0x00000000] ... 0xFFFFFFFF	Mapping entry 1 for TPDO2.
0x1A01:002	TPDO2 mapping parameter: Application object 2 0x00000000 ... [0x00000000] ... 0xFFFFFFFF	Mapping entry 2 for TPDO2.
0x1A01:003	TPDO2 mapping parameter: Application object 3 0x00000000 ... [0x00000000] ... 0xFFFFFFFF	Mapping entry 3 for TPDO2.
0x1A01:004	TPDO2 mapping parameter: Application object 4 0x00000000 ... [0x00000000] ... 0xFFFFFFFF	Mapping entry 4 for TPDO2.

Parameter	Name / value range / [default setting]	Info
0x1A01:005	TPDO2 mapping parameter: Application object 5 0x00000000 ... [0x00000000] ... 0xFFFFFFFF	Mapping entry 5 for TPDO2.
0x1A01:006	TPDO2 mapping parameter: Application object 6 0x00000000 ... [0x00000000] ... 0xFFFFFFFF	Mapping entry 6 for TPDO2.
0x1A01:007	TPDO2 mapping parameter: Application object 7 0x00000000 ... [0x00000000] ... 0xFFFFFFFF	Mapping entry 7 for TPDO2.
0x1A01:008	TPDO2 mapping parameter: Application object 8 0x00000000 ... [0x00000000] ... 0xFFFFFFFF	Mapping entry 8 for TPDO2.
0x1A02:000	TPDO3 mapping parameter: Number of mapped application objects in TPDO 0 ... [0] ... 8	Number of objects mapped in TPDO3.
0x1A02:001	TPDO3 mapping parameter: Application object 1 0x00000000 ... [0x00000000] ... 0xFFFFFFFF	Mapping entry 1 for TPDO3.
0x1A02:002	TPDO3 mapping parameter: Application object 2 0x00000000 ... [0x00000000] ... 0xFFFFFFFF	Mapping entry 2 for TPDO3.
0x1A02:003	TPDO3 mapping parameter: Application object 3 0x00000000 ... [0x00000000] ... 0xFFFFFFFF	Mapping entry 3 for TPDO3.
0x1A02:004	TPDO3 mapping parameter: Application object 4 0x00000000 ... [0x00000000] ... 0xFFFFFFFF	Mapping entry 4 for TPDO3.
0x1A02:005	TPDO3 mapping parameter: Application object 5 0x00000000 ... [0x00000000] ... 0xFFFFFFFF	Mapping entry 5 for TPDO3.
0x1A02:006	TPDO3 mapping parameter: Application object 6 0x00000000 ... [0x00000000] ... 0xFFFFFFFF	Mapping entry 6 for TPDO3.
0x1A02:007	TPDO3 mapping parameter: Application object 7 0x00000000 ... [0x00000000] ... 0xFFFFFFFF	Mapping entry 7 for TPDO3.
0x1A02:008	TPDO3 mapping parameter: Application object 8 0x00000000 ... [0x00000000] ... 0xFFFFFFFF	Mapping entry 8 for TPDO3.

#### 4.11 Service data objects

Service data objects (SDOs) make it possible to read and write all parameters of the inverter via CANopen.

##### Details

- Two independent SDO channels are provided at the same time. SDO channel 1 is always active. SDO channel 2 can be activated via [0x2301:005 \(P510.05\)](#).
- An SDO is always transmitted with confirmation, i. e. the reception of an SDO frame is acknowledged by the receiver.
- The identifiers for SDO1 and SDO2 are generated from the basic identifier (in compliance with the "Predefined Connection Set") and the node address set:

Object	Direction		Identifier
	to the device	from the device	
SDO1	●		Basic identifier 0x600 + node address
		●	Basic identifier 0x580 + node address
SDO2	●		Basic identifier 0x640 + node address
		●	Basic identifier 0x5C0 + node address

##### Structure of the SDO frame user data

The user data are shown in Motorola format:

1st byte	2nd byte	3rd byte	4th byte	5th byte	6th byte	7th byte	8th byte
Command	Index		Subindex	Data 1	Data 2	Data 3	Data 4
See table below.	LOW byte	HIGH byte		LOW word		HIGH word	
	Address of the parameter to be read or written.			LOW byte	HIGH byte	LOW byte	HIGH byte

The following commands can be transmitted or received for writing and reading the parameters:

Command	1st byte		Data length	Info
	hex	dec		
Write request	0x23	35	4 bytes	Writing of a parameter to the inverter.
	0x2B	43	2 bytes	
	0x2F	47	1 byte	
	0x21	33	Block	
Write response	0x60	96	4 bytes	Inverter acknowledges a write request.
Read request	0x40	64	4 bytes	Reading of a parameter from the inverter.
Read response	0x43	67	4 bytes	Inverter response to a read request with the current parameter value.
	0x4B	75	2 bytes	
	0x4F	79	1 byte	
	0x41	65	Block	
Error response	0x80	128	4 bytes	Inverter response to the incorrect execution of the read/write request.

More precisely, the command byte comprises the following information:

Command	1st byte							
	Command specifier (cs)			Toggle (t)	Length*		e	s
	Bit 7	Bit 6	Bit 5	Bit 4	Bit 3	Bit 2	Bit 1	Bit 0
Write request	0	0	1	0	0/1	0/1	1	1
Write response	0	1	1	0	0	0	0	0
Read request	0	1	0	0	0	0	0	0
Read response	0	1	0	0	0/1	0/1	1	1
Error response	1	0	0	0	0	0	0	0

\*Bit coding of the length: 00 = 4 bytes, 01 = 3 bytes, 10 = 2 bytes, 11 = 1 byte  
 e: expedited (shortened block service)  
 s: segmented (normal block service)

More commands are defined in the DS301 V4.02 CANopen specification (e. g. segmented transfer).

Maximally 4 bytes are available for parameter value entries. Depending on the data format, they are assigned as follows:

5th byte	6th byte	7th byte	8th byte
Parameter value (1 byte)	0x00	0x00	0x00
Parameter value (2 bytes)		0x00	0x00
LOW byte	HIGH byte		
Parameter value (4 bytes)			
LOW word		HIGH word	
LOW byte	HIGH byte	LOW byte	HIGH byte



The parameter attribute `list` in the annex also specifies a scaling factor. The scaling factor is relevant to the transmission of parameter values which are represented with one or several decimal positions in the parameter list. If the scaling factor is  $> 1$ , before the transmission, the value must be multiplied with the scaling factor specified, so that the value can be transferred completely (as an integer value). On the SDO-client side, the integer value must then be divided by the scaling factor again, in order to receive the original value with decimal positions.

Parameter	Name / value range / [default setting]	Info
0x1200:000	SDO1 server parameter: Highest sub-index supported • Read only	
0x1200:001	SDO1 server parameter: COB-ID client -> server (rx) • Read only	Display of the receive identifier for SDO server channel 1 (basic SDO channel). • According to DS301 V4.02, the basic SDO channel can neither be changed nor deactivated
0x1200:002	SDO1 server parameter: COB-ID server -> client (tx) • Read only	Display of the transmit identifier for SDO server channel 1 (basic SDO channel). • According to DS301 V4.02, the basic SDO channel can neither be changed nor deactivated
0x1201:000	SDO2 server parameter: Highest sub-index supported • Read only	
0x1201:001	SDO2 server parameter: COB-ID client -> server (rx) 0x00000000 ... [0x80000640] ... 0xFFFFFFFF	Specification of the receive identifier for SDO server channel 2. • If SDO server channel 2 is activated via 0x2301:005 (P510.05), this parameter is set to the value "node address + 0x640". This default setting can be changed.
0x1201:002	SDO2 server parameter: COB-ID server -> client (tx) 0x00000000 ... [0x800005C0] ... 0xFFFFFFFF	Specification of the transmit identifier for SDO server channel 2. • If SDO server channel 2 is activated via 0x2301:005 (P510.05), this parameter is set to the value "node address + 0x5C0". This default setting can be changed.
0x1201:003	SDO2 server parameter: Node-ID of the SDO client 1 ... [0] ... 127	Specification of the node address for the SDO client.
0x2301:005 (P510.05)	CANopen settings: Activate SDO2 channel (CANopen sett.: SDO2 channel)	1 = activate SDO server channel 2.
	0 Not active	
	1 Active	

#### 4.12 Error responses

The response to CANopen errors such as missing PDOs or heartbeat frames can be configured via the following parameters.

Parameter	Name / value range / [default setting]	Info
0x1029:000	Error behavior: Highest sub-index supported • Read only	

Parameter	Name / value range / [default setting]	Info
0x1029:001	Error behavior: Communication error	Selection of the NMT state to which the inverter is to change automatically if a failure of a CANopen node or an internal error is detected in the "Operational" state.  These also include the following communication errors: <ul style="list-style-type: none"> <li>• Change-over of the CAN interface to the "Bus-off" state.</li> <li>• Occurrence of a "Heartbeat Event".</li> </ul>
	<b>0</b> Status -> Pre-operationa	In the "Pre-operational" state, network management, sync, and emergency telegrams as well as parameter data can be received; process data, however, are ignored.
	<b>1</b> No status change	
	<b>2</b> Status -> Stopped	In the "Stopped" state, only network management telegrams can be received.
0x2857:001	CANopen monitoring: RPDO1-Timeout <ul style="list-style-type: none"> <li>• For further possible settings, see parameter <a href="#">0x2D45:001 (P310.01)</a>.</li> </ul>	Selection of the response to triggering the RPDO1 time monitoring.  Associated error code: <ul style="list-style-type: none"> <li>• <a href="#">33425</a>   <a href="#">0x8291</a> - CAN: RPDO1 time-out</li> </ul>
	<b>3</b> Fault	
0x2857:002	CANopen monitoring: RPDO2-Timeout <ul style="list-style-type: none"> <li>• For further possible settings, see parameter <a href="#">0x2D45:001 (P310.01)</a>.</li> </ul>	Selection of the response to triggering the RPDO2 time monitoring.  Associated error code: <ul style="list-style-type: none"> <li>• <a href="#">33426</a>   <a href="#">0x8292</a> - CAN: RPDO2 time-out</li> </ul>
	<b>3</b> Fault	
0x2857:003	CANopen monitoring: RPDO3-Timeout <ul style="list-style-type: none"> <li>• For further possible settings, see parameter <a href="#">0x2D45:001 (P310.01)</a>.</li> </ul>	Selection of the response to triggering the RPDO3 time monitoring.  Associated error code: <ul style="list-style-type: none"> <li>• <a href="#">33427</a>   <a href="#">0x8293</a> - CAN: RPDO3 time-out</li> </ul>
	<b>3</b> Fault	
0x2857:005	CANopen monitoring: Heartbeat-Timeout Consumer 1 <ul style="list-style-type: none"> <li>• For further possible settings, see parameter <a href="#">0x2D45:001 (P310.01)</a>.</li> </ul>	Selection of the response with "Heartbeat Event" in consumer 1.  Associated error code: <ul style="list-style-type: none"> <li>• <a href="#">33156</a>   <a href="#">0x8184</a> - CAN: heartbeat time-out consumer 1</li> </ul>
	<b>3</b> Fault	
0x2857:006	CANopen monitoring: Heartbeat-Timeout Consumer 2 <ul style="list-style-type: none"> <li>• For further possible settings, see parameter <a href="#">0x2D45:001 (P310.01)</a>.</li> </ul>	Selection of the response with "Heartbeat Event" in consumer 2.  Associated error code: <ul style="list-style-type: none"> <li>• <a href="#">33157</a>   <a href="#">0x8185</a> - CAN: heartbeat time-out consumer 2</li> </ul>
	<b>3</b> Fault	
0x2857:007	CANopen monitoring: Heartbeat-Timeout Consumer 3 <ul style="list-style-type: none"> <li>• For further possible settings, see parameter <a href="#">0x2D45:001 (P310.01)</a>.</li> </ul>	Selection of the response with "Heartbeat Event" in consumer 3.  Associated error code: <ul style="list-style-type: none"> <li>• <a href="#">33158</a>   <a href="#">0x8186</a> - CAN: heartbeat time-out consumer 3</li> </ul>
	<b>3</b> Fault	
0x2857:008	CANopen monitoring: Heartbeat-Timeout Consumer 4 <ul style="list-style-type: none"> <li>• For further possible settings, see parameter <a href="#">0x2D45:001 (P310.01)</a>.</li> </ul>	Selection of the response with "Heartbeat Event" in consumer 4.  Associated error code: <ul style="list-style-type: none"> <li>• <a href="#">33159</a>   <a href="#">0x8187</a> - CAN: heartbeat time-out consumer 4</li> </ul>
	<b>3</b> Fault	
0x2857:010	CANopen monitoring: "Bus-off" state change <ul style="list-style-type: none"> <li>• For further possible settings, see parameter <a href="#">0x2D45:001 (P310.01)</a>.</li> </ul>	Selection of the response to changing to the "Bus off" state.  Associated error code: <ul style="list-style-type: none"> <li>• <a href="#">33154</a>   <a href="#">0x8182</a> - CAN: bus off</li> </ul>
	<b>2</b> Trouble	
0x2857:011	CANopen monitoring: Warning <ul style="list-style-type: none"> <li>• For further possible settings, see parameter <a href="#">0x2D45:001 (P310.01)</a>.</li> </ul>	Selection of the response that is executed in the case of too many incorrectly sent or received CAN telegrams (> 96).  Associated error code: <ul style="list-style-type: none"> <li>• <a href="#">33155</a>   <a href="#">0x8183</a> - CAN: warning</li> </ul>
	<b>1</b> Warning	

#### 4.13 Diagnostic counter

The following parameters serve to diagnose the communication activities between the inverter and the CANopen network. The counters are free-running, i. e. when the maximum value has been reached, the respective counter starts at 0 again.

Parameter	Name / value range / [default setting]	Info
0x230A:000	CANopen statistics: Highest subindex <ul style="list-style-type: none"> <li>• Read only</li> </ul>	Number of frame and error counters.
0x230A:001 (P580.01)	CANopen statistics: PDO1 received (CAN statistics: PDO1 received) <ul style="list-style-type: none"> <li>• Read only</li> </ul>	Display of the number of PDO1 telegrams received.



Parameter	Name / value range / [default setting]	Info
0x230A:002 (P580.02)	CANopen statistics: PDO2 received (CAN statistics: PDO2 received) • Read only	Display of the number of PDO2 telegrams received.
0x230A:003 (P580.03)	CANopen statistics: PDO3 received (CAN statistics: PDO3 received) • Read only	Display of the number of PDO3 telegrams received.
0x230A:005 (P580.05)	CANopen statistics: PDO1 transmitted (CAN statistics: PDO1 transmitted) • Read only	Display of the number of PDO1 telegrams sent.
0x230A:006 (P580.06)	CANopen statistics: PDO2 transmitted (CAN statistics: PDO2 transmitted) • Read only	Display of the number of PDO2 telegrams sent.
0x230A:007 (P580.07)	CANopen statistics: PDO3 transmitted (CAN statistics: PDO3 transmitted) • Read only	Display of the number of PDO3 telegrams sent.
0x230A:009 (P580.09)	CANopen statistics: SDO1 telegrams (CAN statistics: SDO1 counter) • Read only	Display of the number of SDO1 telegrams.
0x230A:010 (P580.10)	CANopen statistics: SDO2 telegrams (CAN statistics: SDO2 counter) • Read only	Display of the number of SDO2 telegrams.
0x230B (P518.00)	CANopen error counter (CAN errorcounter) • Read only	Display of the total number of CAN faults that have occurred.

#### 4.14 LED status displays

Information about the CAN bus status can be obtained quickly via the "CAN-RUN" and "CAN-ERR" LED displays on the front of the inverter.



The meaning can be seen from the tables below.

##### Inverter not active on the CAN bus (yet)



LED "CAN-RUN"	LED "CAN-ERR"	Meaning
off	off	Inverter is not active on the CAN bus.
		"Bus Off" state.
 Both LEDs are flickering alternately		Automatic baud rate detection active.

##### Inverter active on the CAN bus

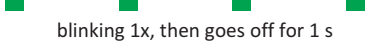
The green "CAN-RUN" LED indicates the CANopen state:

LED "CAN-RUN"	CANopen state
 blinking fast (5 Hz)	Pre-Operational
 on	Operational
 blinking 1x, then goes off for 1 s	Stopped

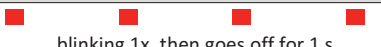
The red "CAN-ERR" LED indicates a CANopen error:

LED "CAN-ERR"	CANopen error
 blinking 1x, then goes off for 1 s	Warning Limit reached
 blinking 2x, then goes off for 1 s	Heartbeat Event
 blinking 3x, then goes off for 1 s	Sync message error (only possible in the "Operational" state)

#### 4.15 Restart communication

The following parameter can be used to restart or stop communication. Optionally it is also possible to reset all communication parameters to the default status.

##### Details

A restart of communication is required after changes of the interface configuration (e. g. node address and baud rate) in order that the changed settings become effective.

For restarting communication, there are two options:

- a) Switch inverter off and on again.
- b) Set the selection = "Restart with current values [1]" in **0x2300 (P508.00)**.

Parameter	Name / value range / [default setting]	Info
0x2300 (P508.00)	CANopen communication (CANopen comm.)	Restart / stop communication
	• Setting can only be changed if the inverter is inhibited.	• After successful execution, the value 0 is shown.
	<b>0</b> No action/no error	Only status feedback
	<b>1</b> Restart with current values	Restart communication with the current values.
	<b>2</b> Restart with default values	Restart communication with the standard values of the CAN parameters (0x1000 ... 0x1FFF and 0x2301).
	<b>5</b> Stop network communication	Stop communication
		• The "Stop Remote Node" NMT command is executed. After successful execution of this command, only the reception of network management frames is possible.
	<b>10</b> In progress	Only status feedback
<b>11</b> Action cancelled		
<b>12</b> Error		



## 4.16 Short setup

In the following, the steps required for controlling the inverter via CANopen are described.

### Parameterisation required

1. Set the CANopen node address.
  - Each network node must be provided with a unique node address.
  - Details: [▶ Node address setting](#)
2. Set the CANopen baud rate.
  - Default setting: 500 kbps
  - Details: [▶ Baud rate setting](#)
3. Optional: Configure inverter as "mini master".
  - Required if the initialisation of the CANopen network and the associated status change from "Pre-Operational" to "Operational" is not effected by a higher-level host system.
  - Details: [▶ Configure device as mini master](#)
4. Optional: Change the response of the inverter to the triggering of the RPDO time monitoring.
  - Default setting: In case of missing RPDOs, an error is triggered.
  - Details: [▶ Error responses](#)
5. Save parameter settings: `0x2022:003 (P700.03) = "On / start [1]"`.
6. Switch the inverter off and then on again in order that the changed communication settings can get effective.
7. Program the master so that the following SDO messages are sent to the inverter:
  1. `0x2631:037 (P400.37) = 1` (activate network control)
  2. `0x2860:001 (P201.01) = 5` (set network as standard setpoint source)
  3. PDO mapping and configuration of the process data objects RPDO1 and TPDO1 (see the sections "[RPDO1 mapping](#)" and "[TPDO1 mapping](#)").
8. Control inverter via RPDO1 (and evaluate the current status via TPDO1).
  - For assignment of the control word and setpoint selection, see section "[RPDO1 mapping](#)".
  - For assignment of the status word and actual value output, see section "[TPDO1 mapping](#)".
  - Acceleration `0x2917 (P220.00)` and deceleration `0x2918 (P221.00)` can be set/changed via SDO messages.



In the default setting, the digital input DI1 is assigned with the "Run" function. If the network control is activated, this function serves as "start enable" for start commands via network. Hence, the digital input DI1 must be set to HIGH level in order that the motor can be started via network.

## RPDO1 mapping

The RPDO1 is used to control the inverter.

Changing the identifier (COB-ID) and the PDO mapping only allows the following procedure:

1. Set RPDO1 to "invalid": Set bit 31 in the identifier [0x1400:001 \(P540.01\)](#) to "1".
2. Set RPDO1 mapping to "invalid": [0x1600:000](#) = set 0.
3. Map NetWordIN1 data word [0x4008:001 \(P590.01\)](#) to RPDO1:  
[0x1600:001](#) = set 0x40080110.
4. Map Network setpoint frequency (0.1) [0x400B:003 \(P592.03\)](#) to RPDO1:  
[0x1600:002](#) = set 0x400B0310.
5. Set RPDO1 mapping to "valid" again: [0x1600:000](#) = set 2 (number of mapped parameters).
6. Optional: Set time-out time for monitoring the data reception in [0x1400:005 \(P540.05\)](#) in [ms].
  - Default setting: 100 ms
7. Change identifier for RPDO1 (optional) and set RPDO1 to "valid" again: Write the new identifier into [0x1400:001 \(P540.01\)](#) and simultaneously set bit 31 to "0".
  - Default setting: 0x200 + node address (hex)
  - Example: Node address = 10 (0xA) and basic identifier = default setting:  
Identifier to be written into [0x1400:001 \(P540.01\)](#) = 0x200 + 0xA = 0x20A  
(0b0011 0000 1010)

### Function assignment of the NetWordIN1 data word (byte 1+2 of the RPDO1)

Bit	Default setting	For details and configuration, see
0	Not active (reserve)	<a href="#">0x400E:001 (P505.01)</a>
1	Not active (reserve)	<a href="#">0x400E:002 (P505.02)</a>
2	Activate quick stop	<a href="#">0x400E:003 (P505.03)</a>
3	Not active (reserve)	<a href="#">0x400E:004 (P505.04)</a>
4	Run forward (CW)	<a href="#">0x400E:005 (P505.05)</a>
5	Activate preset (bit 0)	<a href="#">0x400E:006 (P505.06)</a>
6	Activate preset (bit 1)	<a href="#">0x400E:007 (P505.07)</a>
7	Reset error	<a href="#">0x400E:008 (P505.08)</a>
8	Not active (reserve)	<a href="#">0x400E:009 (P505.09)</a>
9	Activate DC braking	<a href="#">0x400E:010 (P505.10)</a>
10	Not active (reserve)	<a href="#">0x400E:011 (P505.11)</a>
11	Not active (reserve)	<a href="#">0x400E:012 (P505.12)</a>
12	Reverse rotational direction	<a href="#">0x400E:013 (P505.13)</a>
13	Not active (reserve)	<a href="#">0x400E:014 (P505.14)</a>
14	Not active (reserve)	<a href="#">0x400E:015 (P505.15)</a>
15	Not active (reserve)	<a href="#">0x400E:016 (P505.16)</a>

Specifying the frequency setpoint (byte 3+4 of the RPDO1)

- The specification is made unsigned (independent of the direction of rotation) as integer in the resolution [0.1 Hz].
- The direction of rotation is defined in the default setting via bit 12 of the NetWordIN1 data word.
- Example: 456  $\equiv$  45.6 Hz

## TPDO1 mapping

The TPDO1 is used for the output of status information and the actual frequency value.

Changing the identifier (COB-ID) and the PDO mapping only allows the following procedure:

1. Set TPDO1 to "invalid": Set bit 31 in the identifier [0x1800:001 \(P550.01\)](#) to "1".
2. Set TPDO1 mapping to "invalid": [0x1A00:000](#) = set 0.
3. Map NetWordOUT1 data word [0x400A:001 \(P591.01\)](#) to TPDO1:  
[0x1A00:001](#) = set 0x400A0110.
4. MapFrequency (0.1) [0x400B:003 \(P592.03\)](#) to TPDO1:  
[0x1A00:002](#) = set 0x400C0310.
5. Set TPDO1 mapping to "valid" again: [0x1A00:000](#) = set 2 (number of mapped parameters).
6. Optional: Set Transmission type in [0x1800:002 \(P550.02\)](#) and Event timer in [0x1800:005 \(P550.05\)](#).
  - Default setting: Cyclic transmission every 20 ms.
7. Change identifier for TPDO1 (optional) and set TPDO1 to "valid" again: Write the new identifier into [0x1800:001 \(P550.01\)](#) and simultaneously set bit 31 to "0".
  - Default setting: 0x40000180 + node address (hex)
  - Example: Node address = 10 (0xA) and TPDO1 basic identifier = default setting:  
Identifier to be written into [0x1800:001 \(P550.01\)](#) = 0x40000180 + 0xA = 0x4000018A (0b0100 0000 0000 0000 0000 0001 1000 1010)

### Status assignment of the NetWordOUT1 data word (byte 1+2 of the TPDO1)

Bit	Default setting	For details and configuration, see
0	Ready for operation	<a href="#">0x2634:010 (P420.10)</a>
1	Not connected	<a href="#">0x2634:011 (P420.11)</a>
2	Operation enabled	<a href="#">0x2634:012 (P420.12)</a>
3	Error active	<a href="#">0x2634:013 (P420.13)</a>
4	Not connected	<a href="#">0x2634:014 (P420.14)</a>
5	Quick stop active	<a href="#">0x2634:015 (P420.15)</a>
6	Running	<a href="#">0x2634:016 (P420.16)</a>
7	Device warning active	<a href="#">0x2634:017 (P420.17)</a>
8	Not connected	<a href="#">0x2634:018 (P420.18)</a>
9	Not connected	<a href="#">0x2634:019 (P420.19)</a>
10	Setpoint speed reached	<a href="#">0x2634:020 (P420.20)</a>
11	Current limit reached	<a href="#">0x2634:021 (P420.21)</a>
12	Actual speed = 0	<a href="#">0x2634:022 (P420.22)</a>
13	Rotational direction reversed	<a href="#">0x2634:023 (P420.23)</a>
14	Release holding brake	<a href="#">0x2634:024 (P420.24)</a>
15	Safe torque off (STO) active	<a href="#">0x2634:025 (P420.25)</a>

### Output of the actual frequency value (byte 3+4 of the TPDO1)

- The output is made unsigned (independent of the direction of rotation) as integer in the resolution [0.1 Hz].
- An active reversal is displayed via bit 13 of the NetWordOUT1 data word.
- Example: 456  $\equiv$  45.6 Hz

## 5 Modbus RTU



Modbus is an internationally approved, asynchronous, serial communication protocol, designed for commercial and industrial automation applications

- Detailed information on the Modbus can be found on the web page of the international Modbus Organization, USA, who also further develop the Modbus protocol: <http://www.modbus.org>
- Information about the dimensioning of a Modbus network can be found in the configuration document for the inverter.

### Preconditions

Logic unit of the inverter is provided with Modbus (type code VLBXL06).

### 5.1 Introduction

- The process of data transmission distinguishes between three different operating modes: Modbus ASCII, Modbus RTU, and Modbus TCP. This chapter describes the Modbus RTU operating mode ("Remote Terminal Unit").
- The Modbus protocol is based on a master/slave architecture where the inverter always works as slave.
- The Modbus network only permits one master sending commands and requests. The master is also the sole instance to be allowed to initiate Modbus communication. No direct communication takes place between the slaves.
- The physical interface corresponds to TIA/EIA-485-A which is very common and suitable for the industrial environment. This interface enables baud rates from 2400 to 115200 kbps.
- The inverter supports Modbus function codes 3, 6, 16 (0x10) and 23 (0x17).

### 5.2 Typical topology

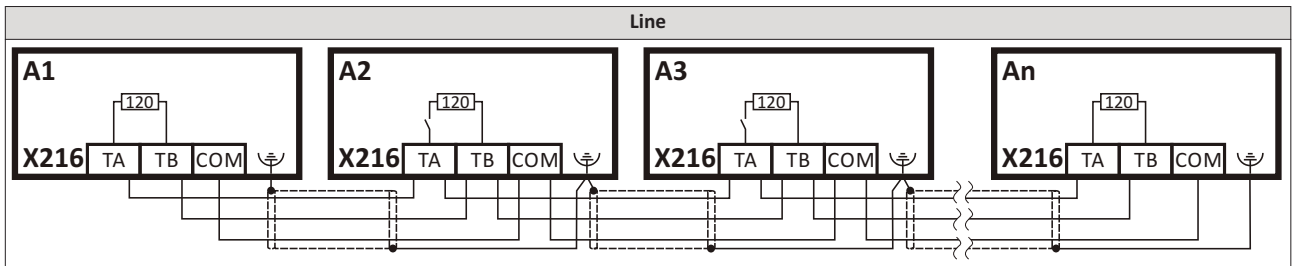

### 5.3 Node address setting

Each network node must be provided with a unique node address.

The parameters for the baud rate of the device are described below.

The parameters for addressing the device are described below.

#### Details

- The node address of the inverter can be optionally set in [0x2321:001 \(P510.01\)](#) or using the DIP switches on the device labelled with "1" ... "128".
- The setting that is active when the inverter is switched on is the effective setting.
- The labelling of the DIP switches corresponds to the values of the individual DIP switches for determining the node address (see the following example).
- The node address 0 is reserved for messages to all nodes ("Broadcast").
- The active node address is shown in [0x2322:001 \(P511.01\)](#).

#### Example of how the node address is set via the DIP switches

DIP switch	128	64	32	16	8	4	2	1
Setti	OFF	OFF	OFF	ON	OFF	ON	ON	ON
Value	0	0	0	16	0	4	2	1
Node address	= sum of all values = 16 + 4 + 2 + 1 = 23							

Parameter	Name / value range / [default setting]	Info
0x2321:001 (P510.01)	Modbus settings: Node ID (Modbus sett. Node ID) 1 ... [1] ... 247	Optionally setting of the node address (instead of setting via DIP switches 1 ... 128). <ul style="list-style-type: none"> <li>The node address set here only becomes effective if DIP switches 1 ... 128 have been set to OFF before mains switching.</li> <li>A change in the node address only becomes effective after a restart of Modbus communication</li> </ul>
Parameter	Name / value range / [default setting]	Info
0x2323 (P509.00)	Modbus switch position (Modbus switch) <ul style="list-style-type: none"> <li>Read only</li> </ul>	Display of the DIP switch setting at the last mains power-on. <ul style="list-style-type: none"> <li>The value displayed corresponds to the sum of all DIP switch values (except for DIP switches for terminating resistor).</li> </ul>

#### 5.4 Baud rate settings

All network nodes must be set to the same baud rate.

##### Details

- If the DIP switch labelled with "b" is in the OFF position at switch-on, the automatic baud rate detection function is active. If it is in the ON position, the setting in [0x2321:002 \(P510.02\)](#) applies instead.
- If the automatic baud rate detection function is activated, the first 5 ... 10 messages are lost after switch-on.
- The active baud rate is displayed in [0x2322:002 \(P511.02\)](#).

Parameter	Name / value range / [default setting]	Info
0x2321:002 (P510.02)	Modbus settings: Baud rate (Modbus sett. Baud rate)	Optionally setting of the baud rate (instead of setting via DIP switch b). <ul style="list-style-type: none"> <li>The baud rate set here is only effective if DIP switch b was set to ON before mains switching. Otherwise automatic baud rate detection is active.</li> <li>A change in the baud rate only becomes effective after a restart of Modbus communication.</li> <li>If the automatic baud rate detection function is activated, the first 5 ... 10 messages are lost after switch-on.</li> </ul>
	<b>0 Automatic</b>	
	1 2400 bps	
	2 4800 bps	
	3 9600 bps	
	4 19200 bps	
	5 38400 bps	
	6 57600 bps	
7 115200 bps		
0x2323 (P509.00)	Modbus switch position (Modbus switch) <ul style="list-style-type: none"> <li>Read only</li> </ul>	Display of the DIP switch setting at the last mains power-on. <ul style="list-style-type: none"> <li>The value displayed corresponds to the sum of all DIP switch values (except for DIP switches for terminating resistor).</li> </ul>

#### 5.5 Data format settings

All network nodes must be set to the same data format.

##### Details

- If the DIP switch labelled with "a" is in the OFF position at switch-on, the automatic data format detection function is active. If it is in the ON position, the setting in [0x2321:003 \(P510.03\)](#) applies instead.
- If the automatic data format detection function is activated, the first 5 ... 10 messages are lost after switch-on.
- The active data format is displayed in [0x2322:003 \(P511.03\)](#).

Parameter	Name / value range / [default setting]	Info
0x2321:003 (P510.03)	Modbus settings: Data format (Modbus sett. Data format)	Definition of the parity and stop bits.
	<b>0 Automatic</b>	Automatic data format detection <ul style="list-style-type: none"> <li>With this setting the first 5 ... 10 messages are lost after switch-on.</li> </ul>
	1 8, E, 1	8 data bits, even parity, 1 stop bit
	2 8, O, 1	8 data bits, odd parity, 1 stop bit
	3 8, N, 2	8 data bits, no parity bit, 2 stop bits
	4 8, N, 1	8 data bits, no parity bit, 1 stop bit
0x2323 (P509.00)	Modbus switch position (Modbus switch) <ul style="list-style-type: none"> <li>Read only</li> </ul>	Display of the DIP switch setting at the last mains power-on. <ul style="list-style-type: none"> <li>The value displayed corresponds to the sum of all DIP switch values (except for DIP switches for terminating resistor).</li> </ul>

## 5.6 Time-out monitoring

The response to the missing Modbus messages can be configured via the following parameters.

Parameter	Name / value range / [default setting]	Info
0x2858:001 (P515.01)	Modbus monitoring: Response to time-out (Modbus monit.: Resp. Time-out) <ul style="list-style-type: none"> <li>For further possible setting see parameter <a href="#">0x2D45:001 (P310.01)</a>.</li> </ul>	Selection of the response executed if no valid messages have been received via the Modbus for a longer time than the time-out period set in <a href="#">0x2858:002 (P515.02)</a> .
	<b>3</b> <b>Fault</b>	Associated error code: <ul style="list-style-type: none"> <li><a href="#">33185</a>   <a href="#">0x81A1</a> - Modbus: network time-out</li> </ul>
0x2858:002 (P515.02)	Modbus monitoring: Time-out time (Modbus monit.: Time-out time) 0.0 ... <b>[2.0]</b> ... 300.0 s	Time-out period for monitoring the message reception via Modbus.

## 5.7 Diagnostics

The following parameters serve to diagnose the communication activities between the inverter and the Modbus network.

Parameter	Name / value range / [default setting]	Info
0x2322:001 (P511.01)	Active Modbus setting: Active node ID (Modbus diag.: Activ node ID) <ul style="list-style-type: none"> <li>Read only</li> </ul>	Display of the active node address.
0x2322:002 (P511.02)	Active Modbus setting: Active baud rate (Modbus diag.: Activ baud rate) <ul style="list-style-type: none"> <li>Read only</li> <li>For the meaning of the display see parameter <a href="#">0x2321:002 (P510.02)</a>.</li> </ul>	Display of the active baud rate.
0x2322:003 (P511.03)	Activ Modbus setting Data format (Modbus diag.: Data format) <ul style="list-style-type: none"> <li>Read only</li> <li>For the meaning of the display see parameter <a href="#">0x2321:003 (P510.03)</a>.</li> </ul>	Display of the active data format.
0x232A:001 (P580.01)	Modbus statistics: Messages received (Modbus statistic:s Mess. received) <ul style="list-style-type: none"> <li>Read only</li> </ul>	Display of the total number of messages received. <ul style="list-style-type: none"> <li>This counter counts both valid and invalid messages.</li> <li>After the maximum value has been reached, the counter starts again "0".</li> </ul>
0x232A:002 (P580.02)	Modbus statistics: Valid messages received (Modbus statistic:s Val. mess. rec.) <ul style="list-style-type: none"> <li>Read only</li> </ul>	Display of the number of valid messages received. <ul style="list-style-type: none"> <li>After the maximum value has been reached, the counter starts again "0".</li> </ul>
0x232A:003 (P580.03)	Modbus statistics: Messages with exception (Modbus statistic:Mess. w. exc.) <ul style="list-style-type: none"> <li>Read only</li> </ul>	Display of the number of messages with exception that have been received. <ul style="list-style-type: none"> <li>After the maximum value has been reached, the counter starts again "0".</li> </ul>
0x232A:004 (P580.04)	Modbus statistics: Messages with errors (Modbus statistics: Mess. w. errors) <ul style="list-style-type: none"> <li>Read only</li> </ul>	Display of the number of messages received with a faulty data integrity (parity, CRC). <ul style="list-style-type: none"> <li>After the maximum value has been reached, the counter starts again "0".</li> </ul>
0x232A:005 (P580.05)	Modbus statistics: Messages sent (Modbus statistics: Messages sent) <ul style="list-style-type: none"> <li>Read only</li> </ul>	Display of the total number of messages sent. <ul style="list-style-type: none"> <li>After the maximum value has been reached, the counter starts again "0".</li> </ul>
0x232E:001 (P583.01)	Modbus diagnostics of last Rx data: Offset (Rx data diagn.: Rx data offset) 0 ... <b>[0]</b> ... 240	For purposes of diagnostics the last message received (max. 16 bytes) is shown in <a href="#">0x232E:002 (P583.02)</a> .. <a href="#">0x232E:017 (P583.17)</a> . For longer messages, an offset can be specified here, indicating from which byte of the message the display of the 16 bytes is to start.

Parameter	Name / value range / [default setting]	Info
0x232E:002 (P583.02)	Modbus diagnostics of last Rx data: Data byte 0 (Rx data diagn.: Last RxD byte0) • Read only	Display of the message received last.
0x232E:003 (P583.03)	Modbus diagnostics of last Rx data: Data byte 1 (Rx data diagn.: Last RxD byte1) • Read only	
0x232E:004 (P583.04)	Modbus diagnostics of last Rx data: Data byte 2 (Rx data diagn.: Last RxD byte2) • Read only	
0x232E:005 (P583.05)	Modbus diagnostic of last Rx data: Data byte 3 (Rx data diagn.: Last RxD byte3) • Read only	
0x232E:006 (P583.06)	Modbus diagnostic of last Rx data: Data byte 4 (Rx data diagn.: Last RxD byte4) • Read only	
0x232E:007 (P583.07)	Modbus diagnostic of last Rx data: Data byte 5 (Rx data diagn.: Letzt RxD-Byte5) • Read only	
0x232E:008 (P583.08)	Modbus diagnostic of last Rx data: Data byte 6 (Rx data diagn.: Last RxD byte6) • Read only	
0x232E:009 (P583.09)	Modbus diagnostic of last Rx data: Data byte 7 (Rx data diagn.: Last RxD byte7) • Read only	
0x232E:010 (P583.10)	Modbus diagnostic of last Rx data: Data byte 8 (Rx data diagn.: Last RxD byte8) • Read only	
0x232E:011 (P583.11)	Modbus diagnostic of last Rx data: Data byte 9 (Rx data diagn.: Last RxD byte9) • Read only	
0x232E:012 (P583.12)	Modbus diagnostic of last Rx data: Data byte 10 (Rx data diagn.: Last RxD byte10) • Read only	
0x232E:013 (P583.13)	Modbus diagnostic of last Rx data: Data byte 11 (Rx data diagn.: Last RxD byte11) • Read only	
0x232E:014 (P583.14)	Modbus diagnostic of last Rx data: Data byte 12 (Rx data diagn.: Last RxD byte12) • Read only	
0x232E:015 (P583.15)	Modbus diagnostic of last Rx data: Data byte 13 (Rx data diagn.: Last RxD byte13) • Read only	
0x232E:016 (P583.16)	Modbus diagnostic of last Rx data: Data byte 14 (Rx data diagn.: Last RxD byte14) • Read only	
0x232E:017 (P583.17)	Modbus diagnostic of last Rx data: Data byte 15 (Rx data diagn.: Last RxD byte15) • Read only	
0x232F:001 (P585.01)	Modbus diagnostic of last Tx data: Offset (Tx data diagn.: Tx data offset 0 ... [0] ... 240	For purposes of diagnostics the last message sent (max. 16 bytes) is shown in <b>0x232F:002 (P585.02)...</b> <b>0x232F:017 (P585.17)</b> . For longer messages, an offset can be specified here, indicating from which byte of the message the display of the 16 bytes is to start.

Parameter	Name / value range / [default setting]	Info
0x232F:002 (P585.02)	Modbus diagnostic of last Tx data: Data byte 0 (Tx data diagn.: Last TxD byte0) • Read only	Display of the message sent last.
0x232F:003 (P585.03)	Modbus diagnostic of last Tx data: Data byte 1 (Tx data diagn.: Last TxD Byte1) • Read only	
0x232F:004 (P585.04)	Modbus diagnostic of last Tx data: Data byte 2 (Tx data diagn.: Last TxD byte2) • Read only	
0x232F:005 (P585.05)	Modbus diagnostic of last Tx data: Data byte 3 (Tx data diagn.: Last TxD byte3) • Read only	
0x232F:006 (P585.06)	Modbus diagnostic of last Tx data: Data byte 4 (Tx data diagn.: Last TxD byte4) • Read only	
0x232F:007 (P585.07)	Modbus diagnostic of last Tx data: Data byte 5 (Tx data diagn.: Last TxD byte5) • Read only	
0x232F:008 (P585.08)	Modbus diagnostic of last Tx data: Data byte 6 (Tx data diagn.: Last TxD byte6) • Read only	
0x232F:009 (P585.09)	Modbus diagnostic of last Tx data: Data byte 7 (Tx data diagn.: Last TxD byte7) • Read only	
0x232F:010 (P585.10)	Modbus diagnostic of last Tx data: Data byte 8 (Tx data diagn.: Last TxD byte8) • Read only	
0x232F:011 (P585.11)	Modbus diagnostic of last Tx data: Data byte 9 (Tx data diagn.: Last TxD byte9) • Read only	
0x232F:012 (P585.12)	Modbus diagnostic of last Tx data: Data byte 10 (Tx data diagn.: Last TxD byte10) • Read only	
0x232F:013 (P585.13)	Modbus diagnostic of last Tx data: Data byte 11 (Tx data diagn.: Last TxD byte11) • Read only	
0x232F:014 (P585.14)	Modbus diagnostic of last Tx data: Data byte 12 (Tx data diagn.: Last TxD byte12) • Read only	
0x232F:015 (P585.15)	Modbus diagnostic of last Tx data: Data byte 13 (Tx data diagn.: Last TxD byte13) • Read only	
0x232F:016 (P585.16)	Modbus diagnostic of last Tx data: Data byte 14 (Tx data diagn.: Last TxD byte14) • Read only	
0x232F:017 (P585.17)	Modbus diagnostic of last Tx data: Data byte 15 (Tx data diagn.: Last TxD byte15) • Read only	



## 5.8 Function codes

The mode of access to inverter data (parameters) is controlled via function codes.

### Details

The inverter supports the following function codes:

Function code		Function name	Description
3	0x03	Read Holding Registers	Read one or more 16-bit data words.
6	0x06	Preset Single Register	Write a 16-bit data word.
16	0x10	Preset Multiple Registers	Write one or more 16-bit data words.
23	0x17	Read/Write 4X Registers	Within a transactio <ul style="list-style-type: none"> <li>• write into a group of connected 4X holding registers.</li> <li>• read from a group of connected 4X holding registers.</li> </ul>

### Addressing

- The function codes listed above exclusively refer to 4X registers in Modbus addressing.
- All data in the inverter can only be accessed via 4X registers, i.e. via register addresses from 40001.
- The 4xxxx reference is implicit, i. e. given by the function code used. In the frame therefore the leading 4 is omitted in the addressing process.
- Lovato supports the basic 1 addressing of Modbus, i.e. the numbering of the registers starts with 1 whereas addressing starts with 0. For example, the address 0 is used in the frame when register 40001 is read.

### Frame structure

Communication is established on the basis of the central medium access method.

Communication is always started by a master request. The inverter (slave) then either gives a valid response or outputs an error code (provided that the request has been received and evaluated as a valid Modbus frame). Error causes can be invalid CRC checksums, function codes that are not supported, or impermissible data access.

All Modbus frames have the following basic structure:

- A "frame" consists of a PDU (Protocol Data Unit) and an ADU (Application Data Unit).
- The PDU contains the function code and the data belonging to the function code.
- The ADU serves the purposes of addressing and error detection.
- The data are represented in Big Endian format (most significant byte first)

ADU (Application Data Unit)			
Slave address	Function code	Data	Checksum (CRC)
	PDU (Protocol Data Unit)		

## Error codes

In the event of an error, the node responds with a function code associated to the message:

Function code	Associated function code in the event of an error	Supported error codes
0x03	0x83	0x01, 0x02, 0x03, 0x04
0x06	0x86	0x01, 0x02, 0x03, 0x04
0x10	0x90	0x01, 0x02, 0x03, 0x04
0x17	0x97	0x01, 0x02, 0x03, 0x04

Error code	Designation	Cause(s)
0x01	Invalid function code	The function code is not supported by the inverter, or the inverter is in a state in which the request is not permissible or in which it cannot be processed.
0x02	Invalid data address	The combination of a start address and the length of the data to be transmitted is invalid. Example: If you have a slave with 100 registers, the first register has the address 0 and the last register has the address 99. If there is a request of four registers now, from the start address 96, the request can be processed successfully (for registers 96, 97, 98, and 99). If, however, five registers from the start address 96 are queried, this error code is returned, since the slave has no register with the address 100.
0x03	Invalid data value	Error in the reset structure of a complex request, e. g. because the data length that has resulted implicitly is not correct. The cause, however, is not that a (parameter) value is written outside the valid setting range. As a matter of principle, the Modbus protocol has no information on valid setting ranges of single registers or their meaning.
0x04	Slave device failure	A non-correctable error has occurred while the request was processed in the inverter.

## 5.9 Data mapping

The process of data mapping is used for defining which Modbus registers read or write to which inverter parameters.

### Details

- There are fixedly defined Modbus registers for common control and status words, which are located in consecutive blocks, in order to facilitate communication with OPC servers and other Modbus masters. In order to access all relevant data of the inverter, only a minimum number of commands is required.
- In addition, 24 registers are provided for variable mapping, i. e. free assignment to inverter parameters.

### Predefined Modbus control registers

- These registers are provided with write and read access.
- The cross-reference in column 2 leads to the detailed parameter description

Modbus registers	Permanently assigned parameter	
	Address	Name
42101	<a href="#">0x400B:001 (P592.01)</a>	AC Drive control word
42102	<a href="#">0x400B:005 (P592.05)</a>	Network setpoint frequency (0.01)
42103	<a href="#">0x4008:002 (P590.02)</a>	NetWordIN2
42104	<a href="#">0x4008:003 (P590.03)</a>	NetWordIN3
42105	<a href="#">0x400B:007 (P592.07)</a>	PID setpoint
42106	<a href="#">0x6071</a>	Target torque
42107	<a href="#">0x4008:001 (P590.01)</a>	NetWordIN1
42108	<a href="#">0x4008:004 (P590.04)</a>	NetWordIN4
42109 ... 42121	-	Reserved

### Predefined Modbus status registers

- These registers are only provided with read access.
- The cross-reference in column 2 leads to the detailed parameter description.

Modbus registers	Permanently assigned parameter	
	Address	Name
42001	<a href="#">0x400C:001 (P593.01)</a>	AC Drive status word
42002	<a href="#">0x400C:006 (P593.06)</a>	Frequency (0.01)
42003	<a href="#">0x603F (P150.00)</a>	Error code
42004	<a href="#">0x400C:005 (P593.05)</a>	Drive status
42005	<a href="#">0x2D89 (P106.00)</a>	Motor voltage
42006	<a href="#">0x2D88 (P104.00)</a>	Motor current
42007	<a href="#">0x6078 (P103.00)</a>	Current actual value
42008	<a href="#">0x2DA2:002 (P108.02)</a>	Apparent power (42008 = High Word, 42009 = Low Word)
42009		
42010	<a href="#">0x2D84:001 (P117.01)</a>	Heatsink temperature
42011	<a href="#">0x2D87 (P105.00)</a>	DC-bus voltage
42012	<a href="#">0x60FD (P118.00)</a>	Digital inputs (only bit 16 ... bit 31)
42013	<a href="#">0x6077 (P107.00)</a>	Torque actual value
42014 ... 42021	-	Reserved

### Variable mapping

- Via **0x232B:001 ... 0x232B:024 (P530.01 ... 24)**, 24 registers can be mapped to parameters of the inverter.  
Format: OxiiiiSS00 (iiii = index hexadecimal, ss = subindex hexadecimal)
- The display of the internal Modbus register numbers in **0x232C:001 ... 0x232C:024 (P531.01 ... 24)** is generated automatically. Since 32-bit parameters require two registers, there is no 1:1 assignment.
- For the mappable registers, a CRC (Cyclic Redundancy Check) is executed. The checksum determined is displayed in **0x232D (P532.00)**. The user can read this "validation code" and use it for comparison in the Modbus master. In this way it can be checked whether the inverter currently queried is configured correctly for the respective application.



Parameter	Name / value range / [default setting]	Info
0x232B:001 ... 0x232B:024 (P530.01 ... 24)	Modbus parameter mapping: Parameter 1 ... Parameter 24 (Para. mapping: Parameter 1 ... Parameter 24) 0x00000000 ... [0x00000000] ... 0xFFFFF00	Mapping entries for Modbus register 40103 ... 40149. • Format: OxiiiiSS00 (iiii = index, ss = subindex)
0x232C:001 ... 0x232C:024 (P531.01 ... 24)	Modbus register assignment: Register 1 ... Register 24 (Reg. assigned: Register 1 ... Register 24) • Read only	Display of the internal Modbus register number starting from which the parameter mapped in <b>0x232B:001 ... 0x232B:024 (P530.01 ... 24)</b> is stored. • For the first parameter mapped, always 2500. • From the second parameter mapped, 2500 + offset. The offset results from the data types of the previously mapped parameters.
0x232D (P532.00)	Modbus verification code (Verification code) • Read only	

### 5.10 LED status displays

Information about the Modbus status can be obtained quickly via the "MOD-RUN" and "MOD-ERR" LED displays on the front of the inverter.

The meaning can be seen from the tables below.

#### Inverter not active on the Modbus bus (yet)

LED "MOD-RUN"	LED "MOD-ERR"	Meaning
off	 on	Internal error
	Both LEDs are flickering alternately	Automatic detection of baud rate and data format active

#### Inverter active on the Modbus

The green "MOD-RUN" LED indicates the communication status:

LED "MOD-RUN"	Communication status
off	No reception / no transmission
 on	Reception / transmission active

The red "MOD-ERR" LED indicates an error:

LED "MOD-ERR"	Error
off	No fault
 Blinking	Communication error

### 5.11 Restart communication

The following parameter can be used to restart communication

#### Details

A restart of communication is required after changes of the interface configuration (e. g. node address and baud rate) in order that the changed settings become effective.

For restarting communication there are two options:

- a) Switch inverter off and on again.
- b) Set the selection = "Restart with current values [1]" in **0x2320 (P508.00)**.

Parameter	Name / value range / [default setting]	Info
0x2320 (P508.00)	Modbus communication (Modbus comm.)	1 = restart communication in order that changed settings of the interface configuration become effective.
	<b>0</b> No action/no error	
	1 Restart with current values	

### 5.12 Response time setting

Define a minimum time delay between the reception of a valid Modbus message and the response of the inverter.

Especially at higher baud rates, defining a minimum time delay ensures the data exchange between transmitter (Modbus master) and receiver (e. g. inverter).

Parameter	Name / value range / [default setting]	Info
0x2321:004 (P510.04)	Modbus settings:Minimum response time (Modbus sett. Min. resp. time) 0 ... [0] ... 1000 ms	

### 5.13 Short setup

In the following, the steps required for controlling the inverter via Modbus are described.

#### Parameterisation required

1. Activate network control: **0x2631:037 (P400.37) = "TRUE [1]"**
2. Set network as standard setpoint source: **0x2860:001 (P201.01) = "Network [5]"**
3. Set Modbus node address.
  - Each network node must be provided with a unique node address.
  - Details: [▶ Node address setting](#)
4. Set Modbus baud rate.
  - Default setting: Automatic detection.
  - If the automatic baud rate detection function is activated, the first 5 ... 10 messages are lost after switch-on.
  - Details: [▶ Baud rate setting](#)
5. Set Modbus data format.
  - Default setting: Automatic detection.
  - If the automatic data format detection function is activated, the first 5 ... 10 messages are lost after switch-on.
  - Details: [▶ Data format setting](#)
6. Save parameter settings **0x2022:003 (P700.03) = "on / start [1]"**.
7. Switch the inverter off and then on again in order that the changed communication settings can get effective.



In the default setting, the digital input DI1 is assigned with the "Run" function. If the network control is activated, this function serves as "start enable" for start commands via network. Hence, the digital input DI1 must be set to HIGH level in order that the motor can be started via network.

#### Starting/stopping the drive via Modbus

For starting/stopping the drive, Modbus register 42101 can be used.

- Modbus register 42101 is permanently assigned to the AC Drive control word **0x400B:001 (P592.01)**.
- In the frame, the leading 4 is omitted in the addressing process. The numbering of the registers starts with 1; addressing, however starts with 0. Therefore the address 2100 (0x0834) is used in the frame when register 42101 is written.

Bits set in the AC drive control word:

- Bit 0 ≡ Run forward (CW)
- Bit 5 ≡ Activate network control
- Bit 6 ≡ Activate network setpoint

Example of an inverter with the node address 1:

Request frame by the master							
Slave address	Function code	Data				Checksum (CRC)	
		Register address		AC Drive control word			
0x01	0x06	0x08	0x34	0x00	0x61	0x0B	0x8C

If digital input DI1 ("Start enable") is set to HIGH level, the drive should start and the inverter should respond with the same frame as confirmation:

Response message from the inverter							
Slave address	Function code	Data				Checksum (CRC)	
		Register address		AC Drive control word			
0x01	0x06	0x08	0x34	0x00	0x61	0x0B	0x8C

### Write the speed of the drive via Modbus

The drive speed can be changed via the Modbus register 42102, see [Data mapping](#).

Example of an inverter with the node address 1:

Request frame by the master							
Slave address	Function code	Data				Checksum (CRC)	
		Register address		Network setpoint frequency (0.01)			
0x01	0x06	0x08	0x35	0x04	0xD2	0x19	0x39

Response message from the inverter							
Slave address	Function code	Data				Checksum (CRC)	
		Register address		Network setpoint frequency (0.01)			
0x01	0x06	0x08	0x35	0x04	0xD2	0x19	0x39

The drive now rotates with a frequency of 12.34 Hz.

### Read the drive speed via Modbus

The drive speed can be read out via the Modbus register 42002, see [Data mapping](#). For read-ing a single register or several connected register blocks, the function code 3 is used, see [Function codes](#).

Example of an inverter with the node address 1:

Request frame by the master							
Slave address	Function code	Data				Checksum (CRC)	
		Register address		Number of words			
0x01	0x03	0x07	0xD1	0x00	0x01	0xD5	0x47

Response message from the inverter							
Slave address	Function code	Data				Checksum (CRC)	
		Read bytes		Frequency (0.01)			
0x01	0x03	0x02		0x04	0xD1	0x7A	0xD8

The drive rotates with a frequency of 12.33 Hz.

## 6 PROFIBUS



PROFIBUS® (Process Field Bus) is a widely-used fieldbus system for the automation of machines and production plants.

- Detailed information on PROFIBUS can be found on the web page of the PROFIBUS & PROFINET International (PI) user organisation: <http://www.profibus.com>
- Information about the dimensioning of a PROFIBUS network can be found in the configuration document for the inverter.
- PROFIBUS® is a registered trademark and patented technology licensed by the PROFIBUS & PROFINET International (PI) user organisation.

### Preconditions

- Logic unit of the inverter is provided with PROFIBUS (type code VLBXL02).
- The DIP switch for the node address is set correctly. See "Basic network settings".
- The GSD file is imported into the hardware configuration of the control.
  - Download of the GSD file from [www.LovatoElectric.com](http://www.LovatoElectric.com) > Downloads > Software & upgrades > Variable speed drives > Packages for VLBXSW.

### 6.1 Introduction

The inverter is integrated into a PROFIBUS-DP network as slave. Therefore it is only allowed to receive and acknowledge messages and to respond to requests by a master. The master is also referred to as an active node. Two different types are distinguished:

- Class 1 DP master: central control (PLC or PC) which cyclically exchanges process data with the slave. Acyclic data exchange via a separate transmission channel is also possible.
- Class 2 DP master: engineering, configuration, or operator device (HMI) which only exchanges data with the slave acyclically, e.g. for the purposes of configuration, maintenance, or diagnostics.

### 6.2 Typical topology

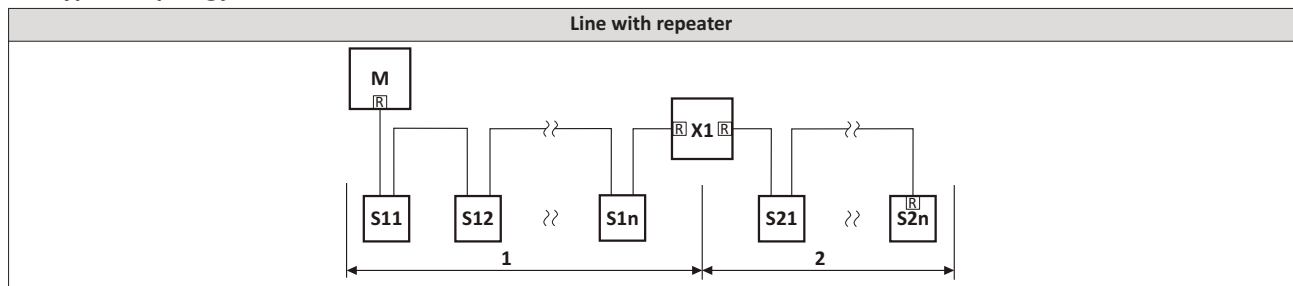

M	Master	X	Repeater
S	Slave	R	Activated bus terminating resistor

### 6.3 Communication time setting

The communication time is the time between the start of a request and the arrival of the corresponding response.

The communication time in the PROFIBUS network depend on the:

- processing time in the inverter
- Telegram runtime (baud rate/telegram length),
- nesting depth of the network.

In the case of the inverter, the processing time for process data is approx. 2 ... 3 ms, and for parameter data (DPV1) it is approx. 10 ms. There are no interdependencies between parameter data and process data.



## 6.4 Station address setting

Each network node must be provided with a unique station address.

The parameters for addressing the device are described below.

### Details

- The station address of the inverter can be optionally set via the DIP switches on the device labelled with "1" ... "64" or in [0x2341:001 \(P510.01\)](#). (The DIP switches have priority.)
- The setting that is active when the inverter is switched on is the effective setting.
- The labelling of the DIP switches corresponds to the values of the individual DIP switches for determining the station address (see the following example).
- The active station address is shown in [0x2342:001 \(P511.01\)](#).

### View of the DIP switch

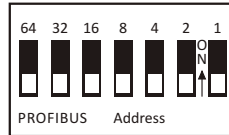

### Example of how the station address is set via the DIP switches

DIP switch	64	32	16	8	4	2	1
Setti	OFF	OFF	ON	OFF	ON	ON	ON
Value	0	0	16	0	4	2	1
Station address	= sum of all values = 16 + 4 + 2 + 1 = <b>23</b>						

Parameter	Name / value range / [default setting]	Info
0x2341:001 (P510.01)	PROFIBUS settings: Station address (PROFIBUS sett.: Station address) 1 ... [3] ... 125	Optional setting of the station address (instead of setting via DIP switches 1 ... 64). <ul style="list-style-type: none"> <li>• The station address set here only becomes effective if DIP switches 1 ... 64 have been set to OFF before mains switching.</li> <li>• A change in the station address only becomes effective after a restart of PROFIBUS communication.</li> </ul>
0x2342:001 (P511.01)	Activ PROFIBUS settings: Active station address (PROFIBUS diag.: Act.station addr) <ul style="list-style-type: none"> <li>• Read only</li> </ul>	Display of the active station address.
0x2343 (P509.00)	PROFIBUS switch position (PROFIBUS switch) <ul style="list-style-type: none"> <li>• Read only</li> </ul>	Display of the DIP switch setting at the last mains power-on. <ul style="list-style-type: none"> <li>• The displayed value corresponds to the sum of the individual DIP switch values 1 ... 64.</li> </ul>

## 6.5 Baud rate setting

At the class 1 DP master, the desired baud rate is set. All masters at the bus must be set to the same baud rate.

The parameters for the baud rate of the device are described below.

### Details

- The inverter detects the baud rate automatically
- The active baud rate is displayed in **0x2342:002 (P511.02)**.
- The status of automatic detection is displayed in **0x2348:002 (P516.02)**.

Parameter	Name / value range / [default setting]	Info
0x2342:002 (P511.02)	Activ PROFIBUS settings: Active baud rate (PROFIBUS diag.: Active baud rate) • Read only	Display of the active baud rate.
	0 12 Mbps	
	1 6 Mbps	
	2 3 Mbps	
	3 1.5 Mbps	
	4 500 kbps	
	5 187.5 kbps	
	6 93.75 kbps	
	7 45.45 kbps	
	8 19.2 kbps	
	9 9.6 kbps	
	15 Search	Automatic baud rate detection active
0x2348:002 (P516.02)	PROFIBUS Status: Watchdog status (PROFIBUS Status: Watchdog status) • Read only	Display of the current state of the watchdog state machine (WD-STATE).
	0 BAUD_SEARCH	The inverter (slave) is able to detect the baud rate automatically
	1 BAUD_CONTROL	After detecting the correct baud rate, the inverter (slave) status changes to BAUD_CONTROL, and the baud rate is monitored.
	2 DP_CONTROL	The DP_CONTROL state serves to the response monitoring of the master.

## 6.6 Monitoring

The inverter can give a parameterisable response to various PROFIBUS errors.

The parameters for setting network monitoring functions are described below.

### Details

The following table lists the PROFIBUS errors that can be set for a response.

Event	Display in	Response can be set in	Default setti
Communication to the PROFIBUS master is continuously interrupted.	0x2349 (P517.00), Bit 0	0x2859:001 (P515.01)	Error
Data exchange via PROFIBUS has been terminated.	0x2349 (P517.00), Bit 1	0x2859:002 (P515.02)	No response
The inverter has received invalid configuration data from the master.	0x2349 (P517.00), Bit 2	0x2859:003 (P515.03)	Error
An error has occurred during the initialisation of the PROFIBUS interface.	0x2349 (P517.00), Bit 3	0x2859:004 (P515.04)	Error
The process data received are invalid.	0x2349 (P517.00), Bit 4	0x2859:005 (P515.05)	Trouble

Parameter	Name / value range / [default setting]	Info
0x2342:003 (P511.03)	Activ PROFIBUS setting: Watchdog time (PROFIBUS diag.: Watchdog time) • Read only	Display of the watchdog monitoring time specified by the master. • Monitoring starts with the arrival of the first telegram. • When a value of "0" is displayed, the monitoring function is deactivated. • A change in the watchdog monitoring time in the master is effective immediately.







Parameter	Name / value range / [default setting]	Info
0x2348:002 (P516.02)	PROFIBUS Status: Watchdog status (PROFIBUS Status: Watchdog status) • Read only	Display of the current state of the watchdog state machine (WD-STATE).
	0 BAUD_SEARCH	The inverter (slave) is able to detect the baud rate automatically.
	1 BAUD_CONTROL	After detecting the correct baud rate, the inverter (slave) status changes to BAUD_CONTROL, and the baud rate is monitored.
	2 DP_CONTROL	The DP_CONTROL state serves to the response monitoring of the master.
0x2349 (P517.00)	PROFIBUS error (PROFIBUS error) • Read only	Bit-coded display of PROFIBUS errors.
	Bit 0 Watchdog elapsed	Communication with the PROFIBUS master is continuously interrupted, e. g. by cable break or failure of the PROFIBUS master. • No process data are sent to the inverter (slave) in the "Data Exchange" state. • When the watchdog monitoring time specified by the master has elapsed, the response set in <a href="#">0x2859:001 (P515.01)</a> is triggered in the inverter.  Preconditions for a response by the inverter (slave): • The slave is in the "Data Exchange" state. • The watchdog monitoring time is configured correctly in the master (1 ... 65535 ms). If one of these preconditions is not met, the response to the absence of cyclic process data telegrams from the master is not executed.
	Bit 1 Data exchange completed	Data exchange via PROFIBUS has been terminated. • The inverter (slave) can be instructed by the master to exit the "Data Exchange" state. • If this state change is to be treated as an error in the inverter, the desired response can be set in <a href="#">0x2859:002 (P515.02)</a> .
	Bit 2 Incorrect configuration data	The inverter (slave) has received invalid configuration data from the master. • The response set in <a href="#">0x2859:003 (P515.03)</a> is effected
	Bit 3 Initialisation error	An error has occurred during the initialisation of the PROFIBUS interface. • The response set in <a href="#">0x2859:004 (P515.04)</a> is effected.
	Bit 4 Invalid process data	The inverter (slave) has received invalid process data from the master, e.g. no process data or deleted process data are sent by the "Stop" operating status in the master. • The response set in <a href="#">0x2859:005 (P515.05)</a> is effected
0x2859:001 (P515.01)	PROFIBUS monitoring: Watchdog elapsed (PROFIBUS monit.: WD elapsed) • For further possible setting, see parameter <a href="#">0x2D45:001 (P310.01)</a> .	Selection of the response to the continuous interruption of communication to the PROFIBUS master, e. g. by cable break or failure of the PROFIBUS master.  Associated error code: • <a href="#">33168</a>   <a href="#">0x8190</a> - Network: watchdog timeout
	<b>2 Trouble</b>	
0x2859:002 (P515.02)	PROFIBUS monitoring: Data exchange exited (PROFIBUS monit.: Data exch.exited) • For further possible settings, see parameter <a href="#">0x2D45:001 (P310.01)</a> .	Selection of the response to exiting the "Data Exchange" state. Associated error code: • <a href="#">33169</a>   <a href="#">0x8191</a> - Network: disruption of cyclic data exchange
	<b>0 No response</b>	
0x2859:003 (P515.03)	PROFIBUS monitoring: Invalid configurati (PROFIBUS monit.: Invalid config) • For further possible settings, see parameter <a href="#">0x2D45:001 (P310.01)</a> .	Selection of the response triggered by the reception of invalid configuration data.  Associated error code: • <a href="#">33414</a>   <a href="#">0x8286</a> - Network: PDO mapping error
	<b>2 Trouble</b>	
0x2859:004 (P515.04)	PROFIBUS monitoring: Initialisation error (PROFIBUS monit.: Init. error) • For further possible settings, see parameter <a href="#">0x2D45:001 (P310.01)</a> .	Selection of the response triggered by the occurrence of an error during the initialisation of the PROFIBUS module.  Associated error code: • <a href="#">33170</a>   <a href="#">0x8192</a> - Network: initialisation error
	<b>2 Trouble</b>	

Parameter	Name / value range / [default setting]	Info
0x2859:005 (P515.05)	PROFIBUS monitoring: Invalid process data (PROFIBUS monit.: Inval. proc.data) • For further possible settings, see parameter <a href="#">0x2D45:001 (P310.01)</a> .	Selection of the response triggered by the reception of invalid process data. • If the master changes to the "Stop" state, no cyclic process data are sent to the inverter (slave) anymore; the length of the process data then is 0.  Associated error code: • <a href="#">33171</a>   <a href="#">0x8193</a> - Network: invalid cyclic process data
	<b>2 Trouble</b>	

## 6.7 LED status displays

Information about the PROFIBUS status can be obtained quickly via the "NS" and "NE" LED displays on the front of the inverter.

The meaning can be seen from the table below.

LED "NS" (green)	LED "NE" (red)	Status/meaning
off	off	No supply voltage available, network deactivated, not initialised or firmware download active.
 on		Connected with master, control running, "Data Exchange" state active.
 Blinking		Not connected, control stopped, or no data exchange.
 Blinking	 Blinking	Watchdog monitoring time elapsed.
Any	 Flashing	PROFIBUS parameterisation error.
	 Flashing 2 x	PROFIBUS configuration error.
off	 on	Invalid station address set or non-correctable error.

## 6.8 Diagnostics

The following parameters serve to diagnose the communication activities between the inverter and the PROFIBUS network.

Parameter	Name / value range / [default setting]	Info
0x2344:001 (P512.01)	PROFIBUS Configuration: Extended diagnostic bit (PROFIBUS Config. Ext. diag. bit)	1 = set external diagnostic bit ("Diag Bit"). • The diagnostic bit is sent to the master where it is evaluated separately.
	<b>0 Delete</b>	
	1 Set	
0x2348:001 (P516.01)	PROFIBUS Status: Bus status (PROFIBUS Status: Bus status) • Read only	Display of the current DP state machine state (DP-STATE).
	0 WAIT_PRM	After the run-up, the inverter (slave) is waiting for parameter data (CHK_PRM) from the master. All other frame types are not processed. Exchanging user data with the master is not possible yet.
	1 WAIT_CFG	The inverter (slave) is waiting for configuration data (CHK_CFG) from the master that define the structure of the cyclic frames.
	2 DATA_EXCH	Parameter and configuration data have been received and accepted by the inverter (slave). The inverter is in the "Data Exchange" state. It is now possible to exchange user data with the master.
0x234A:001 (P580.01)	PROFIBUS statistics: Data cycles per second (PROFIBUS counter: Data cycles/sec.) • Read only	Display of the data cycles per second.
0x234A:002 (P580.02)	PROFIBUS statistics: Parameterization events (PROFIBUS counter: PRM events) • Read only	Display of the number of parameterisation events.
0x234A:003 (P580.03)	PROFIBUS statistics: Configuration events (PROFIBUS counter: CFG events) • Read only	Display of the number of configuration events.
0x234A:004 (P580.04)	PROFIBUS statistics: Diagnostics events (PROFIBUS counter: DIAG events) • Read only	Display of the number of diagnostic telegrams sent.

Parameter	Name / value range / [default setting]	Info
0x234A:005 (P580.05)	PROFIBUS statistics: C1 messages (PROFIBUS counter: C1 messages) • Read only	Display of the number of requests by the class 1 DPV1 master.
0x234A:006 (P580.06)	PROFIBUS statistics: C2 messages (PROFIBUS counter: C2 messages) • Read only	Display of the number of requests by the class 2 DPV1 master.
0x234A:007 (P580.07)	PROFIBUS statistics: Watchdog events (PROFIBUS counter: WD events) • Read only	Display of the number of watchdog events.
0x234A:008 (P580.08)	PROFIBUS statistics: Data exchange aborts (PROFIBUS counter: DataEx.event) • Read only	Display of the number of "Data Exchange exited" events.
0x234A:009 (P580.09)	PROFIBUS statistics: Total data cycles (PROFIBUS counter: Tot. data cycles) • Read only	Display of the number of cyclic process data received.
0x2348:002 (P516.02)	PROFIBUS Status: Watchdog status (PROFIBUS Status: Watchdog status) • Read only	Display of the current state of the watchdog state machine (WD-STATE).
	0 BAUD_SEARCH	The inverter (slave) is able to detect the baud rate automatically
	1 BAUD_CONTROL	After detecting the correct baud rate, the inverter (slave) status changes to BAUD_CONTROL, and the baud rate is monitored.
	2 DP_CONTROL	The DP_CONTROL state serves to the response monitoring of the master.

## 6.9 Function

The inverter supports PROFIBUS DP-V0 (DRIVECOM profile) and PROFIBUS DP-V1 (PROFIdrive profile). PROFIBUS DP-V2 is not supported.

### Details

The PROFIBUS DP communication protocol is provided with the following functions:

- DP-V0: cyclic data exchange, diagnostics (all devices).
- DP-V1: acyclic data exchange, process alarm processing (process automation). Note: The inverter does not support any alarm diagnostics.
- DP-V2: cycle synchronisation and time stamp, slave-to-slave communication.

A class 1 DP master connection (DPV1 C1) between a cyclic master and slave is established automatically when the "Data Exchange" state has been established. In byte 7 of the parameterisation frame, the "DPV1\_Enable" bit must be set. Furthermore, a class 2 DP master connection (DPV1 C2) with the slave can be defined by another master connected. This connection must be established via the "MSAC2\_Initiate" service.

The inverter supports the following acyclic DPV1 services:

- MSAC1\_Read/Write: C1 read/write request for a data block.
- MSAC2\_Initiate/Abort: connection or disconnection for acyclic data exchange between a class 2 DP master and the slave.
- MSAC2\_Read/Write: C2 read/write request for a data block.

## 6.10 Data mapping

Data mapping is used to define which process data are exchanged cyclically between the master and slave. Data mapping is defined in the hardware configurator. The configuration of the process data is automatically sent to the inverter. The same applies to the bit configuration of the data words NetWordIN1 and NetWordOUT1.

### Details



External tools are only described as required for the corresponding network.

- The already imported GSD file serves to select the required data for the application to add the node to the PROFIBUS network configuration.
- After the start-up, the master communicates the structure of the cyclic frames to the inverter (slave) via the configuration frame (CHK\_CFG).
- The inverter checks the configuration. If the configuration is accepted, the inverter changes from the "Wait Configuration" state to the "Data Exchange" state. It is now possible to exchange user data with the master.
- The internal mapping of the cyclic data is set in 0x24E0:xxx (master → inverter direction and 0x24E1:xxx (inverter → master direction).  
Format: 0xiiiiissll (iiii = index hexadecimal, ss = subindex hexadecimal, ll = data length hexadecimal).

Parameter	Name / value range / [default setting]	Info
0x24E0:000	Generic RPDO mapping: Highest subindex 0 ... [2] ... 16	Number of mapping entries for RPDO.
0x24E0:001	Generic RPDO mapping: Entry 1 0x00000000 ... [0x60400010] ... 0xFFFFFFFF	Mapping entry 1 for RPDO.
0x24E0:002	Generic RPDO mapping: Entry 2 0x00000000 ... [0x60420010] ... 0xFFFFFFFF	Mapping entry 2 for RPDO.
0x24E0:003	Generic RPDO mapping: Entry 3 0x00000000 ... [0x00000000] ... 0xFFFFFFFF	Mapping entry 3 for RPDO.
0x24E0:004	Generic RPDO mapping: Entry 4 0x00000000 ... [0x00000000] ... 0xFFFFFFFF	Mapping entry 4 for RPDO.
0x24E0:005	Generic RPDO mapping: Entry 5 0x00000000 ... [0x00000000] ... 0xFFFFFFFF	Mapping entry 5 for RPDO.
0x24E0:006	Generic RPDO mapping: Entry 6 0x00000000 ... [0x00000000] ... 0xFFFFFFFF	Mapping entry 6 for RPDO.
0x24E0:007	Generic RPDO mapping: Entry 7 0x00000000 ... [0x00000000] ... 0xFFFFFFFF	Mapping entry 7 for RPDO.
0x24E0:008	Generic RPDO mapping: Entry 8 0x00000000 ... [0x00000000] ... 0xFFFFFFFF	Mapping entry 8 for RPDO.
0x24E0:009	Generic RPDO mapping: Entry 9 0x00000000 ... [0x00000000] ... 0xFFFFFFFF	Mapping entry 9 for RPDO.
0x24E0:010	Generic RPDO mapping: Entry 10 0x00000000 ... [0x00000000] ... 0xFFFFFFFF	Mapping entry 10 for RPDO.
0x24E0:011	Generic RPDO mapping: Entry 11 0x00000000 ... [0x00000000] ... 0xFFFFFFFF	Mapping entry 11 for RPDO.

Parameter	Name / value range / [default setting]	Info
0x24E0:012	Generic RPDO mapping: Entry 12 0x00000000 ... [0x00000000] ... 0xFFFFFFFF	Mapping entry 12 for RPDO.
0x24E0:013	Generic RPDO mapping: Entry 13 0x00000000 ... [0x00000000] ... 0xFFFFFFFF	Mapping entry 13 for RPDO.
0x24E0:014	Generic RPDO mapping: Entry 14 0x00000000 ... [0x00000000] ... 0xFFFFFFFF	Mapping entry 14 for RPDO.
0x24E0:015	Generic RPDO mapping: Entry 15 0x00000000 ... [0x00000000] ... 0xFFFFFFFF	Mapping entry 15 for RPDO.
0x24E0:016	Generic RPDO mapping: Entry 16 0x00000000 ... [0x00000000] ... 0xFFFFFFFF	Mapping entry 16 for RPDO.
0x24E1:000	Generic TPDO mapping: Highest subindex 0 ... [3] ... 16	Number of mapping entries for TPDO.
0x24E1:001	Generic TPDO mapping: Entry 1 0x00000000 ... [0x60410010] ... 0xFFFFFFFF	Mapping entry 1 for TPDO.
0x24E1:002	Generic TPDO mapping: Entry 2 0x00000000 ... [0x60440010] ... 0xFFFFFFFF	Mapping entry 2 for TPDO.
0x24E1:003	Generic TPDO mapping: Entry 3 0x00000000 ... [0x603F0010] ... 0xFFFFFFFF	Mapping entry 3 for TPDO.
0x24E1:004	Generic TPDO mapping: Entry 4 0x00000000 ... [0x00000000] ... 0xFFFFFFFF	Mapping entry 4 for TPDO.
0x24E1:005	Generic TPDO mapping: Entry 5 0x00000000 ... [0x00000000] ... 0xFFFFFFFF	Mapping entry 5 for TPDO.
0x24E1:006	Generic TPDO mapping: Entry 6 0x00000000 ... [0x00000000] ... 0xFFFFFFFF	Mapping entry 6 for TPDO.
0x24E1:007	Generic TPDO mapping: Entry 7 0x00000000 ... [0x00000000] ... 0xFFFFFFFF	Mapping entry 7 for TPDO.
0x24E1:008	Generic TPDO mapping: Entry 8 0x00000000 ... [0x00000000] ... 0xFFFFFFFF	Mapping entry 8 for TPDO.
0x24E1:009	Generic TPDO mapping: Entry 9 0x00000000 ... [0x00000000] ... 0xFFFFFFFF	Mapping entry 9 for TPDO.
0x24E1:010	Generic TPDO mapping: Entry 10 0x00000000 ... [0x00000000] ... 0xFFFFFFFF	Mapping entry 10 for TPDO.
0x24E1:011	Generic TPDO mapping: Entry 11 0x00000000 ... [0x00000000] ... 0xFFFFFFFF	Mapping entry 11 for TPDO.
0x24E1:012	Generic TPDO mapping: Entry 12 0x00000000 ... [0x00000000] ... 0xFFFFFFFF	Mapping entry 12 for TPDO.
0x24E1:013	Generic TPDO mapping: Entry 13 0x00000000 ... [0x00000000] ... 0xFFFFFFFF	Mapping entry 13 for TPDO.
0x24E1:014	Generic TPDO mapping: Entry 14 0x00000000 ... [0x00000000] ... 0xFFFFFFFF	Mapping entry 14 for TPDO.
0x24E1:015	Generic TPDO mapping: Entry 15 0x00000000 ... [0x00000000] ... 0xFFFFFFFF	Mapping entry 15 for TPDO.

Parameter	Name / value range / [default setting]	Info
0x24E1:016	Generic TPDO mapping: Entry 16 0x00000000 ... [0x00000000] ... 0xFFFFFFFF	Mapping entry 16 for TPDO.



## 6.11 Parameter data transfer

Data communication with PROFIBUS DP-V0 is characterised by cyclic diagnostics and cyclic process data transfer. An optional service expansion is the acyclic parameter data transfer of PROFIBUS DP-V1. This service does not impair the functionality of the standard services under PROFIBUS DP-V0.

### Details

- PROFIBUS DP-V0 and PROFIBUS DP-V1 can be operated simultaneously in the same network. This enables the step-by-step expansion or modification of a system.
- The services of PROFIBUS DP-V1 can be used by the class 1 master (PLC) and the class 2 DP master (diagnostics master, etc.).
- Integration of the acyclic service into the fixed bus cycle depends on the corresponding configuration of the class 1 master:
  - With configuration, a time slot is reserved.
  - Without configuration, the acyclic service is appended when a class 2 DP master acyclically accesses a DP-V1 slave.

### Product features

- 16 bits each for addressing the parameter index and subindex.
- Several parameter requests can be combined to one request (multi-parameter requests).
- Only one request is processed at a time (no pipelining).
- A request or response must fit into one data block (max. 240 bytes). Requests or responses cannot be split into several data blocks.
- No spontaneous messages are transferred.
- There are only acyclic parameter requests.
- Profile-specific parameters can be read independently of the slave state.
- A class 1 DP master can always request parameters from a slave if the slave is in the "Data Exchange" state.
- In addition to a class 1 DP master, a class 2 DP master can establish communication with a slave:

### Transmission directions for acyclic data transfer

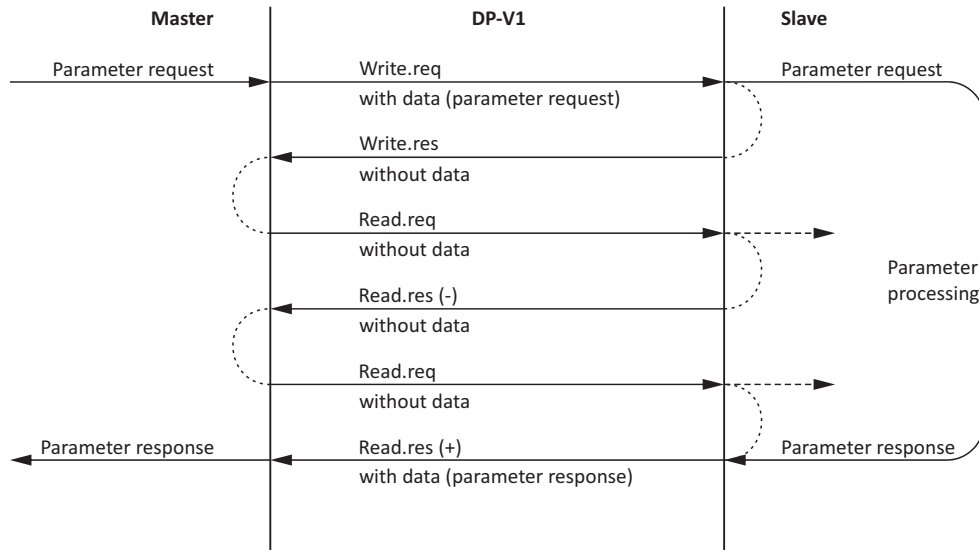

### Procedure:

1. A "Write.req" is used to pass the data set (DB47) to the slave in the form of a parameter request.
2. With "Write.res" the master receives the confirmation for the receipt of the message.
3. The master requests the response of the slave with "Read.req".
4. The slave responds with "Read.res (-)" if processing has not been completed yet.
5. After parameter processing, the parameter request is completed by transmitting the parameter response to the master with "Read.res (+)".

### Telegram structure

SD	LE	LEr	SD	DA	SA	FC	DSAP	SSAP	<b>Data Unit (DU)</b>	FCS	ED
----	----	-----	----	----	----	----	------	------	-----------------------	-----	----

The Data Unit (DU) contains the DP-V1 header and the parameter request or the parameter response. The DP V1 header consists of the function detection slot number, data set, and the length of the user data. More information about the DP-V1 header can be found in the corresponding PROFIBUS specification. A detailed description of the parameter request and parameter response can be found in the following subchapters.

### Assignment of the user data depending on the data type

Depending on the data type used, the user data are assigned as follows:

Data type	Length	User data assignment				
		Byte 1	Byte 2	Byte 3	Byte 4	Byte ...
String	x bytes	<i>Data (x bytes)</i>				
U8	1 byte	<i>Data</i>	0x00			
U16	2 bytes	HIGH byte <i>Data</i>	LOW byte <i>Data</i>			
U32	4 bytes	HIGH word		LOW word		
		HIGH byte <i>Data</i>	LOW byte <i>Data</i>	HIGH byte <i>Data</i>	LOW byte <i>Data</i>	

## 6.12 Read parameter data

This section describes the request and response for the acyclic reading of a parameter.

### Details

- When a read request is processed, no parameter value is written to the slave.
- When a read request is transmitted by multi-parameters, the parameter attribute, index and subindex are repeated.
- A read request must not exceed the maximum data length of 240 bytes.

### Request header

Byte 1	Byte 2	Byte 3	Byte 4
Request reference	Request identification	Axis	Number of indices

Field	Data type	Values
Request reference	U8	This value is defined by the master.
Request identification	U8	0x01: Request parameters for reading.
Axis	U8	0x00 or 0x01
Number of indices	U8	0x"n" (n = number of parameters requested)

### Parameter attribute

Byte 5	Byte 6
Attribute	Number of subindices

Field	Data type	Values
Attribute	U8	0x10: Value
Number of subindices	U8	0x00

### Index and subindex

Byte 7	Byte 8	Byte 9	Byte 10
Index		Subindex	
HIGH byte	LOW byte	HIGH byte	LOW byte

Field	Data type	Values
Index	U16	0x0001 ... 0xFFFF (1 ... 65535)
Subindex	U16	0x0000 ... 0x00FF (0 ... 255)

### Response to a correctly executed read request

Responses to a read request do not contain parameter attributes, indices and subindices.

### Response header

Byte 1	Byte 2	Byte 3	Byte 4
Request reference (mirrored)	Response identification	Axis (mirrored)	Number of indices

Field	Data type	Values
Request reference	U8	Mirrored value of the parameter request.
Response identification	U8	0x01: Parameter has been read.
Axis	U8	0x00 or 0x01
Number of indices	U8	0x"n" (n = number of parameters requested)

**Parameter format**

Byte 5	Byte 6	
Format	Number of values	

Field	Data type	Values
Format	U8	0x02: integer8 (1 byte with sign) 0x03: Integer16 (2 bytes with sign) 0x04: Integer32 (4 bytes with sign) 0x05: Unsigned8 (1 byte without sign) 0x06: Unsigned16 (2 bytes without sign) 0x07: Unsigned32 (4 bytes without sign) 0x09: Visible String (with n characters) 0x0A: Octet String (with n characters) 0x40: Zero 0x41: Byte 0x42: Word 0x43: Double word
Number of values	U8	0x01 or number of characters (n) for string parameters.

**Parameter value**

Byte 7	Byte 8	Byte 9	Byte 10
Value (Integer8 / Unsigned8 / byte)			
Value (Integer16 / Unsigned16 / word)			
Value (Integer32 / Unsigned32 / double word)			

Byte 7	Byte 8	Byte 9	Byte ...
String (Visible String / octet string with an optional length)			

Field	Data type	Values
Value	U8/U16/U32	Value range/length depends on the parameter format (see table above).
String	U8	Visible string / octet string with an optional length (n characters = n bytes)

**Response to a read error**

In the case of a multi-parameter request, correct and possible faulty messages are summarised in one telegram. They have the following data contents:

Correct message

- Format: data type of the value requested
- Number of values: as described above.
- Parameter value: value requested

Faulty message

- Format: 0x44
- Number of values: 0x01 or 0x02
- Error code without additional information (for number of values = 0x01) or error code with additional information (for number of values = 0x02)

A faulty access to a parameter "n" is indicated at the nth position in the response telegram of a multi-parameter request.

**Response header**

Byte 1	Byte 2	Byte 3	Byte 4
Request reference (mirrored)	Response identification	Axis (mirrored)	Number of indices

Field	Data type	Values
Request reference	U8	Mirrored value of the parameter request.
Response identification	U8	0x81: Parameter has not been read. The data in bytes 7 + 8 must be interpreted as an error code.
Axis	U8	0x00 or 0x01
Number of indices	U8	0x"n" (n = number of parameters requested)

**Parameter format**

Byte 5	Byte 6
Format	Number of values

Field	Data type	Values
Format	U8	0x44: Error
Number of values	U8	0x01: Error code without additional information 0x02: Error code with additional information

**Error code**

Byte 7	Byte 8	Byte 9	Byte 10
Error code		Additional information (if available)	
HIGH byte	LOW byte	HIGH byte	LOW byte

Field	Data type	Values
Error code	U16	0x0000 ... 0xFFFF
Additional information (if available)	U16	

### 6.13 Write parameter data

This section describes the request and response for the acyclic writing of a parameter.

#### Details

- When a multi-parameter write request is transmitted the parameter attribute, index and subindex and then the parameter format and parameter value are repeated "n" times, "n" being the number of parameters addressed.
- A write request must not exceed the maximum data length of 240 bytes.

#### Request header

Byte 1	Byte 2	Byte 3	Byte 4
Request reference	Request identification	Axis	Number of indices

Field	Data type	Values
Request reference	U8	This value is defined by the master.
Request identification	U8	0x02: Write parameters.
Axis	U8	0x00 or 0x01
Number of indices	U8	0x"n" (n = number of parameters addressed)

#### Parameter attribute

Byte 5	Byte 6
Attribute	Number of subindices

Field	Data type	Values
Attribute	U8	0x10: Value
Number of subindices	U8	0x00

#### Index and subindex

Byte 7	Byte 8	Byte 9	Byte 10
Index		Subindex	
HIGH byte	LOW byte	HIGH byte	LOW byte

Field	Data type	Values
Index	U16	0x0001 ... 0xFFFF (1 ... 65535)
Subindex	U16	0x0000 ... 0x00FF (0 ... 255)

#### Parameter format

Byte 11	Byte 12
Format	Number of values

Field	Data type	Values
Format	U8	0x02: integer8 (1 byte with sign) 0x03: Integer16 (2 bytes with sign) 0x04: Integer32 (4 bytes with sign) 0x05: Unsigned8 (1 byte without sign) 0x06: Unsigned16 (2 bytes without sign) 0x07: Unsigned32 (4 bytes without sign) 0x09: Visible String (with n characters) 0x0A: Octet String (with n characters) 0x40: Zero 0x41: Byte 0x42: Word 0x43: Double word
Number of values	U8	0x01 or number of characters (n) for string parameters.

**Parameter value**

Byte 13	Byte 14	Byte 15	Byte 16
Value (Integer8 / Unsigned8 / byte)			
Value (Integer16 / Unsigned16 / word)			
Value (Integer32 / Unsigned32 / double word)			
Byte 13	Byte 14	Byte 15	Byte ...
String (Visible string / octet string with an optional length)			
Field	Data type	Values	
Value	U8/U16/U32	Value range/length depends on the parameter format (see table above).	
String	U8	Visible string / octet string with an optional length (n characters = n bytes)	

**Response to a correctly executed write request**

With an error-free multi-parameter request, only the response header is transmitted and the complete data area is omitted.

**Response header**

Byte 1	Byte 2	Byte 3	Byte 4
Request reference (mirrored)	Response identification	Axis (mirrored)	Number of indices
Field	Data type	Values	
Request reference	U8	Mirrored value of the parameter request.	
Response identification	U8	0x02: Parameter has been written.	
Axis	U8	0x00 or 0x01	
Number of indices	U8	0x"n" (n = number of parameters addressed)	

**Response to a write error**

In the case of a multi-parameter request, correct and possible faulty messages are summarised in one telegram. They have the following data contents:

Correct message

- Format: 0x40
- Number of values: 0x00

Faulty message

- Format: 0x44
- Number of values: 0x01 or 0x02
- Error code without additional information (for number of values = 0x01) or error code with additional information (for number of values = 0x02).

A faulty access to a parameter "n" is indicated at the nth position in the response telegram of a multi-parameter request.

**Response header**

Byte 1	Byte 2	Byte 3	Byte 4
Request reference (mirrored)	Response identification	Axis (mirrored)	Number of indices
Field	Data type	Values	
Request reference	U8	Mirrored value of the parameter request.	
Response identification	U8	0x82: Parameter has not been written. The data in bytes 7 + 8 must be interpreted as an error code.	
Axis	U8	0x00 or 0x01	
Number of indices	U8	0x"n" (n = number of parameters addressed)	

**Parameter format**

Byte 5	Byte 6	
Format	Number of values	

Field	Data type	Values
Format	U8	0x44: Error
Number of values	U8	0x01: Error code without additional information 0x02: Error code with additional information

**Error code**

Byte 7	Byte 8	Byte 9	Byte 10
Error code		Additional information (if available)	
HIGH byte	LOW byte	HIGH byte	LOW byte

Field	Data type	Values
Error code	U16	0x0000 ... 0xFFFF
Additional information (if available)	U16	



## 6.14 Error codes for parameter data transfer

The following table lists all possible error codes for the acyclic data exchange:

Error code	Description	Explanation	Additional information
0x0000	Parameter number impermissible	Access to non-available parameter.	-
0x0001	Parameter value cannot be changed	Change access to a parameter value that cannot be changed.	Subindex
0x0002	Lower or upper value limit exceeded	Change access with value beyond the value limits.	Subindex
0x0003	Subindex impermissible	Access to non-available subindex.	Subindex
0x0004	No array	Access with subindex to non-indicated parameter.	-
0x0005	Incorrect data type	Change access with value that does not match the data type of the parameter.	-
0x0006	No setting permitted (only resettable)	Change access with a non-zero value where it is not permitted	Subindex
0x0007	Description element cannot be changed	Change access to a description element that cannot be changed.	Subindex
0x0008	Reserved	(PROFIdrive profile V2: PPO-Write requested in IR is not available.)	-
0x0009	Description data not available	Access to non-available description (parameter value is available).	-
0x000A	Reserved	(PROFIdrive profile V2: Wrong access group.)	-
0x000B	No parameter change rights	Change access with missing parameter change rights.	-
0x000C	Reserved	(PROFIdrive profile V2: Wrong password.)	-
0x000D	Reserved	(PROFIdrive profile V2: Text cannot be read in cyclic data transfer.)	-
0x000E	Reserved	(PROFIdrive profil V2: Name cannot be read in cyclic data transfer.)	-
0x000F	No text array available	Access to non-available text array (parameter value is available).	-
0x0010	Reserved	(PROFIdrive profile V2: No PPO-Write.)	-
0x0011	Request cannot be executed due to the operating state	Access is not possible for temporary reasons that are not specified in detail.	-
0x0012	Reserved	(PROFIdrive profile V2: Other error.)	-
0x0013	Reserved	(PROFIdrive profile V2: Date cannot be read in cyclic data transfer.)	-
0x0014	Value impermissible	Change access with the value that is within the value limits but that is impermissible for other permanent reasons (parameters with defined individual values).	Subindex
0x0015	Response too long	The length of the current response exceeds the maximum length transferrable.	-
0x0016	Parameter address impermissible	Impermissible value or value which is not supported for the attribute number of subindexes, parameter number, or subindex, or a combination	-
0x0017	Format impermissible	Write request: Impermissible or non-supported format of parameter data.	-
0x0018	Number of values not consistent	Write request: Number of parameter data values does not match the number of subindexes in the parameter address.	-
0x0019	Axis impermissible	Access to non-available axis. For double axis, only 0x00 or 0x01 permitted	-
0x001A	Reserved	-	-
...			
0x00FF			

## 6.15 Restart communication

The following parameter can be used to restart or stop communication. Optionally it is also possible to reset all communication parameters to the default status.

### Details

A restart of communication is required after changes of the interface configuration (e. g. station address and baud rate) in order that the changed settings become effective. For restarting communication, there are two options:

- a) Switch inverter off and on again.
- b) Set the selection = "Restart with current values [1]" in **0x2340**.

Parameter	Name / value range / [default setting]	Info
0x2340	PROFIBUS communication	Restart / stop communication
	<b>0</b> No action/no error	Only status feedback
	<b>1</b> Restart with current values	Restart communication with the current values.
	<b>2</b> Restart with default values	Restart communication with the standard values of the communication parameters.
	<b>5</b> Stop network communication	Stop communication
	<b>10</b> In progress	Only status feedback
	<b>11</b> Action cancelled	
	<b>12</b> Error	

## 6.16 Short setup

In the following, the steps required for controlling the inverter via PROFIBUS are described.

### Parameterisation required

1. Activate network control: [0x2631:037 \(P400.37\)](#) = "TRUE [1]"
  2. Set network as standard setpoint source: [0x2860:001 \(P201.01\)](#) = "Network [5]"
  3. Set PROFIBUS station address.
    - Each network node must be provided with a unique station address.
    - Details: [▶ Station address setting](#)
  4. Optional: Change the response of the inverter if the communication to the PROFIBUS master is interrupted.
    - Default setting: If communication is interrupted, an error is triggered.
    - Details: [▶ Monitoring](#)
  5. Save parameter settings: [0x2022:003 \(P700.03\)](#) = "On / start [1]".
  6. Switch the inverter off and then on again in order that the changed communication settings can get effective.
  7. Configure the host system (master) in order to enable communication with the inverter. See section "[Configuring the host system \(master\)](#)".
  8. Control inverter via RPDO (and evaluate in the current status via TPDO).
    - For assignment of the control word and setpoint selection, see section "[RPDO mapping](#)".
    - For assignment of the status word and actual value output, see section "[TPDO mapping](#)".
- Acceleration [0x2917 \(P220.00\)](#) and deceleration [0x2918 \(P221.00\)](#) can be set/changed via the acyclic parameter data transfer.



In the default setting the digital input DI1 is assigned with the "Run" function. If the network control is activated this function serves as "start enable" for start commands via network. Hence, the digital input DI1 must be set to HIGH level in order that the motor can be started via network. [▶ Start / stop motor](#)

### Configuring the host system (master)

Configure the host system (master) as follows in order to enable communication with the inverter.

1. Import the device description file of the inverter into the master.
 

The device description file for the inverter can be download from the website [www.LovatoElectric.com](http://www.LovatoElectric.com) > Downloads > Software & Upgrades > Variable speed drives > Packages for VLBXSW.

The following language versions of the device description file can be used:

  - LOVATO[product type].GSE (source file, English), e.g. VLBXE550.GSE for VLB3
  - LOVATO[product type].GSG (German), e.g. VLBXE550.GSG for VLB3
  - LOVATO[product type].GSE (English), e.g. VLBXE550.GSE for VLB3
2. Define the user data length.
  - The user data length is defined during the initialisation phase of the master.
  - The inverter supports the configuration of maximally 16 process data words (maximally 32 bytes).
  - The user data length for process input data and process output data is the same.
3. Execute data mapping in the hardware configurator
  - For preconfigured PDO mapping, see the sections "[RPDO mapping](#)" and "[TPDO mapping](#)".
  - Details: [▶ Data mapping](#)

## RPDO mapping

For the process data from the master to the inverter, the following data mapping is preset in the device description file:

1. NetWordIN1 data word0x4008:001 (P590.01)
2. Network setpoint frequency (0.01) 0x400B:005 (P592.05)
3. 16 bit selectable output data, mapped to Keypad setpoints: Process controller setpoint 0x2601:002 (P202.02)

### Function assignment of the NetWordIN1 data word

Bit	Default setting	For details and configuration, see
0	Not active (reserve)	0x400E:001 (P505.01)
1	Not active (reserve)	0x400E:002 (P505.02)
2	Activate quick stop	0x400E:003 (P505.03)
3	Not active (reserve)	0x400E:004 (P505.04)
4	Run forward (CW)	0x400E:005 (P505.05)
5	Activate preset (bit 0)	0x400E:006 (P505.06)
6	Activate preset (bit 1)	0x400E:007 (P505.07)
7	Reset error	0x400E:008 (P505.08)
8	Not active (reserve)	0x400E:009 (P505.09)
9	Activate DC braking	0x400E:010 (P505.10)
10	Not active (reserve)	0x400E:011 (P505.11)
11	Not active (reserve)	0x400E:012 (P505.12)
12	Reverse rotational direction	0x400E:013 (P505.13)
13	Not active (reserve)	0x400E:014 (P505.14)
14	Not active (reserve)	0x400E:015 (P505.15)
15	Not active (reserve)	0x400E:016 (P505.16)

#### Specifying the frequency setpoint

- The specification is made unsigned (independent of the direction of rotation) as integer in the resolution [0.01 Hz].
- The direction of rotation is defined in the default setting via bit 12 of the NetWordIN1 data word.
- Example: 4560  $\equiv$  45.60 Hz

## TPDO mapping

For the process data from the inverter to the master, the following data mapping is preset in the device description file.

1. NetWordOUT1 data word [0x400A:001 \(P591.01\)](#)
2. Network setpoint frequency (0.01) [0x400B:005 \(P592.05\)](#)
3. Motor current [0x2D88 \(P104.00\)](#)

### Status assignment of the NetWordOUT1 data word

Bit	Default setting	For details and configuration, see
0	Ready for operation	<a href="#">0x2634:010 (P420.10)</a>
1	Not connected	<a href="#">0x2634:011 (P420.11)</a>
2	Operation enabled	<a href="#">0x2634:012 (P420.12)</a>
3	Error active	<a href="#">0x2634:013 (P420.13)</a>
4	Not connected	<a href="#">0x2634:014 (P420.14)</a>
5	Quick stop active	<a href="#">0x2634:015 (P420.15)</a>
6	Running	<a href="#">0x2634:016 (P420.16)</a>
7	Device warning active	<a href="#">0x2634:017 (P420.17)</a>
8	Not connected	<a href="#">0x2634:018 (P420.18)</a>
9	Not connected	<a href="#">0x2634:019 (P420.19)</a>
10	Setpoint speed reached	<a href="#">0x2634:020 (P420.20)</a>
11	Current limit reached	<a href="#">0x2634:021 (P420.21)</a>
12	Actual speed = 0	<a href="#">0x2634:022 (P420.22)</a>
13	Rotational direction reversed	<a href="#">0x2634:023 (P420.23)</a>
14	Release holding brake	<a href="#">0x2634:024 (P420.24)</a>
15	Safe torque off (STO) activ	<a href="#">0x2634:025 (P420.25)</a>

### Output of the actual frequency value

- The output is made unsigned (independent of the direction of rotation) as integer in the resolution [0.01 Hz].
- An active reversal is displayed via bit 13 of the NetWordOUT1 data word.
- Example: 4560  $\equiv$  45.60 Hz

## 7 PROFINET

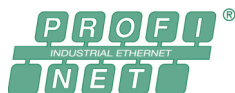

PROFINET® (Process Field Network) is a real-time capable fieldbus system based on Ethernet.

- Detailed information on PROFINET can be found on the web page of the PROFIBUS & PROFINET International (PI) user organisation: <http://www.profibus.com>
- Information about the dimensioning of a PROFINET network can be found in the configuration document for the inverter.
- PROFINET® is a registered trademark and patented technology licensed by the PROFIBUS & PROFINET International (PI) user organisation.

### Preconditions

- Logic unit of the inverter is provided with PROFINET (type code VLBXL03).
- The required GSDML device description files for PROFINET are installed in the engineering tool for configuring the network.
  - Download of GSDML files from [www.LovatoElectric.com](http://www.LovatoElectric.com) > Downloads > Software & upgrades > Variable speed drives > Packages for VLBXSW.

### 7.1 Introduction

The inverter is implemented as IO-Device into a PROFINET network. PROFINET transmits parameter data, configuration data, diagnostic data, alarm messages and process data between the IO-Devices and the IO-Controller (in the following, this term is used instead of "PLC" or "host system").

The data is transmitted as a function of its time-critical behaviour via corresponding communication channels.

### Supported services

Features	Inverter
Conformance	Class CCB
Option according to conformance class	Media Redundancy Protocol
Device class	IO device
According to PN specification	V2.2
Safety channel support	-
Shared device	-
Device access	TCI, I&M0 ... 4
Device profile support	-
Conductor access	OK
The second inverter	Yes
Fast startup	No. (typical starting times, approx. 11 seconds)
Topology support	LLDP MIB, station alias
PN blinking function	OK
Alarm type	User
Acylic services	OK
Additional Ethernet channel	TCP/IP channel
GCI support	OK
ESDCP support	OK
Power over Ethernet PoE	-
External 24V current supply	X3 24E / GND
Optical fiber support	-

## 7.2 Typical topology

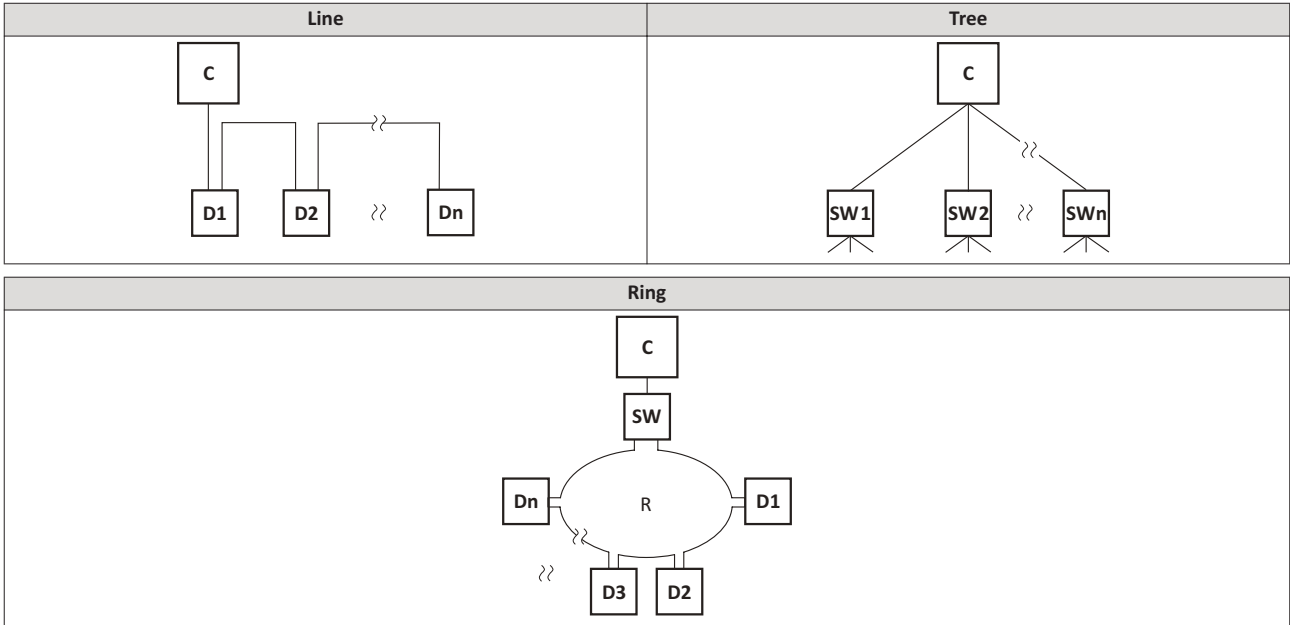

C IO controller  
D IO device

SW Switch SCALANCE (MRP capable)  
R Redundant domain



The rotary encoder switch has no function

### 7.3 Basic settings

For communicating with the inverter, the IO controller must be configured.

The configuration of the IO controller comprises:

- the loading of the device description file into the IO controller,
- the assignment of a station name for the inverter and
- the assignment of an IP address for the inverter.

The station name and the IP address are assigned by the IO controller. The assignment can also be made by the Lovato engineering tool VLBXSW.

#### Preconditions

- The entire wiring of the inverter has already been checked for completeness, short circuit and earth fault.
- The GSDML device description file for PROFINET must be downloaded from [www.LovatoElectric.com](http://www.LovatoElectric.com) > Downloads > Software & upgrades > Variable speed drives > Packages for VLBXSW.

#### Device description file

The current device description file is installed in the engineering tool used for configuring the network. Thus, an unambiguous station name is assigned to the inverter which makes it possible for the IO controller to identify the device in the network and manage the data exchange with the other network nodes.

The designation of the device description file is as follows:

"GSDML-V<x>.<z>-Lovato-<NNN>PN<Version>-<yyyy><mm><dd>.xml".

The information in the wildcards (angle brackets) are explained in the following:

Wildcard	Info
x	Major version of the used GSDML scheme
z	Minor version of the used GSDML scheme
NNN	Specifying the inverter designation, e.g. <VLB3>
Version	First software version that can be used with this GSDML. This data must not be changed.
yyyy	Year of publication
mm	Month of publication
dd	Day of publication

Tab. 2: Explanation of the wildcards in the designation of the device description file.

#### Station name

The station name is required for the clear addressing of the inverter by the IO controller.

The station name of the inverter must be entered into the [0x2381:004 \(P510.04\)](#) parameter with permissible characters according to the PROFINET specification.

The characters permissible for the name allocation are given in the specification.

The station name is read out with [0x2382:004 \(P511.04\)](#).

#### IP address

The IP address makes it possible to access the inverter in the entire network.

For configuring the IP address, the subnet mask and gateway address must also be assigned:

- [0x2381:001 \(P510.01\)](#): IP address
- [0x2381:002 \(P510.02\)](#): Subnet mask
- [0x2381:003 \(P510.03\)](#): Gateway address

All three settings are read out with the parameters [0x2382:001 \(P511.01\)](#) ... [0x2382:003 \(P511.03\)](#).





Parameter	Name / value range / [default setting]	Info
0x2380 (P508.00)	PROFINET communication (PROFINET comm.)	Restart / stop communication <ul style="list-style-type: none"> <li>When the device command has been executed successfully, the value 0 is shown.</li> </ul>
	<b>0</b> No action/no error	Only status feedback
	1 Restart with current values	Restart communication with the current values.
	2 Restart with default values	Restart communication with the standard values of the PROFINET parameters (0x2381:001 ... 0x2381:009).
	5 Stop network communication	Stop communication
	10 In process	Only status feedback
	11 Action cancelled	
12 Fault		
0x2381:001 (P510.01)	PROFINET settings: IP address (PROFINET sett.: IP address) 0 ... [0] ... 4294967295	Set IP address <ul style="list-style-type: none"> <li>The change of this parameter becomes only effective after a restart.</li> </ul>
0x2381:002 (P510.02)	PROFINET settings: Subnet (PROFINET sett.: Subnet) 0 ... [0] ... 4294967295	Set subnet mask <ul style="list-style-type: none"> <li>The change of this parameter becomes only effective after a restart.</li> </ul>
0x2381:003 (P510.03)	PROFINET settings: Gateway (PROFINET sett.: Gateway) 0 ... [0] ... 4294967295	Set gateway address <ul style="list-style-type: none"> <li>The gateway address is valid if the network address of the IP address is identical to the gateway address. In this case, no gateway functionality is used.</li> <li>DHCP is not supported.</li> <li>The change of this parameter becomes only effective after a restart.</li> </ul>
0x2381:004 (P510.04)	PROFINET settings: Station name (PROFINET sett.: Station name)	Set station name <ul style="list-style-type: none"> <li>The change of this parameter becomes only effective after a restart.</li> </ul>
0x2381:005	PROFINET settings: I&M1 System designatio	Input/output of the I&M1 system designation <ul style="list-style-type: none"> <li>The default setting is an empty string.</li> </ul>
0x2381:006	PROFINET settings: I&M1 Installation site	Input/output of the I&M1 location identificatopm code <ul style="list-style-type: none"> <li>The default setting is an empty string.</li> </ul>
0x2381:007	PROFINET settings: I&M2 Installation date	Input/output of the I&M1 date of installation <ul style="list-style-type: none"> <li>The default setting is an empty string.</li> </ul>
0x2381:008	PROFINET settings: I&M3 additional information	Input/output of the I&M1 additional information <ul style="list-style-type: none"> <li>The default setting is an empty string.</li> </ul>
0x2381:009	PROFINET settings: I&M4 signature code	Input/output of the I&M1 signature <ul style="list-style-type: none"> <li>The default setting is an empty string.</li> </ul>



## 7.4 LED status displays

Information on the network status can be obtained quickly via the "BUS RDY" and "BUS ERR" LED displays on the front of the inverter. In addition the LEDs at the RJ45 sockets indicate the PROFINET connectin status.

The meaning of the "BUS RDY" and "BUS ERR" LEDs can be obtained from the following two tables.

LED "BUS RDY" (green)	Status/meaning
off	No connection to the master
 blinking	PLC in STOP
 on	PLC in RUN (DATA_EXCHANGE)

LED "BUS ERR" (red)	Status/meaning
off	No fault
 flicker	The PROFINET function "Node flashing test" is triggered by the IO controller. The flickering LED serves to identify (locate) accessible IO devices
 blinking	Impermissible settings: Stack, station name or IP parameters are invalid.
 on (red)	Communication error (e.g. Ethernet cable removed)

### Status displays at the RJ45 sockets

The LEDs at the RJ45 sockets indicate the connection status to the network:

LED "Link" (green)	Status/meaning
off	No connection to the network.
 on	A physical connection to the network is available.

LED "Activity"(yellow)	Status/meaning
off	No data transfer.
 on or flicker	Data is exchanged via the network.

## 7.5 Diagnostics

The parameters for diagnosing the network are described below.

Parameter	Name / value range / [default setting]	Info
0x2382:001 (P511.01)	Active PROFINET settings: IP address (PROFINET diag.: IP address) • Read only	Display of the active IP address.
0x2382:002 (P511.02)	Active PROFINET settings: Subnet (PROFINET diag.: Subnet) • Read only	Display of the active subnet mask.
0x2382:003 (P511.03)	Active PROFINET settings: Gateway (PROFINET diag.: Gateway) • Read only	Display of the gateway address.
0x2382:004 (P511.04)	Active PROFINET settings: Station name (PROFINET diag.: Station name) • Read only	Display of the active station name.
0x2382:005 (P511.05)	Active PROFINET settings: MAC Address (PROFINET diag.: MAC Address) • Read only	Display of the active MAC address.

Parameter	Name / value range / [default setting]	Info
0x2388 (P516.00)	PROFINET status (PROFINET status) • Read only	Bit coded display of the current Bus status.
	Bit 0 Initialize	After initialisation, the network component waits for a communication partner and the system power-up.
	Bit 1 Online	
	Bit 2 Connected	
	Bit 3 IP address error	The IP address is invalid. Valid IP addresses are defined according to RFC 3330.
	Bit 4 Hardware fault	
	Bit 6 Watchdog elapsed	PROFINET communication is continuously interrupted in the "Data_Exchange" state, e.g. by cable break or failure of the IO Controller. • PROFINET communication changes to the "No_Data_Exchange" state. When the watchdog monitoring time specified by the IO Controller has elapsed, the response set in <a href="#">0x2859:001 (P515.01)</a> is triggered in the inverter.
	Bit 7 Protocol error	
	Bit 8 PROFINET stack ok	
	Bit 9 PROFINET stack not configured	
	Bit 10 Ethernet controller fault	
	Bit 11 UDP stack fault	
0x2389:001 (P517.01)	PROFINET error: Error 1 (PROFINET error: Error 1) • Read only	The parameter currently contains the error detected on the network. • The error values may occur in combination with the error values from parameter <a href="#">0x2389:002 (P517.02)</a> .
	0 No error	
	1 Reserved	
	2 Unit ID unknown	
	3 Max. units exceeded	
	4 Invalid size	
	5 Unit type unknown	
	6 Runtime plug error	
	7 Invalid argument	
	8 Service pending	
	9 Stack not ready	
	10 Command unknown	
	11 Invalid address descriptor	
0x2389:002 (P517.02)	PROFINET error: Error 2 (PROFINET error: Error2) • Read only	The parameter currently contains the error detected on the network. • The error values may occur in combination with the error values from parameter <a href="#">0x2389:001 (P517.01)</a> .
	Bit 7 IP address error	The IP address is invalid. Valid IP addresses are defined according to RFC 3330.
	Bit 8 Station name problem	The station name must be assigned according to the PROFINET specification.
	Bit 9 DataExch left	
	Bit 10 Stack boot error	
	Bit 11 Stack online error	
	Bit 12 Stack state error	
	Bit 13 Stack revision error	
	Bit 14 Initialization problem	
Bit 15 Stack init error	The stack cannot be initiated with the user specifications. A reason might be, e. g., a station name that does not correspond to the PROFINET specification.	

## 7.6 Monitoring

The parameters for setting network monitoring function are described below.

Parameter	Name / value range / [default setting]	Info
0x2859:001 (P515.01)	PROFINET monitoring: Watchdog elapsed (PROFINET monit.: WD elapsed)	Selection of the response to a permanent interruption of the communication to the IO controller. Associated error code: • 33168   0x8190 - Network: watchdog timeout
	<ul style="list-style-type: none"> <li>For further possible settings, see parameter <a href="#">0x2D45:001 (P310.01)</a>.</li> </ul> <b>2 Trouble</b>	
0x2859:002 (P515.02)	PROFINET monitoring: Data exchange exited (PROFINET monit.: Data exch.exited)	
	<ul style="list-style-type: none"> <li>For further possible settings, see parameter <a href="#">0x2D45:001 (P310.01)</a>.</li> </ul> <b>0 No response</b>	
0x2859:003 (P515.03)	PROFINET monitoring: Invalid configurati (PROFINET monit.: Invalid config)	Selection of the response triggered by the reception of invalid configuration data. Associated error code: • 33414   0x8286 - Network: PDO mapping error
	<ul style="list-style-type: none"> <li>For further possible settings, see parameter <a href="#">0x2D45:001 (P310.01)</a>.</li> </ul> <b>2 Trouble</b>	
0x2859:004 (P515.04)	PROFINET monitoring: Initialisation error (PROFINET monit.: Init. error)	Selection of the response triggered by the occurrence of an error during the initialisation of the network component. Associated error code: • 33170   0x8192 - Network: initialisation error
	<ul style="list-style-type: none"> <li>For further possible settings, see parameter <a href="#">0x2D45:001 (P310.01)</a>.</li> </ul> <b>2 Trouble</b>	
0x2859:005 (P515.05)	PROFINET monitoring: Invalid process data (PROFINET monit.: Inval. proc.data)	Selection of the response triggered by the reception of invalid process data. Process data marked as invalid (IOPS is "BAD") are received by the IO Controller. Typically in case of • a PLC in STOP state, • alarms, • acyclic demand data. Associated error code: • 33171   0x8193 - Network: invalid cyclic process data
	<ul style="list-style-type: none"> <li>For further possible settings, see parameter <a href="#">0x2D45:001 (P310.01)</a>.</li> </ul> <b>2 Trouble</b>	

## 7.7 Data mapping

The process data are used to control the inverter.

The process data is transmitted cyclically between the IO-Controller and the IO-Devices participating at the PROFINET:

- The available 27 network registers ("slots") serve to maximally exchange 16 process data words (data types 8-bit or 16-bit) or 8 process data double words (data type 32-bit) for each direction
- Output data direction From IO-Controller to IO-Device.
- Input data direction From IO-Device to IO-Controller.

Data mapping is used to define which process data are exchanged cyclically between IO-Controller and IO-Device.

### Details

- If the inverter is known in the PROFINET network as node and the IO-Controller connects to the IO-Device for the first time the mapping objects are automatically transferred to the IO device, i. e. to the inverter.
- Internal mapping of the process output data is set in [0x24E0:001 ... 0x24E0:016](#).
- Internal mapping of the process input data is set in [0x24E1:001 ... 0x24E1:016](#).



All subsequent changes in the objects [0x24E0](#) and [0x24E1](#) can cause PROFINET alarms according to the deviation of the automatically set configurations.

---

## RPDO mapping



The assignment of different bits with the same function is not permissible.

For the process data from the master to the inverter, the following data mapping is preset in the device description file:

1. NetWordIN1 data word [0x4008:001 \(P590.01\)](#)
2. Network setpoint frequency (0.01) [0x400B:005 \(P592.05\)](#)
3. 16 bit selectable output data, mapped to Keypad setpoints: Process controller setpoint [0x2601:002 \(P202.02\)](#)

### Function assignment of the NetWordIN1 data word

Bit	Default setting	For details and configuration see
0	Not active (reserve)	<a href="#">0x400E:001 (P505.01)</a>
1	Not active (reserve)	<a href="#">0x400E:002 (P505.02)</a>
2	Activate quick stop	<a href="#">0x400E:003 (P505.03)</a>
3	Not active (reserve)	<a href="#">0x400E:004 (P505.04)</a>
4	Run forward (CW)	<a href="#">0x400E:005 (P505.05)</a>
5	Activate preset (bit 0)	<a href="#">0x400E:006 (P505.06)</a>
6	Activate preset (bit 1)	<a href="#">0x400E:007 (P505.07)</a>
7	Reset error	<a href="#">0x400E:008 (P505.08)</a>
8	Not active (reserve)	<a href="#">0x400E:009 (P505.09)</a>
9	Activate DC braking	<a href="#">0x400E:010 (P505.10)</a>
10	Not active (reserve)	<a href="#">0x400E:011 (P505.11)</a>
11	Not active (reserve)	<a href="#">0x400E:012 (P505.12)</a>
12	Reverse rotational direction	<a href="#">0x400E:013 (P505.13)</a>
13	Not active (reserve)	<a href="#">0x400E:014 (P505.14)</a>
14	Not active (reserve)	<a href="#">0x400E:015 (P505.15)</a>
15	Not active (reserve)	<a href="#">0x400E:016 (P505.16)</a>

#### Specifying the frequency setpoint

- The specification is made unsigned (independent of the direction of rotation as integer in the resolution [0.01 Hz]).
- The direction of rotation is defined in the default setting via bit 12 of the NetWordIN1 data word.
- Example: 4560  $\equiv$  45.60 Hz

## TPDO mapping



The assignment of different bits with the same function is not permissible.

For the process data from the inverter to the master, the following data mapping is preset in the device description file.

1. NetWordOUT1 data word [0x400A:001 \(P591.01\)](#)
2. Frequency (0.01) [0x400C:006 \(P593.06\)](#)
3. Motor current [0x2D88 \(P104.00\)](#)

### Status assignment of the NetWordOUT1 data word

Bit	Default setting	For details and configuration see
0	Ready for operation	<a href="#">0x2634:010 (P420.10)</a>
1	Not connected	<a href="#">0x2634:011 (P420.11)</a>
2	Operation enabled	<a href="#">0x2634:012 (P420.12)</a>
3	Error active	<a href="#">0x2634:013 (P420.13)</a>
4	Not connected	<a href="#">0x2634:014 (P420.14)</a>
5	Quick stop active	<a href="#">0x2634:015 (P420.15)</a>
6	Running	<a href="#">0x2634:016 (P420.16)</a>
7	Device warning active	<a href="#">0x2634:017 (P420.17)</a>
8	Not connected	<a href="#">0x2634:018 (P420.18)</a>
9	Not connected	<a href="#">0x2634:019 (P420.19)</a>
10	Setpoint speed reached	<a href="#">0x2634:020 (P420.20)</a>
11	Current limit reached	<a href="#">0x2634:021 (P420.21)</a>
12	Actual speed = 0	<a href="#">0x2634:022 (P420.22)</a>
13	Rotational direction reversed	<a href="#">0x2634:023 (P420.23)</a>
14	Release holding brake	<a href="#">0x2634:024 (P420.24)</a>
15	Safe torque off (STO) active	<a href="#">0x2634:025 (P420.25)</a>

### Output of the actual frequency value

- The output is made unsigned (independent of the direction of rotation) as integer in the resolution [0.01 Hz].
- An active reversal is displayed via bit 13 of the NetWordOUT1 data word.
- Example: 4560  $\equiv$  45.60 Hz

### Example for changing a pre-assigned mapping

The assignment of the third output word is to be changed. Due to the device description file this output word (designation "16 bit selectable OUT-data\_1") has already been assigned with the keypad setpoint.

The keypad setpoint ([0x2601:002 \(P202.02\)](#)) is to be replaced by the acceleration ramp ([0x2917 \(P220.00\)](#)).

Proceeding

1. Mark the 3rd output word in the "Device view".
2. Select the "Module parameter" dialog in "Properties"
  - a) Display in "Index": 9729 (decimal form of the index 0x2601)
  - b) Display in "Subindex": 2
3. Replace keypad setpoint [0x2601:002 \(P202.02\)](#) by acceleration ramp [0x2917 \(P220.00\)](#)
  - a) Use the [Parameter attribute list](#) to check whether mapping is permitted for the current parameter to be mapped and the data type is complied with.
  - b) Entry in "Index": 10519 (decimal form of the index 0x2917)
  - c) Entry in "Subindex": 0



---

The acceleration time must be defined later, e.g. at the FB LCB\_ActuatorSpeed, input wFreeCtrl, with the factor 10 (10 s  $\equiv$  100).

---



## 7.8 Parameter data transfer

Data communication with PROFINET is characterised by the simultaneous operation of cyclic and acyclic services in the network. As an optional extension, the parameter data transfer belongs to the acyclic services.

### Details

- Only one parameter request is processed at a time (no pipelining).
- No spontaneous messages are transferred.
- There are only acyclic parameter requests.
- Profile-specific parameters can be independently of the states of the IO-Device.

An IO-Controller can always request parameters from the IO-Device if the IO-Device is in the DATA\_EXCHANGE state.

### Transmission direction for acyclic data transfer

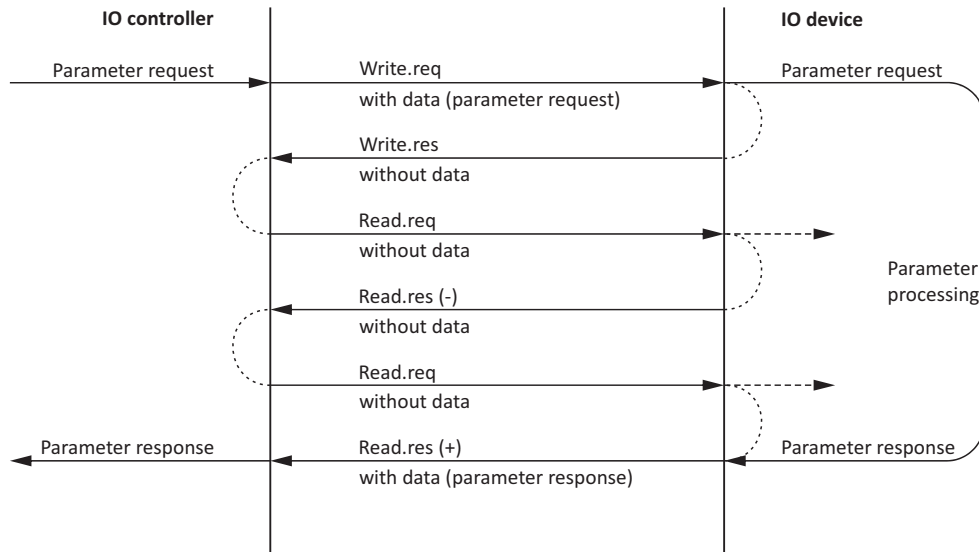

1. A "Write.req" is used to transmit the data set (DB47) to the IO-Device in the form of a parameter request.
2. With "Write.res", the IO-Controller receives the confirmation for the receipt of the message.
3. The IO-Controller requests the response of the IO-Device with "Read-req".
4. The IO-Device responds with a "Read.res (-)" if processing has not been completed yet.
5. After parameter processing, the parameter request is completed by transmitting the parameter response to the IO-Controller with "Read.res (+)".

### Telegram structure

Destr	ScrAddr	VLAN	Type 0x0800	RPC	NDR	Read/Write Block	Data	FCS
6 bytes	6 bytes	4 bytes	4 bytes	80 bytes	64 bytes	64 bytes	0 ... 240 bytes	4 bytes

In the **Read / Write Block** field, the initiator specifies the access to the "DB47" data set. The data that is written on this index or read by it, contain a header and the parameter request or the parameter response. The read data or the data to be written are contained in the **Data** field.

### Assignment of the user data depending on the data type

Depending on the data type used, the user data are assigned as follows:

Data type	Length	User data assignment				
		Byte 1	Byte 2	Byte 3	Byte 4	Byte ...
String	x bytes	<i>Data (x bytes)</i>				
U8	1 byte	<i>Data</i>	0x00			
U16	2 bytes	HIGH byte	LOW byte			
		<i>Data</i>	<i>Data</i>			
U32	4 bytes	HIGH word		LOW word		
		HIGH byte	LOW byte	HIGH byte	LOW byte	
		<i>Data</i>	<i>Data</i>	<i>Data</i>	<i>Data</i>	

## 7.9 Short setup

In the following, the steps required for controlling the inverter via PROFINET are described.

### Parameterisation required



On the control side, all commissioning steps are carried out with the engineering tool of an original equipment manufacturer (e.g. »Siemens TIA Portal«). Please note that in the standard setting of the used engineering tool, changes of network parameters carried out by Lovato VLBXSW software may be overwritten.

1. Go to the device configuration and open the "net view" to drag the inverter from the catalog to the net view of the PROFINET.

Condition: The device description file has been installed before, see [Basic settings](#).

2. Assign the inverter to the associated IO controller.
3. Mark the inverter and change to the "device view".
4. Set the IP address and the station name ("PROFINET device name") in "Properties"

For setting of the IP address and the station name, see [Basic settings](#).



In order that the inverter can be identified via Ethernet when the IO controller is switched off, it is necessary that the IP address is saved in the inverter with mains failure protection via the separate entry with the VLBXSW software.

Use the [0x2022:003 \(P700.03\)](#) parameter for saving the settings.

5. Activate network control: [0x2631:037 \(P400.37\)](#) = "TRUE [1]"
6. Set network as standard setpoint source: [0x2860:001 \(P201.01\)](#) = "Network [5]"
7. Below the module name and the name of the device description file, the device view shows the pre-assignment of three output and input process data objects (TPDO / RPDO) each:

Module
L-Controlword 0x4008:01 _1
Netwfreq. 0.01Hz 0x400B:05 _1
16Bit selectable OUT-Data _1
L-Statusword 0x400A:01 _1
Act.freq. 0.01Hz 0x400C:06 _1
Act.mot.current 0x2D88:00 _1

- In the device view further process data words can be added or preassigned PDOs can be changed. Please make sure that all addresses of the input and output data words follow each other without any gaps.
  - Please observe the description for data mapping, see [Data mapping](#) and the subsequent "example for changing a pre-assigned mapping".
8. Save configuration in the engineering tool.
  9. Load project into the IO controller.
  10. Get the IO controller to "RUN", e.g. by setting bit 4 in the control word NetWordIN1 [0x400E:005 \(P505.05\)](#).
    - The startup causes the current configuration to be transferred to the inverter.
    - If required, save mapping and all other parameters in the inverter with mains failure protection.

## Restart or stop communication

The following parameter can be used to restart or stop communication. Optionally it is also possible to reset all communication parameters to the default status.

A restart of communication is required after changes of the interface configuration (e. g. station address and baud rate) in order that the changed settings become effective. For restarting communication there are two options:

1. Switch inverter off and on again.
2. Set the selection = "Restart with current values [1]" in [0x2380 \(P508.00\)](#).

Parameter	Name / value range / [default setting]	Info
0x2022:003 (P700.03)	Device commands: Save user data (Device commands: Save user data) • For further possible setting, see parameter <a href="#">0x2022:001 (P700.01)</a> .	1 = save current parameter settings in the main memory of the memory module with mains failure protection • It may take some seconds to execute the task. When the task has been executed successfully, the value 0 is shown. • Do not switch off the supply voltage during the saving process and do not unplug the memory module from the inverter! • When the inverter is switched on, all parameters are automatically loaded from the main memory of the memory module to the RAM memory of the inverter.
	0 Off / ready	
0x2381:004 (P510.04)	PROFINET settings: Station name (PROFINET sett.: Station name)	Set station name • The change of this parameter becomes only effective after a restart.
0x2382:001 (P511.01)	Active PROFINET settings: IP address (PROFINET diag.: IP address) • Read only	Display of the active IP address.
0x2382:004 (P511.04)	Active PROFINET settings: Station name (PROFINET diag.: Station name) • Read only	Display of the active station name.
0x2388 (P516.00)	PROFINET status (PROFINET status) • Read only	Bit coded display of the current Bus status.
	Bit 0 Initialize	After initialisation the network component waits for a communication partner and the system power-up.
	Bit 1 Online	
	Bit 2 Connected	
	Bit 3 IP address error	The IP address is invalid. Valid IP addresses are defined according to RFC 3330.
	Bit 4 Hardware fault	
	Bit 6 Watchdog elapsed	PROFINET communication is continuously interrupted in the "Data_Exchange" state, e.g. by cable break or failure of the IO Controller. • PROFINET communication changes to the "No_Data_Exchange" state. When the watchdog monitoring time specified by the IO Controller has elapsed, the response set in <a href="#">0x2859:001 (P515.01)</a> is triggered in the inverter.
	Bit 7 Protocol error	
	Bit 8 PROFINET stack ok	
	Bit 9 PROFINET stack not configure	
Bit 10 Ethernet controller fault		
Bit 11 UDP stack fault		

Parameter	Name / value range / [default setting]	Info
0x2631:002 (P400.02)	Function list: Run (Function list: Run) <ul style="list-style-type: none"> <li>Setting can only be changed if the inverter is inhibited.</li> <li>For further possible settings, see parameter <a href="#">0x2631:001 (P400.01)</a>.</li> </ul>	Assignment of a trigger to the "Run" function  <b>Function 1: Start / stop motor (default setting)</b> Function 1 is active if no further start commands (start forward/start reverse) have been connected to triggers, no keypad control is active and no network control is active Trigger = TRUE: Let motor rotate forward (CW). Trigger = FALSE: Stop motor.  Notes to function 1: <ul style="list-style-type: none"> <li>If "Enable inverter" <a href="#">0x2631:001 (P400.01)</a> = "Constant TRUE [1]", only a digital input is permissible as trigger for this function in order that the motor can be stopped again any time.                Exception If the "Safe torque o (STO)" safety function is available, both function "Enable inverter" and "Run" can be set to "Constant TRUE [1]". The inverter is then controlled via the STO signal unless no other start commands (start-forward/start-backward) have been connected to triggers.</li> <li>The stop method can be selected in <a href="#">0x2838:003 (P203.03)</a>.</li> <li>The function also serves to realise an automatic start after switch-on.</li> </ul>
	<b>11 Digital input 1</b>	<b>Function 2: Start enable/stop motor</b> Function 2 is active if further start commands have been connected to triggers, keypad control is active or network control is active Trigger = TRUE: Start commands of the active control source are enabled. Trigger = FALSE: Stop motor.  Notes to function 2: <ul style="list-style-type: none"> <li>If no separate start enable is required for the application, the trigger "Constant TRUE [1]" must be set.</li> <li>The stop method can be selected in <a href="#">0x2838:003 (P203.03)</a>.</li> </ul>
0x2631:037 (P400.37)	Function list: Activate network control (Function list: Network control) <ul style="list-style-type: none"> <li>For further possible settings, see parameter <a href="#">0x2631:001 (P400.01)</a>.</li> </ul>	Assignment of a trigger for the "Activate network control" function. Trigger = TRUE: Activate network control. Trigger = FALSE: No action / deactivate network control again.
	<b>0 Not connected</b>	
	114 Network control active	TRUE if the network control is requested via bit 5 of the AC drive control word <a href="#">0x400B:001 (P592.01)</a> . Otherwise FALSE.  Notes: <ul style="list-style-type: none"> <li>Set this selection if the network control is to be activated via bit 5 of the AC drive control word.</li> <li>The AC drive control word can be used with any communication protocol.</li> </ul> <a href="#">▶ AC Drive Profile</a>
0x2859:001 (P515.01)	PROFINET monitoring: Watchdog elapsed (PROFINET monit.: WD elapsed) <ul style="list-style-type: none"> <li>For further possible settings, see parameter <a href="#">0x2D45:001 (P310.01)</a>.</li> </ul>	Selection of the response to a permanent interruption of the communication to the IO controller.  Associated error code: <ul style="list-style-type: none"> <li><a href="#">33168</a>   <a href="#">0x8190</a> - Network: watchdog timeout</li> </ul>
	<b>2 Trouble</b>	
0x2860:001 (P201.01)	Frequency control: Default setpoint source (Std. setpoints: Freq. setp. src.)	Selection of the standard setpoint source for operating mode "MS: Velocity mode". <ul style="list-style-type: none"> <li>The selected standard setpoint source is always active in the operating mode <a href="#">0x6060 (P301.00)</a> = "MS: Velocity mode [-2]" when no setpoint change-over to another setpoint source via corresponding triggers/function is active.</li> </ul>
	1 Keypad	The setpoint is specified locally by the keypad. <ul style="list-style-type: none"> <li>Default setting: <a href="#">0x2601:001 (P202.01)</a></li> <li>Use the <b>↑</b> and <b>↓</b> navigation keys to change the keypad setpoint (also during running operation).</li> </ul>
	<b>2 Analog input 1</b>	The setpoint is defined as analog signal via the analog input 1.

Parameter	Name / value range / [default setting]	Info
	3 Analog input 2	The setpoint is defined as analog signal via the analog input 2.
	4 HTL input (from version 4.1)	The digital inputs DI3 and DI4 can be configured as HTL input to use an HTL encoder as setpoint encoder or define the setpoint as a reference frequency ("pulse train").
	5 Network	The setpoint is defined as process data object via the network.
	11 Frequency preset 1	For the setpoint selection, preset values can be parameterised and selected.
	12 Frequency preset 2	
	13 Frequency preset 3	
	14 Frequency preset 4	
	15 Frequency preset 5	
	16 Frequency preset 6	
	17 Frequency preset 7	
	18 Frequency preset 8	
	19 Frequency preset 9	
	20 Frequency preset 10	
	21 Frequency preset 11	
	22 Frequency preset 12	
	23 Frequency preset 13	
	24 Frequency preset 14	
	25 Frequency preset 15	
	31 Segment preset 1 (from version 4.1)	For the setpoint selection, the segment presets parameterised for the "sequencer" function can be selected as well.
	32 Segment preset 2 (from version 4.1)	
	33 Segment preset 3 (from version 4.1)	
	34 Segment preset 4 (from version 4.1)	
	35 Segment preset 5 (from version 4.1)	
	36 Segment preset 6 (from version 4.1)	
	37 Segment preset 7 (from version 4.1)	
	38 Segment preset 8 (from version 4.1)	
	50 Motor potentiometer	The setpoint is generated by the "motor potentiometer" function. This function can be used as an alternative setpoint control which is controlled via two signals: "MOP setpoint up" and "MOP setpoint down".
	201 Internal value (from version 5.1)	Internal values of the manufacturer.
	202 Internal value (from version 5.1)	
	203 Internal value (from version 5.1)	
	204 Internal value (from version 5.1)	
	205 Internal value (from version 5.1)	
	206 Internal value (from version 5.1)	
0x2D88 (P104.00)	Motor current (Motor current) • Read only: x.x A	Display present current r.m.s. value.

Parameter	Name / value range / [default setting]	Info
0x4008:001 (P590.01)	Process input words: NetWordIN1 (NetWordINx: NetWordIN1) 0x0000 ... [0x0000] ... 0xFFFF	Mappable data word for flexible control of the inverter via network.
	Bit 0 Mapping bit 0	Assignment of the function <a href="#">0x400E:001 (P505.01)</a>
	Bit 1 Mapping bit 1	Assignment of the function <a href="#">0x400E:002 (P505.02)</a>
	Bit 2 Mapping bit 2	Assignment of the function <a href="#">0x400E:003 (P505.03)</a>
	Bit 3 Mapping bit 3	Assignment of the function <a href="#">0x400E:004 (P505.04)</a>
	Bit 4 Mapping bit 4	Assignment of the function <a href="#">0x400E:005 (P505.05)</a>
	Bit 5 Mapping bit 5	Assignment of the function <a href="#">0x400E:006 (P505.06)</a>
	Bit 6 Mapping bit 6	Assignment of the function <a href="#">0x400E:007 (P505.07)</a>
	Bit 7 Mapping bit 7	Assignment of the function <a href="#">0x400E:008 (P505.08)</a>
	Bit 8 Mapping bit 8	Assignment of the function <a href="#">0x400E:009 (P505.09)</a>
	Bit 9 Mapping bit 9	Assignment of the function <a href="#">0x400E:010 (P505.10)</a>
	Bit 10 Mapping bit 10	Assignment of the function <a href="#">0x400E:011 (P505.11)</a>
	Bit 11 Mapping bit 11	Assignment of the function <a href="#">0x400E:012 (P505.12)</a>
	Bit 12 Mapping bit 12	Assignment of the function <a href="#">0x400E:013 (P505.13)</a> Alternatively, this mapping bit can be used for controlling the digital outputs.  Assignment of the digital outputs: <ul style="list-style-type: none"> <li>Relay: <a href="#">0x2634:001 (P420.01)</a> / selection [30]</li> <li>Digital output 1: <a href="#">0x2634:002 (P420.02)</a> / selection [30]</li> </ul> <p>Note! Do not assign the mapping bit to a function and a digital output at the same time. A double assignment can cause an unpredictable drive behaviour!</p>
	Bit 13 Mapping bit 13	Assignment of the function <a href="#">0x400E:014 (P505.14)</a> Alternatively, this mapping bit can be used for controlling the digital outputs.  Assignment of the digital outputs: <ul style="list-style-type: none"> <li>Relay: <a href="#">0x2634:001 (P420.01)</a> / selection [31]</li> <li>Digital output 1: <a href="#">0x2634:002 (P420.02)</a> / selection [31]</li> </ul> <p>Note! Do not assign the mapping bit to a function and a digital output at the same time. A double assignment can cause an unpredictable drive behaviour!</p>
	Bit 14 Mapping bit 14	Assignment of the function <a href="#">0x400E:015 (P505.15)</a> Alternatively, this mapping bit can be used for controlling the digital outputs.  Assignment of the digital outputs: <ul style="list-style-type: none"> <li>Relay: <a href="#">0x2634:001 (P420.01)</a> / selection [32]</li> <li>Digital output 1: <a href="#">0x2634:002 (P420.02)</a> / selection [32]</li> </ul> <p>Note! Do not assign the mapping bit to a function and a digital output at the same time. A double assignment can cause an unpredictable drive behaviour!</p>
Bit 15 Mapping bit 15	Assignment of the function <a href="#">0x400E:016 (P505.16)</a> Alternatively, this mapping bit can be used for controlling the digital outputs.  Assignment of the digital outputs: <ul style="list-style-type: none"> <li>Relay: <a href="#">0x2634:001 (P420.01)</a> / selection [33]</li> <li>Digital output 1: <a href="#">0x2634:002 (P420.02)</a> / selection [33]</li> </ul> <p>Note! Do not assign the mapping bit to a function and a digital output at the same time. A double assignment can cause an unpredictable drive behaviour!</p>	

Parameter	Name / value range / [default setting]	Info
0x400A:001 (P591.01)	Process output words: NetWordOUT1 (NetWordOUTx: NetWordOUT1) • Read only	Mappable data word for the output of status messages of the inverter via network.
	Bit 0 Mapping bit 0	Mappable data word for the output of status messages of the inverter via network. Assignment of the status message: <a href="#">0x2634:010 (P420.10)</a>
	Bit 1 Mapping bit 1	Mappable data word for the output of status messages of the inverter via network. Assignment of the status message: <a href="#">0x2634:011 (P420.11)</a>
	Bit 2 Mapping bit 2	Mappable data word for the output of status messages of the inverter via network. Assignment of the status message: <a href="#">0x2634:012 (P420.12)</a>
	Bit 3 Mapping bit 3	Mappable data word for the output of status messages of the inverter via network. Assignment of the status message: <a href="#">0x2634:013 (P420.13)</a>
	Bit 4 Mapping bit 4	Mappable data word for the output of status messages of the inverter via network. Assignment of the status message: <a href="#">0x2634:014 (P420.14)</a>
	Bit 5 Mapping bit 5	Mappable data word for the output of status messages of the inverter via network. Assignment of the status message: <a href="#">0x2634:015 (P420.15)</a>
	Bit 6 Mapping bit 6	Mappable data word for the output of status messages of the inverter via network. Assignment of the status message: <a href="#">0x2634:016 (P420.16)</a>
	Bit 7 Mapping bit 7	Mappable data word for the output of status messages of the inverter via network. Assignment of the status message: <a href="#">0x2634:017 (P420.17)</a>
	Bit 8 Mapping bit 8	Mappable data word for the output of status messages of the inverter via network. Assignment of the status message: <a href="#">0x2634:018 (P420.18)</a>
	Bit 9 Mapping bit 9	Mappable data word for the output of status messages of the inverter via network. Assignment of the status message: <a href="#">0x2634:019 (P420.19)</a>
	Bit 10 Mapping bit 10	Mappable data word for the output of status messages of the inverter via network. Assignment of the status message: <a href="#">0x2634:020 (P420.20)</a>
	Bit 11 Mapping bit 11	Mappable data word for the output of status messages of the inverter via network. Assignment of the status message: <a href="#">0x2634:021 (P420.21)</a>
	Bit 12 Mapping bit 12	Mappable data word for the output of status messages of the inverter via network. Assignment of the status message: <a href="#">0x2634:022 (P420.22)</a>
	Bit 13 Mapping bit 13	Mappable data word for the output of status messages of the inverter via network. Assignment of the status message: <a href="#">0x2634:023 (P420.23)</a>
	Bit 14 Mapping bit 14	Mappable data word for the output of status messages of the inverter via network. Assignment of the status message: <a href="#">0x2634:024 (P420.24)</a>
Bit 15 Mapping bit 15	Mappable data word for the output of status messages of the inverter via network. Assignment of the status message: <a href="#">0x2634:025 (P420.25)</a>	
0x400B:005 (P592.05)	Process input data: Network setpoint frequency (0.01) (Process data IN: Net.freq. 0.01) 0.00 ... <b>[0.00]</b> ... 599.00 Hz	Mappable parameter for specifying the frequency setpoint in [0.01 Hz] via network. • The specification is made without sign (irrespective of the rotating direction). • The rotating direction is specified via the control word. • Example: 456 ≙ 4.56 Hz
0x400C:006 (P593.06)	Process output data: Frequency (0.01) (Process data OUT: Frequency 0.01) • Read only: x.xx Hz	Mappable parameter for the output of the actual frequency value in [0.01 Hz] via network. • The output is effected without sign (irrespective of the rotating direction). • The rotating direction is specified via the status word. • Example: 456 ≙ 4.56 Hz



## 8 EtherCAT



EtherCAT® (Ethernet for Controller and Automation Technology) is an Ethernet-based fieldbus system which fulfils the application profile for industrial realtime systems.

- EtherCAT® is a registered trademark and patented technology, licensed by Beckhoff Automation GmbH, Germany.
- Detailed information on EtherCAT can be found on the web page of EtherCAT Technology Group (ETG): <http://www.ethercat.or>
- Information about the dimensioning of an EtherCAT network can be found in the configuration document for the inverter.

### Precondition

- The logic unit of the inverter is provided with EtherCAT (type code VLBXL04).
- For commissioning, the »PLC Designer« and current device description files for EtherCAT are available:
  - Download »PLC Designer«
  - Download XML/ESI files from [www.LovatoElectric.com](http://www.LovatoElectric.com) > Downloads > Software & upgrades > Variable speed drives > Packages for VLBXSW.

### Properties and supported services

Properties / supported services	
CoE (CANopen over EtherCAT)	✓
FSoE (Fail Safety over EtherCAT)	-
Operating modes	<ul style="list-style-type: none"> <li>• Free run</li> <li>• Config</li> <li>• Run</li> </ul>
Access	<ul style="list-style-type: none"> <li>• Logical write (W)</li> <li>• Logical read/write (RW)</li> </ul>
Maximum process data length per direction (Rx/Tx)	32 bytes
FMMU (Fieldbus Memory Management Units)	3*
SM (Sync-Managers)	4
DC synchronisation	-
Topology addressing	✓
Second slave addressing	Only via EEPROM
Explicit Device Identification Mode	✓
✓ Is supported. - Is not supported. * Available for data mapping.	

### Restart of the network communication

The network communication is restarted with **0x2360 (P508.00) = 1**.

Parameter	Name / value range / [default setting]	Info
0x2360 (P508.00)	EtherCAT communication (EtherCAT comm.)	Restart communication <ul style="list-style-type: none"> <li>• When the device command has been executed successfully, the value 0 is shown.</li> </ul>
	<b>0</b> No action/no error	Only status feedback
	<b>1</b> Restart with current values	Restart communication with the current values.
	<b>10</b> In process	Only status feedback
	<b>11</b> Action cancelled	
	<b>12</b> Fault	

## 8.1 Typical topology

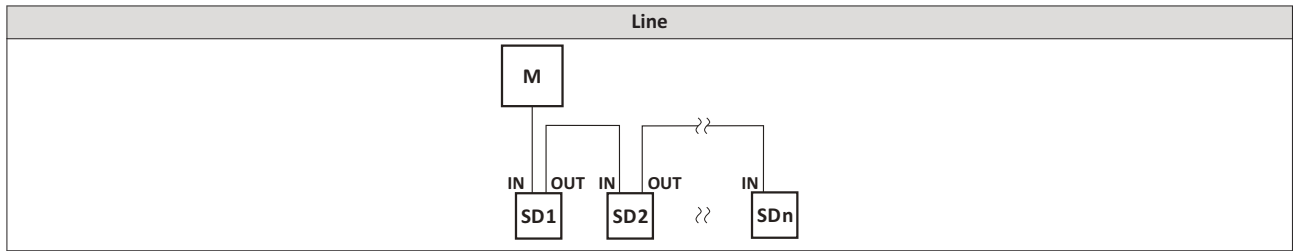

M     Master  
SD     Slave Device

## 8.2 Device identification

The EtherCAT objects for identifying the devices are described below.

The objects can only be accessed via the EtherCAT network.

Parameter	Name / value range / [default setting]	Info
0x1000	Device type • Read only	CANopen device profile according CANopen specification CiA 301/ CiA 402.
0x1008	Manufacturer device name • Read only	Display of the manufacturer device name.
0x1009	Manufacturer hardware version • Read only	Display of the manufacturer hardware version.
0x100A	Manufacturer software version • Read only	Display of the manufacturer software version.
0x1018:001	Identity object: Vendor ID • Read only	Display of the manufacturer's identification number.
0x1018:002	Identity object: Product ID • Read only	Display of the product code of the inverter.
0x1018:003	Identity object: Revision number • Read only	Display of the main and subversion of the firmware.
0x1018:004	Identity object: Serial number • Read only	Display of the serial number of the inverter.

## 8.3 EtherCAT configuration

### Addressing the EtherCAT devices

The EtherCAT devices are normally addressed via a permanent 16-bit address defined by the master. At the start, this address is assigned automatically to each node by the master, depending on the physical order in the network. The address is not saved and gets lost when the device is switched off.

#### "Explicit Device Identification" via rotary encoder switch or parameter

The "Explicit Device Identification" is required if the device is part of a "Hot Connect" group or the device is operated within a modular Lovato machine application. Each slave receives an *unambiguous* identifier for being identified by the master.

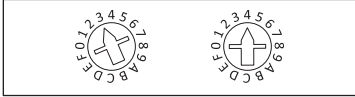
Setting	Assignment of the identifier
0x00	Identifier via the parameter 0x2361:004 (P510.04).
0x01 ... 0xFF	Identifier via the rotary encoder switches. <b>Example:</b> Setting for the value 52 $(3 \times 16) + (4 \times 1) = 52$ <div style="text-align: center; margin-top: 10px;">  </div>

The value set via the rotary encoder switches is used once when the mains is switched on or after a network restart with 0x2360 (P508.00) = 1. A changed value during operation will only become valid after the network has been restarted.

As an alternative, a master can also use station alias addresses of the slaves that are configured and *unambiguous* in the network. For this purpose, a station alias address must be saved in the EEPROM of the device by setting the corresponding register.





The parameters for addressing the device are described below.



Parameter	Name / value range / [default setting]	Info
0x2361:004 (P510.04)	EtherCAT settings: Device identifier (EtherCAT sett. Device ident.) 0 ... [0] ... 65535	Setting of the identifier <i>unambiguous</i> in the network (Explicit Device Identification). This setting is only valid for rotary encoder switch setting 0 (0x00).
0x2363 (P509.00)	EtherCAT switch position (EtherC. switch) • Read only	Display of the current rotary encoder switch settings.

## 8.4 LED status displays



Information on the network status can be obtained quickly via the "BUS RDY" and "BUS ERR" LED displays on the front of the inverter. In addition, the LEDs at the RJ45 sockets indicate the EtherCAT connection status.

The meaning of the "BUS RDY" and "BUS ERR" LEDs can be obtained from the following two tables.

LED "BUS RDY" (green)	EtherCAT status	Status/meaning
off	off / Init	The network option is not active at the network or is in the "Init" status.
 blinking	Pre-Operational	Access to parameters and objects possible. No process data exchange.
 on	Safe-Operational	The data is not active yet in the standard device.
 on	Operational	The network option works correctly.
 flicker	Bootstrap	Firmware update of the network option active

LED "BUS ERR" (red)	Status/meaning
off	No fault
 flicker	Local error. The network option changes automatically to the "Safe-Operational" status.
 on (red)	A "Sync Manager Watchdog Timeout" has occurred.
 blinking	The configuration is invalid/incorrect.

The LED "L/A" at the RJ45 sockets show the connection status to the network:

LED "L/A" (green)	Status/meaning
off	No connection to the network.
 flicker	Data is exchanged via the network.
 on	A physical connection to the network is available.

## 8.5 Diagnostics

The parameters for diagnosing the network are described below.

Parameter	Name / value range / [default setting]	Info
0x2362:004 (P511.04)	Active EtherCAT settings: Device identifier (EtherCAT diag.: Device ident.) • Read only	Display of the clear device address in the network which is defined via rotary encoder switch or object 0x2361:004 (P510.04).
0x2362:006 (P511.06)	Active EtherCAT settings: Station address (EtherCAT diag.: Station address) • Read only	Display of the active station address.
0x2362:007 (P511.07)	Active EtherCAT settings: Tx length (EtherCAT diag.: Tx length) • Read only	Display of the length of the transmitted cyclic data in bytes.
0x2362:008 (P511.08)	Active EtherCAT settings: Rx length (EtherCAT diag.: Rx length) • Read only	Display of the length of the received cyclic data in bytes.

Parameter	Name / value range / [default setting]	Info
0x2368 (P516.00)	EtherCAT status (EtherCAT status) • Read only	Display of the current network status.
	1 Initialisation	Network initialisation is active. • No PDO/SDO transmission. • Device identification is possible by network scan.
	2 Pre-Operational	The network is active. • SDO transmission (CoE communication via mailbox) is possible. • No PDO transmission.
	3 Bootstrap	Firmware update active • For the firmware update, the FoE protocol is used. • No PDO transmission.
	4 Safe-Operational	SDO transmission (CoE communication via mailbox) is possible. PDO transmission: • The input data in the process image are updated. • The output data from the process image are not transmitted
	8 Operational	Normal operation • PDO/SDO transmission is possible. • Network synchronisation is successful (if used).
0x2369 (P517.00)	EtherCAT error (EtherCAT error) • Read only	Bit coded display of EtherCAT errors.

## 8.6 Monitoring

The parameters for setting network monitoring function are described below.

Parameter	Name / value range / [default setting]	Info
0x2859:001 (P515.01)	EtherCAT monitoring: Watchdog elapsed (EtherCAT monit.: WD elapsed)  • For further possible settings, see parameter <a href="#">0x2D45:001 (P310.01)</a> .	Selectin of the response to the continuous interruption of communication to the EtherCAT master, e. g. by cable break or failure of the EtherCAT master.  Associated error code: • <a href="#">33168</a>   <a href="#">0x8190</a> - Network: watchdog timeout
	<b>2 Trouble</b>	
0x2859:003 (P515.03)	EtherCAT monitoring: Invalid configuration (EtherCAT monit.: Invalid config)  • For further possible setting see parameter <a href="#">0x2D45:001 (P310.01)</a> .	Selection of the response triggered by the reception of invalid configuration data.  Associated error code: • <a href="#">33414</a>   <a href="#">0x8286</a> - Network: PDO mapping error
	<b>2 Trouble</b>	
0x2859:004 (P515.04)	EtherCAT monitoring: Initialisation error (EtherCAT monit.: Init. error)  • For further possible settings, see parameter <a href="#">0x2D45:001 (P310.01)</a> .	Selection of the response triggered by the occurrence of an error during the initialisation of the network component.  Associated error code: • <a href="#">33170</a>   <a href="#">0x8192</a> - Network: initialisation error
	<b>2 Trouble</b>	
0x2859:005 (P515.05)	EtherCAT monitoring: Invalid process data (EtherCAT monit.: Inval. proc.data)  • For further possible settings, see parameter <a href="#">0x2D45:001 (P310.01)</a> .	Selection of the response triggered by the reception of invalid process data.  Associated error code: • <a href="#">33171</a>   <a href="#">0x8193</a> - Network: invalid cyclic process data
	<b>2 Trouble</b>	

## 8.7 Objects

The parameters for the implemented EtherCAT objects are described below.

Parameter	Name / value range / [default setting]	Info
0x2360 (P508.00)	EtherCAT communicatio (EtherCAT comm.)	Restart communication. <ul style="list-style-type: none"> <li>When the device command has been executed successfully, the value 0 is shown.</li> </ul>
	<b>0</b> No action/no error	Only status feedback
	1 Restart with current values	Restart communication with the current values.
	10 In process	Only status feedback
	11 Action cancelled	
	12 Fault	
0x2361:004 (P510.04)	EtherCAT settings: Device identifier (EtherCAT sett. Device ident.) 0 ... [0] ... 65535	Setting of the identifier <i>unambiguous</i> in the network (Explicit Device Identification). This setting is only valid for rotary encoder switch setting 0 (0x00).
0x2362:004 (P511.04)	Active EtherCAT settings: Device identifier (EtherCAT diag.: Device ident.) <ul style="list-style-type: none"> <li>Read only</li> </ul>	Display of the clear device address in the network which is defined via rotary encoder switch or object 0x2361:004 (P510.04).
0x2362:006 (P511.06)	Active EtherCAT settings: Station address (EtherCAT diag.: Station address) <ul style="list-style-type: none"> <li>Read only</li> </ul>	Display of the active station address.
0x2362:007 (P511.07)	Active EtherCAT settings: Tx length (EtherCAT diag.: Tx length) <ul style="list-style-type: none"> <li>Read only</li> </ul>	Display of the length of the transmitted cyclic data in bytes.
0x2362:008 (P511.08)	Active EtherCAT settings: Rx length (EtherCAT diag.: Rx length) <ul style="list-style-type: none"> <li>Read only</li> </ul>	Display of the length of the received cyclic data in bytes.
0x2363 (P509.00)	EtherCAT switch position (EtherC. switch) <ul style="list-style-type: none"> <li>Read only</li> </ul>	Display of the current rotary encoder switch setting
0x2368 (P516.00)	EtherCAT status (EtherCAT status) <ul style="list-style-type: none"> <li>Read only</li> </ul>	Display of the current network status.
	1 Initialisation	Network initialisation is active <ul style="list-style-type: none"> <li>No PDO/SDO transmission.</li> <li>Device identification is possible by network scan.</li> </ul>
	2 Pre-Operational	The network is active. <ul style="list-style-type: none"> <li>SDO transmission (CoE communication via mailbox) is possible.</li> <li>No PDO transmission.</li> </ul>
	3 Bootstrap	Firmware update active. <ul style="list-style-type: none"> <li>For the firmware update, the FoE protocol is used.</li> <li>No PDO transmission.</li> </ul>
	4 Safe-Operational	SDO transmission (CoE communication via mailbox) is possible. PDO transmission: <ul style="list-style-type: none"> <li>The input data in the process image are updated.</li> <li>The output data from the process image are not transmitted</li> </ul>
	8 Operational	Normal operation. <ul style="list-style-type: none"> <li>PDO/SDO transmission is possible.</li> <li>Network synchronisation is successful (if used).</li> </ul>
0x2369 (P517.00)	EtherCAT error (EtherCAT error) <ul style="list-style-type: none"> <li>Read only</li> </ul>	Bit coded display of EtherCAT errors.

## 8.8 Process data transfer

- Process data are cyclically transferred between the EtherCAT master and the slaves (permanent exchange of current input and output data).
- The transfer of process data is time-critical.
- The process data serve to control the EtherCAT slaves.
- The process data can be directly accessed by the master. The data in the PLC, for instance, are directly stored in the I/O area.
- The contents of the process data are defined via I/O Data mapping (definition of the EtherCAT objects that are to be transmitted cyclically).
- Process data are not saved in the device.
- Process data are, e. g. setpoints, actual values, control and status words.

### Configurati

- The available objects can be mapped in the CiA 402 operating mode "CiA: Velocity mode" (0x6060 (P301.00) = 2) and as dynamic (free) configuration. The contents can be selected from all mappable objects.
  - Mapping objects for the CiA 402 operating mode "CiA: Velocity mode": 0x1603:001 and 0x1603:002 (RPDOs), 0x1A03:001 ... 0x1A03:003 (TPDOs)
  - Mapping objects for a dynamic (free) assignment: 0x1605:001 ... 0x1605:016 (RPDOs), 0x1A05:001 ... 0x1A05:016 (TPDOs)
- The freely configurable mapping objects contain an 8 bit dummy entry (0x00050008). This ensures that each object is transferred cyclically with 16 bits.
- Mapping is executed in the master configuration and automatically transferred to the slave.
- The data format is 0xAAAABBCC (AAAA = index, BB = subindex, CC = length).

### Standard mapping of the RPDOs in the CiA 402 operating mode "CiA: Velocity mode"

Master → slave	
0x1603:001 RPDO mapping entry 1 (CiA: Velocity mode)	CiA: Controlword (0x6040)
0x1603:002 RPDO mapping entry 2 (CiA: Velocity mode)	CiA 402 parameter "Target velocity" (0x6042 (P781.00))
0x1605:001 RPDO mapping Entry 1 (freely configurable)	Not assigned.

### Standard mapping of the TPDOs in the CiA 402 operating mode "CiA: Velocity mode"

Slave → master	
0x1A03:001 TPDO mapping entry 1 (CiA: Velocity mode)	CiA: Statusword (0x6041 (P780.00))
0x1A03:002 TPDO mapping entry 2 (CiA: Velocity mode)	CiA 402 parameter "Velocity actual value" (0x6044 (P783.00))
0x1A03:003 TPDO mapping entry 3 (CiA: Velocity mode)	Error code (0x603F (P150.00))
0x1A05:001 TPDO mapping entry 1 (freely configurable)	Digital inputs

### Expert settings

- The sync managers are configured for the cyclic data transfer an the mailbox communication (display in 0x1C00:001 ... 0x1C00:004).
- For the communication, the I/O data mapping must be configured via 0x1C12:000 ... 0x1C12:002 (for RPDOs) and 0x1C13:000 ... 0x1C13:002 (for TPDOs).
- The basic settings for the sync managers are made via 0x1C32:001 ... 0x1C32:005 and 0x1C33:001 ... 0x1C33:005.

In the following, the EtherCAT objects are described (Mapping-Objekt-Index), that can be assigned to process data.

The objects can only be accessed via the EtherCAT network.

Parameter	Name / value range / [default setting]	Info
0x1603:001	RPDO4 mapping parameter: Application object 1 • Read only	Predefined mapping entry of CiA: Controlword (0x6040) for the CiA 402 operating mode "CiA: Velocity mode" (0x60400010).
0x1603:002	RPDO4 mapping parameter: Application object 2 • Read only	Predefined mapping entry of "CiA: Target velocity" for the "Velocity Mode" (0x60420010).

Parameter	Name / value range / [default setting]	Info
0x1605:001	RPDO6 mapping parameter: Application object 1 • Read only	Mapping entry for the selection of an object to be received.
0x1605:002	RPDO6 mapping parameter: Application object 2 • Read only	
0x1605:003	RPDO6 mapping parameter: Application object 3 • Read only	
0x1605:004	RPDO6 mapping parameter: Application object 4 • Read only	
0x1605:005	RPDO6 mapping parameter: Application object 5 • Read only	
0x1605:006	RPDO6 mapping parameter: Application object 6 • Read only	
0x1605:007	RPDO6 mapping parameter: Application object 7 • Read only	
0x1605:008	RPDO6 mapping parameter: Application object 8 • Read only	
0x1605:009	RPDO6 mapping parameter: Application object 9 • Read only	
0x1605:010	RPDO6 mapping parameter: Application object 10 • Read only	
0x1605:011	RPDO6 mapping parameter: Application object 11 • Read only	
0x1605:012	RPDO6 mapping parameter: Application object 12 • Read only	
0x1605:013	RPDO6 mapping parameter: Application object 13 • Read only	
0x1605:014	RPDO6 mapping parameter: Application object 14 • Read only	
0x1605:015	RPDO6 mapping parameter: Application object 15 • Read only	
0x1605:016	RPDO6 mapping parameter: Application object 16 • Read only	
0x1A03:001	TPDO4 mapping parameter: Application object 1 • Read only	Predefined mapping entry of CiA: Statusword (0x6041 (P780.00)) for the CiA 402 operating mode "CiA: Velocity mode" (0x60410010).
0x1A03:002	TPDO4 mapping parameter: Application object 2 • Read only	Predefined mapping entry of "CiA: Velocity actual value" for the "Velocity Mode" (0x60440010).
0x1A03:003	TPDO4 mapping parameter: Application object 3 • Read only	Predefined mapping entry of "CiA: Error code" for the "Velocity Mode" (0x603F0010).



Parameter	Name / value range / [default setting]	Info
0x1A05:001	TPDO6 mapping parameter: Application object 1 • Read only	Mapping entry for the selection of an object to be sent.
0x1A05:002	TPDO6 mapping parameter: Application object 2 • Read only	
0x1A05:003	TPDO6 mapping parameter: Application object 3 • Read only	
0x1A05:004	TPDO6 mapping parameter: Application object 4 • Read only	
0x1A05:005	TPDO6 mapping parameter: Application object 5 • Read only	
0x1A05:006	TPDO6 mapping parameter: Application object 6 • Read only	
0x1A05:007	TPDO6 mapping parameter: Application object 7 • Read only	
0x1A05:008	TPDO6 mapping parameter: Application object 8 • Read only	
0x1A05:009	TPDO6 mapping parameter: Application object 9 • Read only	
0x1A05:010	TPDO6 mapping parameter: Application object 10 • Read only	
0x1A05:011	TPDO6 mapping parameter: Application object 11 • Read only	
0x1A05:012	TPDO6 mapping parameter: Application object 12 • Read only	
0x1A05:013	TPDO6 mapping parameter: Application object 13 • Read only	
0x1A05:014	TPDO6 mapping parameter: Application object 14 • Read only	
0x1A05:015	TPDO6 mapping parameter: Application object 15 • Read only	
0x1A05:016	TPDO6 mapping parameter: Application object 16 • Read only	
0x1C00:001	Sync Manager communication type: SM1 communication type • Read only	The communication type SM1 is used for the mailbox input (MbxIn).
	0 Reserved	
	1 Receive mailbox	
	2 Transmit mailbox	
	3 Transmit process data	
	4 Receive process data	
0x1C00:002	Sync Manager communication type: SM2 communication type • Read only	The communication type SM2 is used for the mailbox output (MbxOut).

Parameter	Name / value range / [default setting]	Info
0x1C00:003	Sync Manager communication type: SM3 communication type • Read only	The communication type SM3 is used for the input process data (RPDOs).
0x1C00:004	Sync Manager communication type: SM4 communication type • Read only	The communication type SM4 is used for the output process data (TPDOs).
0x1C12:000	Number of assigned PDOs • Read only	Number of selected RPDOs. These values are written by the master according to the selected setting in the master.
0x1C12:001	PDO mapping object index of 1. assigned RPDO • Read only	Indication of the 1st mapping object index.
0x1C12:002	PDO mapping object index of 2. assigned RPDO • Read only	Indication of the 2nd mapping object index.
0x1C13:000	Number of assigned PDOs • Read only	Number of selected TPDOs. These values are written by the master according to the selected setting in the master.
0x1C13:001	PDO mapping object index of 1. assigned TPDO • Read only	Display of the 1st mapping object index.
0x1C13:002	PDO mapping object index of 2. assigned TPDO • Read only	Display of the 2nd mapping object index.
0x1C32:001	Sync Manager 2: Synchronization type	Setting of the synchronisation method for the mailbox communication.
	<b>0</b> Free run	The slave application runs independently of the EtherCAT cycle time.
0x1C32:002	Sync Manager 2: Cycle time • Read only: x ns	Display of the cycle time for the mailbox communication.
0x1C32:003	Sync Manager 2: Shift time • Read only: x ns	Display of the time shift for the mailbox communication.
0x1C32:004	Sync Manager 2: Synchronization types supported • Read only	Display of the available synchronisation method for the mailbox communication. • Bit 0 (free run)
0x1C32:005	Sync Manager 2: Minimum cycle time • Read only: x ns	Display of the minimum cycle time for the mailbox communication.
0x1C33:001	Sync Manager 3: Synchronization type 0 ... [0] ... 65535	Setting of the synchronisation method for the input process data (RPDO).
0x1C33:002	Sync Manager 3: Cycle time • Read only: x ns	Display of the cycle time for the input process data (RPDO).
0x1C33:003	Sync Manager 3: Shift time • Read only: x ns	Display of the time shift for the input process data (RPDO).
0x1C33:004	Sync Manager 3: Synchronization types supported • Read only	Display of the available synchronisation method for the input process data (RPDO). • Bit 0 (free run)
0x1C33:005	Sync Manager 3: Minimum cycle time • Read only: x ns	Display of the minimum cycle time for the input process data (RPDO).

## 8.9 Parameter data transfer

- For configuring and diagnosing the EtherCAT devices, the parameters are accessed by means of acyclic communication
- Parameter data are transferred as SDOs (Service Data Objects).
- The SDO services enable the writing and reading access to parameters, EtherCAT objects and CiA 402 objects.
  - [Objects](#)
  - [Device profile CiA 402](#)
- The transfer of parameter data is usually not time-critical.
- Parameter data are, for instance, operating parameters, motor data and diagnostic information.

### SDO return values

If an SDO request is evaluated negatively, a corresponding error code is output:

Index	Description
0x00000000	No fault.
0x05030000	The state of the toggle bit has not changed.
0x05040000	SDO protocol time-out
0x05040001	Invalid or unknown specification symbol for the client/server command.
0x05040005	The space in the main memory is not sufficient.
0x06010000	Unsupported access to an object.
0x06010001	Read access to a write-only object.
0x06010002	Write access to a read-only object.
0x06020000	An object is not available in the object directory.
0x06040041	An object cannot be mapped into the PDO.
0x06040042	The number and/or length of the mapped objects would exceed the PDO length.
0x06040043	General parameter incompatibility
0x06040047	General internal incompatibility in the device.
0x06060000	The access has failed due to errors in the hardware.
0x06070010	The data type or the parameter length do not match.
0x06070012	Wrong data type: The parameter length is too big.
0x06070013	Wrong data type: The parameter length is too small.
0x06090011	A subindex is not available.
0x06090030	The value range for parameters is too big (only in case of write access).
0x06090031	The parameter value is too high.
0x06090032	The parameter value is too low.
0x06090036	The maximum value is smaller than the minimum value.
0x08000000	General fault.
0x08000020	Data cannot be transferred to the application or saved in the application.
0x08000021	Due to local control, the data cannot be transferred to the application or saved in the application.
0x08000022	Due to the current device state, the data cannot be transferred to the application or saved in the application.
0x08000023	The dynamic object directory generatio has failed or no object directory is available.

## 8.10 Short setup

During commissioning, the EtherCAT master operates as gateway to access from the Engineering PC to the slaves.

In the following, the required steps are described to control the device as EtherCAT slave.

### Precondition

- The device is networked as EtherCAT slave with an EtherCAT master and, if necessary, further EtherCAT devices (see "Typical topology").
- An Engineering PC with installed »PLC Designer« from V3.12 is connected to the master.
  - Download »PLC Designer«
- A »PLC Designer« project with current device description files for EtherCAT is available.
  - Download XML/ESI files from [www.LovatoElectric.com](http://www.LovatoElectric.com) > Downloads > Software & upgrades > Variable speed drives > Packages for VLBXSW.
- The files are installed via the device repository of the »PLC Designer« (menu command "Tools → Device repository").
- All EtherCAT devices are supplied with voltage and are switched on.

### Short setup

- With the »PLC Designer« from V3.12, the CiA 402 operating mode "CiA: Velocity mode" is automatically activated.
- In the operating mode "CiA: Velocity mode", the setpoint speed defined via the "Target velocity" [0x6042 \(P781.00\)](#) parameter is used.
- A changeover to an alternative setpoint source via CiA: Controlword ([0x6040](#)) is not possible.
- CiA: Controlword ([0x6040](#)) serves to start/stop the EtherCAT device.
- Standard configuration of the PDOs in the CiA 402 operating mode "CiA: Velocity mode":
- CiA 402 objects: ▶ [Device profile CiA 402](#)

How to configure the network:

### 1. Activate network control in the inverter.

1. Activate network control: `0x2631:037 (P400.37) = "TRUE [1]"`
2. Set network as standard setpoint source: `0x2860:001 (P201.01) = "Network [5]"`  
The network control is now activated.
3. Save parameter settings: `0x2022:003 (P700.03) = "On / start [1]"`

### 2. Configure the master for the gateway function.

1. Start the »PLC Designer«.
2. On »PLC Designer« project.
3. Open the "Communication settings" tab of the master.
4. Click "Add gateway".  
Do the following in the appearing dialog window:
  - a) Enter the IP address of the master.
  - b) Confirm the entry with "OK".
5. Click "Search network".
6. Select the corresponding master for the previously entered IP address.
7. Click "Set active path".
8. Log into the master using the "Online → Log in" menu command or with `<Alt>+<F8>`.  
Now you can access the slaves from the Engineering PC via the EtherCAT master as gateway.

### 3. Carry out network scan.

1. Execute the "Start Search" command in the context menu of the master.  
The appearing dialog box lists all available EtherCAT devices according to the physical order in the network.
2. Click "Copy all devices into the project".  
The physical network structure is reproduced in the »PLC Designer« project.



A proper operation requires that the network topology generated in the project corresponds to the physical order of the EtherCAT nodes in the network. Otherwise, an error message displays which slave (product code) is to be expected at which position.

### 4. Optionally: Adapt EtherCAT device to the application.

1. Adapt parameter values under the "Settings" and "Parameter list" tabs.
2. Set the PDO mapping under the "Process data" tab.
3. Assign variable names under the "EtherCAT I/O image" by double-clicking the variable fields.
4. Create PLC program.

### 5. Load the network configuration into the master.

1. Log off: Menu command "Online → Log off" or `<Ctrl>+<F8>`.
2. Compiling: Menu command "Build → Build" or `<F11>`.
3. Log in: Menu command "Online → Log in" or `<Alt>+<F8>`.  
The configuration, the parameter settings and the PLC program are loaded into the master. Afterwards, all EtherCAT slaves are initialised.



These steps must be carried out after every change within the »PLC Designer« project. An already available configuration and an available PLC program in the master will be then overwritten.

## 9 Modbus TCP



Modbus is an internationally approved, asynchronous, serial communication protocol, designed for commercial and industrial automation applications.

- Detailed information on the Modbus can be found on the web page of the international Modbus Organization, USA, who also further develop the Modbus protocol: <http://www.modbus.org>
- Information about the dimensioning of a Modbus network can be found in the configuration document for the inverter.

### Preconditions

The logic unit of the inverter is provided with Modbus TCP (type code VLBXL07)

### Details

- The process of data transmission distinguishes between three different operating modes: Modbus ASCII, Modbus RTU and Modbus TCP/IP. This chapter describes the Modbus TCP/IP operating mode.
- The Modbus protocol is based on a master/slave architecture where the inverter always works as slave.
- In the Modbus TCP/IP network, a master can only address one slave at a time. However, several masters can be available in the network.
- Only a master can initiate the Modbus communication.
- No direct communication takes place between the slaves.
- The network option supports the baud rates 10 Mbps (10 BaseT) and 100 Mbps (100 BaseT). The baud rate in the network is automatically detected.
- The inverter supports the function codes 3, 6, 16 (0x10) and 23 (0x17).

### Typical topologies

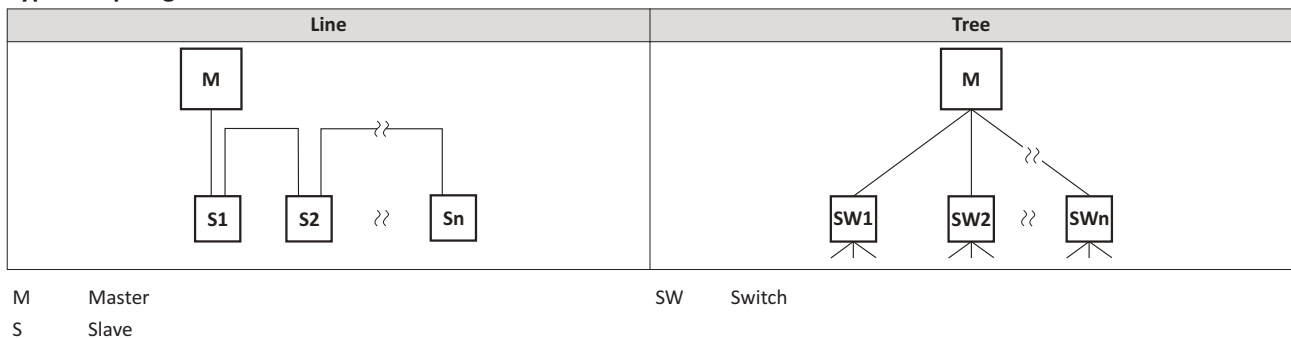

## 9.1 Commissioning

In the following, the steps required for controlling the inverter via Modbus are described.

### Parameterization required

1. Activate network control: **0x2631:037 (P400.37)** = "TRUE [1]"
2. Set network as standard setpoint source: **0x2860:001 (P201.01)** = "Network [5]"
3. Implement the IP settings of the inverter (slave).  
See chapter 9.2.1 Set IP address
4. Set Modbus baud rate.
  - Default setting: Automatic detection.
  - See chapter 9.2.2 Baud rate setting
5. Save parameter settings: **0x2022:003 (P700.03)** = "on / start [1]".
6. Switch the inverter off and then on again in order that the changed communication settings can get effective.



In the default setting, the "Run" function is assigned to digital input DI1. If network control is activated, this function serves as the "start enable" for starting commands via the network. Hence, digital input DI1 must be set to the HIGH level so the motor can be started via the network.



An internal web server is supported. It can be addressed via the IP address defined in the **0x23A1:001 (P510.01)** parameter. Protect access to the web server, e.g. with a firewall, and follow your internal IT security guidelines.



A firmware download from the PLC to the inverter via the network (also via FTP) only takes place under the following conditions:

- Required firmware version 05.01.x.x or higher
- Bootloader version 00.00.00.18 or higher

### Starting/stopping the drive via Modbus

For starting/stopping the drive, Modbus register 42101 can be used.

- The Modbus register 42101 is permanently assigned to the parameter **0x400B:001 (P592.01)** (AC Drive control word).
- In the frame, the leading 4 is omitted in the addressing process. The numbering of the registers starts with 1; addressing, however, starts with 0. Therefore the address 2100 (0x0834) is used in the frame when register 42101 is written.

Bits set in the AC Drive control word:

- Bit 0 = Run forward (CW)
- Bit 5 = Activate network control
- Bit 6 = Activate network setpoint
- Function code 6, i. e. writing into a single register.

Example of an inverter with the node address 1:

Request frame by the master					
Unit identifier	Function code	Register address		AC Drive control word Data: 0b1100001 ≙ 0x0061	
0x01	0x06	0x08	0x34	0x00	0x61

If the digital input DI1 ("Start enable") is set to HIGH level, the drive should start and the inverter should respond with the same frame as confirmation:

Response message from the inverter					
Unit identifier	Function code	Register address		AC Drive control word Data: 0b1100001 ≙ 0x0061	
0x01	0x06	0x08	0x34	0x00	0x61

## Write the speed of the drive via Modbus

The drive speed can be changed via the modbus register 42102, see chapter **9.3.2 Data mapping**.

Example of an inverter with the node address 1:

Request frame by the master					
Unit identifier	Function code	Data			
		Register address		Network setpoint frequency (0.01)	
0x01	0x06	0x08	0x35	0x04	0xD2

Response message from the inverter					
Unit identifier	Function code	Data			
		Register address		Network setpoint frequency (0.01)	
0x01	0x06	0x08	0x35	0x04	0xD2

The drive now rotates with a frequency of 12.34 Hz.

## Read the drive speed via Modbus

The drive speed can be read via the Modbus register 42002, see chapter **9.3.2 Data mapping**.

The function code 3 is used to read a single register or several interrelated register blocks, see chapter **9.3.1**

### Function codes.

Example of an inverter with the node address 1:

Request frame by the master					
Unit identifier	Function code	Data			
		Register address		Number of words	
0x01	0x03	0x07	0xD1	0x00	0x01

Response message from the inverter					
Unit identifier	Function code	Data			
		Read bytes		Frequency (0.01)	
0x01	0x03	0x02	0x04	0xD1	

The drive rotates with a frequency of 12.33 Hz.

## Restart of the communication

A restart of communication is required after changes of the interface configuration (e. g. node address and baud rate) in order that the changed settings become effective.

For restarting communication, there are two options:

- Switch inverter off and on again.
- 0x23B0 (P508.00) Set = "Restart with current values [1]".

### Parameter

Address	Name / setting range / [default setting]	Information
0x23B0 (P508.00)	Modbus TCP communication (MBTCP comm.) • From version 04.00	Restart / stop communication
	0 No action/no error	Only status feedback.
	1 Restart with current values	Restart communication in order that changed settings of the interface configuration become effective.
	2 Restart with default values	Restart communication with the standard values.
	5 Stop network communication	Stop communication.
	10 In progress	Only status feedback
	11 Action cancelled	
12 Fault		



## 9.2 Basic setting and options

### 9.2.1 IP settings

#### IP basic settings

The basic IP settings are required to let the engineering software access the network nodes (PLC, inverter) directly via Ethernet.

The PC with the engineering software must be in the same network as the devices to be configured.

First, configure the PC so that this condition is fulfilled.

The required steps are described by the example of the operating system Microsoft® Windows® 7.

How to define the IP basic settings:

1. Call the "Network and sharing center" under "Control panel".
2. Select "Change adapter settings" (observe administrator rights!).
3. Select the network to be configured (double-click), e. g.:

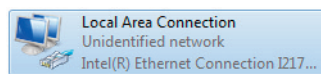

The network nodes (PLC, inverter) must be connected to the network.



An internal web server is supported. It can be addressed via the IP address defined in the parameter. Protect access to the web server, e.g. with a firewall, and follow your internal IT security guidelines.

The status dialog box of the network is opened.

4. Click "Properties".

The properties dialog box of the network is opened.

5. Select "Internet protocol version 4 (TCP/IPv4)" and click "Properties".

The properties dialog box of the "Internet protocol version 4 (TCP/IPv4)" is opened.

6. Enter the IP address, the subnet mask and, if required, the gateway address under "Use the following addresses".

7. Click "OK".

The IP basic settings are now completed.

## Set IP address

The two rotary encoder switches at the front of the device serve to set the IP address in terms of hardware.

Setting	Addressing
0x00	IP address via the parameter <b>0x23B1:001 (P510.01)</b> .
0x01 ... 0xFF	Setting of the 4th byte of the IP address via the rotary encoder switch. 192.168.124.[setting] <b>Example:</b> Setting for the value 52 $(3 \times 16) + (4 \times 1) = 52$

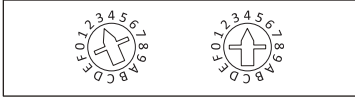

The value set via the rotary encoder switches is used when the mains is switched on or after a network restart with **0x23B0 (P508.00) = 1**. A changed value during operation will only become valid after the network has been restarted.

- **0x23B3 (P509.00)** shows the switch setting at the last mains connection.
- **0x23B2:001 (P511.01)** shows the active IP address.

## Time-To-Live (TTL)

The TTL value (8-bit value) limits the number of routers a sent package passes on the way to its target.

- **0x23A1:006 (P510.06):** Time-to-live value (TTL)

The parameters for the IP settings of the inverter are described below.

## Parameter

Address	Name / setting range / [default setting]	Information
0x23B1:001 (P510.01)	Modbus -TCP/IP settings: IP address (MBTCP settings: IP address) 0.0.0.0 ... [192.168.124.16] ... 255.255.255.255 • From version 04.00	Set IP address. The default setting 276605120 corresponds to the IP address 192.168.124.16. • $276605120 = 0x107CA8C0 \rightarrow 0xC0.0xA8.0x7C.0x10 = 192.168.124.16$
0x23B1:002 (P510.02)	Modbus -TCP/IP settings: Subnet (MBTCP settings: Subnet) 0.0.0.0 ... [255.255.255.0] ... 255.255.255.255 • From version 04.00	Set subnet mask. The default setting 16777215 corresponds to the subnet mask 255.255.255.0. • $16777215 = 0xFFFFF \rightarrow 0xFF.0xFF.0xFF.0x00 = 255.255.255.0$
0x23B1:003 (P510.03)	Modbus -TCP/IP settings: Gateway (MBTCP settings: Gateway) 0.0.0.0 ... [0.0.0.0] ... 255.255.255.255 • From version 04.00	Set gateway address. Example The setting 276344004 corresponds to the gateway address 196.172.120.16. • $276344004 = 0x1078ACC4 \rightarrow 0xC4.0xAC.0x78.0x10 = 196.172.120.16$
0x23B1:005 (P510.05)	Modbus -TCP/IP settings: IP configuration (MBTCP settings: IP configuration) • From version 04.00	Set IP configuration.
	0 Stored IP	The currently saved IP configuration is used.
	1 BOOTP	The IP configuration is assigned by the master via BOOTP.
	2 DHCP	The IP configuration is assigned by the Master via DHCP. The assignment of a gateway address that is not in the same subnetwork as the IP address, is denied.
0x23B1:006 (P510.06)	Modbus -TCP/IP settings: Time-to-live value (TTL) (MBTCP settings: TTL value) 1 ... [32] ... 255 • From version 04.00	Setting of the TTL value for the validity of data packages in the network.
0x23B1:011 (P510.11)	Modbus -TCP/IP settings: Secondary port (MBTCP settings: Secondary port) 0 ... [502] ... 65535 • From version 04.00	Set port number for a second port.

### 9.2.2 Baud rate setting

- Set the baud rate for port 1 in [0x23B4:001 \(P512.01\)](#) and for port 2 in [0x23B4:002 \(P512.02\)](#).
- The automatic detection of the baud rate is preset for the ports.
- The active baud rate is displayed for port 1 in [0x23B5:001 \(P513.01\)](#) and for port 2 in [0x23B5:002 \(P513.02\)](#).

#### Parameter

Address	Name / setting range / [default setting]	Information
0x23B4:001 (P512.01)	Port settings: Port 1 (Port settings: Port 1) • From version 04.00	
	<b>0 Auto-Negotiation</b>	
	1 10 Mbps	
	2 100 Mbps	
	5 10 Mbps/Half Duplex	
	6 10 Mbps/Full Duplex	
	7 100 Mbps/Half Duplex	
	8 100 Mbps/Full Duplex	
0x23B4:002 (P512.02)	Port settings: Port 2 (Port settings: Port 2) • From version 04.00	
	<b>0 Auto-Negotiation</b>	
	1 10 Mbps	
	2 100 Mbps	
	5 10 Mbps/Half Duplex	
	6 10 Mbps/Full Duplex	
	7 100 Mbps/Half Duplex	
	8 100 Mbps/Full Duplex	

### 9.3 Data transfer

The mode of access to inverter data (parameters) is controlled via function codes.

#### 9.3.1 Function codes

The inverter supports the following function codes:

Function code		Function name	Info
3	0x03	Read Holding Registers	Reading of a single register or a group of several interconnected registers.
6	0x06	Preset Single Register	Writing of a single register.
16	0x10	Preset Multiple Registers	Writing of a single register or a group of several interconnected registers.
23	0x17	Read/Write 4X Registers	Reading and writing within a transaction: <ul style="list-style-type: none"> <li>• Writing of a data block into a group of several interconnected registers.</li> <li>• Reading from a block of interconnected registers.</li> </ul>

#### Frame structure

Modbus Application Header (MBAP)				Protocol Data Unit (PDU)	
Transaction number	Protocol characters (always 0x0000)	Number of the bytes still to follow	Unit identifier	Function code	Data / error code
2 bytes	2 bytes	2 bytes	1 byte	1 byte	n byte

Tab. 1: ADU (Application Data Unit)

Communication is established on the basis of the master/slave mode. Communication is always started by a master request.

The inverter (slave) then either gives a valid response or outputs an error code (provided that the request has been received and evaluated as valid message).

In case of a valid answer, the function code is returned. In the event of an error, a function code assigned to the request is returned.

Error causes can be invalid CRC checksums, non-supported function codes or impermissible data accesses.

Elements of the ADU:

- MBAP (7 bytes)
  - Number of the bytes still to follow in the message.
  - Address of the inverter.
  - The other bytes of the header are not described here.
- Function code
  - The function codes exclusively refer to "4X registers", i. e. registers from the address 4000.
  - All data in the inverter can only be accessed via these 4X registers, see chapter **9.3.2 Data mapping**.
  - The 4xxx reference is implicit, i. e. given by the function code used. In the frame therefore the leading 4 is omitted in the addressing process.
  - Lovato supports the basic 1 addressing of Modbus, i.e. the numbering of the registers starts with 1 whereas addressing starts with 0. For example, the address 0 is used in the frame when register 40001 is read.
- Data or error code
- Checksum

All ADU contents are represented in the Big Endian format (most significant byte first).

## Error codes

In the event of an error, the Modbus node responds with a function code associated with the message:

Function code	Associated function code in the event of an error	Supported error codes
0x03	0x83	0x01, 0x02, 0x03, 0x04
0x06	0x86	0x01, 0x02, 0x03, 0x04
0x10	0x90	0x01, 0x02, 0x03, 0x04
0x17	0x97	0x01, 0x02, 0x03, 0x04

Error code	Designation	Cause(s)
0x01	Invalid function code	The function code is not supported by the inverter, or the inverter is in a state in which the request is not permissible or in which it cannot be processed.
0x02	Invalid data address	The combination of a start address and the length of the data to be transmitted is invalid. Example: If you have a slave with 100 registers, the first register has the address 0 and the last register has the address 99. If there is a request of four registers now, from the start address 96, the request can be processed successfully (for registers 96, 97, 98, and 99). If, however, five registers from the start address 96 are queried, this error code is returned, since the slave has no register with the address 100.
0x03	Invalid data value	Error in the reset structure of a complex request, e. g. because the data length that has resulted implicitly is not correct. The cause, however, is not that a (parameter) value is written outside the valid setting range. As a matter of principle, the Modbus protocol has no information on valid setting ranges of single registers or their meaning.
0x04	Slave device failure	A non-correctable error has occurred while the request was processed in the inverter.

## Data transfer with function code 3

Request	
Function code	0x03
Start address	0x0000 ... 0xFFFF
Number of registers (n)	0x01 ... 0x7D (1 ... 125)
Response	
Function code	0x03
Number of bytes	2 x (number of registers)
Register value	Data in (n) register of 2 bytes each
Error message	
Function code in the event of an error	0x83
Error code	01 ... 04

## Example for data transfer with function code 3

The data from the registers 40108 to 40110 are to be read.

Request		Info
Function code	0x03	Function code 3
Start address (High)	0x00	Start address 107 (0x006B)
Start address (Low)	0x6B	
Number of registers (High)	0x00	Number of registers = 3 (0x0003)
Number of registers (Low)	0x03	
Response		Info
Function code	0x03	Function code 3
Number of bytes	0x06	6 bytes are read.
Value in registers 40108 (High)	0x02	Data in register 40108: 0x022B (555).
Value in registers 40108 (Low)	0x2B	
Value in registers 40109 (High)	0x00	Data in register 40109: 0x0000 (0).
Value in registers 40109 (Low)	0x00	
Value in registers 40110 (High)	0x00	Data in register 40110: 0x0064 (100).
Value in registers 40110 (Low)	0x64	

### Data transfer with function code 6

Request	
Function code	0x06
Register address	0x0000 ... 0xFFFF
Register value	0x0000 ... 0xFFFF
Response	
Function code	0x06
Register address	0x0000 ... 0xFFFF
Register value	0x0000 ... 0xFFFF
Error message	
Function code in the event of an error	<b>0x86</b>
Error code	01 ... 04

### Example for data transfer with function code 6

The value "3" (0x0003) is to be written into the register 40002.

Request		Info
Function code	0x06	Function code 6
Register address (High)	0x00	Register address for register 40002: 1 (0x0001)
Register address (Low)	0x01	
Register value (High)	0x00	Value to be written into the register: 3 (0x0003)
Register value (Low)	0x03	
Response		Info
Function code	0x06	Function code 6
Register address (High)	0x00	Register address: 1 (0x0001)
Register address (Low)	0x01	
Register value (High)	0x00	Register value: 3 (0x0003)
Register value (Low)	0x03	

### Data transfer with function code 16

Request	
Function code	0x10
Start address	0x0000 ... 0xFFFF
Number of registers (n)	0x0001 ... 0x7D (0d125)
Number of bytes	2 x (number of registers)
Register values	Data in (n) register of 2 bytes each
Response	
Function code	0x10
Number of bytes	2 x (number of registers)
Register values	Data in (n) register of 2 bytes each
Error message	
Function code in the event of an error	<b>0x90</b>
Error code	01 ... 04

### Example for data transfer with function code 16

In a transaction, the value "10" is to be written into the register 40002 and the value "258" is to be written into the adjacent register 40003.

Request		Info
Function code	0x10	Function code 16
Start address (High)	0x00	Start address is the register 40002: 1 (0x0001)
Start address (Low)	0x01	
Number of registers (High)	0x00	Number of registers: 2 (0x0002)
Number of registers (Low)	0x02	
Number of bytes	0x04	4 bytes (0x0004) are to be written.
Register value (High)	0x00	The value "10" (0x000A) is written into the register with the start address 1 (= register 40002).
Register value (Low)	0x0A	
Register value (High)	0x01	The value "258" (0x0102) is written into the following register (= register 40003).
Register value (Low)	0x02	

Response		Info
Function code	0x10	Function code 16
Start address (High)	0x00	Start address: 1 (0x0001)
Start address (Low)	0x01	
Number of registers (High)	0x00	Number of registers: 2 (0x0002)
Number of registers (Low)	0x02	

### Data transfer with function code 23

Request	
Function code	<b>0x17</b>
Start address for reading (High)	0x0000 ... 0xFFFF
Start address for reading (Low)	0x0000 ... 0xFFFF
Number of registers for reading (High)	0x00 ... 0xFF
Number of registers for reading (Low)	0x00 ... 0xFF
Start address for writing (High)	0x0000 ... 0xFFFF
Start address for writing (Low)	0x0000 ... 0xFFFF
Number of registers for writing (High)	0x00 ... 0xFF
Number of registers for writing (Low)	0x00 ... 0xFF
Number of bytes for writing	2 x (number of registers)
Written value 1 (High)	0x00 ... 0xFF
Written value 1 (Low)	0x00 ... 0xFF
....	...
Written value n (High)	0x00 ... 0xFF
Written value n (Low)	0x00 ... 0xFF

Response	
Function code	<b>0x17</b>
Number of bytes for reading	2 x (number of registers)
Read value 1 (High)	0x00 ... 0xFF
Read value 1 (Low)	0x00 ... 0xFF
...	...
Read value x (High)	0x00 ... 0xFF
Read value x (Low)	0x00 ... 0xFF

Error message	
Function code in the event of an error	<b>0x97</b>
Error code	02 ... 04

### Example for data transfer with function code 23

The following tasks are to be executed with a transaction:

- The values from six connected registers, starting with register 40005, are to be read.
- The value "255" is to be written into each of three connected registers, starting with register 40016.

Request		Info
Function code	0x17	Function code 23
Start address for reading (High)	0x00	Start address for reading is the register 40005: 4 (0x0004)
Start address for reading (Low)	0x04	
Number of registers for reading (High)	0x00	Number of registers for reading: 6 (0x0006)
Number of registers for reading (Low)	0x06	
Start address for writing (High)	0x00	Start address for writing is the register 40016: 15 (0x000F)
Start address for writing (Low)	0x0F	
Number of registers for writing (High)	0x00	Number of registers for writing: 3 (0x0003)
Number of registers for writing (Low)	0x03	
Number of bytes for writing	0x06	6 bytes (0x06) must be provided in 3 registers.
Written value 1 (High)	0x00	Data: 255 (0x00FF)
Written value 1 (Low)	0xFF	
Written value 2 (High)	0x00	Data: 255 (0x00FF)
Written value 2 (Low)	0xFF	
Written value 3 (High)	0x00	Data: 255 (0x00FF)
Written value 3 (Low)	0xFF	

Response		Info
Function code	0x17	Function code 23
Number of bytes for reading	0x0C	12 bytes (0x0C) from 6 registers are read.
Read value 1 (High)	0x00	1. written value Data: 254 (0x00FE)
Read value 1 (Low)	0xFE	
Written value 2 (High)	0x0A	2. written value Data: 2765 (0x0ACD)
Read value 2 (Low)	0xCD	
Read value 3 (High)	0x00	3. read value Data: 1 (0x0001)
Read value 3 (Low)	0x01	
Read value 4 (High)	0x00	4. read value Data: 3 (0x0003)
Read value 4 (Low)	0x03	
Read value 5 (High)	0x00	5. read value Data: 13 (0x000D)
Read value 5 (Low)	0x0D	
Read value 6 (High)	0x00	6. read value Data: 255 (0x00FF)
Read value 6 (Low)	0xFF	



### 9.3.2 Data mapping

The process of data mapping is used for defining which Modbus registers read or write to which inverter parameters.

- There are pre-defined Modbus registers for common control and status words, which are located in coherent blocks, in order to facilitate communication with OPC servers and other Modbus masters. In order to access all relevant data of the inverter, only a minimum number of commands is required.
- In addition, 24 registers are provided for variable mapping, i. e. free assignment to inverter parameters.

#### Overview

The following table provides an overview of the Modbus register with variable and permanent assignment:

Register	Register address	Info
40103	0102	Variable mapping <a href="#">0x23BB:001 ... 0x23BB:024 (P530.01 ... 24)</a> serves to map these 24 registers to parameters of the inverter.
40104	0103	
...	...	
40149	0148	
42001	2000	Predefined Modbus status registers For details see the following section "Predefined Modbus status registers".
...	...	
42021	2020	
42101	2100	Predefined Modbus control registers For details see the following section "Predefined Modbus control registers".
...	...	
42121	2120	

#### Predefined Modbus control registers

- These registers are provided with write and read access.
- The cross-reference in column 2 leads to the detailed parameter description.

Modbus registers	Permanently assigned parameter	
	Address	Designation
42101	<a href="#">0x400B:001 (P592.01)</a>	AC Drive control word
42102	<a href="#">0x400B:005 (P592.05)</a>	Network setpoint frequency (0.01)
42103	<a href="#">0x4008:002 (P590.02)</a>	NetWordIN2
42104	<a href="#">0x4008:003 (P590.03)</a>	NetWordIN3
42105	<a href="#">0x400B:007 (P592.07)</a>	PID setpoint
42106	<a href="#">0x6071</a>	Set torque
42107	<a href="#">0x4008:001 (P590.01)</a>	NetWordIN1
42108	<a href="#">0x4008:004 (P590.04)</a>	NetWordIN4
42109 ... 42121	-	Reserved

### Predefined Modbus status registers

- These registers are only provided with read access.
- The cross-reference in column 2 leads to the detailed parameter description.

Modbus registers	Permanently assigned parameter	
	Address	Designation
42001	<a href="#">0x400C:001 (P593.01)</a>	AC Drive status word
42002	<a href="#">0x400C:006 (P593.06)</a>	Frequency (0.01)
42003	<a href="#">0x603F (P150.00)</a>	Error code
42004	<a href="#">0x400C:005 (P593.05)</a>	Drive status
42005	<a href="#">0x2D89 (P106.00)</a>	Motor voltage
42006	<a href="#">0x2D88 (P104.00)</a>	Motor current
42007	<a href="#">0x6078 (P103.00)</a>	Actual current
42008	<a href="#">0x2DA2:002 (P108.02)</a>	Apparent power (42008 = High Word, 42009 = Low Word)
42009		
42010	<a href="#">0x2D84:001 (P117.01)</a>	Heatsink temperature
42011	<a href="#">0x2D87 (P105.00)</a>	DC-bus voltage
42012	<a href="#">0x60FD (P118.00)</a>	Digital input status (only bit 16 ... bit 31)
42013	<a href="#">0x6077 (P107.00)</a>	Actual torque
42014 ... 42021	-	Reserved

### Variable mapping

- Via [0x23BB:001 ... 0x23BB:024 \(P530.01 ... 24\)](#), 24 registers can be mapped to parameters of the inverter. Format:  
0xiiii00  
(iiii = index,  
ss = subindex)
- The display of the internal Modbus register numbers in [0x23BC:001 ... 0x23BC:024 \(P531.01 ... 24\)](#) is generated automatically. Since 32-bit parameters require two registers, there is no 1:1 assignment.
- For the mappable registers, a CRC (Cyclic Redundancy Check) is executed. The checksum determined is displayed in [0x23BD \(P532.00\)](#). The user can read this "validation code" and use it for comparison in the Modbus master. In this way it can be checked whether the inverter currently queried is configured correctly for the respective application.

### Parameter

Address	Name / setting range / [default setting]	Information
0x23BB:001 ... 0x23BB:024 (P530.01 ... 24)	Modbus TCP/IP parameter mapping: Parameter 1 ... Parameter 24 (MBTCP param.mapp: Parameter 1 ... Parameter 24) 0x00000000 ... [ <a href="#">0x00000000</a> ] ... 0xFFFFFFFF	Mapping entries for the variable mapped Modbus registers. • Format: 0xiiii00 (iiii = index, ss = subindex)
0x23BC:001 ... 0x23BC:024 (P531.01 ... 24)	Register assignment: Register 1 ... Register 24 (Register assignm: Register 1 ... Register 24) • Read only	Display of the internal Modbus register number starting from which the parameter mapped in <a href="#">0x23BB:001 ... 0x23BB:024 (P530.01 ... 24)</a> is stored. • For the first parameter mapped, always 2500. • From the second parameter mapped, 2500 + offset. The offset results from the data types of the previously mapped parameters.
0x23BD (P532.00)	Verification code (Verificat. code) • Read only • From version 04.00	

## 9.4 Monitoring

The parameters for setting network monitoring functions are described below.

### Parameter

Address	Name / setting range / [default setting]	Information
0x23B1:010 (P510.10)	Modbus -TCP/IP settings: Ethernet time-out (MBTCP settings: Ethernet timeout) 0 ... <b>[10]</b> ... 65535 s • From version 04.00	Setting of the maximum permissible time-out of the TCP communication. When the specified monitoring time has elapsed, the response set in <a href="#">0x2859:007 (P515.07)</a> is triggered in the inverter.
0x23B6:001 (P514.01)	Time-out monitoring: Time-out time (MBTCP t-out mon: Time-out time) 0.0 ... <b>[2.0]</b> ... 300.0 s • From version 04.00	Monitoring is active if the first valid write command arrives at the Modbus master. Each further valid write/read message resets the watchdog timer. Monitoring responds if within the time set here no valid message has been received by the Modbus master.
0x23B6:002 (P514.02)	Time-out monitoring: Keep alive time-out time (MBTCP t-out mon: Keep al t-out) 0.0 ... <b>[2.0]</b> ... 300.0 s • From version 04.00	Monitoring is active after a valid value is written into the keep alive register <a href="#">0x23B6:005 (P514.05)</a> via the Modbus for the first time. Keep alive monitoring responds if no value (range 1 ... 65535) has been written into the keep alive register within the time set here.
0x23B6:005 (P514.05)	Time-out monitoring: Keep alive register (MBTCP t-out mon: Keep al register) 0 ... <b>[0]</b> ... 65535 • From version 04.00	Time-out monitoring of the keep alive register is active after a value has been written into the keep alive register for the first time. In order to prevent that time-out monitoring for the keep alive register responds, the keep alive register must be written as follows: • With a value of 1 ... 65535 <b>and</b> • an interval that is shorter than the time set in <a href="#">0x23B6:002 (P514.02)</a> .
0x2859:003 (P515.03)	Modbus TCP/IP monitoring: Configuration error (MBTCP monitoring: Config error) • From version 04.00	Selection of the response triggered by the reception of invalid configuration data. Associated error code: • <a href="#">33414</a>   <a href="#">0x8286</a> - Network - PDO mapping error
	0 No response	
	1 Warning	
	2 <b>Trouble</b>	
0x2859:004 (P515.04)	Modbus TCP/IP monitoring: Initialisation error (MBTCP monitoring: Init error) • From version 04.00	Selection of the response triggered by the occurrence of an error during the initialisation of the network component. Associated error code: • <a href="#">33170</a>   <a href="#">0x8192</a> - Network - Initialization error
	0 No response	
	1 Warning	
	2 <b>Trouble</b>	
0x2859:007 (P515.07)	Modbus TCP/IP monitoring: Fault response to network timeout (MBTCP monitoring: React t-out netw) • From version 04.00	If monitoring detects a time-out of the TCP communication with an existing TCP connection, the error response to be selected with this parameter occurs. The maximum permissible time-out of the TCP communication is defined in <a href="#">0x23B1:010 (P510.10)</a> . Associated error code: • <a href="#">33044</a>   <a href="#">0x8114</a> - Network - Overall communication time-out
	0 No response	
	1 <b>Warning</b>	
	2 Trouble	
0x2859:008 (P515.08)	Modbus TCP/IP monitoring: Fault response to master timeout (MBTCP monitoring: React t-out mast) • From version 04.00	Selection of the response if within the time set in <a href="#">0x23B6:001 (P514.01)</a> no valid message has arrived at the Modbus master. Associated error code: • <a href="#">33046</a>   <a href="#">0x8116</a> - Modbus TCP master time-out
	0 No response	
	1 Warning	
	2 Trouble	
	3 <b>Fault</b>	





Address	Name / setting range / [default setting]	Information
0x2859:009 (P515.09)	Modbus TCP/IP monitoring: Fault response to keep alive timeout (MBTCP monitoring: Reac t-out kp-al) • From version 04.00	Selection of the response if within the time set in <a href="#">0x23B6:002 (P514.02)</a> no valid message has been written into the keep alive register. Associated error code: • <a href="#">33047</a>   <a href="#">0x8117</a> - Modbus TCP Keep Alive time-out
	0 No response	
	1 Warning	
	2 Trouble	
	<b>3 Fault</b>	

## 9.5 Diagnostics





### 9.5.1 LED status display

Information on the CIP status can be obtained quickly via the "MS" and "NS" LED displays on the front of the inverter. In addition, the LEDs at the RJ45 sockets indicate the connection status.

The "MS" LED indicate the CIP module status.

LED "MS" (green/red)	CIP module status	Status/meaning
off	Nonexistent	The network option is not supplied with voltage.
 On (green)	Operational	The network option works correctly.
 Blinking green	Standby	The network option is not configured completely or the configuration is incorrect.
 Blinking red	Major recoverable fault	The network option contains a correctable error.
 on (red)	Major unrecoverable fault	The network option contains a non-correctable error.
 Blinking green/red	Device self testing	The network option executes a self-test.

The "NS" LED indicate the CIP network status.

LED "NS" (green/red)	CIP network status	Status/meaning
off	No IP address	The network option is not supplied with voltage or has not received an IP address yet.
 On (green)	Connected	The network option works correctly an has established a connection to the master.
 Blinking green	No connections	The network option <ul style="list-style-type: none"> <li>works correctly,</li> <li>has been assigned to an IP address,</li> <li>has not been implemented into the network yet by the master.</li> </ul>
 Blinking red	Connection timeout	A time-out has occurred.
 on (red)	Duplicate IP	The network option cannot access the network (IP address conflict).
 Blinking green/red	Device self testing	The network option executes a self-test.

### Status displays at the RJ45 sockets

The LEDs at the RJ45 sockets indicate the connection status to the network:

LED "Link" (green)	Status/meaning
off	No connection to the network.
 on	A physical connection to the network is available.

LED "Activity" (yellow)	Status/meaning
off	No data transfer.
 on or flickers	Data is exchanged via the network.

### 9.5.2 Information on the network

The following parameters serve to diagnose the communication activities between the inverter and the Modbus network.

The following parameters show information on the network.

#### Parameter

Address	Name / setting range / [default setting]	Information
0x23B2:001 (P511.01)	Active Modbus TCP settings: Active IP address (Act. MBTCP sett.: Act. IP address) <ul style="list-style-type: none"> <li>Read only</li> <li>From version 04.00</li> </ul>	Display of the active IP address.

Address	Name / setting range / [default setting]	Information
0x23B2:002 (P511.02)	Active Modbus TCP settings: Active subnet (Act. MBTCP sett.: Act. subnet) • Read only • From version 04.00	Display of the active subnet mask.
0x23B2:003 (P511.03)	Active Modbus TCP settings: Active gateway (Act. MBTCP sett.: Act. gateway) • Read only • From version 04.00	Display of the active gateway address. Example The setting 276344004 corresponds to the gateway address 196.172.120.16. • 276344004 = 0x1078ACC4 → 0xC4.0xAC.0x78.0x10 = 196.172.120.16
0x23B2:005 (P511.05)	Active Modbus TCP settings: MAC address (Act. MBTCP sett.: MAC address) • Read only • From version 04.00	Display of the active MAC address.
0x23B3 (P509.00)	Switch position (Switch position) • Read only • From version 04.00	Display of the rotary encoder switch setting at the last mains power-on.
0x23B5:001 (P513.01)	Active port settings: Port 1 (Act. port sett.: Port 1) • Read only • From version 04.00 0 Not connected 1 10 Mbps/Half Duplex 2 10 Mbps/Full Duplex 3 100 Mbps/Half Duplex 4 100 Mbps/Full Duplex	Display of the baud rate set for Port 1 in <a href="#">0x23B4:001 (P512.01)</a> .
0x23B5:002 (P513.02)	Active port settings: Port 2 (Act. port sett.: Port 2) • Read only • From version 04.00 0 Not connected 1 10 Mbps/Half Duplex 2 10 Mbps/Full Duplex 3 100 Mbps/Half Duplex 4 100 Mbps/Full Duplex	Display of the baud rate set for Port 2 in <a href="#">0x23B4:001 (P512.01)</a> .
0x23B8 (P516.00)	Modbus TCP module status (MBTCP modul. stat) • Read only • From version 04.00 0 Power off 1 Initialization 2 Warning 3 Fault 4 No configuration 5 Operational	Display of the TCP module state.
0x23B9 (P517.00)	Modbus TCP/IP network status (MBTCP netw stat) • Read only • From version 04.00 0 No configuration 1 Initialization 2 Connection time-out 3 Configuration error 4 Not connected 5 Connection established	Display of the active network status.
0x23BA:001 (P580.01)	Modbus TCP statistics: Messages received (MBTCP statistics: Rx messages) • Read only • From version 04.00	Display of the total number of messages received. • This counter counts both valid and invalid messages. • After the maximum value has been reached, the counter starts again "0".

Address	Name / setting range / [default setting]	Information
0x23BA:002 (P580.02)	Modbus TCP statistics: Valid messages received (MBTCP statistics: Valid Rx messag.) • Read only • From version 04.00	Display of the number of valid messages received. • After the maximum value has been reached, the counter starts again "0".
0x23BA:003 (P580.03)	Modbus TCP statistics: Messages with exceptions (MBTCP statistics: Mess. w. except) • Read only • From version 04.00	Display of the number of messages with exceptions that have been received. • After the maximum value has been reached, the counter starts again "0".
0x23BA:005 (P580.05)	Modbus TCP statistics: Messages sent (MBTCP statistics: Tx messages) • Read only • From version 04.00	Display of the total number of messages sent. • After the maximum value has been reached, the counter starts again "0".
0x23BE:001 (P585.01)	Modbus TCP/IP diagnostics of last Rx/Tx data: Receive offset (MBTCP Tx/Rx diag: Rx offset) 0 ... [0] ... 240 • From version 04.00	For diagnostic purposes, the last received message (max. 16 bytes) is displayed in <b>0x23BE:002 (P585.02)</b> . For longer messages, an offset can be specified here, indicating from which byte of the message the display of the 16 bytes is to start.
0x23BE:002 (P585.02)	Modbus TCP/IP diagnostics of last Rx/Tx data: Last Rx message (MBTCP Tx/Rx diag: Last Rx message) • Read only • From version 04.00	Display of the message received last.
0x23BE:003 (P585.03)	Modbus TCP/IP diagnostics of last Rx/Tx data: Transmit offset (MBTCP Tx/Rx diag: Tx offset) 0 ... [0] ... 240 • From version 04.00	For diagnostic purposes, the last sent message (max. 16 bytes) is displayed in <b>0x23BE:004 (P585.04)</b> . For longer messages, an offset can be specified here, indicating from which byte of the message the display of the 16 bytes is to start.
0x23BE:004 (P585.04)	Modbus TCP/IP diagnostics of last Rx/Tx data: Last Tx message (MBTCP Tx/Rx diag: Last Tx message) • Read only • From version 04.00	Display of the message sent last.