



- Signal towers ready assembled Ø45mm/1.77" 8LT4... series Steady light and pulsed or continuous sound modules
- Signal towers Ø50mm/1.97" and Ø70mm/2.75" LTN... series Modular and combinations up to 5 modules; steady or blinking light
- Multicoloured signal towers Ø70mm/2.75" 8LT73... type Modular and combinations up to 5 modules; steady light and pulsed or continuous sound modules
- Signal towers Ø70mm/2.75" 8LT7... series Modular and combinations up to 7 modules; steady or blinking light, pulsed or continuous sound modules
- Signal beacons Ø62mm/2.44" 8LB... series Steady or blinking light, pulsed or continuous sound modules.

Signal towers and beacons

Signal towers ready assembled Ø45mm/1.77" 8LT4... series	9 - 2
Signal towers Ø50mm/1.97" LTN... series	9 - 3
Signal towers Ø70mm/2.75" LTN... series	9 - 4
Multicoloured signal towers Ø70mm/2.75" 8LT73... type	9 - 5
Signal towers Ø70mm/2.75" 8LT7... series	9 - 6
Signal beacons Ø62mm/2.44" 8LB... series	9 - 8

Dimensions	9 - 12
------------------	--------

Wiring diagrams	9 - 17
-----------------------	--------

Visual code	Red	Yellow	Orange	Blue	Green	White
Meaning	Danger. Emergency.	Warning and caution. Abnormal situation.	Mandatory command.	Normal situation. Regular operation.	No specific meaning.	
Sound	Fast modulated repetition or high-pitch pulsing.	Continuous short sound.	Alternating sound at constant tone.	Constant and prolonged sound after an alarm.	Other sounds.	
Correlated actions	Immediate intervention to deal with dangerous situation.	Control intervention required.	Intervention needed for mandatory action.	No specific action.	Depending on the situation.	

Interpretation of light and sound signals for signal towers and beacons

Light and sound signals are a fundamental element for the safety of a system.

To avoid incorrect interpretations, a European standard has been introduced attributing an unambiguous meaning to visual or audible signals.

Each colour or sound alarm corresponds to a specific state of operation of the connected system and various levels of warning, as shown in the table above, according to EN 981-IEC/EN/BS 60073 standards. The white module can be assigned a meaning as desired.



Page 9-2

SIGNAL TOWERS READY ASSEMBLED Ø45mm/1.77" 8LT4... SERIES

- Signal towers supplied already assembled Ø45mm/1.77"
- Steady light modules
- Pulsed or continuous sound modules
- Built-in LED circuit.



Page 9-3

SIGNAL TOWERS Ø50mm/1.97" LTN... SERIES

- Modular signal towers supplied Ø50mm/1.97"
- Steady light or blinking modules
- Continuous sound modules
- Built-in LED bulb.



Page 9-4

SIGNAL TOWERS Ø70mm/2.75" LTN... SERIES

- Modular signal towers supplied Ø70mm/2.75"
- Steady light or blinking modules
- Continuous sound modules
- Built-in LED bulb.



Page 9-5

MULTICOLOURED SIGNAL TOWERS Ø70mm/2.75" 8LT73... TYPE

- Modular signal towers Ø70mm/2.75"
- Steady light multicoloured modules
- Pulsed or continuous sound multicoloured modules
- Built-in LED circuit.

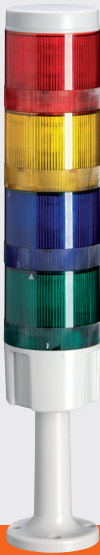

Page 9-6 and 7

SIGNAL TOWERS Ø70mm/2.75" 8LT7... SERIES

- Modular signal towers supplied Ø70mm/2.75"
- Steady light modules
- Pulsed or continuous sound modules
- Incandescent and LED bulbs.



Page 9-8

SIGNAL BEACONS Ø62mm/2.44"

- Modular signal beacons Ø62mm/2.44"
- Steady light or blinking modules
- Pulsed or continuous sound multicoloured modules
- Incandescent and LED bulbs.

Signal towers ready assembled Ø45mm/1.77", 8LT4... series



8LT4K02BG



8LT4K05BG



8LT4K09BG

Order	Description	Qty per pkg	Wt
		n°	[kg]
Steady light and pulsed or continuous sound light modules. Built-in LED circuit ①.			
8LT4K02BG	Green, red, 24VDC	1	0.160
8LT4K03BG	Green, red with continuous or pulsed sound, 24VDC	1	0.240
8LT4K04BG	Green, orange, red, 24VDC	1	0.240
8LT4K05BG	Green, orange, red with continuous or pulsed sound, 24VDC	1	0.320
8LT4K06BG	Green, blue, orange, red, 24VDC	1	0.320
8LT4K07BG	Green, blue, orange, red, with continuous or pulsed sound, 24VDC	1	0.400
8LT4K08BG	White, green, blue, orange, red, 24VDC	1	0.400
8LT4K09BG	White, green, blue, orange, red, with continuous or pulsed sound, 24VDC	1	0.480

① For accessories and spare parts see page 9-9 and 10.

General characteristics

The Ø45mm/1.77" signal towers are supplied completely assembled with the possibility of up to 3 light modules with a sound module. The high-brightness LED circuit lighting ensures low consumption and long life.

Technical characteristics

- Supply voltage: 24VDC (±10%)
- Light module consumption: 37mA per module
- Sound module consumption: 15mA
- Sound intensity: 80dB/1m, pulsed or continuous sound
- Material: polycarbonate
- Connections: screw clamp terminals and maximum conductor section 1.5mm²/16AWG
- Tightening torque: 0.5Nm/4.5lb.in
- Operating temperature: -20...+50°C
- IEC degree of protection: IP54.

Certifications and compliance

Certifications obtained: cULus, EAC.
Compliant with standards: IEC/EN/BS 60947-5-1, IEC/EN/BS 60947-1, UL508, CSA C22.2 n° 14.

Combinations

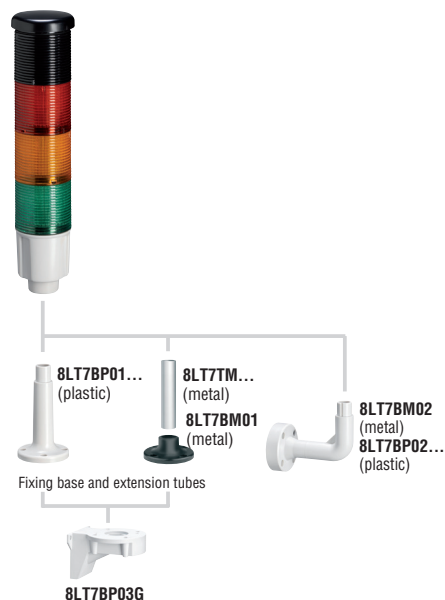

For accessories and spare parts see page 9-9 and 10.

Signal towers Ø50mm/1.97" LTN... series



LTN50ML1



LTN50MSH



LTN50MSL



LTN50C



LTN50MW024



LTN50MWB024



LTN50BP1



LTN50BM1



LTN50BP2



LTN50BM2



LTN50BP3



LTN50BM3



LTN50P100



LTN50P050



LTN50P100T



LTN50P050T

Order code	Description	Qty per pkg	Wt.
		n°	[kg]

Blinking or steady light modules.
Integrated LED lamp.

LTN50ML1	Orange	1	0.037
LTN50ML3	Green	1	0.037
LTN50ML4	Red	1	0.037
LTN50ML6	Blue	1	0.037
LTN50ML8	White	1	0.037

Continuous sound modules.

LTN50MSL	85dB/1m. IP65, Type 4	1	0.050
LTN50MSH	100dB/1m. IP20	1	0.048

Wiring modules.

LTN50MW024	12...24VDC tube mounting	1	0.136
LTN50MW230	110...230VAC tube mounting	1	0.222
LTN50MWB024	12...24VDC screw mounting	1	0.098
LTN50MWB230	110...230VAC screw mounting	1	0.237

Top cover.

LTN50C	To be used only if sound module is not present	5	0.010
--------	--	---	-------

Fixing bases.

LTN50BP1	Horizontal surface mounting, grey plastic	1	0.032
LTN50BP2	Wall mounting, grey plastic	1	0.046
LTN50BP3	Horizontal surface or wall mounting, grey plastic	1	0.076
LTN50BM1	Horizontal surface mounting, metal	1	0.072
LTN50BM2	Wall mounting, metal	1	0.088
LTN50BM3	Horizontal surface or wall mounting, metal	1	0.173

Extension tubes with threaded end.

LTN50P050T	50mm/1.97", metal	5	0.014
LTN50P100T	100mm/3.94", metal	5	0.027
LTN50P250T	250mm/9.84", metal	5	0.066
LTN50P400T	400mm/15.75", metal	5	0.108

Extension tubes for LTN50BP2.

LTN50P050	50mm/1.97", metal	5	0.014
LTN50P100	100mm/3.94", metal	5	0.028
LTN50P250	250mm/9.84", metal	5	0.068
LTN50P400	400mm/15.75", metal	5	0.109

① For light towers including both white light module and sound modules please check the wiring diagram at page 9-17.

② For fixing base LTN50BP2 the extension tube LTNP... without threaded end has to be used.

General characteristics

Signal towers are fundamental elements in manufacturing processes for the visual and audible signaling of the system status.

The signal towers can be assembled by stacking up to 5 light modules or 4 light modules and 1 sound module.

Technical characteristics

- maximum operational voltage: 26.4VDC - 240VAC
- light, sound and wiring modules consumption:
 - light modules: 1.2VA
 - sound modules: 1.7VA
 - wiring modules: 1VA
- number of stackable modules: 5
- connections: screw clamp terminals and conductor section 0.25...1.5mm²/AWG16...24
- operating temperature: -30...+50°C
- IEC degree of protection: IP65 for wiring modules, light modules, top cover and sound module LTN50MSL.

Certifications and compliance

Certifications obtained: cULus, EAC.
Compliant with standards: IEC/EN/BS 60947-5-1, IEC/EN/BS 60947-1, UL508, CSA C22.2 n° 14.

Combinations

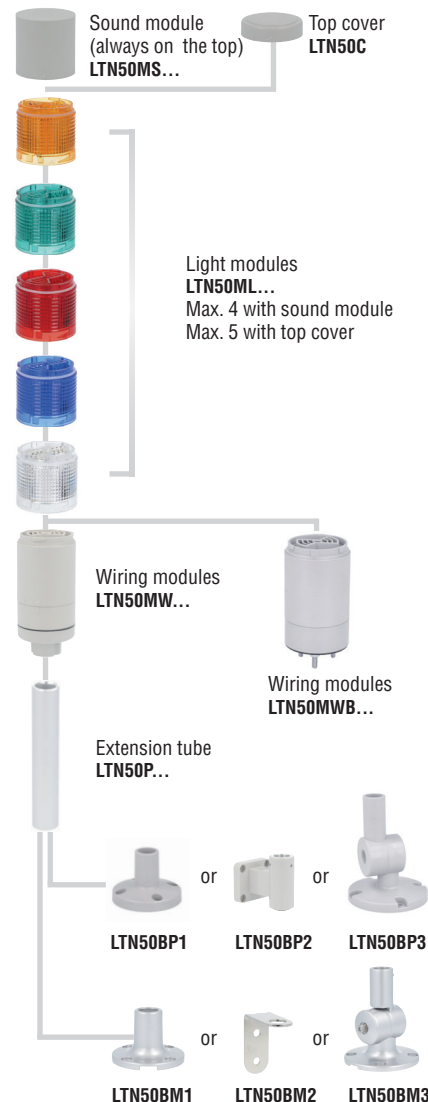

Signal towers Ø70mm/2.75" LTN... series



LTN70ML3



LTN70MSH



LTN70MSL



LTN70C



LTN70MW024



LTN70MWB024



LTN70BP1



LTN70BM1



LTN70BP2



LTN70BM2



LTN70BP3



LTN70BM3



LTN70P100



LTN70P050



LTN70P100T



LTN70P050T

Order code	Description	Qty per pkg	Wt.
		n°	[kg]

Blinking or steady light modules.
Integrated LED lamp.

LTN70ML1	Orange	1	0.066
LTN70ML3	Green	1	0.066
LTN70ML4	Red	1	0.066
LTN70ML6	Blue	1	0.066
LTN70ML8 ^①	White	1	0.066

Continuous sound modules^②.

LTN70MSL	85dB/1m. IP65, Type 4	1	0.065
LTN70MSH	100dB/1m. IP20	1	0.062

Wiring modules.

LTN70MW024	12...24VDC tube mounting	1	0.170
LTN70MW230	110...230VAC tube mounting	1	0.277
LTN70MWB024	12...24VDC screw mounting	1	0.170
LTN70MWB230	110...230VAC screw mounting	1	0.277

Top cover.

LTN70C	To be used only if sound module is not present	5	0.014
--------	--	---	-------

Fixing bases.

LTN70BP1	Horizontal surface, mounting, grey plastic	1	0.040
LTN70BP2 ^②	Horizontal surface mounting, grey plastic	1	0.067
LTN70BP3	Horizontal surface or wall mounting, grey plastic	1	0.094
LTN70BM1	Horizontal surface mounting, metal	1	0.101
LTN70BM2	Wall mounting, metal	1	0.131
LTN70BM3	Horizontal surface or wall mounting, metal	1	0.242

Extension tubes with threaded end.

LTN70P050T	50mm/1.97", metal	5	0.022
LTN70P100T	100mm/3.94", metal	5	0.039
LTN70P250T	250mm/9.84, metal	5	0.100
LTN70P400T	400mm/15.75", metal	5	0.163

Extension tubes for LTN70BP2.

LTN70P050	50mm/1.97", metal	5	0.022
LTN70P100	100mm/3.94", metal	5	0.043
LTN70P250	250mm/9.84, metal	5	0.105
LTN70P400	400mm/15.75", metal	5	0.167

^① For light towers including both white light module and sound modules please check the wiring diagram at page 9-17.

^② For fixing base LTN70BP2 the extension tube LTNP... without threaded end has to be used.

^③ Extension tubes with threaded end LTNP...T have to be used for all the fixing bases except for LTN70BP2.

General characteristics

The signal towers can be assembled by stacking up to 5 light modules or 4 light modules and 1 sound module.

Technical characteristics

- maximum operational voltage: 26.4VDC - 240VAC
- light, sound and wiring modules consumption:
 - light modules: 1.2VA
 - sound modules: 1.7VA
 - wiring modules: 1VA
- number of stackable modules: 5
- connections: screw clamp terminals and conductor section 0.25...1.5mm²/AWG16...24
- operating temperature: -30...+50°C
- IEC degree of protection: IP65 for wiring modules, light modules, top cover and sound module LTN70MSL.

Certifications and compliance

Certifications obtained: cULus, EAC.
Compliant with standards: IEC/EN/BS 60947-5-1, IEC/EN/BS 60947-1, UL508, CSA C22.2 n° 14.

Combinations

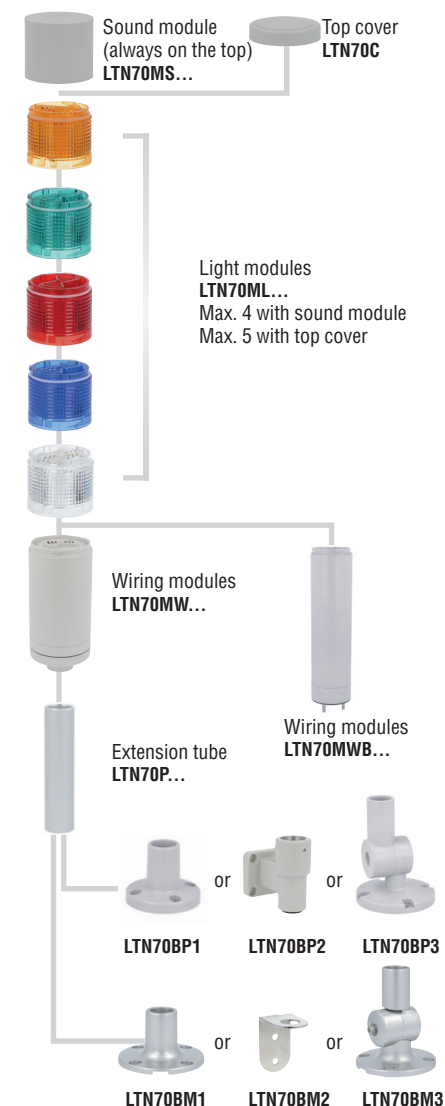

Multicoloured signal towers Ø70mm/2.75" 8LT73... type



8LT73S...



8LT73B...

Order code	Description	Qty per pkg	Wt. [kg]
		n°	
Steady light and pulsed or continuous sound multicoloured light modules. Built-in LED circuit ❶.			
8LT73B9A	Green, orange, red, 24VDC	1	0.090
8LT73S2B9A	Green, orange, red, with continuous or pulsed sound 24VDC	1	0.200
8LT73B9B	Blue, orange, red, 24VDC	1	0.090
8LT73S2B9B	Blue, orange, red, with continuous or pulsed sound 24VDC	1	0.200

❶ For accessories and spare parts see page 9-9 and 10.

General characteristics

The multicoloured signal towers incorporate the possibility of up to 3 different colours in a single light module. In the event of two or more alarms, the multicoloured module lights up in alternating colours corresponding to the event. The multicoloured module must always be placed last, at the top of the tower, should it be used together with light modules 8LT7EL... 8LT7GL... or 8LT7FL....

Technical characteristics

- Supply voltage: 24VDC (±10%)
- Light and sound module consumption: 90mA
- Sound intensity: 90dB/1m
- Material: polycarbonate
- Number of stackable elements: 4 with 8LT73B modules, 1 with 8LT73S modules
- Connections: screw clamp terminals and maximum conductor section 1.5mm²/16AWG
- Tightening torque: 0.5Nm/4.5lb.in
- Operating temperature: -20...+50 °C
- IEC degree of protection: IP65.

Certifications and compliance

Certifications obtained: cULus, EAC.
Compliant with standards: IEC/EN/BS 60947-5-1, IEC/EN/BS 60947-1, UL508, CSA C22.2 n° 14.

Combinations

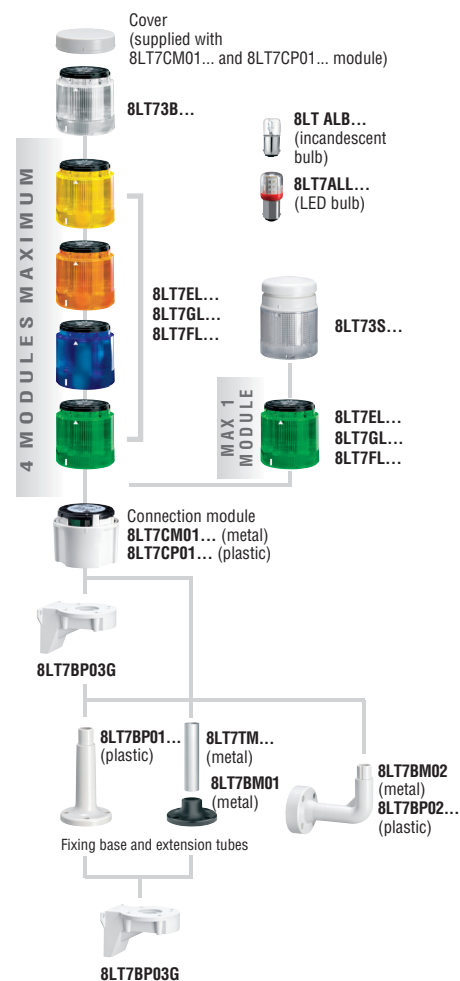

For accessories and spare parts see page 9-9 and 10.

Signal towers Ø70mm/2.75", 8LT7... series



8LT7EL ...
8LT7GL ...
8LT7FL ...

Order code	Description	Qty per pkg	Wt.
		n°	[kg]

Steady light modules. BA15d fitting **ⓘ**.
Bulb (8LT7ALB... and 8LT7ALL...) not included.

8LT7EL1	Orange	1	0.082
8LT7EL3	Green	1	0.082
8LT7EL4	Red	1	0.082
8LT7EL5	Yellow	1	0.082
8LT7EL6	Blue	1	0.082
8LT7EL8	White	1	0.082

Blinking light modules. BA15d fitting **ⓘ**.
Bulb (8LT7ALB... and 8LT7ALL...) not included.

8LT7GLB1	Orange, 24VAC/DC	1	0.083
8LT7GLB3	Green, 24VAC/DC	1	0.083
8LT7GLB4	Red, 24VAC/DC	1	0.083
8LT7GLB5	Yellow, 24VAC/DC	1	0.083
8LT7GLB6	Blue, 24VAC/DC	1	0.083
8LT7GLB8	White, 24VAC/DC	1	0.083
8LT7GLE1	Orange, 110...120VAC	1	0.083
8LT7GLE3	Green, 110...120VAC	1	0.083
8LT7GLE4	Red, 110...120VAC	1	0.083
8LT7GLE5	Yellow, 110...120VAC	1	0.083
8LT7GLE6	Blue, 110...120VAC	1	0.083
8LT7GLE8	White, 110...120VAC	1	0.083
8LT7GLM1	Orange, 230...240VAC	1	0.083
8LT7GLM3	Green, 230...240VAC	1	0.083
8LT7GLM4	Red, 230...240VAC	1	0.083
8LT7GLM5	Yellow, 230...240VAC	1	0.083
8LT7GLM6	Blue, 230...240VAC	1	0.083
8LT7GLM8	White, 230...240VAC	1	0.083

Flash light modules. With 4-joule xenon bulb **ⓘ**.

8LT7FLB1	Orange, 24VAC/DC	1	0.092
8LT7FLB3	Green, 24VAC/DC	1	0.092
8LT7FLB4	Red, 24VAC/DC	1	0.092
8LT7FLB5	Yellow, 24VAC/DC	1	0.092
8LT7FLB6	Blue, 24VAC/DC	1	0.092
8LT7FLB8	White, 24VAC/DC	1	0.092
8LT7FLE1	Orange, 110...120VAC	1	0.092
8LT7FLE3	Green, 110...120VAC	1	0.092
8LT7FLE4	Red, 110...120VAC	1	0.092
8LT7FLE5	Yellow, 110...120VAC	1	0.092
8LT7FLE6	Blue, 110...120VAC	1	0.092
8LT7FLE8	White, 110...120VAC	1	0.092
8LT7FLM1	Orange, 230...240VAC	1	0.092
8LT7FLM3	Green, 230...240VAC	1	0.092
8LT7FLM4	Red, 230...240VAC	1	0.092
8LT7FLM5	Yellow, 230...240VAC	1	0.092
8LT7FLM6	Blue, 230...240VAC	1	0.092
8LT7FLM8	White, 230...240VAC	1	0.092

ⓘ For accessories and spare parts see page 9-9 and 10.

General characteristics

Signal towers are fundamental elements in manufacturing processes for the visual and audible signalling of the system status.

The signal towers can be assembled by stacking up to 7 modules, in the following sequence, starting from the top: red, yellow, orange, blue, green and white.

Technical characteristics

- Maximum operational voltage: 250VAC/DC
- Flash light and sound module consumption:
 - 8LT7FLB... in AC: 135mA
 - 8LT7FLB... in DC: 75mA
 - 8LT7FLE... 20mA
 - 8LT7FLM... 15mA
- Material: polycarbonate or anodised aluminium
- Number of stackable modules: 7
- Connections: screw clamp terminals and maximum conductor section 1.5mm²/16AWG
- Tightening torque: 0.5Nm/4.5lb.in
- Operating temperature: -20...+50°C (12VAC max. up to +40°C)
- IEC degree of protection: IP65.

Certifications and compliance

Certifications obtained: UL Listed, for USA and Canada (cULus - file E318016) as Power Circuit and motor-mounted Apparatus - Stackable tower lights, EAC. Compliant with standards: IEC/EN/BS 60947-5-1, IEC/EN/BS 60947-1, UL508, CSA C22.2 n° 14.

Combinations

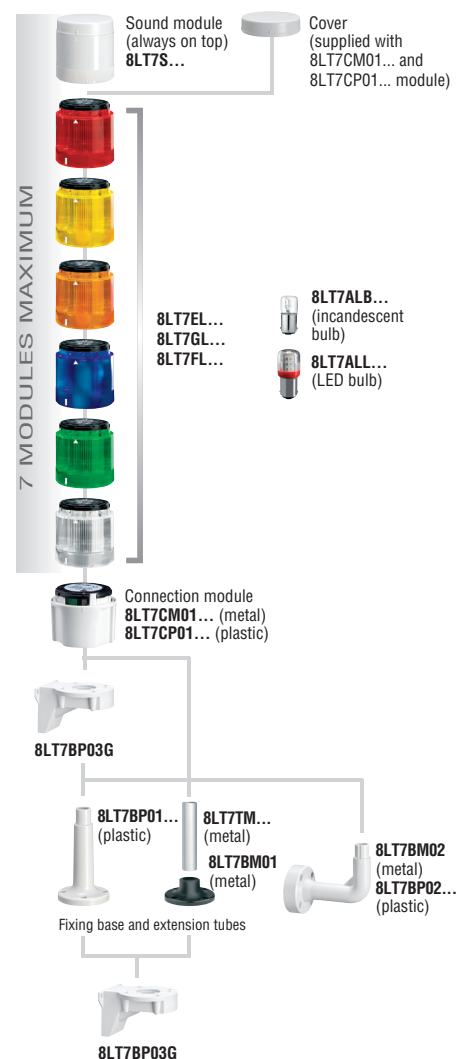

For accessories and spare parts see page 9-9 and 10.

Signal towers Ø70mm/2.75", 8LT7... series



8LT7S...G



8LT7S...



8LT7CM01G
8LT7CP01G



8LT7CM01
8LT7CP01

Order code	Description	Qty per pkg	Wt.
		n°	[kg]

Pulsed or continuous sound modules, grey colour ❶.

8LT7S0BG	24VAC/DC, pulsed (90dB). IP54	1	0.240	
8LT7S1BG	24AC/DC, 16 sounds select. (max. 90dB). IP65	1	0.240	
8LT7S2BG	24VAC/DC	puls. sound (78dB)❷	1	0.240
8LT7S2EG	110...120VAC	or continuous (75dB)❸. IP65	1	0.240
8LT7S2MG	230...240VAC		1	0.240

Pulsed or continuous sound modules, black colour ❶.

8LT7S0B	24VAC/DC, pulsed (90dB). IP54	1	0.240	
8LT7S1B	24AC/DC, 16 sounds select. (max. 90dB). IP65	1	0.240	
8LT7S2B	24VAC/DC	puls. sound (78dB)❷	1	0.240
8LT7S2E	110...120VAC	or continuous (75dB)❸. IP65	1	0.240
8LT7S2M	230...240VAC		1	0.240

Connection modules and cover (bottom entry).

8LT7CP01G	For plastic tubes, grey colour	1	0.110
8LT7CM01G	For metal tubes, grey colour	1	0.120
8LT7CP01	For plastic tubes, black colour	1	0.110
8LT7CM01	For metal tubes, black colour	1	0.120

❶ For accessories and spare parts see page 9-9 and 10.

❷ For 8LT7S2B... = 84.5dB.

❸ For 8LT7S2B... = 82.6dB.

Technical characteristics

- The sound module must always be placed last, on the top of the tower (it cannot be fitted with an 8LT73... multicoloured module).
- Sound module consumption:
 - 8LT7S0B...: 25mA
 - 8LT7S1B...: 40mA
 - 8LT7S2B...: 200mA
 - 8LT7S2E...: 40mA
 - 8LT7S2M...: 30mA
- Material: polycarbonate
- Max. number of sound modules: 1 per tower
- Connections: screw clamp terminals and maximum conductor section 1.5mm²/16AWG
- Tightening torque: 0.5Nm/4.5lb.in
- Operating temperature: -20...+50°C (12VAC max. up to +40°C)
- IEC degree of protection: IP65 (IP54 if 8LT7S0B... sound module used).

Certifications and compliance

Certifications obtained: UL Listed, for USA and Canada (cULus - file E318016) as Power Circuit and motor-mounted Apparatus - Stackable tower lights, EAC. Compliant with standards: IEC/EN/BS 60947-5-1, IEC/EN/BS 60947-1, UL508, CSA C22.2 n° 14.

Combinations

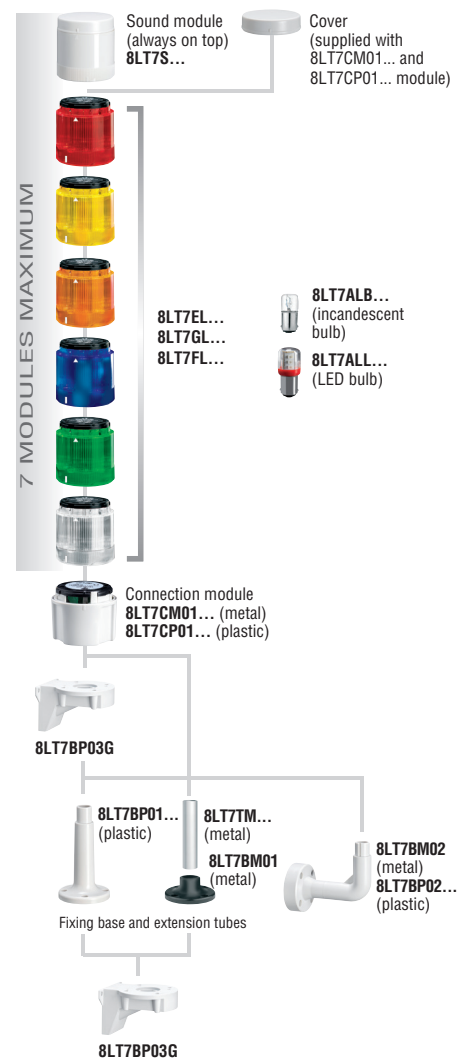

For accessories and spare parts see page 9-9 and 10.

Signal beacons Ø62mm/2.44", 8LB... series



8LB6EL...
8LB6GL...
8LB6S2...

Order code	Description	Qty per pkg	Wt.
		n°	[kg]

Steady light modules. BA15d fitting.
Bulb (8LT7ALB... and 8LT7ALL...) not included.

8LB6EL1	Orange	1	0.060
8LB6EL3	Green	1	0.060
8LB6EL4	Red	1	0.060
8LB6EL5	Yellow	1	0.060
8LB6EL6	Blue	1	0.060
8LB6EL8	White	1	0.060

Blinking or steady light modules. BA15d fitting.
Bulb (8LT7ALB... and 8LT7ALL...) not included.

8LB6GLB1	Orange, 12...48VAC/DC	1	0.060
8LB6GLB3	Green, 12...48VAC/DC	1	0.060
8LB6GLB4	Red, 12...48VAC/DC	1	0.060
8LB6GLB5	Yellow, 12...48VAC/DC	1	0.060
8LB6GLB6	Blue, 12...48VAC/DC	1	0.060
8LB6GLB8	White, 12-48VAC/DC	1	0.060
8LB6GLM1	Orange, 24...230VAC	1	0.060
8LB6GLM3	Green, 24...230VAC	1	0.060
8LB6GLM4	Red, 24...230VAC	1	0.060
8LB6GLM5	Yellow, 24...230VAC	1	0.060
8LB6GLM6	Blue, 24...230VAC	1	0.060
8LB6GLM8	White, 24...230VAC	1	0.060

Light and sound pulsed or continuous sound modules.
Bulb included.

8LB6S2B1	Orange, 24VAC/DC (80dB)	1	0.060
8LB6S2B3	Green, 24VAC/DC (80dB)	1	0.060
8LB6S2B4	Red, 24VAC/DC (80dB)	1	0.060
8LB6S2B5	Yellow, 24VAC/DC (80dB)	1	0.060
8LB6S2B6	Blue, 24VAC/DC (80dB)	1	0.060
8LB6S2B8	White, 24VAC/DC (80dB)	1	0.060

General characteristics

Signal beacons are fundamental elements in manufacturing processes for the visual and audible signalling of the system status.

Technical characteristics

- Maximum operational voltage: 250VAC/DC
- Sound module consumption: 8LB6S2...:150mA
- Material: polycarbonate
- Connections: screw clamp terminals and maximum conductor section 1.5mm²/16AWG
- Tightening torque: 0.5Nm/4.5lb.in
- Operating temperature: -20...+50°C
- IEC degree of protection: IP54 (IP30 if used with bases 8LB6BP04, 8LB6BP06, 8LB6BP08...).

Certifications and compliance

Certifications obtained: EAC.
Compliant with standards: IEC/EN/BS 60947-5-1, IEC/EN/BS 60947-1.

Combinations

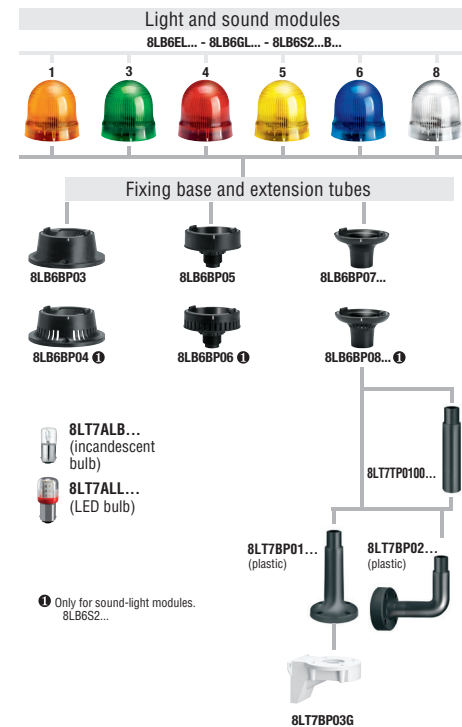

Plastic fixing bases and extension tubes for 8LT... and 8LB... series



8LT7BP01G



8LT7BP01



8LT7BP02G



8LT7BP02

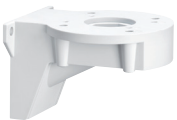

8LT7BP03G



8LT7TP0100G



8LT7TP0100

Order code	Description	Qty per pkg	Wt.
		n°	[kg]
Plastic fixing bases.			
8LT7BP01G	Horizontal surface mount, plastic grey colour with 100mm/3.94" extension	1	0.045
8LT7BP02G	Vertical wall mount, plastic, grey colour	1	0.078
8LT7BP03G	90° vertical wall mount, grey colour	1	0.080
8LT7BP01	Horizontal surface mount, plastic, black colour with 100mm/3.94" extension	1	0.045
8LT7BP02	Vertical wall mount, plastic, black colour	1	0.078
Extension tubes for plastic bases.			
8LT7TP0100G	100mm/3.94", grey colour	1	0.029
8LT7TP0100	100mm/3.94", black colour	1	0.029

General characteristics

The assembly operation for the signal towers is simple and fast and does not require the use of any tools. The bayonet fitting with slight pressure and simple circular movement makes it possible to mount each element on top of the previous one. There are specific white marks to indicate the correct alignment.

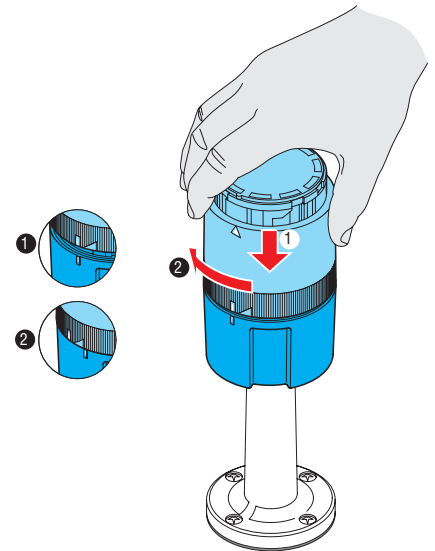

Bulbs for 8LT... and 8LB... series



8LT7ALB...



8LT7ALL...

Order code	Description	Qty per	Wt.
		pkg	
		n°	[kg]
Incandescent bulbs, 5W, BA15d fitting.			
8LT7ALBA	12VAC/DC	10	0.006
8LT7ALBB	24VAC/DC	10	0.006
8LT7ALBE	130VAC/DC	10	0.006
8LT7ALBM	260VAC/DC	10	0.006
LED bulbs, BA15d fitting.			
8LT7ALLA4	Red, 12VAC/DC	10	0.010
8LT7ALLA8	White, 12VAC/DC	10	0.010
8LT7ALLB3	Green, 24VAC/DC	10	0.010
8LT7ALLB4	Red, 24VAC/DC	10	0.010
8LT7ALLB5❶	Yellow/Orange, 24VAC/DC	10	0.010
8LT7ALLB6	Blue, 24VAC/DC	10	0.010
8LT7ALLB8	White, 24VAC/DC	10	0.010
8LT7ALLE3	Green, 110...120VAC	10	0.010
8LT7ALLE4	Red, 110...120VAC	10	0.010
8LT7ALLE5❶	Yellow/Orange, 110...120VAC	10	0.010
8LT7ALLE6	Blue, 110...120VAC	10	0.010
8LT7ALLE8	White, 110...120VAC	10	0.010
8LT7ALLM3	Green, 230...240VAC	10	0.010
8LT7ALLM4	Red, 230...240VAC	10	0.010
8LT7ALLM5❶	Yellow/Orange, 230...240VAC	10	0.010
8LT7ALLM6	Blue, 230...240VAC	10	0.010
8LT7ALLM8	White, 230...240VAC	10	0.010

❶ Used with yellow or orange light modules.

Technical characteristics

- Consumption of bulb fitted on light modules:
 - 8LT7ALBA: 420mA
 - 8LT7ALBB: 210mA
 - 8LT7ALBE: 43mA
 - 8LT7ALBM: 22mA
 - 8LT7ALLA...: <60mA
 - 8LT7ALLB...: <30mA
 - 8LT7ALLE...: <20mA
 - 8LT7ALLM...: <20mA.

Compliance

Compliant with standards: IEC/EN/BS 60947-5-1, IEC/EN/BS 60947-1, UL508, CSA C22.2 n° 14.

Metal fixing bases and extension tube for multicoloured signal towers Ø70mm/2.75" and signal towers assembled Ø45mm/1.77"



8LT7BM01



8LT7BM02



8LT7TM

Order code	Description	Qty per	Wt.
		pkg	
		n°	[kg]
Metal fixing bases.			
8LT7BM01	Horizontal surface mount, metal, black	1	0.099
8LT7BM02	Wall mount, metal	1	0.184
Extension tubes for metal bases, anodised aluminium.			
8LT7TM0100	120mm/4.72"	1	0.016
8LT7TM0200	220mm/8.66"	1	0.024
8LT7TM0300	320mm/12.60"	1	0.048
8LT7TM0400	420mm/16.53"	1	0.064
8LT7TM0500	520mm/20.74"	1	0.080
8LT7TM1000	1020mm/40.16"	1	0.160

Metal fixing bases for 8LB... series



8LB6BP07G



8LB6BP03



8LB6BP05



8LB6BP07



8LB6BP08G



8LB6BP04



8LB6BP06



8LB6BP08

Order code	Description	Qty per pkg n°	Wt. [kg]
Fixing bases for light modules.			
8LB6BP07G	For extension connection, plastic, grey. Use with fixing bases 8LT7BP01G and 8LT7BP02G	1	0.020
8LB6BP03	For horizontal mount, plastic, black	1	0.040
8LB6BP05	For hole Ø22mm/0.87", plastic, black	1	0.040
8LB6BP07	For extension connection, plastic, black. Use with fixing bases 8LT7BP01 and 8LT7BP02	1	0.020
Fixing bases for light and sound modules.			
8LB6BP08G	For extension connection, plastic, grey. Use with fixing bases 8LT7BP01G and 8LT7BP02G	1	0.020
8LB6BP04	For horizontal mount, plastic, black	1	0.040
8LB6BP06	For hole Ø22mm/0.87", plastic, black	1	0.040
8LB6BP08	For extension connection, plastic, black. Use with fixing bases 8LT7BP01 and 8LT7BP02	1	0.020

General characteristics

The assembly operation of the light and sound modules is simple and fast and does not require the use of any tools. There are specific white marks to indicate the correct alignment.

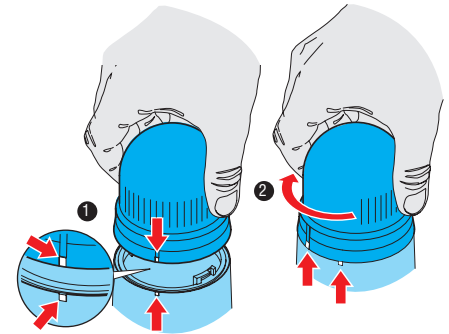

SIGNAL TOWERS READY ASSEMBLED Ø45mm/1.77"

8LT4K02BG

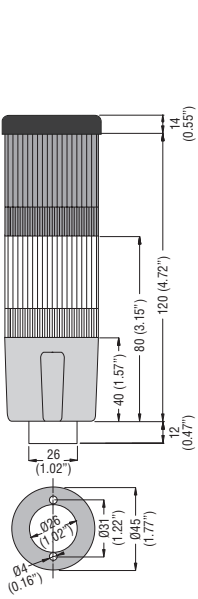

8LT4K03BG

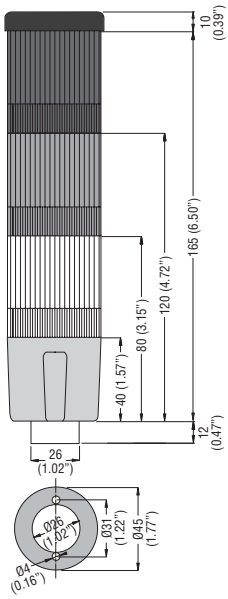

8LT4K04BG

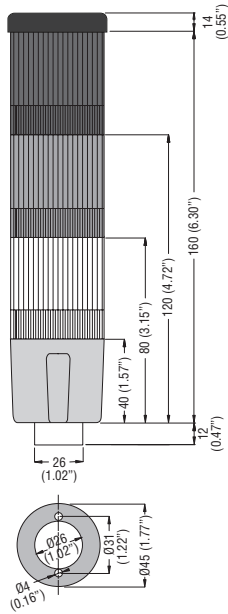

8LT4K05BG

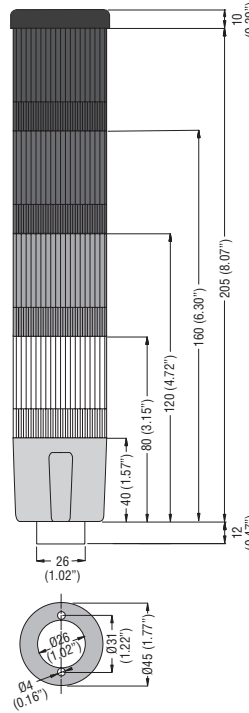

8LT4K06BG

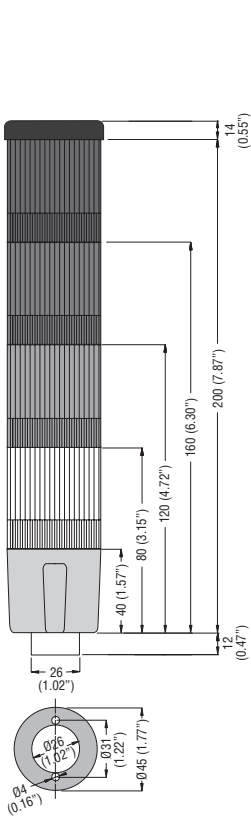

8LT4K07BG

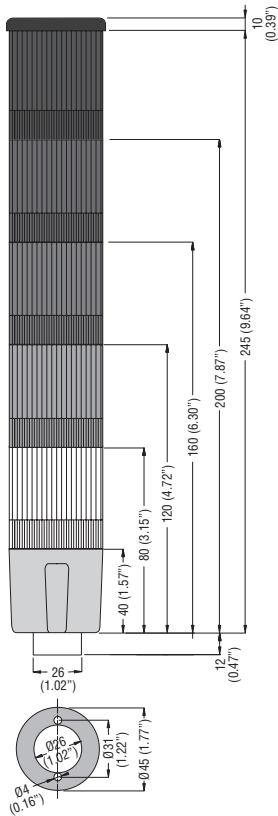

8LT4K08BG

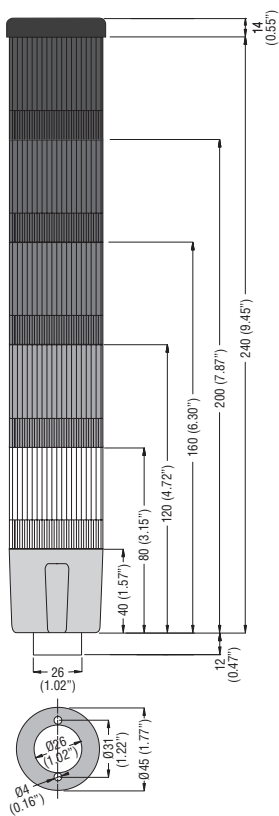

8LT4K09BG

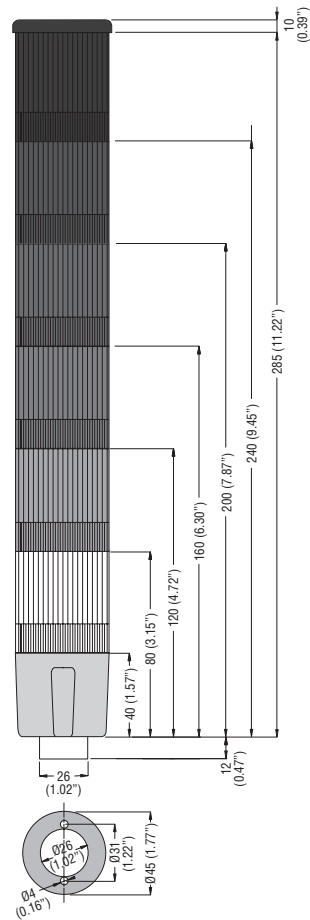

SIGNAL TOWERS Ø50mm/1.97"

Top cover LTN50C

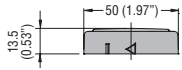

Sound modules LTN50MSH

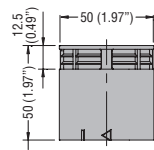

LTN50MSL

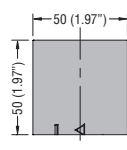

Light modules LTN50ML

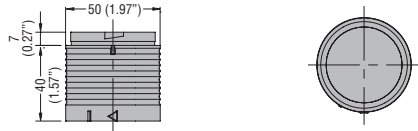

Wiring modules tube mounting

LTN50MW230

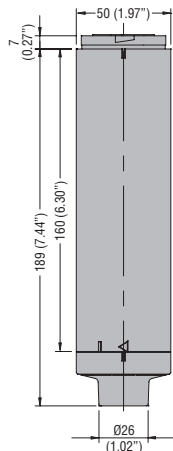

LTN50MW024

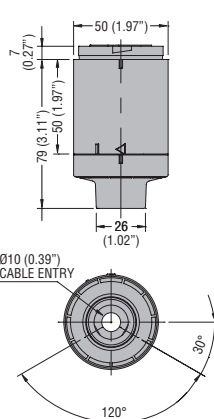

Wiring modules screw mounting

LTN50MWB230

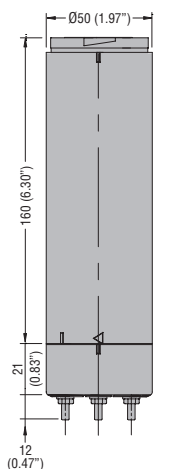

LTN50MWB024

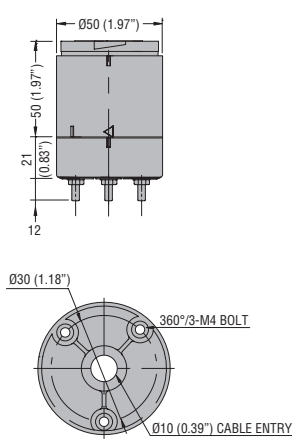

Extension tubes

LTN50P...

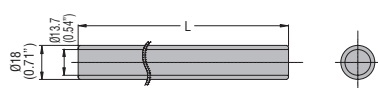

Type	L (mm/in)
LTP50P050	50 (1.97")
LTP50P100	100 (3.94")
LTP50P250	250 (9.84")
LTP50P400	400 (15.75")

LTN50P...T

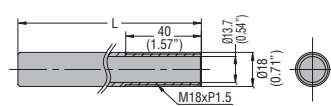

Type	L (mm/in)
LTP50P050T	50 (1.97")
LTP50P100T	100 (3.94")
LTP50P250T	250 (9.84")
LTP50P400T	400 (15.75")

Fixing bases LTN50BP1

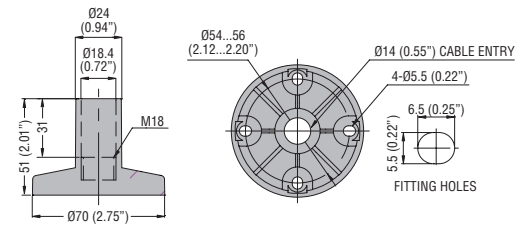

LTN50P2

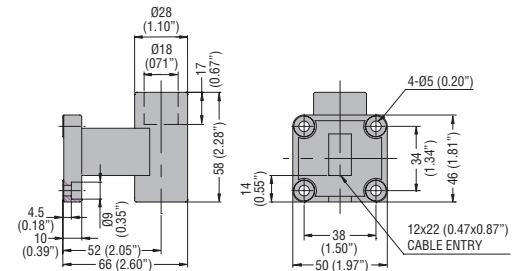

LTN50BP3

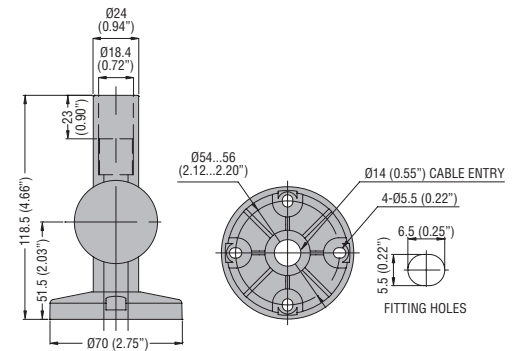

LTN50BM1

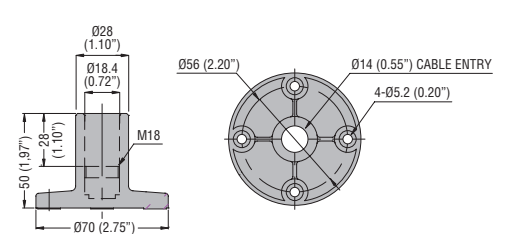

LTN50M2

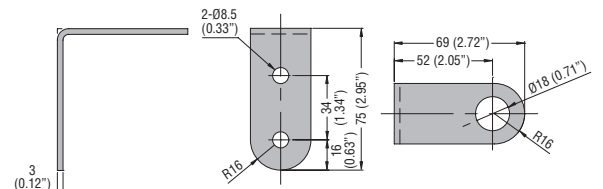

LTN50BM3

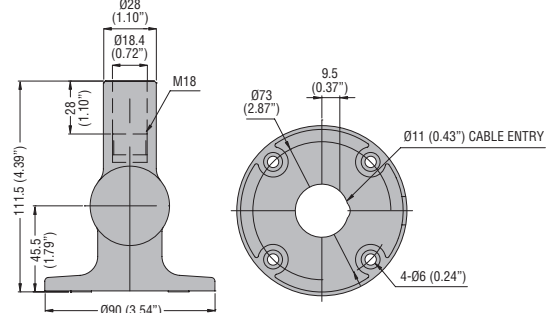

SIGNAL TOWERS Ø70mm/2.75"

Top cover LTN70C

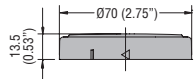

Sound modules LTN70MSH

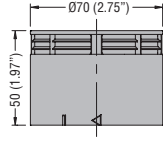

LTN70MSL

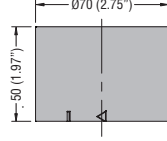

Light modules LTN70ML

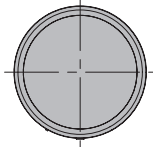
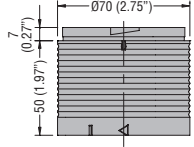

Wiring modules tube mounting LTN70MW230

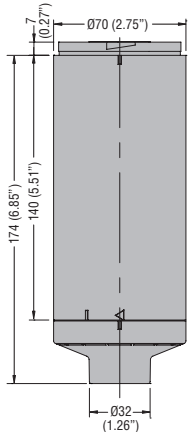

LTN70MW024

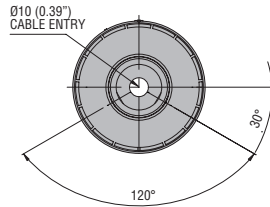
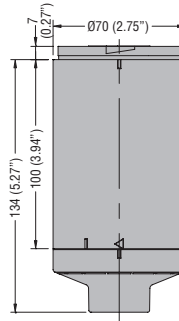

Wiring modules screw mounting LTN70MWB230

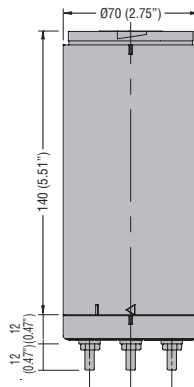

LTN70MWB024

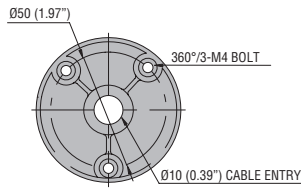
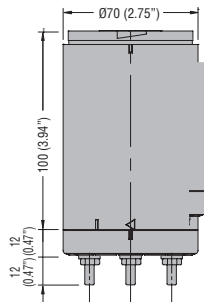

Extension tubes LTN70P...

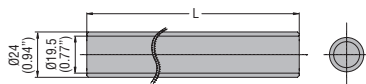

LTN70P...T

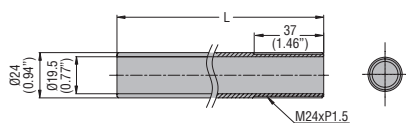

Type	L (mm/in)
LTP70P050	50 (1.97")
LTP70P100	100 (3.94")
LTP70P250	250 (9.84")
LTP70P400	400 (15.75")

Type	L (mm/in)
LTP70P050T	50 (1.97")
LTP70P100T	100 (3.94")
LTP70P250T	250 (9.84")
LTP70P400T	400 (15.75")

Fixing bases LTN70BP1

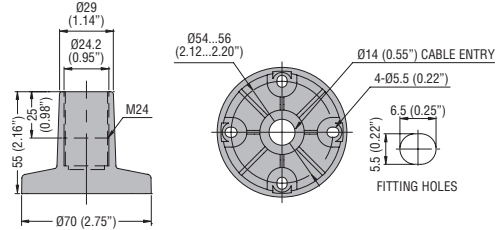

LTN70P2

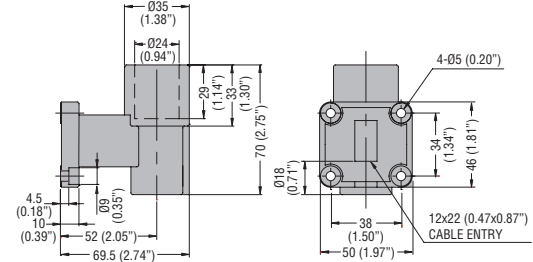

LTN70BP3

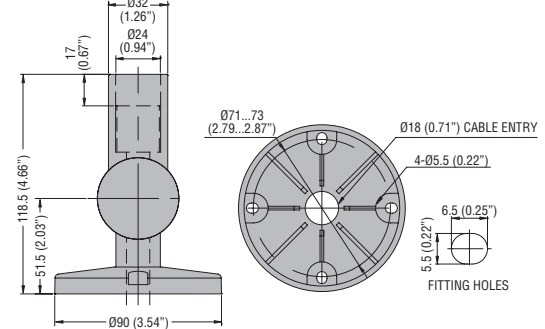

LTN70BM1

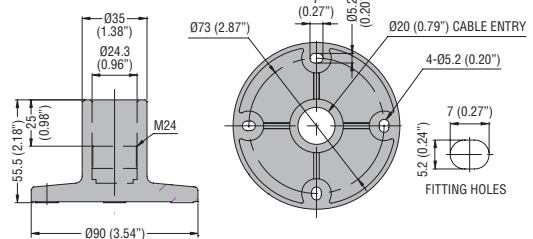

LTN70M2

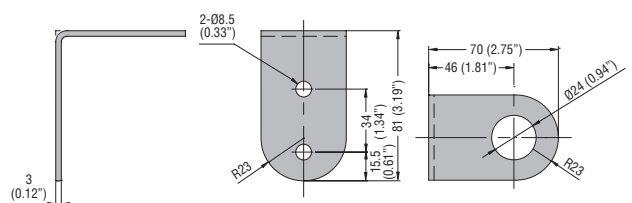

LTN70BM3

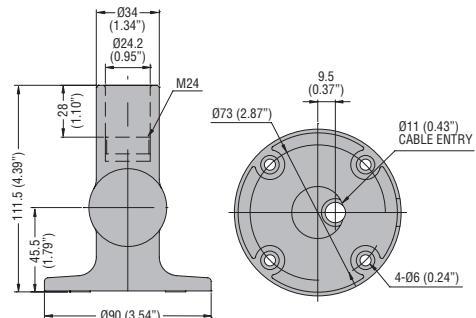

MULTICOLOURED SIGNAL TOWERS Ø70mm/2.75" AND SIGNAL TOWERS Ø70mm/2.75" 8LT... SERIES

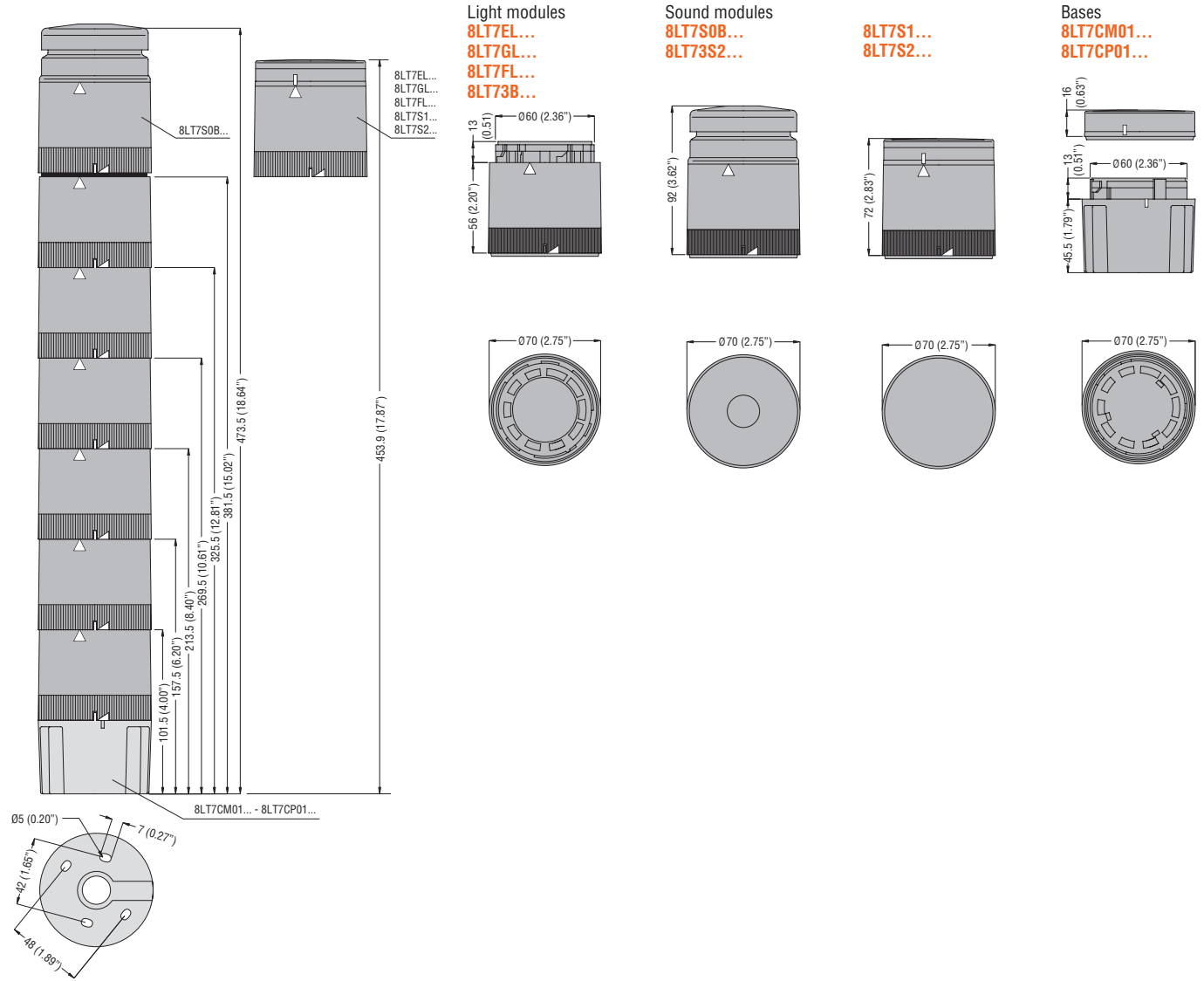

SIGNAL BEACONS Ø62mm/2.44"

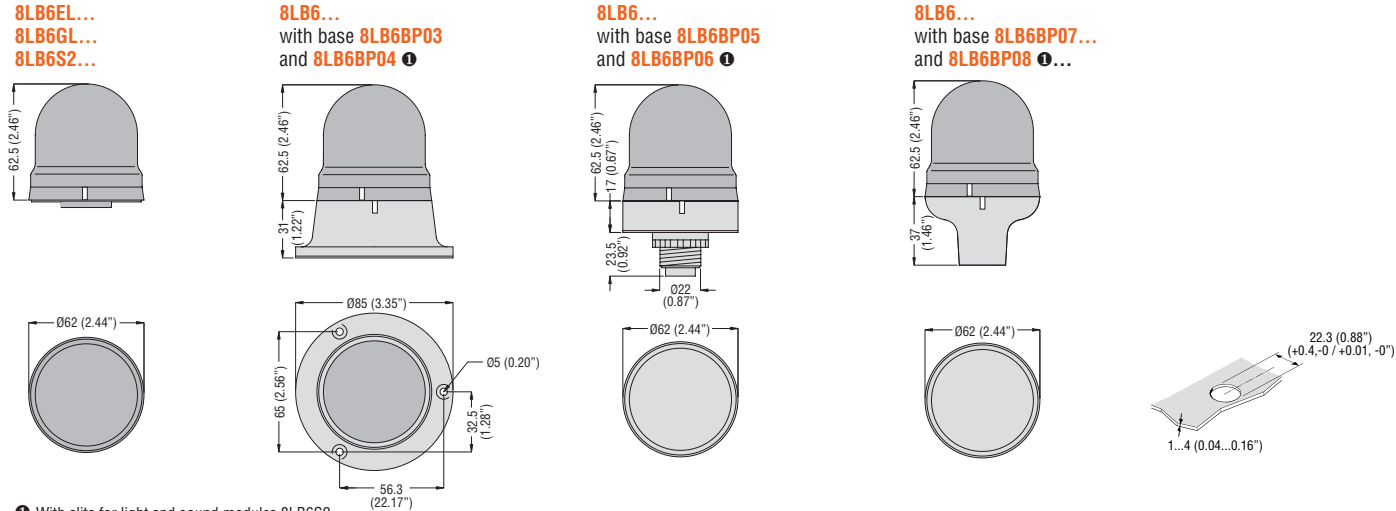

❶ With slits for light and sound modules 8LB6S2...

FIXING BASES AND EXTENSIONS FOR 8LT... SERIES

8LT7BP01...

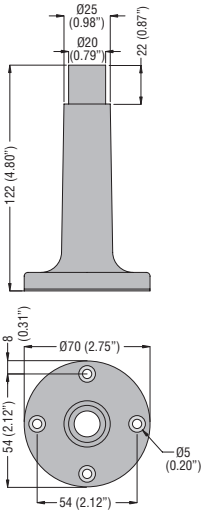

8LT7BP02...

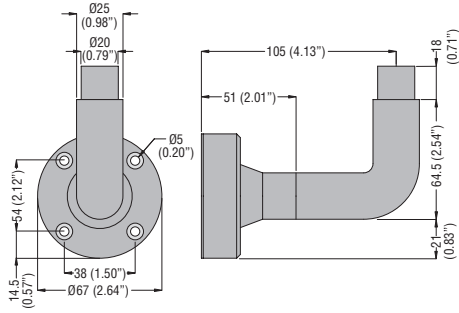

8LT7BM01

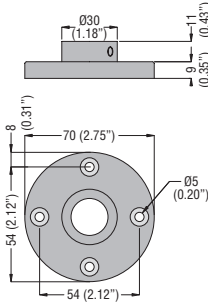

8LT7BM02

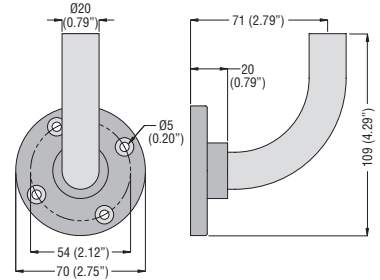

8LT7TP0100...

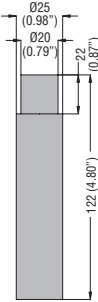

8LT7TM...

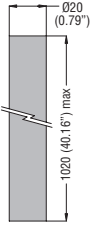

8LT7BP03G

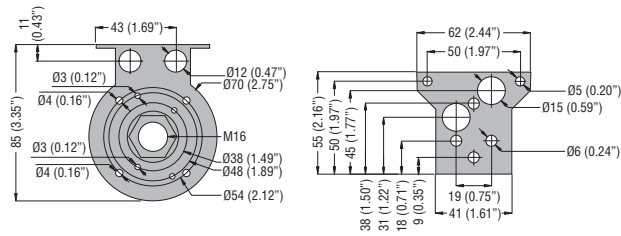

SIGNAL TOWERS ASSEMBLED Ø45mm/1.77"
8LT4...

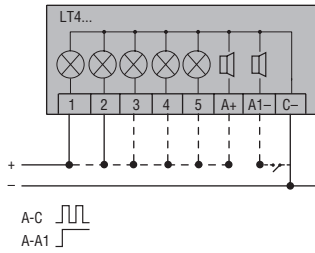

SIGNAL TOWERS Ø50mm/1.97" AND Ø70mm/2.75" LTN... SERIES

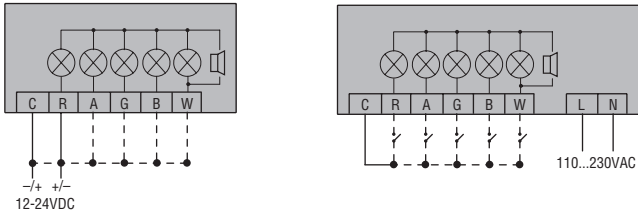

MULTICOLOURED SIGNAL TOWERS Ø70mm/2.75"
 AND SIGNAL TOWERS Ø70mm/2.75"
8LT7...

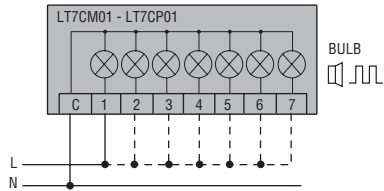

Connect terminals C and 1 as indicated to power the first module.
 If other modules are fitted, the respective terminals must be connected accordingly.

SIGNAL BEACONS Ø62mm/2.44"
8LB6...

