

# SOLUTIONS FOR ENERGY MANAGEMENT



 **Lovato**  
**electric**

ENERGY AND AUTOMATION

## MONITORING AND ENERGY SAVING

In the manufacturing and service industries, **Energy Management** is an issue of strategic importance.

For a modern company, managing energy resources intelligently yields major competitive advantages, thanks to reduced running costs, in addition to its environmental and social benefits.

Effective energy management is based on thorough analysis of consumption to define measures and investments capable of significantly reducing costs.

This requires a systematic approach involving all levels of the organisation. The standard that provides the necessary framework is **UNI CEI EN ISO 50001** "Energy management systems - requirements with guidance for use". This standard also integrates effectively with the ISO 9001 quality and ISO 14001 environmental management systems.

### Model of the energy management system according to UNI CEI EN ISO 50001

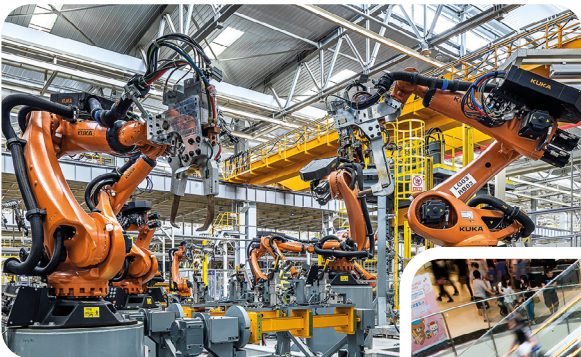
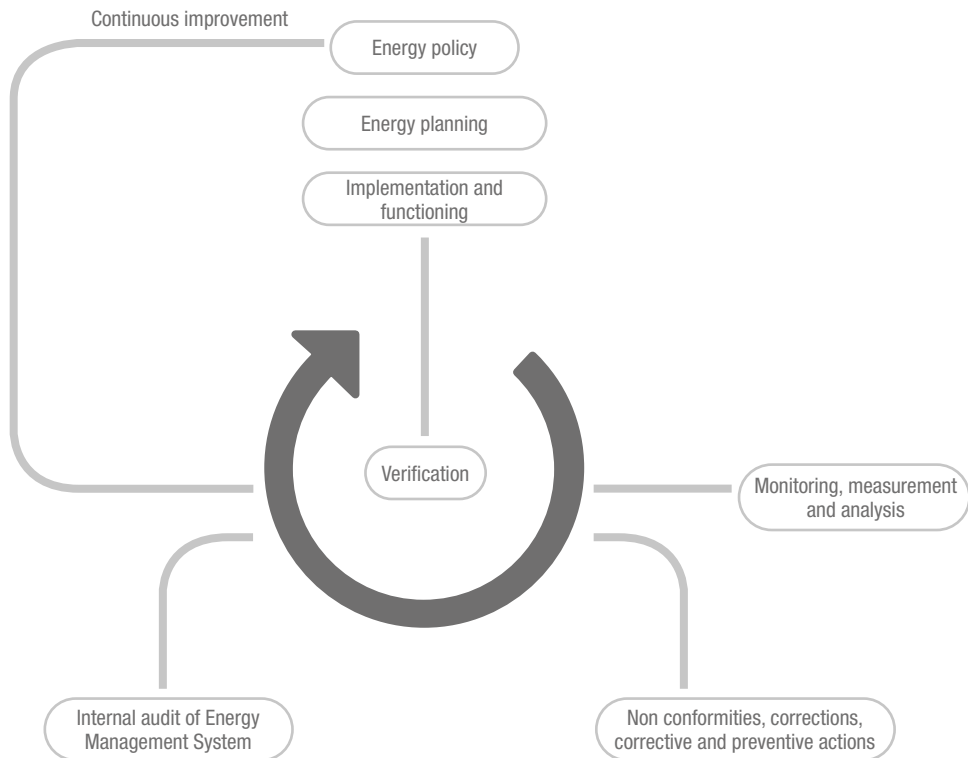

The use of an energy consumption monitoring and analysis system is the prerequisite for satisfying the increasingly stringent legal requirements for **Energy Audits** for large and energy intensive enterprises; it is the essential condition for acquiring the data required by the Energy Services Operator (ESO) to issue **White Certificates**. Furthermore, the issue of the sustainability report is also of growing importance, which in addition to representing a moral commitment will also become a legal obligation.

The outcome of the monitoring and analysis is summarised in an Energy Audit which sets out the energy health of the company and identifies measures for improvement. To ensure that the improvement is continuous, the **Energy Audits** have a periodicity of at least four years, thus verifying the results achieved and the new objectives to be set.

An adequate energy consumption monitoring and analysis system is the principle ally of the company's **Energy Manager** in the difficult task of planning the efficient use of energy resources.

We indicate below the principal factors considered in an effective energy analysis:

### Using no more energy than necessary

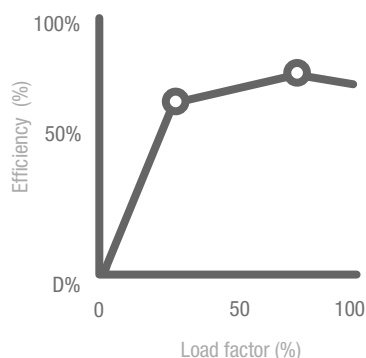

### Flattening off demand

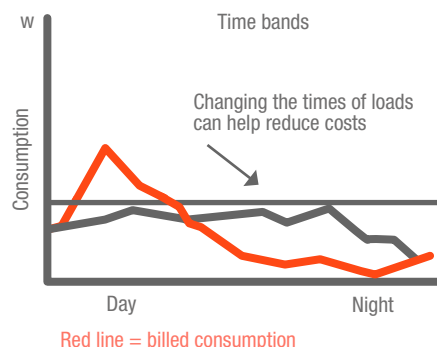

### Avoiding penalties

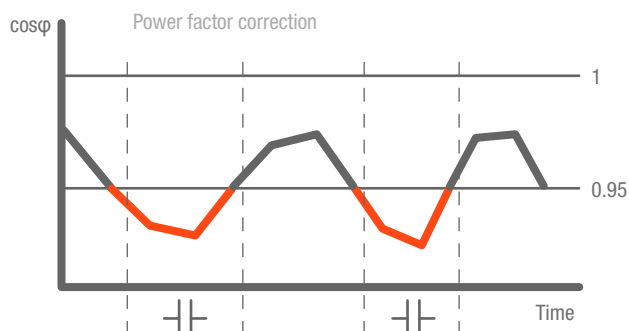

### Identifying mains supply disturbances

#### ENERGY QUALITY COUNTERS

DIPS	5
SWELLS	1
INTERRUPTIONS	8
INTERRUPTIONS > 180s	6
VOLTAGE OUT OF RANGE	1
FREQUENCY OUT OF RANGE	0

#### OFFICES LOG FOR WEEK 4 - 2021

### Division of energy

**Monitoring**

USER: **logica**

- Dashboard
- Devices
- Data log
- Charts
- Alarms
- Report

AMBIENTE / POWER CENTER
**Energy analysis**

Selezione dispositivo: **SPV\_MANTO T**

Measure	Value	UM
V L1-L2	399.4	V
V L2-L3	399.2	V
V L3-L1	396.9	V

Measure	Value	UM
A L1	53.42	A
A L2	54.62	A
A L3	52.02	A

Measure	Value	UM
kW L1	10.58	kW
kW L2	10.51	kW
kW L3	9.73	kW

Measure	Value	UM
COSF L1	0.88	
COSF L2	0.86	
COSF L3	0.82	

V L1-L2

**399.36 V**

A L1

**53.42 A**

kW L1

**10.58 kW**

PF TOT

**0.84**

Shop Active Energy	Compressors Active Energy	Lights Active Energy	Offices Active Energy
<b>0008143488</b>	<b>0007117552</b>	<b>0020967791</b>	<b>0002491975</b>
kWh	kWh	kWh	kWh

# ENERGY MANAGEMENT SOLUTIONS

Measurement devices, automation and control

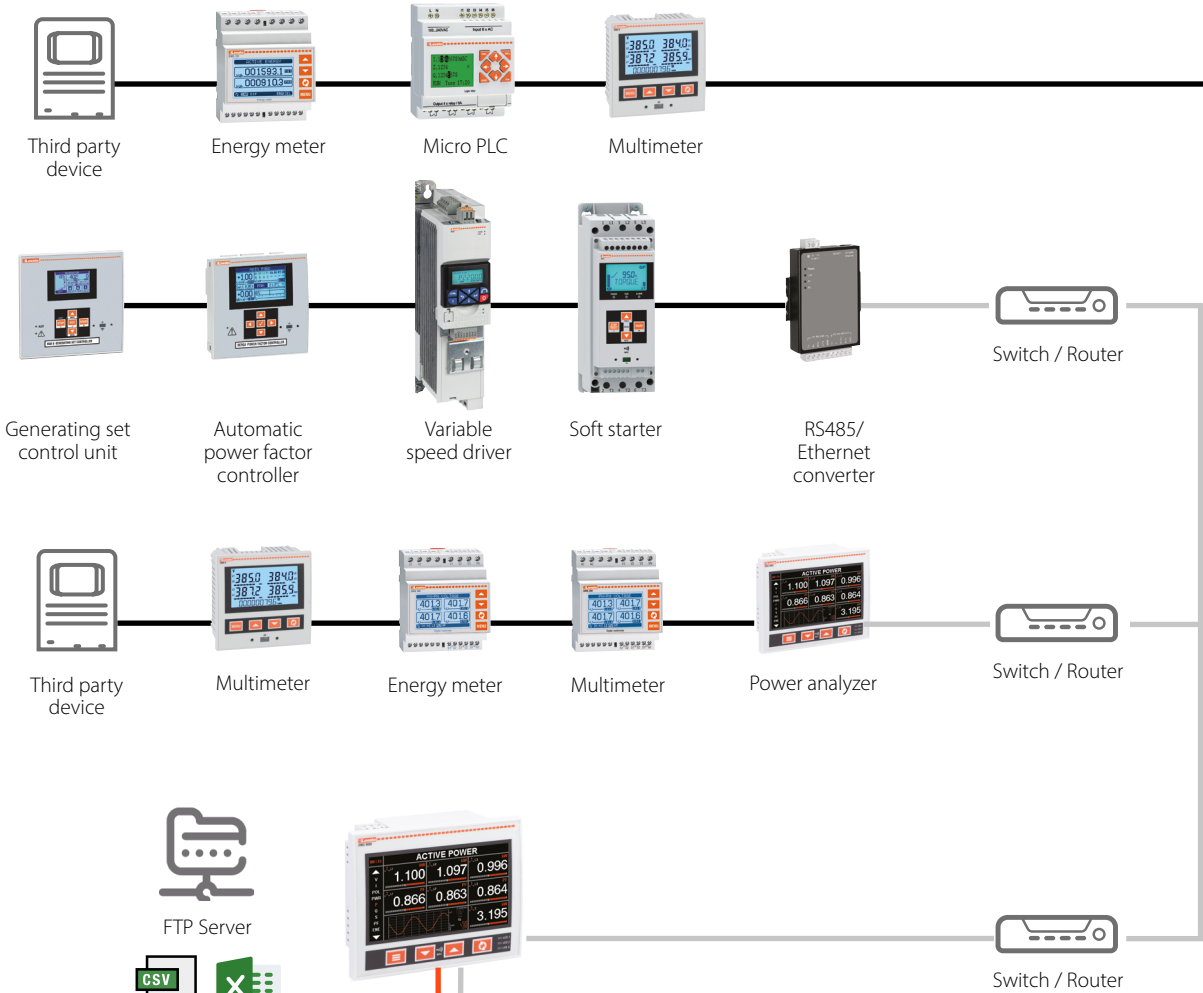

Easy Branch solution

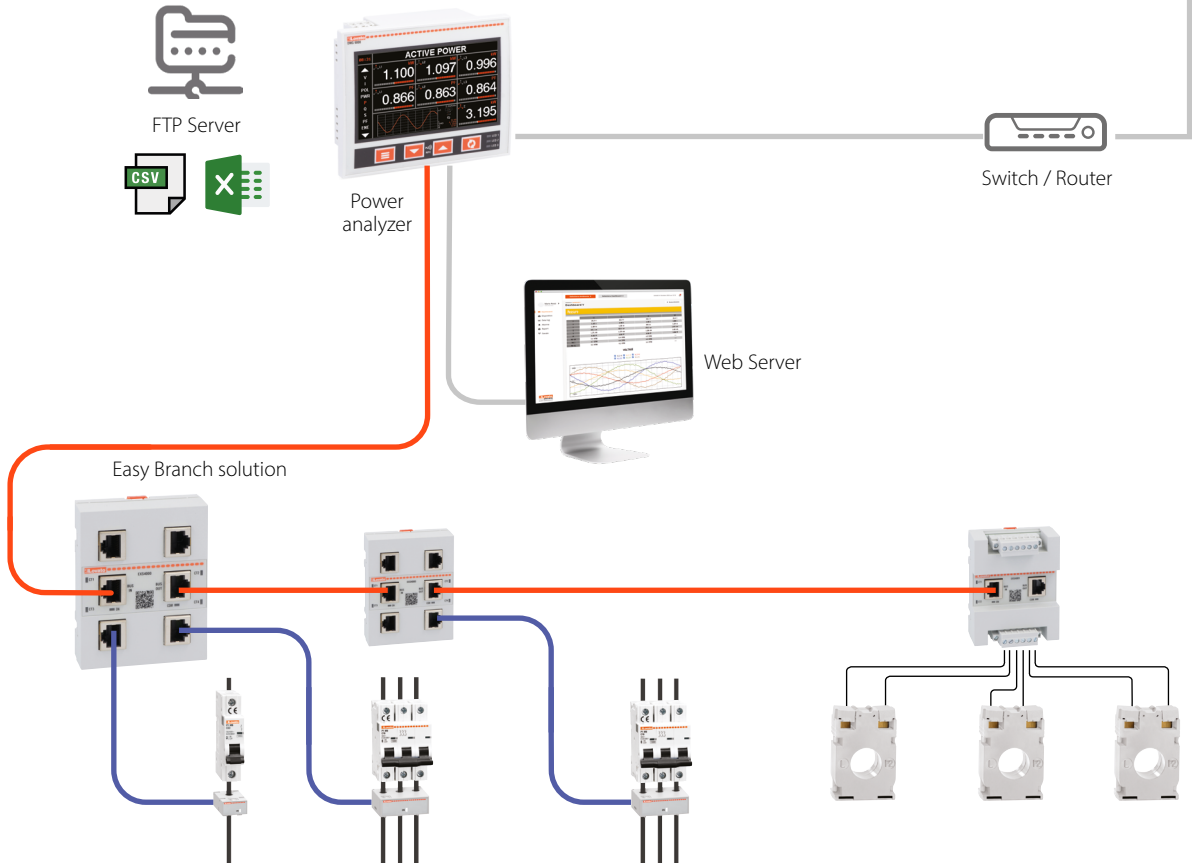

For energy monitoring and energy saving, LOVATO Electric offers an integrated global solution, composed of:

- **hardware devices** for energy measurement and control (power analyzers, multimeters, energy meters, variable speed drives, soft starters, automatic power factor controllers, gateway data loggers, etc.)
- Web Server or Cloud **software** to continuously monitor energy vectors via the Web.

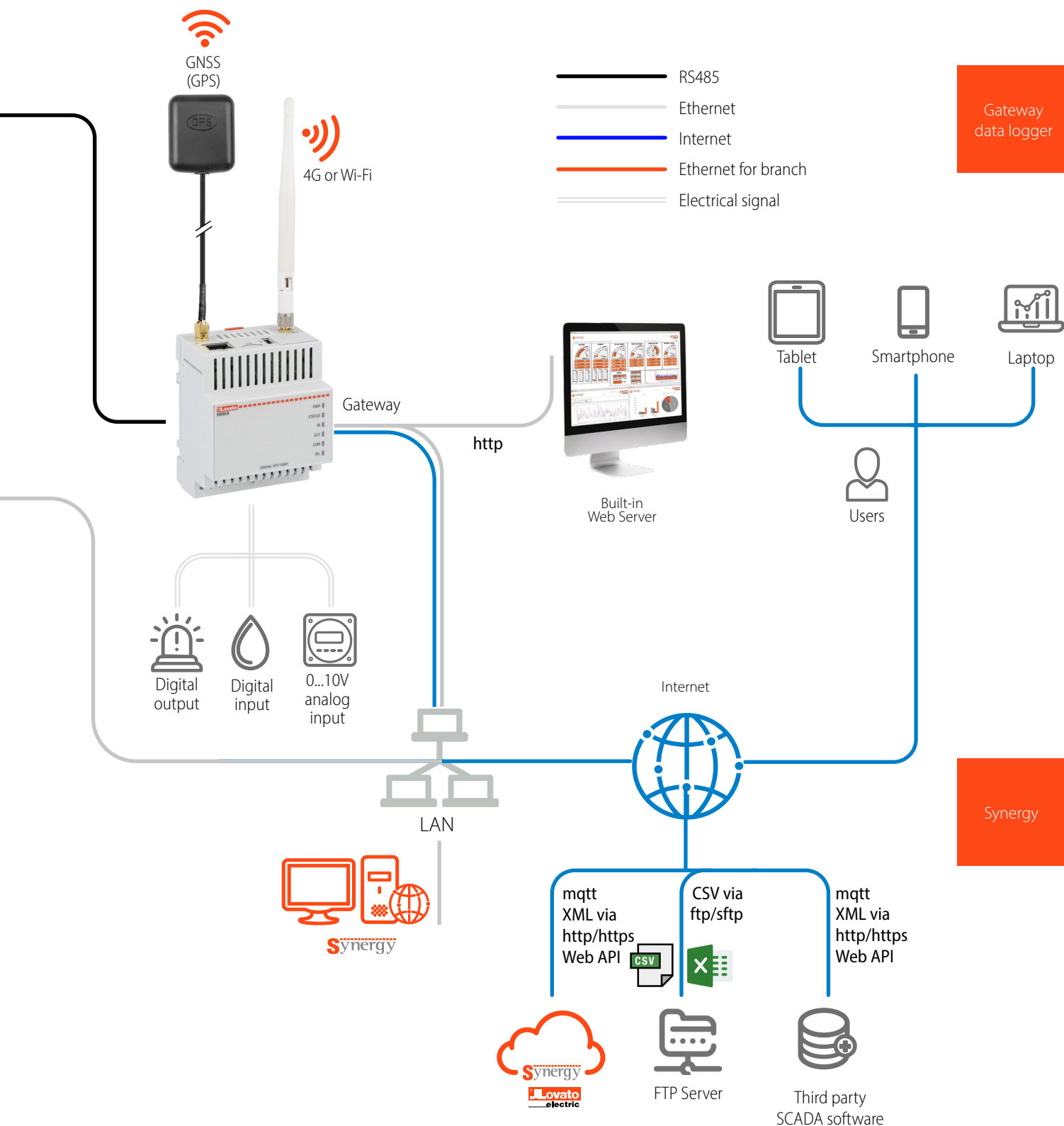

**Synergy** by LOVATO Electric is an energy monitoring and analysis system with a professional, flexible and integrated approach from an Industry 5.0 perspective. Thanks to the LOVATO Electric **measurement devices** equipped with a communication port and through the web-based supervision platform, it is possible to monitor real time measurements, consult graphics, receive alarms, export customized reports and carry out commands and settings.

LOVATO Electric products for automation monitoring and control are perfectly suited to the requirements of companies of all sizes and any industrial application.

Scalable monitoring software and easy integration of new devices mean that the system can be upgraded whenever needed and grow with the application.

LOVATO Electric instruments and electronics feature communications ports which enable them to connect to the **Synergy** software to monitor all critical points of the plant.



### Automatic power factor controllers

These devices monitor the power factor ( $\cos\phi$ ) of the installation and, if the value is too low due to excessive reactive power draw by inductive loads such as motors (which implies payment of penalties to the utility company), automatically engage arrays of capacitors to compensate for the reactive power draw and thus achieve the desired  $\cos\phi$ .



### Interface protection system units

Interface protection systems for the control of voltage and frequency limits for the connection of local generator systems in parallel with medium and low voltage mains power supplies.

LOVATO Electric automatic transfer switches permit the remote management and control of even complex systems thanks to a large number of configuration options and excellent flexibility in the setting of thresholds, controls, delays and alarms.



### Automatic transfer switches



### Soft starters

They are used for soft starting/stopping motors, and thus reduce peak currents, vibrations and mechanical stresses, while improving the motor's electric and mechanical service life. LOVATO Electric soft starters permit the gradual starting and stopping of even large motors (up to 1200A) with two or three controlled phases.



### Variable speed drives

Variable speed drives play a very important role in energy management since not only are they very efficient, but they limit motor starting currents and mechanical stresses as well as regulating motor speed, thus consuming only the power actually demanded by the load.

# Synergy

Lovato Electric S.P.A.



### Energy meters

Single- and three-phase multi-measurement energy meters with direct connection (up to 80A) and indirect via CT, equipped with pulse output or RS485 port with MODBUS or MBUS protocol, certified MID and UTF.



### Measuring instruments

DIN rail and panel mount multimeters with indirect connection via TA and Rogowski sensors up to 6000A; energy quality and harmonic distortion analysis up to the 63rd harmonic; analogue and digital inputs and outputs with boolean logic programming.



### Power analyzers and Easy Branch system

Mains analysers with widescreen colour displays can monitor multiple loads from a single device, thanks to their Easy Branch structure. Simplified cabling, reduced footprint in the enclosure and easy system expansion.

# Energy

These are a valuable complement to the Energy Management system because they are easy to install to machines and enclosures to detect process and environmental data such as: control and operating equipment status/alarms, pressures, flow rates, temperatures, levels, control of local automation, scheduled service management, control of operating equipment.

For use with generating sets (alternative energy sources used in the event of a power cut) LOVATO Electric has designed the RGK product range for generator protection and power source/grid-generator parallel switching control.

The FFL series fire controllers allow the control and monitoring of electric pumps and motor pumps for sprinkler fire protection systems. They are designed according to the EN 12845 standard and incorporate additional features for the supervision, monitoring and maintenance of fire protection systems. Panels are available for remote alarm indication.



### Micro PLCs

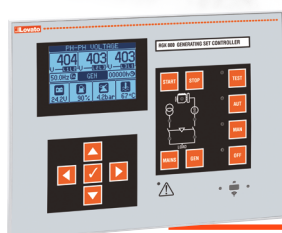

### Generating set controllers

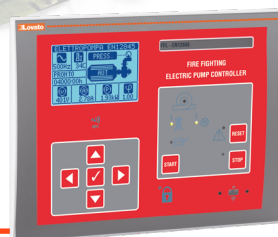

### Fire pumps controllers

# GATEWAY DATA LOGGERS

The **EXCGLB...** is a combined gateway and data logger and is key to the construction of modern, functional and efficient monitoring systems. The device logs data from LOVATO Electric devices or ambient sensors running compatible protocols and monitors all kinds of energy vector (water, air, gas, electricity or steam). Logged data can be consulted via the built-in web server and transmitted either to LOVATO Electric's **Synergy** supervision software or to remote servers in suitable formats for further processing.

## WEB SERVER INTEGRATION

The EXCGLB... is equipped with a built-in web server that lets you:

- consult and download collected data
- view time-referenced charts and tables for historic analyses
- define what categories of collected data must be sent automatically to the **Synergy** supervision software or other destinations.



## AVAILABLE VERSIONS

Communication	EXCGLB01	EXCGLB02	EXCGLB03
RS485 port	● (Modbus RTU master)	● (Modbus RTU master)	● (Modbus RTU master)
Ethernet port	1	1	2 (independent networks)
Wi-Fi connection	●	-	-
4G mobile connection (built-in)	-	● (MicroSim)	● (MicroSim)
GNSS (GPS) function	-	●	-
Digital/Analog input, digital output	1 digital input, 1 analog input 0...10V, 1 digital output @24VDC		
Network protocols and services	MQTT, http/https, VPN client, Modbus TCP master (device side), FTP		

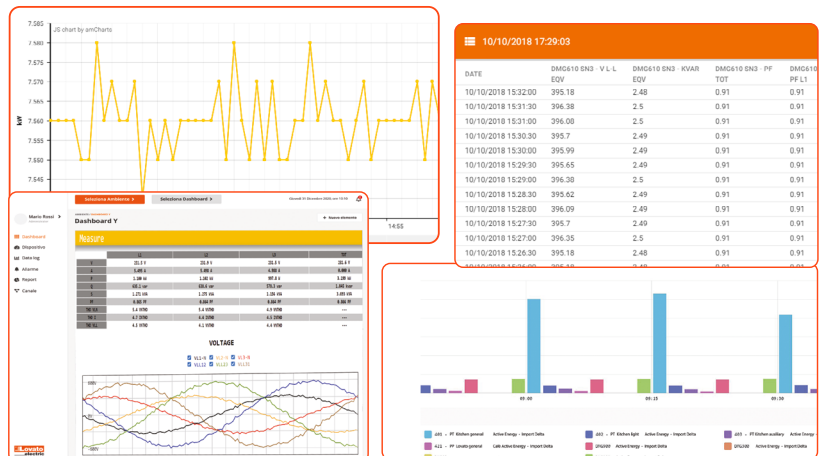

## THIRD PARTY COMPATIBILITY

- Regular transfer of data to third party software in encrypted mode in XML via http/https or CSV files via sftp/ftp.
- Mqtt live data transfer
- Third party modbus devices support

## INTEGRATION WITH Synergy

The **Synergy** energy supervision system is the result of LOVATO Electric's extensive experience in four different but synergic areas: hardware devices, monitoring software, technical assistance and training.

Connecting the EXCGLB... to LOVATO Electric's **Synergy** monitoring services delivers the following advantages:

- automatic access to data loggers, synoptic pages and graphics in a standard configuration that does not require any user intervention
- transmitted data can be processed freely and displayed graphically on web pages that can be customised to meet specific customer needs
- guaranteed data security even in the event of internet instability.

## TECHNICAL CHARACTERISTICS

- Connection to field devices via RS485 and/or Ethernet
- Internet connection via cabled network or modem: independent of customer's network
- Communication with remote servers via http, https and ftps protocols: neither static public IP addresses nor specific TCP ports are needed
- Regular transfer of data to **Synergy** supervision software in encrypted mode in XML files via http/https or CSV files via sftp/ftp.
- Mqtt live data transfer to **Synergy**
- Data and report export via web servers in Excel or CSV format
- Plug & Play: auto-recognition of compatible devices connected via the Ethernet or serial channel.



## ONLY ONE INSTRUMENT FOR THE MONITORING OF 33 THREE-PHASE LOADS

When inside an electrical panel the parameters of several loads have to be monitored, **EASY BRANCH** power monitoring system is a more efficient and simple alternative solution to install than the traditional one which requires an independent instrument for each measuring point.

The electrical distribution panels in shopping centres or in the departments of a production facility represent ideal applications for **EASY BRANCH** system by LOVATO Electric.

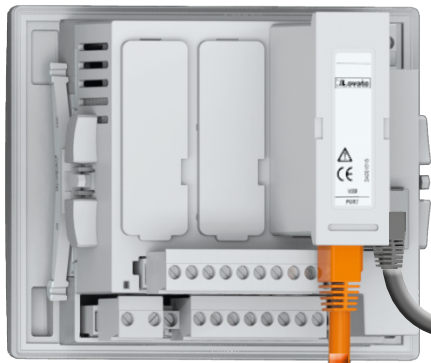

■ 3X DM...A  
Split-core current  
transformers.

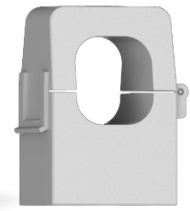

■ CURRENT MEASURING MODULE  
with 4 inputs for electronic RJ45 CTs.

■ MAX 8 EXS4... current measuring modules can be connected to the EXS0000 bus module, to monitor up to:

- 33 three-phase loads
- 99 single phase loads
- mixed configuration.

■ MAX CABLE LENGTH  
from 20m to 100m due  
to fields conditions

■ CURRENT MEASURING MODULE  
with 2 inputs for current transformers.

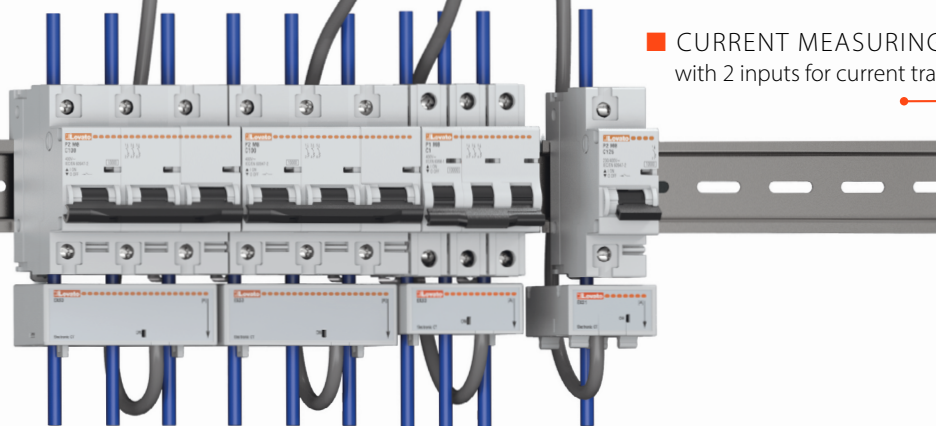

■ MODULE CONFIGURATION  
FROM 32A TO 125A

- Three-phase
- Single-phase
- Three single-phase.

■ 3X DM...  
Current transformers.

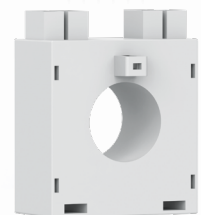

# Synergy

is a supervision and energy management web-based software that provides the monitoring and control of the electrical installation, from every computer or mobile device through the most popular web browsers in a simple and efficient way.

It is valid software to sustain the activities indicated by the standard EN ISO 50001 "Energy management systems. Requirements with guidance for use". In addition to electrical quantities, it allows to check all environmental and process information (operating status, alarms, etc.), acquired from LOVATO Electric products, equipped with communication port, and thereby to carry out commands and parameterising. Integration with external systems (i.e. management systems, MES, Scada and so on) is assured by the option of accessing the database via Web API queries.

**Synergy** enables the user to create custom web pages with widgets featuring graphs, tables, gauges and alarm conditions. The data can be downloaded to the user's computer or forwarded to a designated email address or FTP server at scheduled times. The user can configure the exported files to suit his requirements and represent them in terms of his own models. A flexible, user-friendly, open and scalable energy monitoring system, ready for the challenges of the future.

## FUNCTIONALITY

- The **Synergy** interface is compatible with all common web browsers
- Communication with all LOVATO Electric measurement and control devices, via serial ports, Ethernet or modem
- Integration of third party devices with Modbus
- Reading of instantaneous values
- Definition of custom pages with charts, data tables, measure indicators and alarm conditions
- Data tables which can be exported to customisable files, for example to generate reports with user's logo and post-processing elaborations
- Data access through web API service
- Energy consumption, minimum, maximum and average values of the instantaneous measures divided per time slots
- Alarm management with e-mail notification
- Parameter changing of devices in the field
- User's access level management.

## ALARMS

Each value recorded in the archives (datalogs) can be associated with one or more alarms, that can be reported with the option of automatically sending an e-mail. A specific menu allows the display of detailed information, silencing of alarms and searching of the datalog.

## USER PROFILE

The software has a multi-user, multi-environment structure. The system administrator can handle multiple accesses with a hierarchy of authorisations to suit the needs of his users.

## SERVER-MULTICLIENT SYSTEM

**Synergy** structure and applications are based on a MS SQL relational database management system. These characteristics make **Synergy** a highly versatile system, simultaneously accessible to a large number of users/workstations via intranets, VPN or Internet.

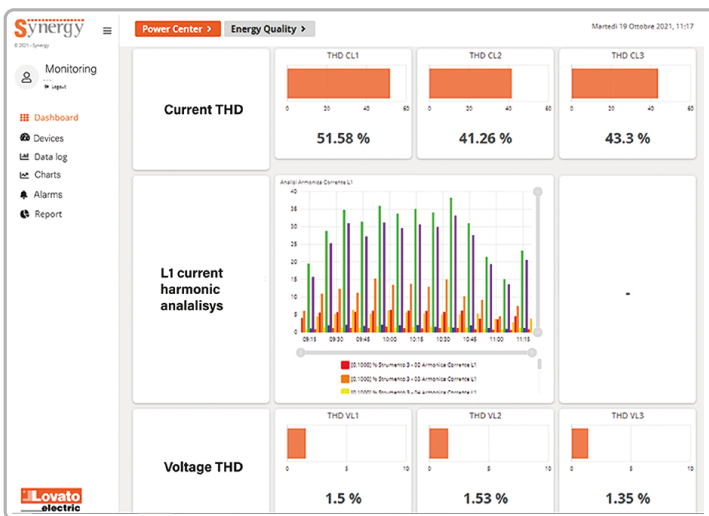

### Multi-devices



### Multi-users



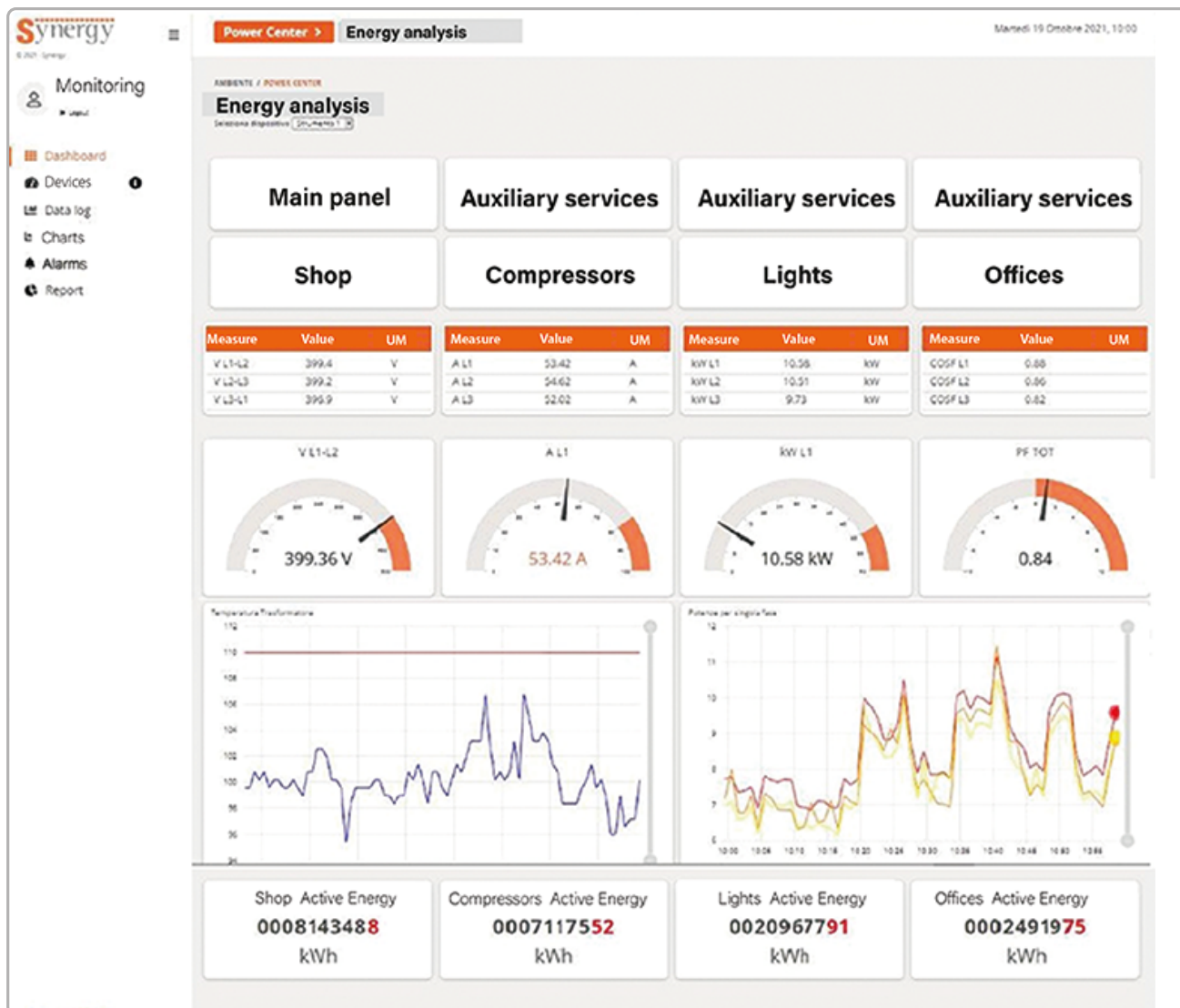

### ■ INTERFACE

The DASHBOARD view displays not only live data indicators, but also graphics and previews of data logs, all in a completely personalisable space accessible from any mobile device or computer.

### ■ DATA LOG

Data logs are used by Synergy to collect its data. The data can be viewed with the software itself, downloaded as files or shared over the Web API.

### ■ CHARTS

The graphs offer a quick overview of trends in the data collected by Synergy. Personalisable, multi-coloured and multi-level, they are the ideal way to understand such trends at a glance.

### ■ SIMPLE, INTUITIVE CONFIGURATION

Programming Synergy does not require any particular computer knowledge since specific configuring instruments have been developed to guide through the configuration of product networks, graphic pages, datalog reports and charts, in a simple and intuitive way.

### ■ REPORT

Reports are used to analyse consumption data and understand the detailed dynamics of the power drawn by the loads. User-friendly graphics and a dedicated layout make it easy for the user to monitor the system's energy consumption.

FURTHER INFORMATION  
consult the site  
[em.LovatoElectric.com](http://em.LovatoElectric.com)



**Synergy** Cloud is a subscription service that allows the supervision and control of systems via LOVATO Electric Cloud server accessible from any computer or mobile device through the most common web browsers. The functions of the **Synergy** Cloud software are the same as those made available with the local installation of the **Synergy** software but without the need to install any software and without the need of a dedicated server at company premises.

The costs of purchase, configuration and maintenance of the hardware and software necessary for energy monitoring are saved.

The devices in the field send the monitored data to the Gateway Data Logger (EXCGLB..) device which collects and represents them at the integrated web server. **Synergy** Cloud lets the user remotely view the live data, receive reports about alarms via e-mail and execute commands (SYN2CLRW licence). With the appropriate licence for supervision and energy management (SYN2CLL licence), **Synergy** Cloud periodically receives via Internet (either wired or mobile network) the data collected by the Gateway Data Logger in order to store historical data, process and represent them graphically as well.

**SECURITY**

The security of the data is guaranteed by HTTPS encryption with certificate between server and client PC, by daily backup of the data collected and by state-of-the-art firewall for server access.

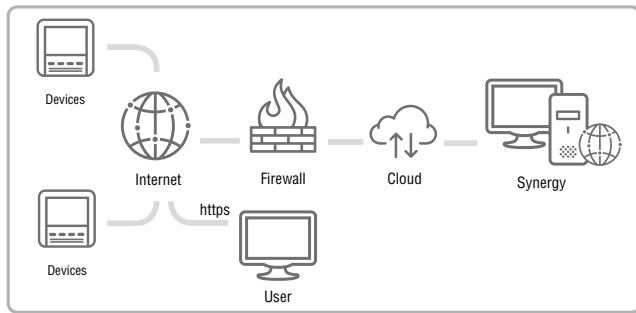

**FEATURES**

- Extremely intuitive interface: no particular technical background required
- Data access from all over the world thanks to the Internet and common browsers
- Specific design for client requirements (selection of measurement scenarios)
- Instantaneous data acquisition from various devices that can even be located in different sites
- Simple and clear reporting of all energy data
- No investment in software database or server
- Extremely secure data thanks to HTTPS and daily backup
- Automatic updates included
- Low cost subscription.



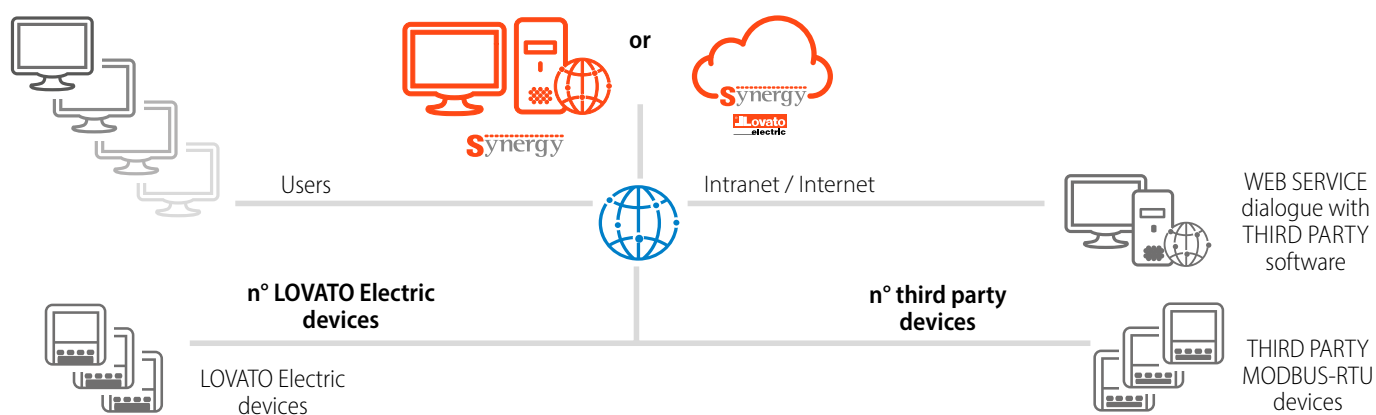

In this solution (On Site), **Synergy** is purchased by the client and installed on his dedicated server, whether physical, virtual or cloud-based (On Customer Cloud). The user acquires permanent licenses for the number of devices he wishes to monitor. Additional licences can be added as needed at a later date. In this way the monitored system can be expanded over time, satisfying both present and future needs.

Order code		Description
<b>Synergy On premises</b>	<b>Synergy Cloud</b>	
SYN2SET	-	Supervision and energy management software web based for Windows operating system
SYN2UPG	-	Update to the latest version of Synergy available for single device
<b>Licences (permanent)</b>	<b>Licence (annual 365)</b>	
SNY2SLL	SNY2CLL	Monitoring function of <b>Synergy</b> / <b>Synergy</b> Cloud, nr. 1 LOVATO Electric device
SYN2SLX	SYN2CLX	Monitoring function of <b>Synergy</b> / <b>Synergy</b> Cloud, nr. 1 THIRD PARTY
SYN2DLWS	SYN2CDLWS	Access function by WEB API to <b>Synergy</b> / <b>Synergy</b> Cloud, MS SQL database
-	SYN2CLRW	Remote view of instantaneous data (creation of alarms and relevant e-mail sending and remote commands) of <b>Synergy</b> Cloud, nr. 1 LOVATO Electric device



## GUIDE TO CHOICE

 <b>MONITORING WITH THE INTEGRATED WEB SERVER ONLY</b> No software but only web server service present on the dataloggers installed.	 <b>REMOTE MONITORING WITH DEDICATED SOFTWARE</b> Monitoring software via LOVATO ELECTRIC CLOUD.	 <b>LOCAL MONITORING WITH DEDICATED SOFTWARE</b> Monitoring software installed on a physical / virtual / cloud server OWNED and supplied by the customer.																								
<i>Local easy access. Small application.</i>	<i>Global easy secure access. Small and big application.</i>																									
<table border="0"> <tr> <td>User license</td> <td>X</td> </tr> <tr> <td>Pre-configured system</td> <td>✓</td> </tr> <tr> <td>Customizable interface</td> <td>X</td> </tr> <tr> <td>Maintenance and updating</td> <td>X</td> </tr> </table>	User license	X	Pre-configured system	✓	Customizable interface	X	Maintenance and updating	X	<table border="0"> <tr> <td>User license</td> <td><b>By subscription</b></td> </tr> <tr> <td>Pre-configured system</td> <td>✓</td> </tr> <tr> <td>Customizable interface</td> <td>✓</td> </tr> <tr> <td>Maintenance and updating</td> <td>✓</td> </tr> </table>	User license	<b>By subscription</b>	Pre-configured system	✓	Customizable interface	✓	Maintenance and updating	✓	<table border="0"> <tr> <td>User license</td> <td><b>On Premises</b></td> </tr> <tr> <td>Pre-configured system</td> <td>X</td> </tr> <tr> <td>Customizable interface</td> <td>✓</td> </tr> <tr> <td>Maintenance and updating</td> <td><b>By subscription</b></td> </tr> </table>	User license	<b>On Premises</b>	Pre-configured system	X	Customizable interface	✓	Maintenance and updating	<b>By subscription</b>
User license	X																									
Pre-configured system	✓																									
Customizable interface	X																									
Maintenance and updating	X																									
User license	<b>By subscription</b>																									
Pre-configured system	✓																									
Customizable interface	✓																									
Maintenance and updating	✓																									
User license	<b>On Premises</b>																									
Pre-configured system	X																									
Customizable interface	✓																									
Maintenance and updating	<b>By subscription</b>																									

### USER LICENSE:

**Use license By subscription:** ANNUAL 365 enabling of supervision, energy management and historical data collection functions for single device connected to LOVATO Electric's Synergy Cloud SERVICE.

**Use license On Premises:** PERMANENT enabling of supervision, energy management and historical data collection functions for single device connected to Synergy SOFTWARE installed on proprietary server.

### PRE-CONFIGURED SYSTEM:

Self-recognition of connected devices, self-creation of dashboards, dataloggers, graphs and reports by default. Reset of start-up times.

### CUSTOMIZABLE INTERFACE:

Ability to customize or independently create dashboards, dataloggers, graphs, reports.

### MAINTENANCE AND UPDATING:

Obtaining updates released during the year with new features, improvements or compatibility with new operating systems.

## TECHNICAL SUPPORT

### ONLINE MYENERGY CONFIGURATOR

**myEnergy**  
CONFIGURATOR

Go to [myenergyconfigurator.lovatoelectric.com](http://myenergyconfigurator.lovatoelectric.com) to design your custom energy monitoring system. At the end of the configuration, you can see the list of materials (BOM), request an offer or request technical support.

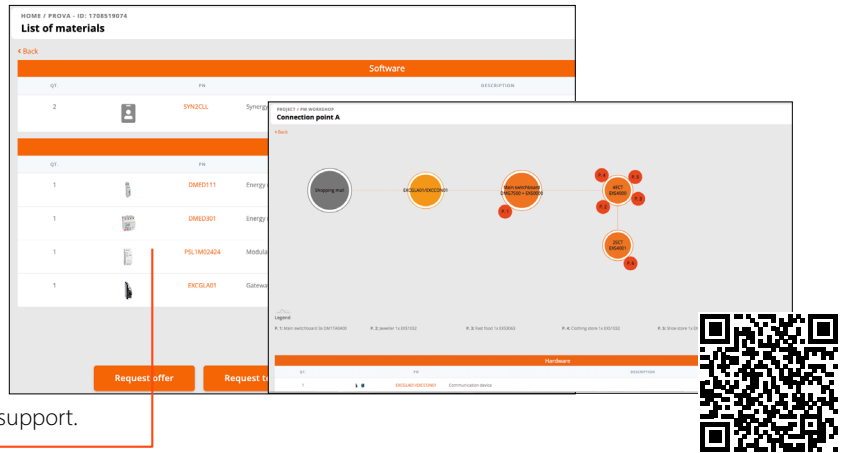

### TECHNICAL SUPPORT

In order to provide the client with a complete, reliable monitoring system, LOVATO Electric provides qualified Technical Support for commissioning the **Synergy** software. The service can be configured as part of the offer to suit the client's requirements.

*LOVATO Electric Technical Support operates through the most communication channels:*



Phone



Mail



Teamviewer



Whatsapp



Teams



Social

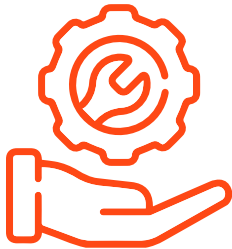

Technical support



On site or remote commissioning of monitoring solution



Support to develop the interface between **Synergy** and THIRD PARTY devices



Training session

ENERGY MANAGEMENT SITE

The site [em.LovatoElectric.com](http://em.LovatoElectric.com) gives not only all updated information about LOVATO Electric energy efficiency and monitoring solutions, but also case histories, demos, contacts and much more.

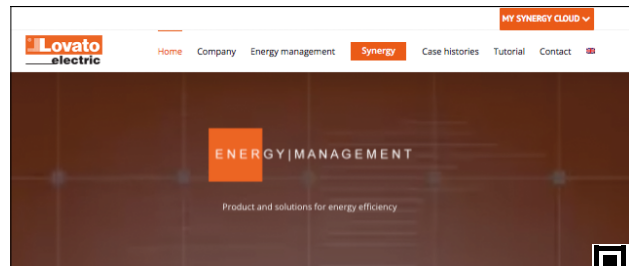

Synergy DEMO SITE

A functioning demo of the monitoring pages automatically generated by Synergy is available at [monitoring.lovatoelectric.com/Synergy2/](http://monitoring.lovatoelectric.com/Synergy2/)

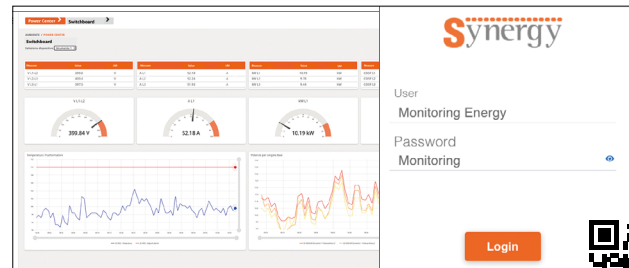

TRAINING ACADEMY SITE

To satisfy the growing demand for technical training for **Energy Management** and industrial automation professionals, LOVATO Academy offers a series of courses on **Energy Management**, micro PLCs, surge protection devices and the starting and control of electric motors. LOVATO Academy courses are detailed on [academy.LovatoElectric.com](http://academy.LovatoElectric.com).

 5 14:00 - 18:45 Convegno Editoriale Delfino Gratuito	 12 14:00 - 18:00 Programmazione PLC Gratuito	 2 14:00 - 18:00 Avanzamento graduale elettronico dei motori Gratuito
 4 14:00 - 17:00 Soluzioni per il monitoraggio energetico industriale	 9 14:00 - 18:00 Scelta dei componenti dell'impianto fotovoltaico	 9 9:00 - 18:00 Programmazione PLC





## SOLUTIONS FOR ENERGY MANAGEMENT



ENERGY AND AUTOMATION

### LOVATO ELECTRIC S.P. A.

via Don E. Mazza, 12  
24020 Gorle (Bergamo), ITALY  
tel +39 035 4282111  
info@LovatoElectric.com

[www.LovatoElectric.com](http://www.LovatoElectric.com)

