

**Lovato**  
electric

**LOVATO ELECTRIC S.P.A.**

24020 GORLE (BERGAMO) ITALIA  
VIA DON E. MAZZA, 12  
TEL. 035 4282111  
TELEFAX (Nazionale): 035 4282200  
TELEFAX (International): +39 035 4282400  
Web [www.LovatoElectric.com](http://www.LovatoElectric.com)  
E-mail [info@LovatoElectric.com](mailto:info@LovatoElectric.com)



**PMVF 60**



## INTERFACE PROTECTION SYSTEM

Compliant with  
SHAMS DUBAI - DRRG Standards Dubai Electricity & Water Authority  
SEC (Saudi Electricity Company) technical standard

### Instruction manual

#### WARNING!

- Carefully read the manual before the installation or use.
- This equipment is to be installed by qualified personnel, complying to current standards, to avoid damages or safety hazards.
- Before any maintenance operation on the device, remove all the voltages from measuring and supply inputs and short-circuit the CT input terminals.
- The manufacturer cannot be held responsible for electrical safety in case of improper use of the equipment.
- Products illustrated herein are subject to alteration and changes without prior notice. Technical data and descriptions in the documentation are accurate, to the best of our knowledge, but no liabilities for errors, omissions or contingencies arising there from are accepted.
- A circuit breaker must be included in the electrical installation of the building. It must be installed close by the equipment and within easy reach of the operator. It must be marked as the disconnecting device of the equipment: IEC/EN 61010-1 § 6.11.3.1
- Clean the device with a soft dry cloth; do not use abrasives, liquid detergents or solvents.



#### ATTENTION !

- Lire attentivement le manuel avant toute utilisation et installation.
- Ces appareils doivent être installés par un personnel qualifié, conformément aux normes en vigueur en matière d'installations, afin d'éviter de causer des dommages à des personnes ou choses.
- Avant toute intervention sur l'instrument, mettre les entrées de mesure et d'alimentation hors tension et court-circuiter les transformateurs de courant.
- Le constructeur n'assume aucune responsabilité quant à la sécurité électrique en cas d'utilisation impropre du dispositif.
- Les produits décrits dans ce document sont susceptibles d'évoluer ou de subir des modifications à n'importe quel moment. Les descriptions et caractéristiques techniques du catalogue ne peuvent donc avoir aucune valeur contractuelle.
- Un interrupteur ou disjoncteur doit être inclus dans l'installation électrique du bâtiment. Celui-ci doit se trouver tout près de l'appareil et l'opérateur doit pouvoir y accéder facilement. Il doit être marqué comme le dispositif d'interruption de l'appareil: IEC/EN 61010-1 § 6.11.3.1
- Nettoyer l'appareil avec un chiffon doux, ne pas utiliser de produits abrasifs, détergents liquides ou solvants.



#### ACHTUNG!

- Dieses Handbuch vor Gebrauch und Installation aufmerksam lesen.
- Zur Vermeidung von Personen- und Sachschäden dürfen diese Geräte nur von qualifiziertem Fachpersonal und unter Befolgung der einschlägigen Vorschriften installiert werden.
- Vor jedem Eingriff am Instrument die Spannungszufuhr zu den Messeingängen trennen und die Stromwandler kurzschließen.
- Bei zweckwidrigem Gebrauch der Vorrichtung übernimmt der Hersteller keine Haftung für die elektrische Sicherheit.
- Die in dieser Broschüre beschriebenen Produkte können jederzeit weiterentwickelt und geändert werden. Die im Katalog enthaltenen Beschreibungen und Daten sind daher unverbindlich und ohne Gewähr.
- In die elektrische Anlage des Gebäudes ist ein Ausschalter oder Trennschalter einzubauen. Dieser muss sich in unmittelbarer Nähe des Geräts befinden und vom Bediener leicht zugänglich sein. Er muss als Trennvorrichtung für das Gerät gekennzeichnet sein: IEC/EN 61010-1 § 6.11.3.1
- Das Gerät mit einem weichen Tuch reinigen, keine Scheuermittel, Flüssigreinerer oder Lösungsmittel verwenden.



#### ADVERTENCIA

- Leer atentamente el manual antes de instalar y utilizar el regulador.
- Este dispositivo debe ser instalado por personal cualificado conforme a la normativa de instalación vigente a fin de evitar daños personales o materiales.
- Antes de realizar cualquier operación en el dispositivo, desconectar la corriente de las entradas de alimentación y medida, y cortocircuitar los transformadores de corriente.
- El fabricante no se responsabilizará de la seguridad eléctrica en caso de que el dispositivo no se utilice de forma adecuada.
- Los productos descritos en este documento se pueden actualizar o modificar en cualquier momento. Por consiguiente, las descripciones y los datos técnicos aquí contenidos no tienen valor contractual.
- La instalación eléctrica del edificio debe disponer de un interruptor o disyuntor. Este debe encontrarse cerca del dispositivo, en un lugar al que el usuario pueda acceder con facilidad. Además, debe llevar el mismo marcado que el interruptor del dispositivo (IEC/EN 61010-1 § 6.11.3.1).
- Limpiar el dispositivo con un trapo suave; no utilizar productos abrasivos, detergentes líquidos ni disolventes.



#### UPOZORNĚNÍ

- Návod se pozorně pročtěte, než začnete regulátor instalovat a používat.
- Tato zařízení smí instalovat kvalifikovaní pracovníci v souladu s platnými předpisy a normami pro předcházení úrazů osob či poškození věcí.
- Před jakýmkoli zásahem do přístroje odpojte měřicí a napájecí vstupy od napětí a zkratujte transformátory proudu.
- Výrobce nenese odpovědnost za elektrickou bezpečnost v případě nevhodného používání regulátoru.
- Výrobky popsané v tomto dokumentu mohou kdykoliv projit úpravami či dalším vývojem. Popisy a údaje uvedené v katalogu nemají proto žádnou smluvní hodnotu.
- Spínač či odpojovač je nutno zabudovat do elektrického rozvodu v budově. Musejí být nainstalovány v těsné blízkosti přístroje a snadno dostupné pracovníkem obsluhy. Je nutno ho označit jako vypínač zařízení přístroje: IEC/EN 61010-1 § 6.11.3.1
- Přístroj čistěte měkkou utěrkou, nepoužívejte abrazivní produkty, tekutá čistidla či rozpouštědla.



#### AVVERTIZARE!

- Cititi cu atentie manualul înainte de instalare sau utilizare.
- Acest echipament va fi instalat de personal calificat, în conformitate cu standardele actuale, pentru a evita deteriorări sau pericolele.
- Înainte de efectuarea oricărei operațiuni de întreținere asupra dispozitivului, îndepărtați toate tensiunile de la intrările de măsurare și de alimentare și scurtcircuitați bornele de intrare CT.
- Producătorul nu poate fi considerat responsabil pentru siguranța electrică în caz de utilizare incorectă a echipamentului.
- Produsele ilustrate în prezentul sunt supuse modificărilor și schimbărilor fără a notifica anterior. Datele tehnice și descrierile din documentație sunt precise, în măsura cunoștințelor noastre, dar nu se acceptă nicio răspundere pentru erorile, omisiunile sau evenimentele neprevăzute care apar ca urmare a acestora.
- Trebuie inclus un disjunctiv în instalația electrică a clădirii. Acesta trebuie instalat aproape de echipament și într-o zonă ușor accesibilă operatorului. Acesta trebuie marcat ca fiind dispozitivul de deconectare al echipamentului: IEC/EN 61010-1 § 6.11.3.1
- Curățați instrumentul cu un material textil moale și uscat; nu utilizați substanțe abrazive, detergenți lichizi sau solvenți.



#### ATTENZIONE!

- Leggere attentamente il manuale prima dell'utilizzo e l'installazione.
- Questi apparecchi devono essere installati da personale qualificato, nel rispetto delle vigenti normative impiantistiche, allo scopo di evitare danni a persone o cose.
- Prima di qualsiasi intervento sullo strumento, togliere tensione e dagli ingressi di misura e di alimentazione e cortocircuitare i trasformatori di corrente.
- Il costruttore non si assume responsabilità in merito alla sicurezza elettrica in caso di utilizzo improprio del dispositivo.
- I prodotti descritti in questo documento sono suscettibili in qualsiasi momento di evoluzioni o di modifiche. Le descrizioni e i dati a catalogo non possono pertanto avere alcun valore contrattuale.
- Un interruttore o disjuntore va compreso nell'impianto elettrico dell'edificio. Esso deve trovarsi in stretta vicinanza dell'apparecchio ed essere facilmente raggiungibile da parte dell'operatore. Deve essere marchiato come il dispositivo di interruzione dell'apparecchio: IEC/EN 61010-1 § 6.11.3.1
- Pulire l'apparecchio con panno morbido, non usare prodotti abrasivi, detergenti liquidi o solventi.



#### UWAGA!

- Przed użyciem i instalacją urządzenia należy uważnie przeczytać niniejszą instrukcję.
- W celu uniknięcia obrażeń osób lub uszkodzenia mienia tego typu urządzenia muszą być instalowane przez wykwalifikowany personel, zgodnie z obowiązującymi przepisami.
- Przed rozpoczęciem jakichkolwiek prac na urządzeniu należy odłączyć napięcie od wejść pomiarowych i zasilania oraz zewrzeć zaciski przekładnika prądowego.
- Producent nie przyjmuje na siebie odpowiedzialności za bezpieczeństwo elektryczne w przypadku niewłaściwego użytkowania urządzenia.
- Produkty opisane w niniejszym dokumencie mogą być w każdej chwili udoskonalone lub zmodyfikowane. Opisy oraz dane katalogowe nie mogą mieć w związku z tym żadnej wartości umownej.
- W instalacji elektrycznej budynku należy uwzględnić przelącznik lub wyłącznik automatyczny. Powinien on znajdować się w bliskim sąsiedztwie urządzenia i być łatwo osiągalny przez operatora. Musi być oznaczony jako urządzenie służące do wyłączania urządzenia: IEC/EN 61010-1 § 6.11.3.1
- Urządzenie należy czyścić miękką szmatką, nie stosować środków ściernych, płynnych detergentów lub rozpuszczalników.



#### 注意

- 装置 設置 設置 - 請仔細閱讀本手冊。
- 將設備只能由合格人員根據現行標準進行安裝，否則可能導致損壞或安全危害。
- 對設備進行任何維護操作前，請確保切斷測量電壓和電源輸入電壓，並將 CT 輸入端子。
- 製造商不負責因設備使用不當導致的電氣安全問題。
- 產品說明如有變動和變化，恕不另行通知。我們竭誠確保技術數據準確，但對錯誤、遺漏或由此引起的意外事件概不負責。
- 鋼鐵空電氣裝置中必須裝有斷路器。斷路器必須安裝在靠近設備且方便操作人員觸及的地方。還必須將斷路器標記為設備的斷開裝置：IEC/EN 61010-1 § 6.11.3.1
- 請使用柔軟的干布清潔設備；切勿使用研磨劑、洗滌液或溶劑。



#### ПРЕДУПРЕЖДЕНИЕ!

- Прежде чем приступать к монтажу или эксплуатации устройства, внимательно ознакомьтесь с содержанием настоящего руководства.
- Во избежание травм или материального ущерба монтаж должен осуществляться только квалифицированным персоналом в соответствии с действующими нормативами.
- Перед проведением любых работ по техническому обслуживанию устройства необходимо обесточить все измерительные и питающие входные контакты, а также замкнуть коротко входные контакты трансформатора тока (ТТ).
- Производитель не несет ответственность за обеспечение электробезопасности в случае ненадлежащего использования устройства.
- Изделия, описанные в настоящем документе, в любой момент могут подвергнуться изменениям или усовершенствованиям. Поэтому каталожные данные и описания не могут рассматриваться как действительные с точки зрения контрактов
- Электрическая сеть здания должна быть оснащена автоматическим выключателем, который должен быть расположен вблизи оборудования в пределах доступа оператора. Автоматический выключатель должен быть промаркирован как отключающее устройство оборудования: IEC/EN 61010-1 § 6.11.3.1
- Очистку устройства производить с помощью мягкой сухой ткани, без применения абразивных материалов, жидких моющих средств или растворителей.



#### DIKKATI!

- Montaj ve kullanımdan önce bu el kitabını dikkatle okuyunuz.
- Bu aparatları kişilere veya nesnelere zarar verme ihtimaline karşı yürürlükte olan sistem kurma normlarına göre kalifiye personel tarafından monte edilmelidir.
- Aparatı (cihaz) herhangi bir müdahalede bulunmadan önce ölçüm girişlerinde gerilimi kesip akım transformatorlerinde kısa devreyaptırınız.
- Üretici aparatın hatalı kullanımdan kaynaklanan elektriksel güvenliği ait sorumluluk kabul etmez.
- Bu dokümanda tarif edilen ürünler her an evrimlere veya değişimlere açıktır. Bu sebeple katalogdaki tarif ve değerler herhangi bir bağlayıcı değeri haiz değildir.
- Binanın elektrik sisteminde bir anahtar veya şalter bulunmalıdır. Bu anahtar veya şalter operatörün kolaylıkla ulaşabileceği yakın bir yerde olmalıdır. Aparatı (cihaz) devreden çıkartma görevi yapan bu anahtar veya şalterin markası: IEC/EN 61010-1 § 6.11.3.1
- Aparatı (cihaz) sıvı deterjan veya solvent kullanarak yumuşak bir bez ile siliniz aşındırıcı temizlik ürünleri kullanmayın.



CONTENTS	Page	Page
Introduction .....	2	Autotest (self test) function..... 8
Description .....	2	Alarm indications ..... 9
Trip thresholds .....	2	Self-diagnosis ..... 9
Front button functions .....	3	Current, power and energy measurements ..... 9
Displaying measurements .....	3	Power Imbalance Limit (LSP) control ..... 9
Table of display pages .....	4	Communication..... 10
Main menu .....	5	Connection schemes ..... 10
Password-protected access .....	5	Backup activation modes..... 11
Setting parameters (set-up) .....	5	Terminal layout ..... 11
Parameter table .....	6	Mechanical dimensions ..... 11
Commands Menu .....	8	Technical specifications..... 12

**INTRODUCTION**

The PMVF 60 equipment has been designed as an Interface Protection (IP) in accordance with the SHAMS DUBAI - DRRG Standards Version 2.0 Dubai Electricity & Water Authority and SEC (Saudi Electricity Company) technical standard version 2.5. It can be applied to all LV and MV micro-generation systems (photovoltaic, wind) where it is used to control the interface switch between generation system and public grid.

In the event of problems on the grid (e.g. due to maintenance), the system trips by opening the Interface switch (e.g. contactor) and isolating the generation system. In the event of Interface switch (IS) failure, it can also control a backup device to disconnect the generation system in any case.

The equipment features 4 digital inputs permitting the connection of the system to the signals provided by the network operator to meet the requirements of the current regulations. The functions implemented and the possibility of further expansion ensure that it is prepared for any developments to the protection system.

The PMVF 60 equipment is supplied already programmed and assembled. With the factory settings, once the connections have been made, it is ready for operation in compliance with the requirements of the SHAMS DUBAI - DRRG Standards Version 2.0 without requiring any further settings to be made. PMVF60 can be switched to SEC (Saudi Electricity Company) technical standard version 2.5 by the command menu. It is nevertheless prepared for any future changes to the operating parameters. Changes to the settings are password protected, preventing tampering by unauthorised personnel.

**DESCRIPTION**

- Modular construction for DIN rail, 6 units.
- LCD graphic 128x80 pixel, backlit, 4 grey levels.
- 4 display and setting buttons.
- Voltage measuring inputs three-phase + neutral.
- Possibility of operation in the following line configurations:
  - Three-phase with neutral, VL-L voltage controls (default).
  - Three-phase with neutral, VL-N voltage controls.
  - Three-phase without neutral, VL-L voltage controls.
  - Single-phase, VL-N voltage control.
- 2 switching-relay outputs to control:
  - OUT1: IS (Interface switch) coil control.
  - OUT2: Backup device control.
- 4 contact digital inputs for:
  - INP1: IS feedback input (auxiliary closure indication contact).
  - INP2: Remote frequency threshold selection input (external signal).
  - INP3: Interface protection disabling signal.
  - INP4: Remote tripping control input.
- Optional power imbalance limit (LSP) threshold control.
- Settings lock via 2-level changeable password.
- Optional additional measurements, via connection of external CTs:
  - Currents.
  - Powers.
  - Energies supplied.
- Set up for future installation of Interface module.
- Optional power imbalance limit (LSP) threshold control in two possible modes:
  - IS trip (OUT1) when LSP exceeded.
  - Separate output switching (OUT3) on additional expansion module for LSP trip indication.
- Programmable multifunctional output (OUT4) on additional expansion module.
- Autotest (Self-test function).

**TRIP THRESHOLDS**

- Below are the voltage and frequency trip thresholds for which the equipment is set up according to the factory defaults, which correspond to the default requirements of the standards.

Voltage threshold	SHAMS DUBAI Default (%)	SHAMS DUBAI Default (s)	SEC Default (%)	SEC Default (s)
Vmax 59-2 (59>>)	115 %	0.20 s	120 %	0.20 s
Vmax 59-Av (59>)	110 %	3.00 s	110 %	3.00 s
Vmin 27-1 (27<)	85 %	0.40 s	90 %	0.40 s
Vmin 27-2 (27<<)	40 %	0.20 s	40 %	0.20 s

- The frequency thresholds and corresponding delays may vary in accordance with the state of the input signals named *External Signal (SHAMS DUBAI only)*.
- The table indicating trip thresholds and times in the conditions envisaged follows:

External Signal for SHAMS DUBAI (do not consider for SEC)	Frequency threshold	SHAMS DUBAI Default (Hz)	SHAMS DUBAI Default (s)	SEC Default (Hz)	SEC Default (s)
ON	81>-2 (81>>)	OFF	0.10 s	62.50 Hz	0.10 s
OFF	81>-1 (81>)	52.50 Hz	0.10 s	OFF	0.10 s
OFF	81<-1 (81<)	47.50 Hz	4.00 s	57.50 Hz	4.00 s
ON	81<-2 (81<<)	OFF	4.00 s	57.00 Hz	0.10 s

The thresholds used during IP operation and the corresponding delays are displayed in a dedicated video page:

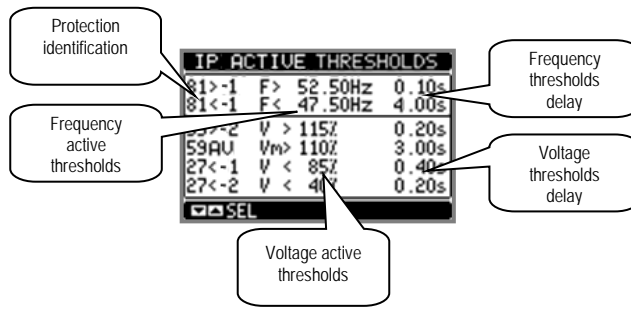

**FRONT BUTTON FUNCTIONS**

**MENU** button – Used to enter or exit the various display and set-up menus.

**Buttons ▲ and ▼** – Used to scroll between screens, select from available options on the display and change (increase/decrease) settings.

**Button ◀** – Used to scroll sub-pages, confirm selected options and switch between display modes.

**DISPLAYING MEASUREMENTS**

The ▲ and ▼ buttons allow the measurement display pages to be scrolled one at a time. The current page is shown on the title bar.

The first page displayed (main page) contains all the most important information in both numerical and graphical form. The limit thresholds are indicated by a small marker above the graphic bar, while the arrows under the graphic bar indicate the measurement range (HI-LO).

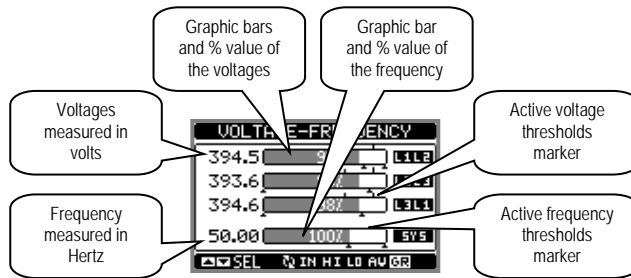

The next page displays an overview of the state of the Interface Protection System, showing both the state of the outputs to the IS and backup and the state of the control inputs. The black arrows indicate an active state, the grey ones an inactive state.

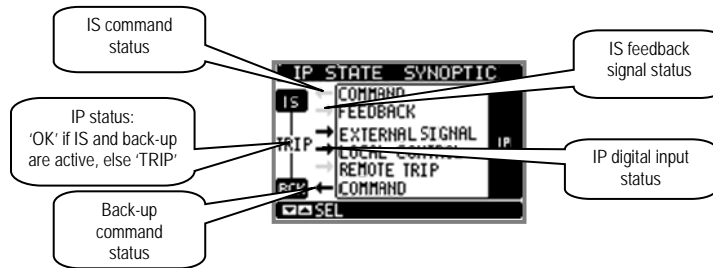

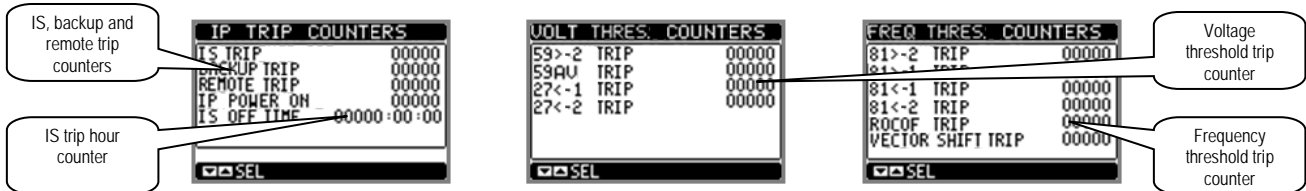

Three pages with trip protection counters follow, divided into total trip count, voltage threshold trip count and frequency threshold trip count. The counters can be reset through the Commands Menu.

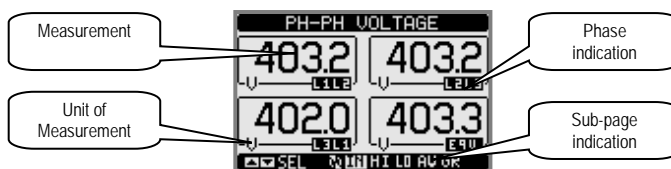

In the pages that follow these pages, on the other hand, the measurements are in standard numerical format.

Some measurements may not be displayed, depending on the programming and the connection for the device (for example, if programmed for a system without neutral, the measurements relating to neutral are not displayed).







- For many pages, the  button permits access to sub-pages (for example, to display the maximum and minimum values recorded).
- The sub-page displayed currently is indicated at the bottom left by one of the following icons:
  - **IN** = Instantaneous value – Current instantaneous value of the measurement, displayed by default every time the page is changed.
  - **HI** = Maximum instantaneous value – Highest value measured by the IP for the corresponding measurement. HIGH values are stored and preserved even in the absence of a power supply. They can be reset through a dedicated command (see COMMANDS MENU on page 8).
  - **AV** = Average value – Average value of the measurements, with slowed variations (average of the last minute).
  - **LO** = Minimum instantaneous value – Lowest value measured by the IP from the moment voltage is applied. It is reset with the same command used for the HI values.
  - **GR** = Graphic bars – Display of measurements through graphic bars.
- The user can specify the page and sub-page to return to automatically after no buttons have been pressed for a given time.
- It is also possible to program the PMVF 60 so that the display always remains that which was last selected.
- For the set-up of these functions, see MENU M02 – UTILITY on page 7.



I486 GB 06 20  
TABLE OF DISPLAY PAGES

No.	Selection via ▲ and ▼ PAGES	Selection via  SUB-PAGES			
		HI	LO	AV	GR
1	VOLTAGES, FREQUENCY V(L1-L2), V(L2-L3), V(L3-L1), F(Hz)	HI	LO	AV	GR
2	IP STATE OVERVIEW STATE OF IS/BACKUP CONTROL OUTPUTS, FEEDBACK INPUT, EXTERNAL SIGNAL, IP DISABLING INPUT, REMOTE TRIPPING				
3	VOLTAGE ACTIVE THRESHOLDS – DELAYS IN USE V THRESHOLDS AND DELAYS CURRENTLY ACTIVE				
4	FREQUENCY ACTIVE THRESHOLDS – DELAYS IN USE F THRESHOLDS AND DELAYS CURRENTLY ACTIVE				
5	IP TRIP COUNTER IS TRIP CNT, BACKUP TRIP CNT				
6	VOLTAGE THRESHOLD TRIP COUNTERS CNT 59-2, CNT 59-1, CNT 27-1, CNT 27-2				
7	FREQUENCY THRESHOLD TRIP COUNTERS CNT 81>-2, CNT 81>-1, CNT 81<-1, CNT 81<-2				
8	PHASE-TO-PHASE VOLTAGES V(L1-L2), V(L2-L3), V(L3-L1), V(LL)EQV	HI	LO	AV	GR
9	PHASE-TO-NEUTRAL VOLTAGES V(L1-N), V(L2-N), V(L3-N), V(L-N)EQV	HI	LO	AV	GR
10	MOVING AVERAGE VOLTAGE VM(L1-L2), VM(L2-L3), VM(L3-L1)	HI	LO		
11	PHASE AND NEUTRAL CURRENTS I(L1), I(L2), I(L3), I(N)	HI	LO	AV	GR
12	ACTIVE POWER P(L1), P(L2), P(L3), P(TOT)	HI	LO	AV	GR
13	ACTIVE POWER IMBALANCE kW P1-P2, kW P2-P3, kW P3-P1	HI	LO	AV	GR
14	TREND GRAPH P(TOT) LAST 24h				
15	ACTIVE ENERGY – ACTIVE POWER – BAR GRAPH kWh (TOT) – kW (TOT) – BAR GRAPH kW(TOT)				
16	REACTIVE POWER Q(L1), Q(L2), Q(L3), Q(TOT)	HI	LO	AV	GR
17	APPARENT POWER S(L1), S(L2), S(L3), S(TOT)	HI	LO	AV	GR
18	POWER FACTOR PF(L1), PF(L2), PF(L3), PF(TOT)	HI	LO	AV	GR
19	ENERGY METERS kWh+(TOT), kWh-(TOT), kvarh+(TOT), kvarh-(TOT), kVA(TOT)				PARTIAL
20	ENERGY METERS PHASE L1 kWh+L1(TOT), kWh-L1(TOT)				PARTIAL
21	ENERGY METERS PHASE L2 kWh+L2(TOT), kWh-L2(TOT)				PARTIAL
22	ENERGY METERS PHASE L3 kWh+L3(TOT), kWh-L3(TOT)				PARTIAL
23	EXPANSION MODULES				
24	INFO-REVISION-SERIAL NO. MODEL, REV SW, REV HW, SER. No.				
25	LOGO				

- **Note:** Some of the pages listed above may not be displayed, if the function displayed is not enabled. For example, if external CTs are not connected and programmed, the pages highlighted in grey are not displayed.
- **Note:** The moving average voltage measurement is not available for the first 10 minutes after switching on or resetting the system. During this time, dashes and a countdown indicating the time left before measurement display are shown.

## MAIN MENU

- The main menu consists of a set of graphic icons which allow rapid access to measurements and settings.
- Starting from the normal measurement display, press the **MENU** button. The display shows the quick menu (see figure below).
- Press **▲** or **▼** to select the desired function. The selected icon is highlighted and the message in the middle of the display indicates the description of the function.
- Press **↵** to activate the selected function.
- If some functions are not available, the corresponding icon will be deactivated, i.e. greyed out.
-      etc. – Operate as shortcuts which allow quicker access to pages for displaying measurements, going directly to the selected group of measurements, from which it is possible to move forwards and backwards as usual.

-  – Setting the numeric code which permits access to protected functions (setting parameters, executing commands).
-  – Parameter programming access point. See the Setting Parameters (set-up) section on page 5.
-  – Commands Menu access point, where recognized users can perform a number of resetting and restoring operations.

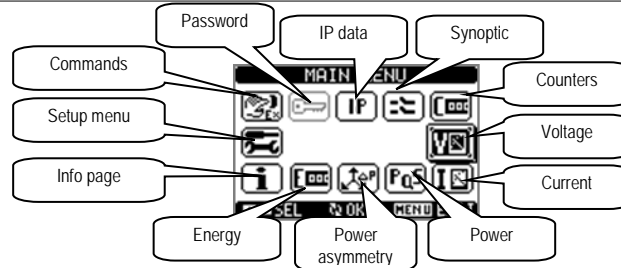

## PASSWORD-PROTECTED ACCESS

- For new (default) equipment, the password is enabled with the default 1000 (user access) and 2000 (advanced access) codes.
- To modify the access codes, refer to the Setting Parameters (set-up) section on page 5.
- There are two access levels, depending on the code entered:
  - **User-level access** – permits resetting of the recorded values and the display, but not changing, of the equipment's settings.
  - **Advanced-level access** – the same rights as user, with the addition of being able to change the settings.
- In the normal measurements display, press **MENU** to recall the main menu, then select the password icon and press **V**.
- The password setting window shown below will appear:



- Press the **▲** **▼** buttons to change the value of the selected digit.
- Press the **↵** button to confirm the digit and cycle to the next ones.
- Enter the password, then go to the key icon.
- When the password entered corresponds to the User-level or Advanced-level password, the appropriate unlock message appears.
- After the password is unlocked, access will remain enabled until:
  - the equipment is disconnected
  - the equipment is reset after exiting the Setting Parameters (set-up) menu
  - 2 minutes elapse without the operator touching any button.
- Press the **MENU** button to stop setting the password and exit.

## SETTING PARAMETERS (SET-UP)

- From the standard measurement display, press **MENU** to call up the main menu, then select the  icon and press **↵** to access the Setting Parameters (set-up) menu.
- The table in the figure is displayed, for selecting the set-up sub-menus, in which all the parameters are grouped according to their function.
- Press the **▲** **▼** buttons to select the desired menu and press **↵** to confirm.
- Press **MENU** to exit and return to the measurement display.
- The available sub-menus are listed in the following table:

Code	MENU	DESCRIPTION
M01	GENERAL	Specifications of the system
M02	UTILITY	Language, brightness, display pages, etc.
M03	PASSWORD	Enablement of protected access
M04	IP THRESHOLDS	IP trip thresholds and delays
M05	COMMUNICATION (COMn)	Communication ports
M06	ALARMS	Alarm enable

- Select the sub-menu and press the **↵** button to display the parameters.
- All parameters are displayed with code, description, current value.

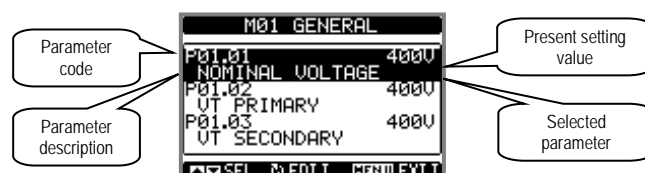

- To change the value of a parameter, select it then press **↩**.
- If the Advanced-level password has not been entered, it will not be possible to access the modification page, and an access denied message will be displayed.
- If access has been granted, on the other hand, the modification page will be displayed.

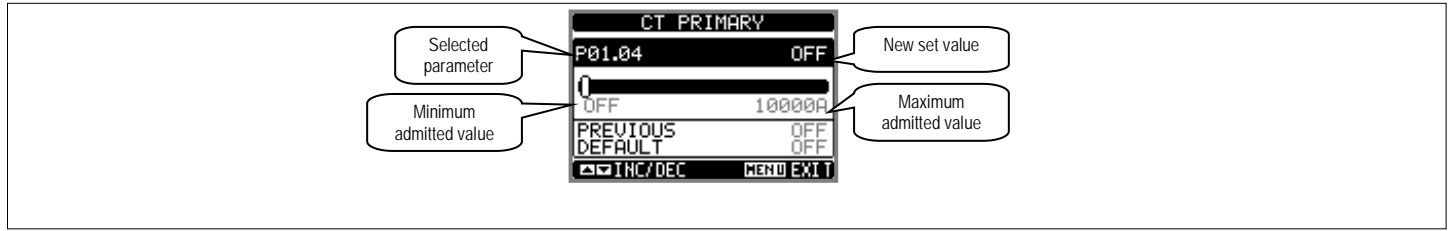

- In modification mode, the value can be changed with the **▲** and **▼** buttons. Also displayed are a graphic bar indicating the setting range, the minimum and maximum values possible, the previous value and the default value.
- Pressing **▲** and **▼** simultaneously restores the factory default value.
- Press **MENU** to return to parameter selection. The value entered is stored.
- Press **MENU** again to save the changes and exit set-up. The IP resets and resumes normal operation.
- **ATTENTION:** When restarting following a change to the parameters or commands, the output relays are temporarily de-energised.
- If no buttons are pressed for 2 minutes, the set-up menus are abandoned automatically and the IP returns to the standard display.

PARAMETER TABLE

M01-GENERAL		UoM	Default	Range
P01.01	Rated voltage	V	400	50 - 50000
P01.02	VT primary	V	400	50 - 50000
P01.03	VT secondary	V	400	50 - 500
P01.04	CT primary	A	OFF	OFF/1-10000
P01.05	CT secondary	A	5	1-5
P01.06	Voltage connection / control		Three-phase+N / VLL	Three-phase+N / VL-L Three-phase+N / VL-N Three-phase / VL-L Single-phase+N / VL-N
P01.07	Rated system power	kW	AUT	AUT/ 1-10000
P01.08	IS activation delay time after switching on IP	s	4,00	4,00 - 300,00
P01.09	Power imbalance limit LSP control output		OUT3	OFF OUT1 OUT3 OUT1 + OUT3
P01.10	LSP threshold 1	kW	6,0	OFF / 1.0 - 10.0
P01.11	LSP delay time 1	s	1800	1 - 3600
P01.12	LSP threshold 2	kW	10,0	OFF / 1.0 - 20.0
P01.13	LSP delay time 2	s	60	1 - 3600
P01.14	Automatic LSP restore time	min	5	OFF / 1- 60
P01.15	OUT4 output function		Global Alarm	OFF IS Backup LSP Global Alarm Threshold 59-1 Threshold 59-2 Threshold 27-1 Threshold 27-2 Threshold 81>-1 Threshold 81>-2 Threshold 81<-1 Threshold 81<-2 Alarm A01 Alarm A02 Alarm A03 Alarm A04 Alarm A05 Alarm A06
P01.16	Backup control mode		MODE A	OFF MODE A MODE B MODE C MODE D
P01.17	Backup control pulse duration	s	3,0	1,0 - 60,0

- P01.01 - Rated voltage
- P01.02 - Rated voltage of VT primary winding.
- P01.03 - V of VT secondary winding.
- P01.04 - Rated current of CT primary winding. If CTs are not fitted, leave at OFF. The pages on currents and powers are displayed only when CTs are used.
- P01.05 - Current of CT secondary winding.
- P01.06 - Type of connection and type of voltage control. Program in line with the wiring.
- P01.07 - Rated active power of system. If set to AUT, the value is calculated by multiplying P01.04 \* 230 \* 3 (phase current \* phase voltage \* 3 phases).
- P01.08 - IS recognized delay time after applying voltage to PMVF 60.
- P01.09 - LSP protection control output selection - On OUT1 (IS opening), independent on OUT3 or on both.
- P01.10-11 - First-level LSP (LSP1) threshold and delay.
- P01.12-13 - Second-level LSP (LSP2) threshold and delay.
- P01.14 - Defines the automatic restore time after LSP tripping. If set to off, the system can only be restored manually by pressing the **▲ ▼** buttons.
- P01.15 - Defines the function of the OUT4 output from those listed. The output is understood to be activated when conditions are normal (threshold not exceeded, alarm not active, etc.).
- P01.16 - Defines the backup control mode, according to the logic in the Backup Activation Modes diagram on the final pages of this manual. If the backup is not used, set to OFF.
- P01.17 - Backup opening pulse duration, when used in MODE C.

M02 – UTILITY		UoM	Default	Range
P02.01	Language		English	English Italiano
P02.02	LCD contrast	%	55	0-100
P02.03	Display backlighting intensity high	%	100	0-100
P02.04	Display backlighting intensity low	%	30	0-50
P02.05	Low backlight delay	s	30	5-600
P02.06	Default page return	s	60	OFF / 10-600
P02.07	Default page		IP MEASUREMENTS	IP – SYN – EVE ...
P02.08	Default sub-page		GR	IN / HI / LO / AV / GR
P02.09	Display update time	s	0,5	0,1 – 5,0

**P02.06** – If set to OFF, the display always remains on the page where the user left it. If set to a value, after this time the display returns to the page set with P02.07.

**P02.07** – Abbreviation for the start page on switching on and that the display returns to automatically once the time P02.06 since a button was last pressed has elapsed.

**P02.08** – Type of sub-page that the display returns to after P02.06 has elapsed.

M03 – PASSWORD		UoM	Default	Range
P03.01	Enable passwords		ON	OFF-ON
P03.02	User-level password		1000	0-9999
P03.03	Advanced-level password		2000	0-9999

**P03.01** – If set to OFF, password management is disabled.

**P03.02** – With P03.01 active, value to specify to activate user-level access. See Password-Protected Access section on page 5.

**P03.03** – As P03.02, with reference to Advanced-level access.

M04 – IP THRESHOLDS		UoM	Default	Range
P04.01	V MAX 59-2 (59>>) Threshold	%	115 (SHAMS) 120 (SEC)	100 – 130
P04.02	V MAX 59-1 (59>) Threshold	%	110	100 – 120
P04.03	V MIN 27-1 (27<) Threshold	%	85 (SHAMS) 90 (SEC)	20 – 100
P04.04	V MIN 27-2 (27<<) Threshold	%	40	0 – 100
P04.05	V MAX 59-2 (59>>) Delay	s	0,20	0,05 – 5,00
P04.06	V MAX 59-1 (59>) Delay	s	3,00	0,10 – 100,00
P04.07	V MIN 27-1 (27<) Delay	s	0,40	0,05 – 100,00
P04.08	V MIN 27-2 (27<<) Delay	s	0,20	0,05 – 5,00
P04.09	F MAX 81>-2 (81>>) Threshold	Hz	OFF (SHAMS) 62,5 (SEC)	OFF / 50,0 – 63,0
P04.10	F MAX 81>-1 (81>) Threshold	Hz	52,50 (SHAMS) OFF (SEC)	OFF / 50,0 – 63,0
P04.11	F MIN 81<-1 (81<) Threshold	Hz	47,50 (SHAMS) 57,5 (SEC)	OFF / 47,0 – 60,0
P04.12	F MIN 81<-2 (81<<) Threshold	Hz	OFF (SHAMS) 57,0 (SEC)	OFF / 47,0 – 60,0
P04.13	F MAX 81>-2 (81>>) Delay	s	0,10	0,05 – 5,00
P04.14	F MAX 81>-1 (81>) Delay	s	0,10	0,05 – 100,00
P04.15	F MAX 81<-1 (81<) Delay	s	4,00	0,05 – 100,00
P04.16	F MIN 81<-2 (81<<) Delay	s	4,00 (SHAMS) 0,10 (SEC)	0,05 – 5,00
P04.17	Backup energizing delay	s	0,5	0,1 – 10,0
P04.18	Local command		OFF	OFF – ON
P04.19	IP Restore delay	s	0,08	0,04 – 300,00
P04.20	Threshold type selection for 59-1 (59>)		59AV	59AV 59-1
P04.21	Threshold ROCOF 81R	Hz/s	OFF	OFF / 0,01 – 5,00
P04.22	Threshold Vector Shift 78	°	OFF	OFF / 1 – 50

**P04.01...P04.16, P04.20...P04.22** – Adjustment of trip thresholds and delay times defined by the standards.

**P04.17** – Maximum IS opening waiting time, before IS locking is recognized with consequent backup opening command (with P01.16 set to MODE A, MODE B or MODE C).

**P04.18** – Local control setting via parameter.

**P04.19** – IS restore (reset) time. IS reclosing delay time after all thresholds are ok again.



M05 – COMMUNICATION		UoM	Default	Range
P05.01	Serial node address		01	01-255
P05.02	Serial speed	bps	9600	1200 2400 4800 9600 19200 38400 57600 115200
P05.03	Data format		8 bit – n	8 bit, no parity 8 bit, odd 8 bit, even 7 bit, odd 7 bit, even
P05.04	Stop bits		1	1-2
P05.05	Protocol		Modbus RTU	Modbus RTU Modbus ASCII Modbus TCP
P05.06	IP address		000.000.000.000	000.000.000.000 – 255.255.255.255
P05.07	Subnet mask		000.000.000.000	000.000.000.000 – 255.255.255.255
P05.08	IP port		1001	0-9999
P05.09	Gateway function		OFF	OFF/ON

P05.01 – Serial address (node) for the communication protocol.

P05.02 – Communication port bitrate.

P05.03 – Data format. 7 bit setting position for ASCII protocol only.

P05.04 – Number of stop bits.

P05.05 – Communication protocol selection.

P05.06, P05.07, P05.08 – TCP/IP details for applications with Ethernet interface. Not used with other communication module types.

P05.09 – Gateway function enable.

M06 – ALARMS		UoM	Default	Range
P06.01	Alarm A01 enable		ON	ON – OFF
P06.02	Alarm A02 enable		ON	ON – OFF
P06.03	Alarm A03 enable		ON	ON – OFF
P06.04	Alarm A04 enable		ON	ON – OFF
P06.05	Alarm A05 enable		ON	ON – OFF
P06.06	Alarm A06 enable		ON	ON – OFF

P06.01...P06.06 – Enables or disables the corresponding alarm.

Note: The use of the auxiliary feedback contact on the I/S is recommended even in applications where the backup device is not used. If not even the feedback contact is used however, it will be necessary to deactivate alarm A03 by setting P06.03 to OFF.

#### COMMANDS MENU

- The Commands Menu is used to perform occasional operations, like resetting measurements, counters, alarms, etc.
- If the Advanced-level access password was entered, the Commands Menu can also be used to perform automatic operations useful for configuring the instrument.
- The following table shows the functions which are available with the Commands Menu, divided according to the required access level.

CODE	COMMAND	ACCESS LEVEL	DESCRIPTION
C.01	RESET HI-LO	User / Advanced	Resets the HI and LO values of all measurements
C.02	RESET TRIP COUNTERS	User / Advanced	Resets the trip counters
C.03	RESET PARTIAL ENERGY METERS	User / Advanced	Resets partial energy meters.
C.11	RESET TOTAL ENERGY METER	Advanced	Resets total and partial energy meters and tariffs
C.12	PARAMETERS TO DEFAULT 50Hz	Advanced	Restores all settings to factory default values for SHAMS DUBAI
C.13	PARAMETERS TO DEFAULT 60Hz	Advanced	Restores all settings to factory default values for SEC
C.14	PARAMETER BACKUP	Advanced	Saves a backup copy of the settings
C.15	PARAMETERS RESTORE	Advanced	Reloads the settings from the backup copy
C.16	TEST THRESHOLD 27-2	Advanced	Temporarily shifts threshold 27-1 to permit testing of threshold 27-2. See note below.
C.17	AUTOTEST	Advanced	PMVF60 performs the self test function according to the procedure described in the standard.

Note: The purpose of command C.16 is to permit testing of threshold 27-2 via relay test kit. This threshold is normally "covered" by 27-1 and consequently cannot be tested according to the procedures indicated by the standard. Giving this command sets threshold 27-1 temporarily to the minimum permitted value (20% Un), lower than the default value of 27-2 (40% Un) so as to permit it to be tested. This shift in the threshold lasts for a maximum of 5 minutes, during which the shifted value is visible on the Active Thresholds page. Switching the PMVF 60 off then on or waiting for the period to elapse (sufficient for performing the test) brings threshold 27-1 back to its normal set value.

#### AUTOTEST FUNCTION

- The autotest (self test) function performs the verification of the protective functions by increasing the lowest voltage and frequency thresholds and decreasing the highest voltage and frequency thresholds until the measured value by PMVF60 equals the thresholds themselves.
- The function is activated by C.17 command in the command menu.
- For each threshold the device will display the measured voltage and frequency values and tripping time by monitoring the feedback signal from the external contact of the switching device.
- In case of autotest failure, PMVF60 shows the cause which should be analysed and sorted out before repeating the test.
- DDI relay output command remains de-energized as long as the test has not been passed successfully.
- The auto test procedure will make PMVF60 trip many times within a short time: consider to manually disconnect the generating plant from the grid before executing the test.



## ALARM INDICATIONS

- In the event of an anomaly, the PMVF 60 indicates the situation with a pop-up window.
- If the user presses buttons on the front, the alarm is hidden temporarily to permit consultation of the screens.
- The alarm remains while the anomaly is present.

CODE	ALARM/INDICATION	DESCRIPTION / POSSIBLE CAUSES
A02	IS OPENING FAILURE	The IP sends the opening command to the IS, but the auxiliary (feedback) contact is closed, so the IP sends an opening command to the backup. Check the operation of the IS and of its auxiliary (feedback) contact.
A03	IS CLOSING FAILURE	<ul style="list-style-type: none"> <li>- The IP has ordered the closing of the IS but it does not close (check OUT1 wiring and/or IS coil).</li> <li>- The auxiliary IS contact (feedback) is not working.</li> <li>- The auxiliary IS contact (feedback) is not connected correctly to terminal INP1.</li> <li>- The auxiliary IS contact (feedback) is not fitted since it is not envisaged in the scheme.</li> </ul> Disable alarm A03 by setting P06.03 to OFF. Note: LOVATO Electric recommends the use of the feedback input.
A04	INCORRECT MODULE HW CONFIGURATION	PMVF 60 has not found the required expansion modules. Check that they are configured correctly at the side as in the figure on page 11.
A05	LSP1 TRIP - PRESS ▲ ▼ TO RESTORE	Power Imbalance Limit protection LSP1 has tripped. Automatic time-based or manual reset.
A06	LSP2 TRIP - PRESS ▲ ▼ TO RESTORE	Power Imbalance Limit protection LSP2 has tripped. Automatic time-based or manual reset.

- All the alarms/warnings except A04 are non-retentive, i.e. they reset when the anomaly is no longer present after the corresponding reset times.
- In the presence of a non-retentive alarm, the equipment continues to operate in any case.
- Exit OUT4 can be programmed to indicate the presence of any alarm (global alarm function).

## SELF-DIAGNOSIS

- The PMVF 60 features a series of self-diagnosis checks. If any of these checks is unsuccessful, a window displaying the text System Error Exx is displayed, where xx indicates the reason for malfunction. Should this indication occur, contact our Customer Service office (Tel. + 39 035 4282422; E-mail: service@LovatoElectric.com), stating the code indicated.

## CURRENT, POWER AND ENERGY MEASUREMENTS

- If CTs are connected to the current inputs and their reading is enabled by setting parameter P01.04 to a value other than OFF, the equipment will measure currents, powers and energies that, depending on where the CTs are positioned may refer to energy exchange (CTs positioned on the delivery point) or to the energy produced (CTs positioned on the genset line).
- The active power produced (exported, i.e. transferred to the grid) will be displayed with conventional minus sign (e.g. -6.5 kW). The quantity of energy produced by the genset will be added to the exported energy meter.

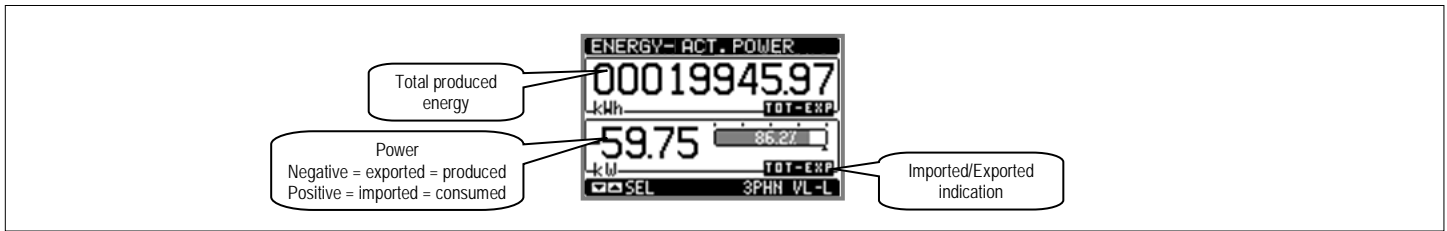

- There is also a page called Trend Graph which displays the trend in energy production in the last 24 hours (see below).

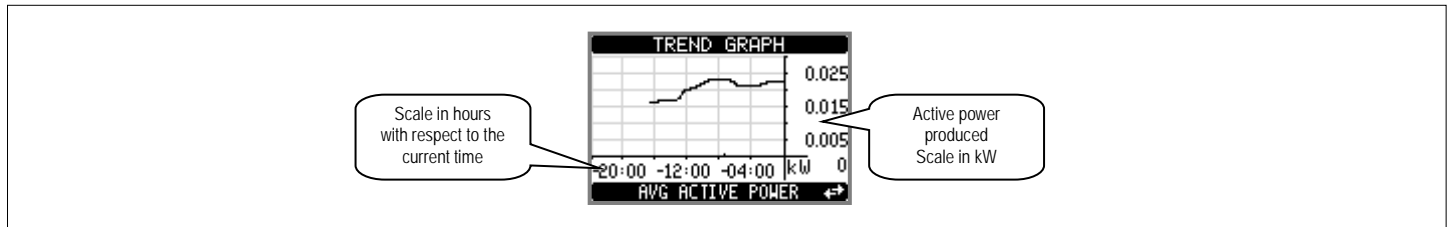

- The power measurements permit monitoring of the genset production parameters and making them available on the display or to any supervision system that can read them through one of the supported optional communication modules.

## POWER IMBALANCE LIMIT (LSP) CONTROL

- In three-phase+neutral systems, with CTs installed, the PMVF 60 can also be programmed to carry out the Power Imbalance Limit (LSP) function.
- In this case, when an imbalance is measured between the phase active powers (difference between the highest and lowest powers) of more than 6 kW for a time > 30 mins or an imbalance of more than 10 kW for a time > 1 min, LSP protection trips.

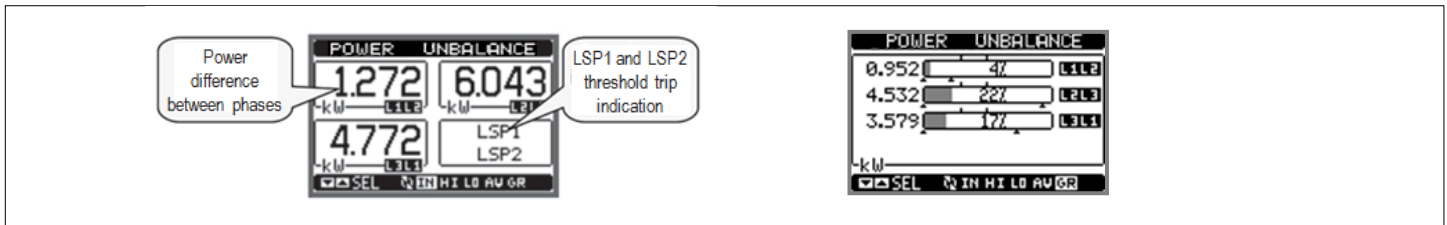

- This protection can be programmed to open relay OUT3 or to open the IS via output OUT1.
- See set-up parameters P01.09 to P01.14 (MENU M01 - GENERAL on page 6).
- LSP protection tripping is highlighted by A05 and A06 appearing on the display (for LSP1=6kW and LSP2=10kW imbalance thresholds respectively).
- It is possible to restore manually by pressing the ▲ ▼ buttons simultaneously, or automatically by waiting for the time set with P01.14.

COMMUNICATION

- The PMVF 60 can be fitted with an optional standard communication module from those listed below. When a communication module is installed, it must be configured through the dedicated M05 - COMMUNICATION MENU on page 8.
- The protocol currently supported is Modbus in the RTU, ASCII and TCP variants.
- The equipment is already prepared for communication in accordance with the IEC/EN 61850, possible via installation of a dedicated module.

MODULE TYPE	CODE	FUNCTION	MAX. No.
COMMUNICATION	EXM1010	USB	1
	EXM1011	RS232	
	EXM1012	RS485	
	EXM1013	ETHERNET	

CONNECTION SCHEMES

Three-phase connection with or without neutral P01.06 = Three-phase...

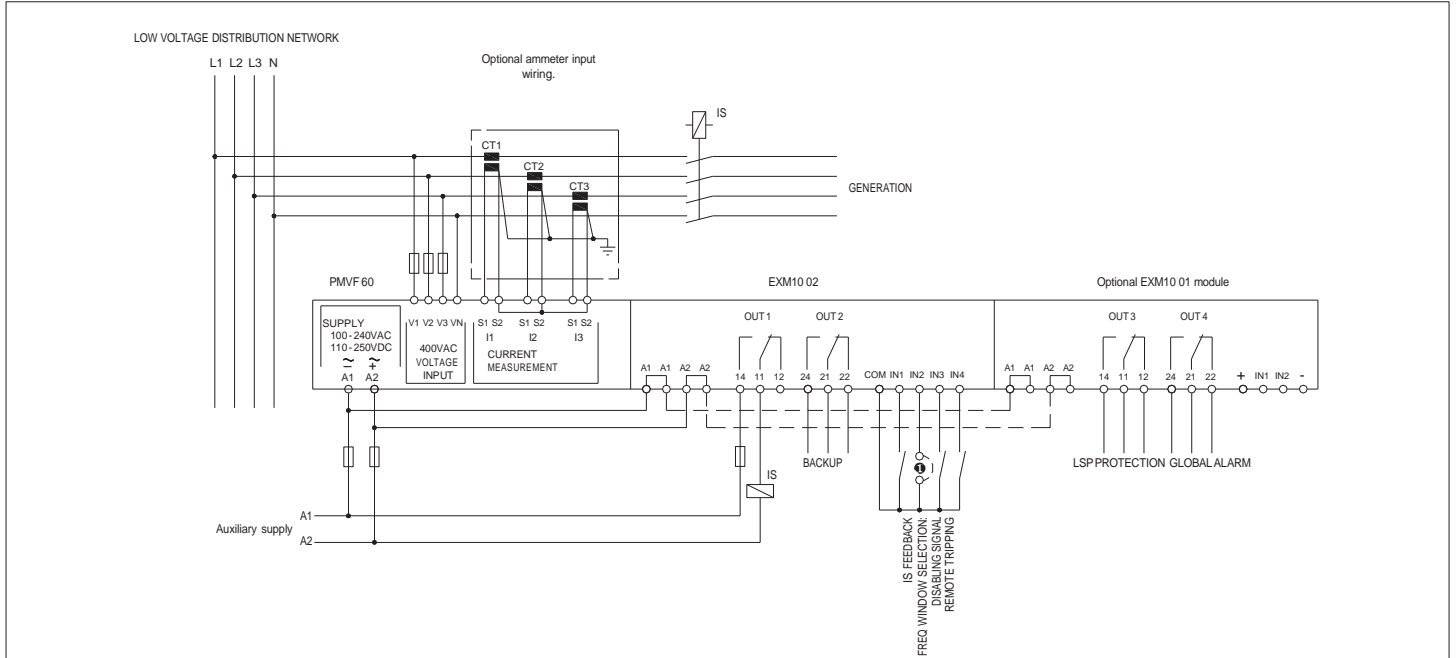

Single-phase connection (not applicable where PMVF 60 compliance with SHAMS DUBAI or SEC standards are required).  
P01.06 = Single-phase

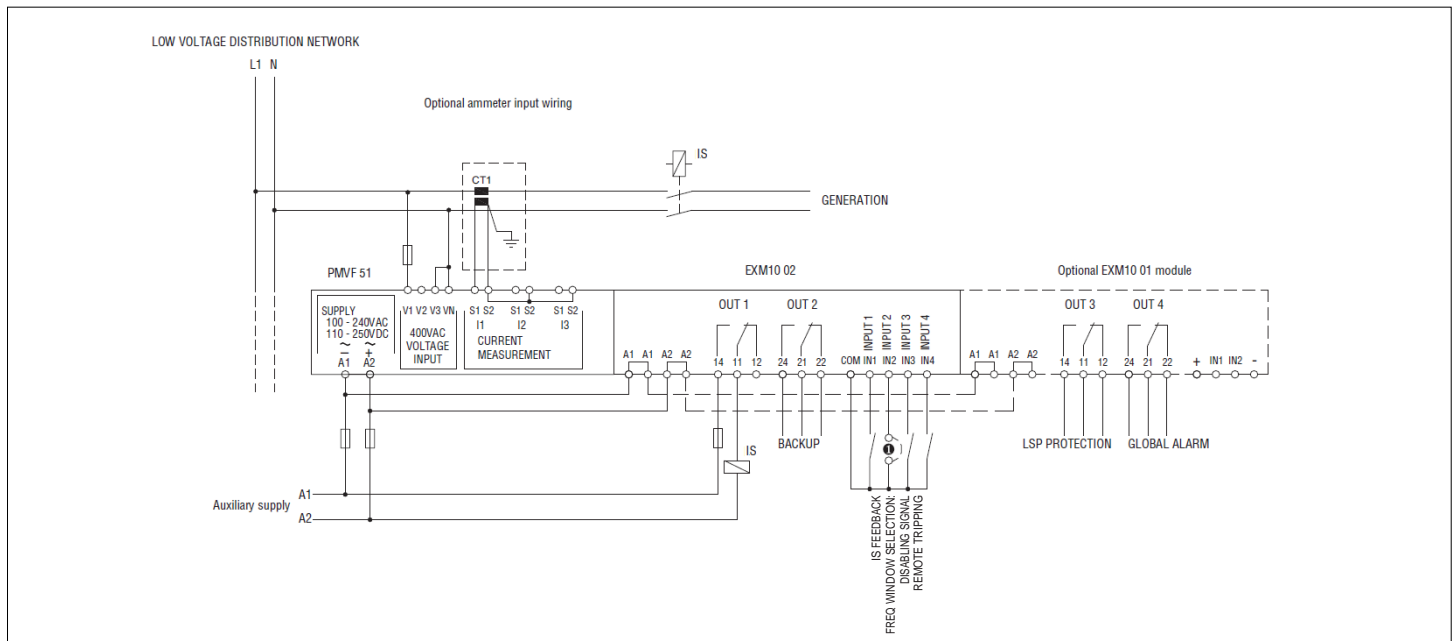

- Recommended fuses:  
Auxiliary supply and voltage measurement input: F1A (fast). Contactor control: MAX F5A (fast).
- The S2 terminals are connected to each other internally.
- The auxiliary IS contact (feedback) must of necessity be connected.
- In the case of multiple ISs, the IS feedback contact must be a parallel connection of all the ISs' auxiliary contacts.
- In single-phase wiring, connect terminal V3 to VN.

**ATTENTION:** terminals A1 and A1 of EXM modules are connected internally, as are terminals A2 and A2.  
The free A1 and A2 terminals can be used solely for supplying other EXM modules... (Max. 3). Maximum current 500mA.  
Maximum protection fuse current: F1A.

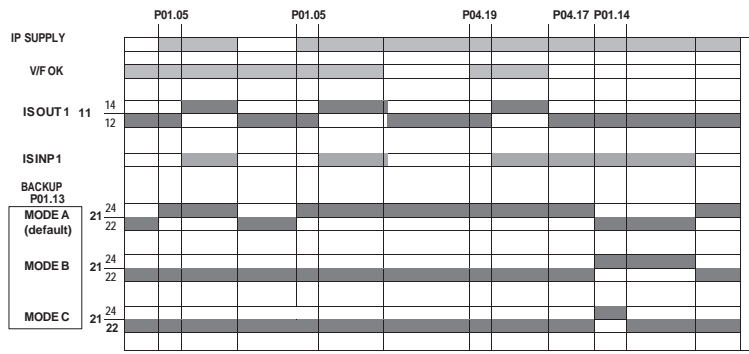

Note: The default backup control mode is A. If mode D is selected, Backup output mirrors the IS output. See parameter P01.16 (M01 - GENERAL MENU on page 6).

TERMINAL LAYOUT

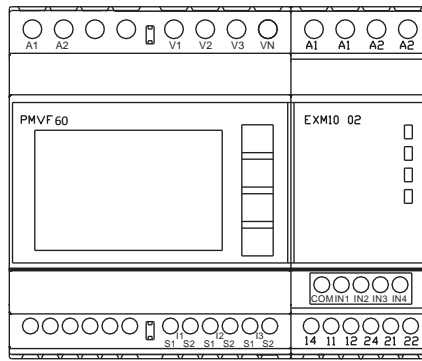

MECHANICAL DIMENSIONS[mm]

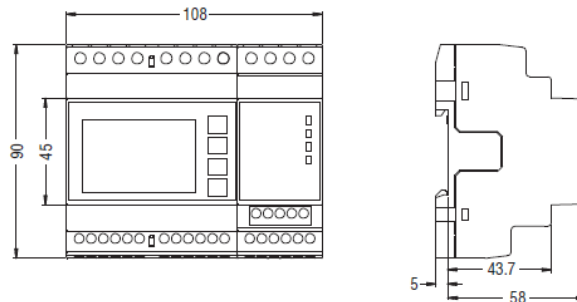

## TECHNICAL SPECIFICATIONS

**Auxiliary supply**

Rated voltage Us	100 - 240 V~ 110 - 250 V=
Operating range	85 - 264 V~ 93.5 - 300 V=
Frequency	45 - 66 Hz
Power consumption/dissipation	Us 110 V~ 4,6VA 2,5W max Us 230 V~ 12,5VA 2,7W max Us 110V= 23mA 2,3W max Us 250V= 11mA 2,5W max
Immunity time for microbreakings	≤200 ms with Us 240 VAC ≤50 ms with Us 100 VAC
Rated insulation voltage Ui	250 V-
Overvoltage category	II
Insulation	Testtype Uimp AC 50 Hz 4.8kV 2kV

**Voltmeter inputs**

Input type	Three-phase + neutral
Max. rated voltage Ue without VT	400 V- phase-to-phase 230 V- phase-to-neutral
Measuring range	20 - 480 V- phase-to-phase 10 - 276 V- phase-to-neutral
Rated frequency	50/60 Hz
Frequency range	45 - 66 Hz
Measurement type	True root mean square (TRMS)
Connection method	Three-phase with or without neutral
Rated insulation voltage Ui	400 V-
Overvoltage category	IV
Insulation	Testtype Uimp AC 50 Hz 7.3 kV 2kV

**Ammeter inputs (optional)**

Rated current Ie	1 A- or 5 A-
Measuring range	for 5 A scale: 0.010 - 6 A - for 1 A scale: 0.010 - 1.2 A -
Input type	Shunt supplied by an external current transformer (low voltage) 5 A max.
Measurement type	Root mean square (RMS)
Overload capacity	+20% In
Overload peak	50 A for 1 second
Burden (per phase)	≤0.6 W

**Accuracy**

Measuring conditions	
Temperature	+23°C ± 2°C
Phase voltage	±0.2% (160...480 V-) ±0.5 digit ±0.5% (50...160 V-) ±0.5 digit
Phase-to-phase voltages	±0.2% (277...830 V-) ±0.5 digit ±0.5% (80...277 V-) ±0.5 digit
Current	±0.2% (0.1...1.2 In) ±0.5 digit
Active energy	Class 0.5s (IEC/EN 62053-22)
Reactive energy	Class 2 (IEC/EN 62053-23)

**Additional errors**

Temperature	0.03%/°K per V, A, W
-------------	----------------------

**Relay outputs**

Number of outputs	2 
Output type	1 switching contact
Rated operating voltage	250 V-
IEC/EN 60947-5-1 designation	C300/ NO contact AC15A 250V - 5A 30V= NC contact AC12A 250V - 2A 30V=
Electrical endurance	NO contact 2x10 <sup>4</sup> operations NC contact 10 <sup>4</sup> operations
Mechanical life	10 <sup>7</sup> operations
Overvoltage category	II
Insulation	Testtype Uimp AC 50 Hz 4.8 kV 2kV

**Digital inputs**

Number of inputs	4
Input type	Positive (PNP)
Voltage present on inputs	12 V= isolated
Input current	7 mA
Low input signal (ON)	≤1.5 V (2.9 V typical)
High input signal (OFF)	≥5.3 V (4.3 V typical)
Rated insulation voltage Ui	12 V=

**Ambient conditions**

Operating temperature	-20 - +60 °C
Storage temperature	-30 - +80 °C
Relative humidity	<80% (IEC/EN 60068-2-78)
Maximum degree of ambient pollution	2
Altitude	≤2000 m

**Voltage measurement/power supply circuit connections**

Terminal type	Screw-type (fixed)
No. of terminals	2 + 4 for supply 4 for voltage measurement
Cable cross section (min. & max.)	0.2 - 4.0 mm <sup>2</sup> (24 - 12 AWG)
Tightening torque	0.8 Nm (7 lbin)

**Current measurement circuit connections**

Terminal type	Screw-type (fixed)
No. of terminals	6
Cable cross section (min. & max.)	0.2 - 2.5 mm <sup>2</sup> (24 - 12 AWG)
Tightening torque	0.44 Nm (4 lbin)

**Relay output connection**

Terminal type	Screw-type (fixed)
No. of terminals	6
Cable cross section (min. & max.)	0.2 - 2.5 mm <sup>2</sup> (24 - 12 AWG)
Tightening torque	0.44 Nm (4 lbin)
Isolation between the 2 relay outputs	Screw-type (fixed)

**Digital input connection**

Terminal type	Screw-type (removable)
No. of terminals	5
Cable cross section (min. & max.)	0.2...2.5 mm <sup>2</sup> (24 - 12 AWG)
Tightening torque	0.5 Nm (4.5 lbin)

**Housing**

Version	6 modules (DIN 43880)
Fitting	35 mm rail (IEC/EN 60715) or screw-type by means of clips removable
Material	Polyamide RAL 7035
Degree of protection	IP40 front IP20 housing and terminals
Weight	580 g

**Certifications and compliance**

Compliance with standards	SHAMS DUBAI - DRRG STANDARDS VERSION 2.0 SEC (Saudi Electricity Company) technical standard version 2.5
---------------------------	--

 Single insulation between the relays. Both the relay outputs must be used with the same voltage source.

