



- Single and three-phase energy meters
- MID certified versions with UTF certificates
- cULus certified versions
- Power analyzer and multifunction digital metering instruments, expandable, with icon display, monochrome or colour
- Digital voltmeters, ammeters, wattmeters, frequency meters and $\cos\phi$ meters
- Connection to single, two and three-phase and for power monitoring systems
- Ideal for distribution systems, electricity cogeneration and within machinery installations
- High measurement accuracy
- Totally programmable digital and analog inputs and outputs
- RS485, RS232, USB, Ethernet, Profibus DP and M-Bus communication ports.

	SEC. - PAGE
Energy meters	
Single-phase.....	25 - 12
Single-phase, MID certified	25 - 13
Three-phase with or without neutral	25 - 14
Three-phase with neutral, MID certified	25 - 15
Three-phase with neutral, with UTF certificates	25 - 16
Data concentrator	25 - 18
Power analyzers and EASY BRANCH power monitoring system	
Power analyzer with widescreen colour LCD	25 - 19
EASY BRANCH power monitoring system	25 - 20
Multifunction digital metering instruments	
Modular LCD multimeters	25 - 21
Flush-mount LCD multimeters	25 - 23
Digital metering instruments	
Modular LED measuring instruments	25 - 24
Flush-mount LED measuring instruments	25 - 26
Communication devices, protection covers, accessories	25 - 29
Converter, gateway, connecting cables	25 - 30
Current transformers	25 - 31
Dimensions	25 - 36
Wiring diagrams.....	25 - 39
Technical characteristics.....	25 - 42



Page 25-12

ENERGY METERS

- Single-phase, three-phase with neutral, three-phase with or without neutral
- Direct connection or by current transformers
- MID or cULus certified versions
- Versions expandable with EXM... expansion modules
- Versions with built-in RS485 or M-Bus communication ports.



Page 25-18

DATA CONCENTRATORS

- Energy consumption data storage for network usage
- Connection up to 14 energy meters equipped with static output
- Expandable with EXM... expansion modules
- Built-in RS485 communication port.



Page 25-19

POWER ANALYZERS WITH WIDESCREEN COLOUR LCD

- Widescreen colour LCD display
- Flush-mount 92x92mm
- Versions with built-in RS485 communication port
- Versions with built-in Ethernet and data memory
- Versions expandable with EXP... expansion modules
- NFC and optical port
- Compatibility with EASY BRANCH power monitoring system.



Page 25-21

DIGITAL LCD MULTIMETERS AND POWER ANALYZERS

- Graphic or icon LCD
- Modular and flush-mount 92x92mm
- Versions expandable with EXM... and EXP... expansion modules
- Version with built-in RS485 communication port.
- Flush-mount version with current reading through Rogowski coils.



Page 25-24

LED MEASURING INSTRUMENTS

- Voltmeters, ammeters and wattmeters
- Modular and flush-mount 96x48mm versions.



Page 25-31

CURRENT TRANSFORMERS

- Primary current: 5...4000A
- Secondary current: 5A
- Solid and split-core types
- Instrument and accuracy versions.
- Wound primary CT for low currents
- Busbar versions.

SINGLE-PHASE DIRECT CONNECTION

Type	DMED100T1	DMED110T1	DMED111	DMED112	DMED115T1	DMED120T1	DMED121	DMED122	DMED130LM
Maximum current	40A	40A	40A	40A	40A	63A	63A	63A	63A
Display									
Vertical, no backlight	●	●	●	●					
Horizontal, backlight					●	●	●	●	●
Measurements									
kWh	●	●	●	●	●	●	●	●	●
kWh, kW with average and max demand		●	●	●	●	●	●	●	●
kvarh, kvar, V, I, Hz, PF, total and partial hour counter		●	●	●		●	●	●	●
Interface									
Pulse output	●								
Programmable output (pulses/thresholds)		●			●	●			
Built-in Modbus-RTU (RS485)			●				●		
Built-in M-Bus				●				●	
MID version -25...55°C ^①	●	●	●	●		●	●	●	
MID version -25...70°C ^②			●						
Load management									●
Compatibility with Synergy, Synergy and Xpress software			●				●		

THREE-PHASE

Type	DMED300T2	DMED301	DMED302	DMED305T2	DMED330	DMED332	DMED310T2
Maximum current	80A	80A	80A	CT /5 or CT /1	CT /5 or CT /1	CT /5 or CT /1	CT /5
Connection type							
Direct	●	●	●				
Via CT				●	●	●	●
Interface							
Programmable output (pulses/thresholds)	●			●			●
Built-in Modbus-RTU (RS485)		●			●		
Built-in M-Bus			●			●	
Expandability							
Communication (RS485, Ethernet, USB)							●
Relay outputs for load disconnection							●
Data memory (Data logger)							●
MID version -25...55°C ^{①④}	●	●	●	●	●	●	●
MID version -25...70°C ^②		●					
cULus version (ANSI C12.20) ^③	●	●					
Compatibility with Synergy, Synergy and Xpress software		●			●		●

① For MID versions add "MID"

② For MID7 versions add "MID7"

③ For UL versions add "UL"

④ UTF certified versions available on request.

DIN RAIL MOUNTING (MODULAR)

Type	DMG100	DMG110	DMG200	DMG210	DMG300
Maximum rated voltage	600VAC	600VAC	690VAC	690VAC	690VAC
Voltage and current measure accuracy	0.5%	0.5%	0.5%	0.5%	0.2%
Active energy measure accuracy	Class 1	Class 1	Class 1	Class 1	Class 0.5s
Single-phase energy meter	●	●			
Harmonic analysis	15 th order	15 th order	THD only	THD only	31 st order
Boolean logic					●
Expandable with EXM... modules					3 modules
Display type	Icons	Icons	Graphic	Graphic	Graphic
Built-in communication port		RS485		RS485	
Communication port with EXM... modules					RS232 USB RS485 Ethernet
Ethernet-RS485 gateway function					●

FLUSH MOUNTING

Type	DMG600	DMG610	DMG611	DMG615	DMG620	DMG7000	DMG7500	DMG8000	DMG9000
Maximum rated voltage	600VAC	600VAC	600VAC	600VAC	600VAC	600VAC	600VAC	600VAC	600VAC
Current reading	CT /5A or CT /1A	CT /5A or CT /1A	Rogowski coils	CT /5A or CT /1A	CT /5A or CT /1A	CT /5A or CT /1A	CT /5A or CT /1A	CT /5A or CT /1A	CT /5A or CT /1A
Voltage and current measure accuracy	0.5%	0.5%	0.5%	0.2%	0.2%	0.2%	0.2%	0.2%	0.2%
Active energy measure accuracy	Class 1	Class 1	Class 1	Class 0.5s	Class 0.5s	Class 0.5s	Class 0.5s	Class 0.5s	Class 0.5s
Single-phase energy meter	●	●	●	●	●	●	●	●	●
Harmonic analysis	15 th order	15 th order	15 th order	15 th order	15 th order	63 rd order	63 rd order	63 rd order	63 rd order
Neutral-earth voltage									●
Neutral current	Calculated	Calculated	Calculated	Calculated	Calculated	Calculated	Calculated	Calculated	Measured
PLC logic						●	●	●	●
Display type	Icons	Icons	Icons	Icons	Icons	Colour graphic	Colour graphic	Colour graphic	Colour graphic
Built-in communication port		RS485	RS485	RS485	Ethernet		RS485	Ethernet	RS485 Ethernet
Expandable with EXP... modules	1 module	1 module	1 module	1 module	1 module	3 modules	3 modules	3 modules	3 modules
Communication port with EXP... modules	RS232 USB RS485 Ethernet	RS232 USB RS485 Ethernet	RS232 USB RS485 Ethernet	RS232 USB RS485 Ethernet	RS232 USB RS485 Ethernet	RS232 USB RS485 Ethernet Profibus DP	RS232 USB RS485 Ethernet Profibus DP	RS232 USB RS485 Ethernet Profibus DP	RS232 USB RS485 Ethernet Profibus DP
Data memory								●	●
Ethernet-RS485 gateway function						●	●	●	●
Energy quality according to EN 50160									●
Compatibility with EASY BRANCH power monitoring system							●	●	●
Degree of protection	IP54	IP54	IP54	IP54	IP54	IP65	IP65	IP65	IP65

● Coils and calibration report included.

POWER ANALYZERS WITH WIDESCREEN COLOUR LCD DMG SERIES



WIDESCREEN COLOR LCD
The large size of the colour LCD (4.3") allows for the optimal view of measures and parameters in a clear, simple and intuitive way.
The standard cutout dimensions (92x92mm) ensures a perfect compatibility with the usual front panel solutions.

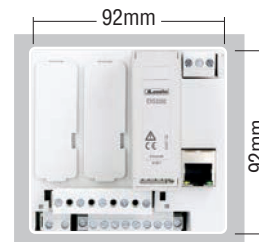

10 LANGUAGES
The language shown can be selected from a large number of choices: English, French, German, Italian, Spanish, Portuguese, Polish, Russian, Czech, Chinese.

PROGRAMMABLE LEDs
3 front LEDs are programmable and let the user know the status of the device at any time: alarms programmed by the user, status of digital inputs or outputs, emission of pulses indicating energy consumption, communication in progress.



HIGH ACCURACY LEVEL FOR MEASUREMENTS
The measurements are verified according to the recognized international standards for measuring instruments: IEC 62053-22 (class 0.5s), IEC 62053-24 (class 1) and IEC 61557-12 (class 0.5).

NFC CONFIGURATION
Thanks to NFC technology, it is possible to configure and modify parameters (even when the device is not powered) through **NFC LOVATO** App, which can be downloaded for free from the Google Play Store and App Store for Android and iOS smart devices.



PLC LOGIC
Thanks to the built-in PLC logic, the power analyzers can perform simple automations related to timers and alarm states and digital inputs. Programming with "contacts" (**Ladder**) is simple and intuitive thanks to the use of **Xpress** configuration software.

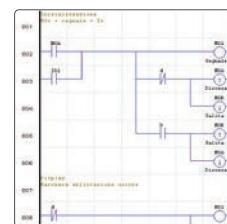

	DMG7000	DMG7500	DMG8000	DMG9000
Built-in RS485 port	-	●	-	●
Built-in Ethernet port (with web-server)	-	-	●	●
Ethernet-RS485 gateway function	+ EXP1012 + EXP1013	+ EXP1013	+ EXP1012	●
Memory for data collection	-	-	●	●
Statistics of network quality according to EN50160	-	-	-	●
Neutral current measurement through dedicated CT	-	-	-	●
Neutral-Earth voltage measurement	-	-	-	●
Compatibility with EASY BRANCH power monitoring system	-	●	●	●

EVERYTHING UNDER CONTROL!

MEASUREMENTS
DMG power analyzers display all the measurements useful for a complete check of the electrical network. The voltage measurement input does not require external transformers **up to 600VAC**.

CHARTS AND HARMONICS
The electrical measurements are shown with waveform charts, polar diagrams and representations of the **harmonic spectrum up to the 63rd order** which is a useful tool to better understand the state of the system.

STATISTICS
The DMG9000 model also provides statistics on the quality of the network according to the **EN50160** standard - class C - (voltage dips, overvoltages, interruptions, low frequency noises and much more).

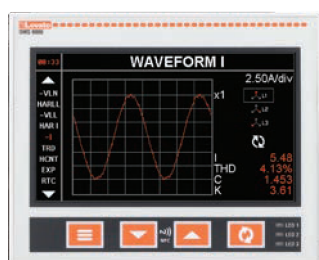

Waveforms

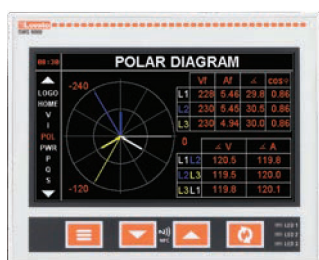

Polar diagram



Currents

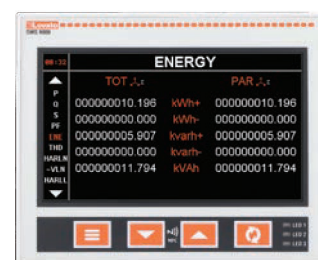

Energy consumption control

EXPANDABILITY AND COMMUNICATION

● **EXPANDABILITY**

Possibility to add **up to 3** EXP... series expansion modules (additional inputs, outputs and communication ports).

● **INTEGRATION WITH SIGNALS FROM THE FIELD**

Thanks to the EXP... expansion modules it is possible to add **digital and analog inputs** by which field measurements such as gas or water consumption, tank levels, temperatures, pressures and much more are integrated into the data collection in order to obtain a complete energy management.

● **OPTICAL PORT**

The optical port compatible with the communication devices CX01 and CX02 is available and allows, thanks to **Xpress** software, the parameter configuration, the electrical network diagnostics and the firmware update of the power analyzer.

● **DEGREE OF PROTECTION: IP65**

Possibility of use in harsh environments thanks to the gasket on the back which guarantees the **IP65** degree of protection.

● **COMMUNICATION**

Availability of models with built-in **RS485** and **Ethernet** communication ports.

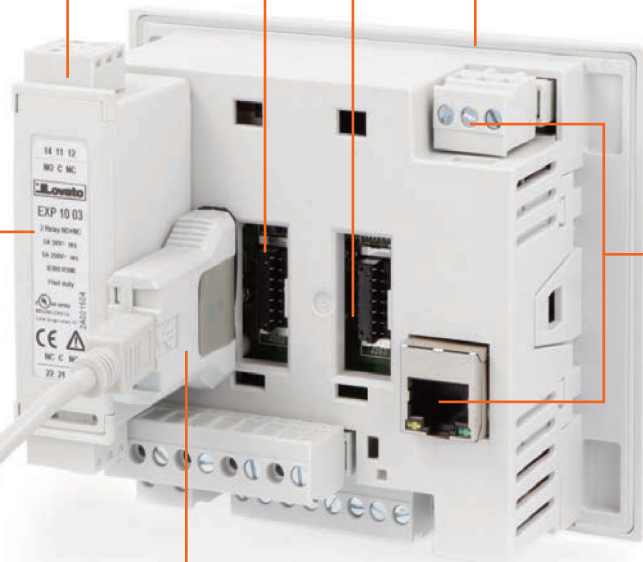

● **EASY BRANCH POWER MONITORING SYSTEM**

Thanks to the EXS... modules, a simplified and very fast wiring can be achieved in panels where it is necessary to read the electrical parameters of different loads, drastically reducing the costs and the installation times.



WEB-SERVER FUNCTION IN DMG8000 AND DMG9000



● **SETTING OF ALL PARAMETERS**

The programming of the parameters, as well as from the front panel, can also be done through the browser on a PC. The built-in web-server also allows the setting of the parameters of the EASY BRANCH power monitoring system, such as the descriptions of the individual measurement points.

● **WEBSERVER AND BUILT-IN DATA MEMORY**

A flash data memory allows archiving of historical data. Through the built-in webserver the user can:

- select the measures (up to 128);
- set the sampling frequency;
- download the .CSV file with the acquired informations.

For example, by sampling 20 measurements with 1 minute of sampling time, 10 days of data can be stored.

● **MEASUREMENT VIEW**

Representation of the measured values by means of tables and charts.

EASY BRANCH POWER MONITORING SYSTEM

When inside an electrical panel the parameters of several loads have to be monitored, **EASY BRANCH** power monitoring system is a more efficient and simple alternative solution to install than the traditional one which requires an independent instrument for each measuring point. The electrical distribution panels in shopping centres or in the departments of a production facility represent ideal applications for **EASY BRANCH** system by LOVATO Electric.

SYSTEM COMPONENTS



DMG7500 - 8000 - 9000
Power analyzer

● **DMG7500, DMG8000, DMG9000 power analyzers.**

The power analyzers represent the heart of the system: they measure the electrical voltage in the switchboard and the input current, record the total measurements upstream of the distribution and the measurements of each individual monitored load available on their display. The electrical quantities can also be viewed via the built-in communication ports (RS485 or Ethernet).



On the **DMG8000** and **DMG9000** models, the system measurements can be viewed within a web page and can be recorded in the data memory to get historical trends.



EXS0000
Bus module

● **EXS0000 bus module**

Installed in one of the expansion slots of the power analyzer, by using a standard Ethernet cable (cat.6) it connects and supplies **up to 8 current measuring modules EXS4...** which are automatically recognized without the need for settings by the installer.

When connecting 5 or more EXS4 current modules ... the **EXS0000** bus module requires a 24VDC - 0.2A power supply.

MAX 8 EXS4... current measuring modules can be connected to the EXS0000 bus module, to monitor up to:

- 33 three-phase loads;
 - 99 single phase loads.
- Including the loads connected to the power analyzer.

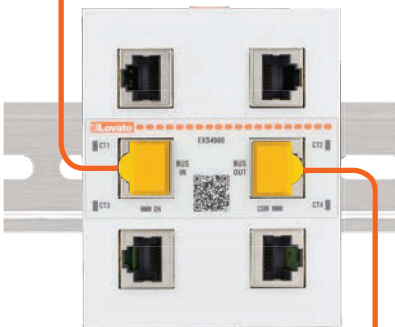

EXS4000
Current measuring module with 4 inputs for electronic RJ45 CTs

● **Current measuring module EXS4000**

The module collects the measurements of the loads monitored by the electronic current transformers EXS3... (three-phase or single-phase) or EXS1... (single-phase). Each module measures **up to 4 three-phase loads or 12 single-phase loads** or a mixed single-phase and three-phase configuration. The module automatically recognizes the connected electronic current transformer and highlights, through diagnostic LEDs, the correct self-configuration of the measurement points and the correct coupling with the power analyzer.



Correct self-configuration LED

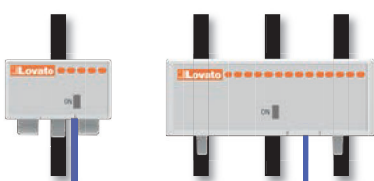

EXS1... - EXS3...
Electronic current transformer

● **Electronic current transformers EXS1... and EXS3...**

They are current transducers suitable to be installed immediately downstream of the magnetic circuit breakers thanks to their compact size. Available **for single-phase or three-phase loads**, the diameter and pitch of the pass-through holes have been designed to be in line with the ones of the MCBs:

- for sizes up to 63A: $\varnothing = 7\text{mm}$ and 18mm pitch;
- for sizes up to 125A: $\varnothing = 12\text{mm}$ and 27mm pitch.

They connect to the EXS4000 current monitoring module via pre-wired **2 meter RJ45 cable**, thus making the connection fast and fail-safe.

EXS3 ... can be programmed to manage even single-phase loads.

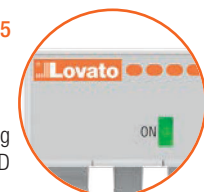

Correct coupling signalling LED



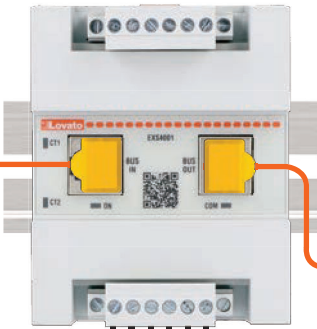

● **Current measuring module EXS4001**

It offers the possibility of connecting monitored measuring points with traditional current transformers within the EASY BRANCH system, managing for each module **up to 2 three-phase loads or 6 single-phase loads** or a mixed single-phase and three-phase configuration. Current transformers of any type with secondary /5A or /1A can be used. The module highlights the successful coupling with the power analyzer through diagnostic LEDs.



Correct coupling signalling LED

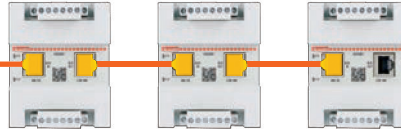

EXS4001

Current measuring module with 2 inputs for three-phase traditional CTs or 6 inputs for single-phase traditional CTs

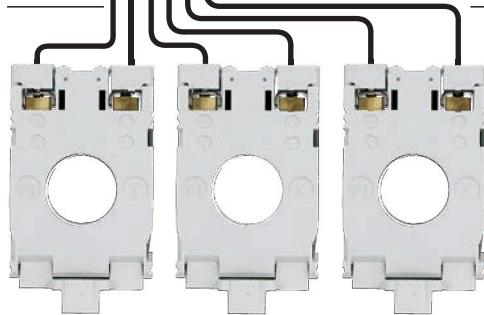

DM...
Current transformers

● **Traditional current transformer DM...**

Current transformers (CTs) type DM... are mounted in an electrical system to reduce the line current to a secondary value of 5A and compatible with EXS4001 current measuring modules.

They are available in many versions:

- with wire-wound primary for reduced currents;
- solid core type;
- high precision for very accurate measurements;
- split-core and pre-wired types which are suitable for updating the panels;
- **primary current from 5 to 4000A.**

● **Gateway data logger**

A gateway data logger is the key device for the implementation of a modern and well-designed energy monitoring system.

It collects data from LOVATO Electric devices or from environmental sensors relating to any type of energy carrier (water, air, gas, electricity and steam) equipped with a compatible protocol.

The data collected, as well as being represented by the integrated web-server, can be transmitted to **Synergy** supervision software of LOVATO Electric or forwarded to remote servers in formats suitable for appropriate processing.



EXCGLA01
Gateway data logger

● **Supervision software**

All the data of the EASY BRANCH system are available on the central power analyzer and, through its communication ports, it is possible to collect them remotely by connecting directly with a browser if the model chosen is DMG8000 or DMG9000, or through **Synergy** software installed on a local server, or using **Synergy** Cloud if the gateway data logger EXCGLA01 is added to the system.



SYNERGY
Supervision software

EASY BRANCH PLUG & PLAY SYSTEM ADVANTAGES

● **4 COMPONENTS NEEDED**

The EASY BRANCH system consists of a few elements to add to the power analyzer: EXS0000 module to get the communication bus, the EXS4... module to measure currents and the EXS1..., EXS3 electronic current transformers... or traditional /5A or /1A CTs.

Up to 33 three-phase or 99 single-phase measuring points can be obtained!

● **DRAMATIC REDUCTION OF WIRING TIMES**

In a monitoring system with traditional measuring instruments, 4 voltage and 6 current cables are required for each three-phase measuring point and two additional cables for the auxiliary power supply are added: a total of 12 cables to be connected for each measuring point.

With the EASY BRANCH system, for each additional current measuring module (EXS4000) only one cable with RJ45 terminal must be connected, getting 4 three-phase or 12 single-phase measurement points, each of which is connected with a cable with RJ45 terminal, drastically reducing the wiring time.

● **STOP TO WIRING MISTAKES!**

In a monitoring system with traditional measuring instruments, 12 cables to be connected for each three-phase measuring point can cause various wiring errors (phase sequence, phase correspondence between voltages and currents, current transformers sense) which cause errors in reading the electrical quantities and delay the commissioning of the switchboard. The EASY BRANCH system, thanks to the **RJ45** connections of the electronic CTs, is foolproof!



● **SETTING TIME REDUCTION**

EXS1... and EXS3... electronic transformers have a **self-recognition** system with the current module to which they are connected, avoiding the installer the need to set the CT primary and the type of connection (single-phase, three-phase). A LED on the electronic transformers indicates the correct power supply, while a LED on EXS4000 current measuring module indicates the correct coupling.

● **NO SPECIAL CABLES NEEDED**

No special cable is needed to connect the current measuring modules to EASY BRANCH bus: **a standard Cat.6 Ethernet cable is enough.**

● **COMPARISON BETWEEN EASY BRANCH AND TRADITIONAL MEASURING SYSTEMS**

If 5 three-phase loads are to be monitored in an electrical panel:

- **EASY BRANCH SYSTEM:** 1 power analyzer, 1 display where to search for measurements, 1 EXS0000 bus module, 1 EXS4000 current measuring module, 4 three-phase electronic transformers and only 12 cables to be wired
- **TRADITIONAL SYSTEM:** 5 multimeters, 5 displays where to search for measurements, 15 current transformers and 60 cables to be wired.

The more the measuring points increase, the more the advantages in favour of the EASY BRANCH system are evident.

● **MEASUREMENT ACCURACY**

The EASY BRANCH system guarantees high measurement accuracy according to IEC61557-12 and IEC62053-22/23 standards.

PLANT MANAGEMENT WITH EASY BRANCH

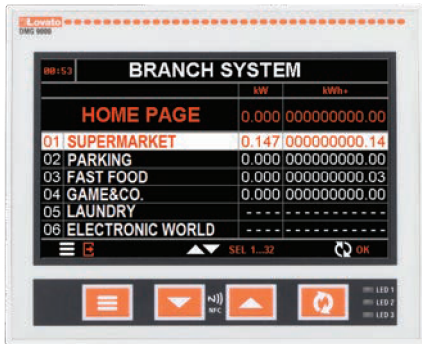

DMG7500 - 8000 - 9000
Power analyzer



EXS0000
Bus module for EASY BRANCH system



EXS1080
80A single-phase electronic current transformer with RJ45 cable, 2m long

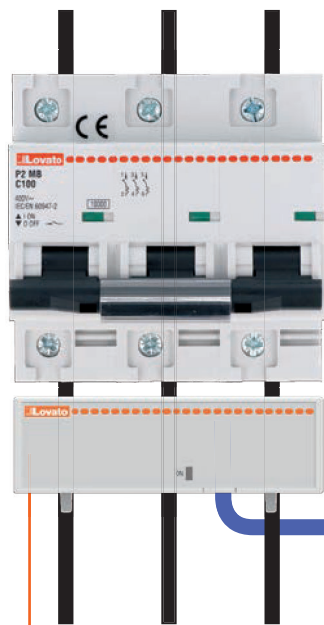

EXS3125
125A three-phase electronic current transformer with RJ45 cable, 2m long

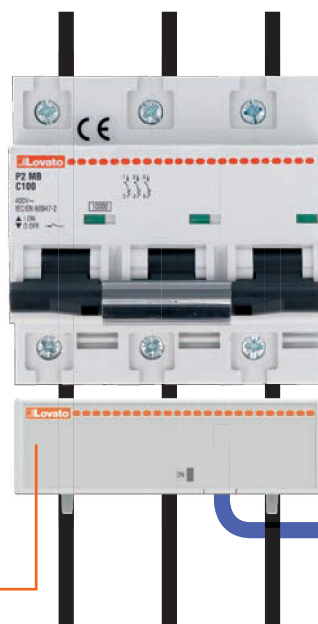

EXS3080
125A three-phase electronic current transformer with RJ45 cable, 2m long

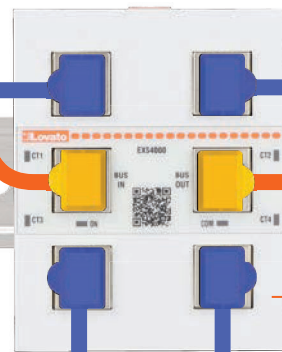

EXS4000
Current measuring module with 4 inputs for electronic RJ45 CTs



EXS3063
63A three-phase electronic current transformer with RJ45 cable, 2m long

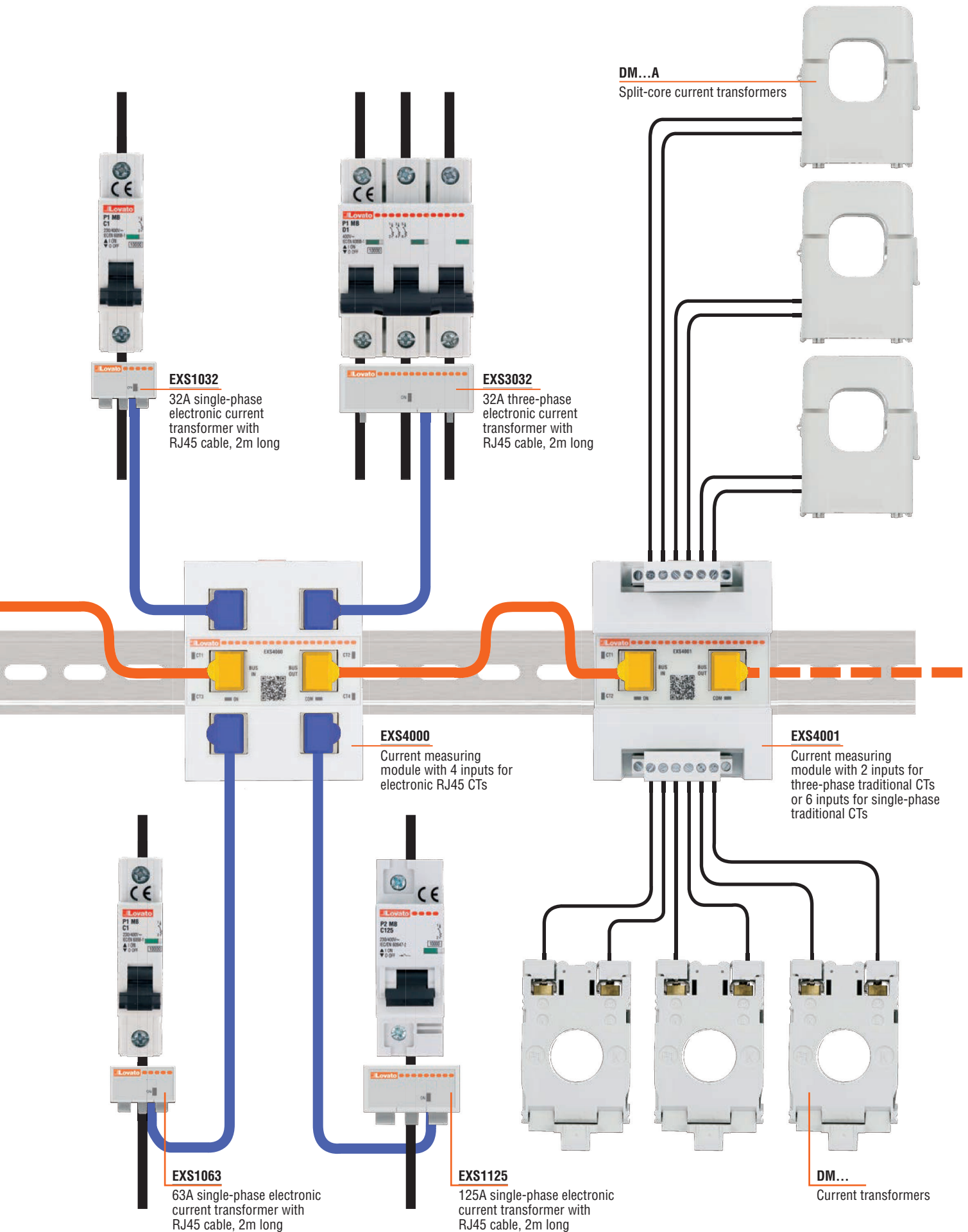

ENERGY MANAGEMENT SOLUTION BY LOVATO ELECTRIC

For the purpose of monitoring and energy saving, LOVATO Electric provides a complete and integrated solution consisting of:

- **hardware devices** for energy measurement and control (power analyzers, multimeters, energy meters, variable speed drives, soft starters, automatic power factor controllers, gateway data loggers, etc.);
- webserver **software** to continuously monitor energy vectors via the Web.

Synergy by LOVATO Electric is an energy monitoring and analysis system with a professional, flexible and integrated approach from an Industry 4.0 perspective. Thanks to the LOVATO Electric **measurement devices** equipped with a communication port and through the web-based supervision platform, it is possible to monitor real time measurements, consult graphics, receive alarms, export customized reports and carry out commands and settings.

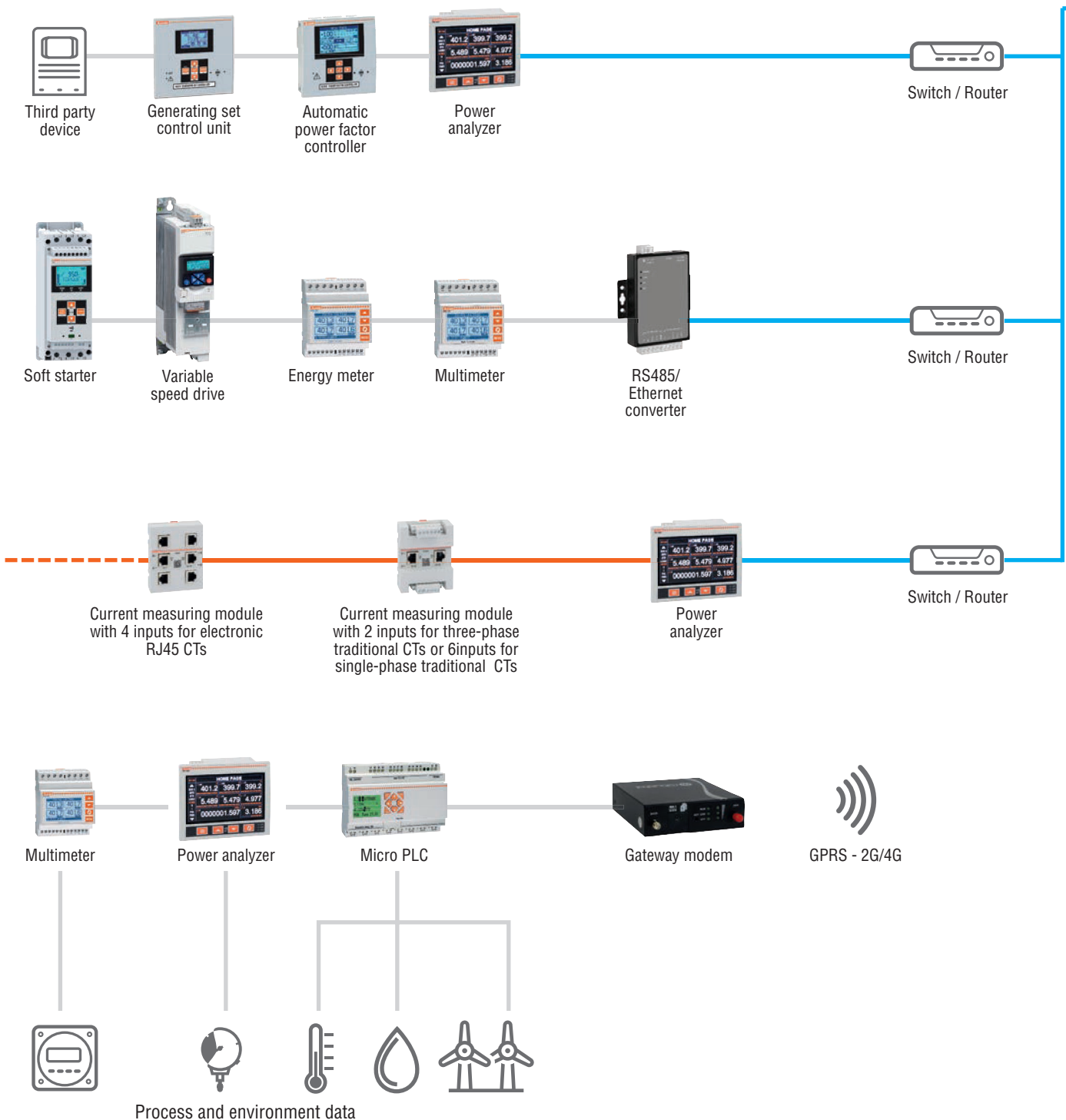

GATEWAY DATA LOGGER LOCAL WEBSERVER

LOVATO Electric **EXCGLA01** gateway data logger provides access to an integrated webservice which allows local consultation of the monitored data and acts as a gateway to **Synergy** supervision software.



Gateway data logger

Built-in webservice information view



Pre-defined live pages, charts and data logs

MONITORING AND SUPERVISION SOFTWARE

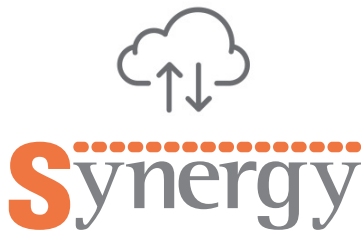

Synergy is a software which can be completely customized by the user who can thus have the key indicators of the monitored systems, be notified in the event of alarms for anomalies in consumption and monitor performance over time. It is open to the integration of third-party instrumentation thanks to the use of the MODBUS communication protocol and the ability to integrate any device equipped with analog or digital output.

Multi-device



Laptop



Tablet



Smartphone

Multi-users



Administrators



Powerusers



Users



Customizable Dashboard, Data Log and Reports

Single-phase



DMED110T1...
DMED110T1A120
DMED111
DMED112

new



DMED115T1...
DMED120T1...
DMED121 - DMED122

Order code	Description	Qty per pkg	Wt
		n°	[kg]
Digital meter, with LCD screen.			
DMED100T1	40A direct connection, 1U 1 pulse output, 220...240VAC	1	0.086
DMED100T1A120	40A direct connection, 1U 1 pulse output, 110...120VAC	1	0.086
DMED110T1	40A direct connection, 1U 1 program. static output, multi-measurements①, 220...240VAC	1	0.090
DMED110T1A120	40A direct connection, 1U 1 program. static output, multi-measurements①, 110...120VAC	1	0.090
DMED111	40A direct connection, 1U, RS485 interface multi-measurements①, 110...240VAC	1	0.090
DMED112	40A direct connection, 1U, M-Bus interface multi-measurements①, 110...240VAC	1	0.090
Digital meter with backlight LCD display.			
DMED115T1	40A direct connection, 2U, 1 program. static output, multi-measurements ②, 220-240VAC	1	0.090
DMED120T1	63A direct connection, 2U 1 program. static output, multi-measurements ①, 220-240VAC	1	0.148
DMED120T1A120	63A direct connection, 2U 1 program. static output, multi-measurements①, 110...120VAC	1	0.148
DMED121	63A direct connection, 2U, RS485 interface multi-measurements①, 110...240VAC	1	0.148
DMED122	63A direct connection, 2U, M-Bus interface multi-measurements①, 110...240VAC	1	0.148

Order code	Description	Qty per pkg	Wt
		n°	[kg]
Digital meter with backlight LCD display per load management.			
DMED130LM	63A direct connection, 4U, multi-measurement①, 2 inputs and 2 relay outputs for load management, 220...240VAC	1	0.300

Single-phase Load management



DMED130LM

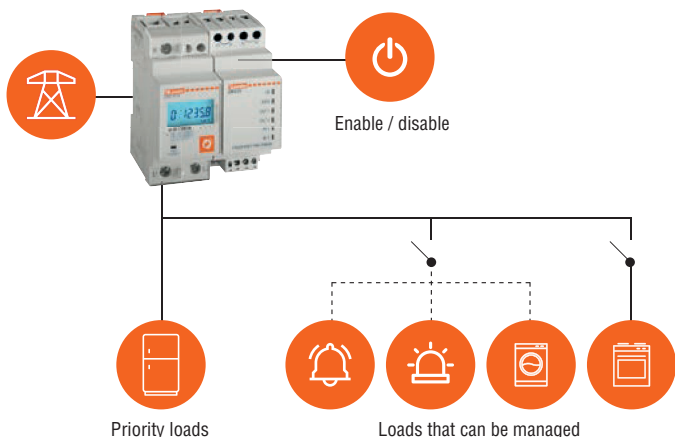

General characteristics

The energy meters are instruments for energy consumption measurement in single-phase installations with direct connection.

Operational characteristics

- LCD meter: with 5+1 digit count for DMED100T1..., DMED110T1..., DMED111, DMED112; backlight with 6+1 digit count for DMED115T1, DMED120T1..., DMED121, DMED122, DMED130LM
- Direct connection
- Active energy measurement and accuracy: Class 1 (IEC/EN/BS 62053-21)
- Reactive energy measurement and accuracy: Class 2 (IEC/EN/BS 62053-23)
- Metrological LED with pulse emission for consumption indication
- Clearable partial energy measurement
- Built-in RS485 or M-Bus ports for pulse output models (except DMED130LM) compatible with Synergy and Xpress
- Modular housing: 1 module for DMED100T1, DMED110T1, DMED111 and DMED112; 2 module for all other types
- Sealable terminal blocks, standard supplied
- EN degree of protection: IP40 on front; IP20 at terminals.

Synergy supervision and energy management software See Section 30.

Xpress configuration and remote control software See Section 30.

EXM series expansion modules See page 31-3.

Certifications and compliance

Certifications obtained: cULus (DMED100..., DMED110..., DMED120..., DMED121), EAC (for all DMED... type), RCM (for all DMED...type, DMED122 except). Compliant with standards: IEC/EN/BS 50470-1, IEC/EN/BS 61010-1 per tipi DMED....; UL 61010-1, CSA C22-2 n° 61010-1 for DMED100..., DMED110..., DMED120..., DMED121.

① Multi-measurements:

- Total and partial active energy
- Total and partial reactive energy
- Voltage
- Current
- Active and reactive power
- Power factor
- Frequency
- Total and partial hour counter
- Average active power (calculation made using the last 15 minutes of data)
- Maximum demand.

② Multi-measurements:

- Total and partial active energy
- Active power
- Average active power (calculation made using the last 15 minutes of data)
- Maximum demand.

Single-phase, MID certified

MID



DMED110T1MID
DMED111MID
DMED112MID



DMED111MID7



DMED120T1MID
DMED121MID
DMED122MID

new

Order code	Description	Qty per pkg	Wt
		n°	[kg]
Digital meter with LCD display.			
DMED100T1MID	40A direct connection, 1U 1 pulse output, 230VAC	1	0.090
DMED110T1MID	40A direct connection, 1U 1 programmable static output, multi-measurements ①, 230VAC	1	0.090
DMED111MID	40A direct connection, 1U, RS485 interface, measurements ①, 230VAC	1	0.090
DMED111MID7	40A direct connection, 1U, RS485 interface, measurements ①, 230VAC, -25...+70°C	1	0.090
DMED112MID	40A direct connection, 1U, M-Bus interface, measurements ①, 230VAC	1	0.090
DMED120T1MID	63A direct connection, 2U 1 programmable static output, multi-measurements ①, 230VAC	1	0.152
DMED121MID	63A direct connection, 2U, RS485 interface multi-measurements ①, 230VAC	1	0.148
DMED122MID	63A direct connection, 2U, M-Bus interface multi-measurements ①, 230VAC	1	0.148

General characteristics

The DME... series energy meters, MID certified, are needed for billing purposes between electricity suppliers and consumers and for energy consumption measurement in directly connected single-phase installations. MID is the Measuring Instruments Directive of the European Union; instruments must be certified accordingly whenever used for monetary transactions in this territory.

Operational characteristics

- LCD meter: DMED100/110/111/112T1MID; backlight with 6+1 digit count for DMED120/121/122MID
- Direct connection
- Active energy measurement and accuracy: Class B (EN 50470-3)
- Reactive energy measurement and accuracy: Class 2 (IEC/EN/BS 62053-23)
- Metrological LED with pulse emission for consumption indication
- Clearable partial energy measurements
- One output: pulse for DMED100T1MID; programmable static for other types
- Built-in RS485 or M-Bus ports for pulse output models compatible with Synergy and Xpress
- 70°C model ideal for electric vehicle charging stations
- Modular housing
- Sealable terminal blocks, standard supplied
- EN degree of protection: IP40 on front; IP20 at terminals.

Synergy supervision and energy management software
See Section 30.

Xpress configuration and remote control software
See Section 30.

EXM series expansion modules
See page 31-3.

Certifications and compliance

Certifications obtained: MID Class B (EN 50470-1, EN 50470-3), certifications per module B (type tests) + module D (production conformity).
Compliant with standards: EN 50470-1, EN 50470-3, TR50579.

- ① Multi-measurements:
 - Total and partial active energy
 - Total and partial reactive energy
 - Voltage
 - Current
 - Active and reactive power
 - Power factor
 - Frequency
 - Total and partial hour counter
 - Average active power (calculation made using the last 15 minutes of data)
 - Maximum demand.

Three-phase with or without neutral, non expandable



DMED300T2
DMED301
DMED302

new



DMED305T2
DMED330
DMED332

new

Three-phase with or without neutral, expandable



DMED310T2



EXM1010

Order code	Description	Qty per pkg	Wt
		n°	[kg]

Digital meter for three-phase with neutral. 80A direct connection.

DMED300T2	2 programmable static outputs, multi-measurements ^① , 4U	1	0.360
DMED300T2UL	2 programmable static outputs, multi-measurements ^① , cULus certified, 4U	1	0.360
DMED301	4U, RS485 interface, multi-measurements ^① , 4U	1	0.360
DMED301UL	RS485 interface, multi-measurements ^① , cULus certified, 4U	1	0.360
DMED302	4M-Bus interface, multi-measurements ^① , 4U	1	0.360

Digital meter for three-phase with or without neutral. Connection by CT /5A.

DMED305T2	2 programmable static outputs, multi-measurements ^① , 4U	1	0.332
DMED330	RS485 interface, multi-measurements ^① , 4U	1	0.332
DMED332	M-Bus interface, multi-measurements ^① , 4U	1	0.332

Order code	Description	Qty per pkg	Wt
		n°	[kg]

Digital meter for three-phase with or without neutral. Connection by CT /5A.

DMED310T2	4U, 2 programmable static outputs, multi-measurements ^① , expandable with EXM... modules series, 4U	1	0.332
------------------	--	---	-------

Order code	Description
------------	-------------

DMED310T2 EXPANSION MODULES.
Inputs and outputs.

EXM1000	2 digital inputs and 2 static outputs, opto-isolated
EXM1001	2 opto-isolated digital inputs and 2 relay outputs rated 5A 250VAC

Communication ports.

EXM1010	Opto-isolated USB interface
EXM1011	Opto-isolated RS232 interface
EXM1012	Opto-isolated RS485 interface
EXM1013	Opto-isolated Ethernet interface
EXM1020	Opto-isolated RS485 interface and 2 relay outputs rated 5A 250VAC
EXM1030	Data storage, clock-calendar (RTC) with backup reserve energy for data logging

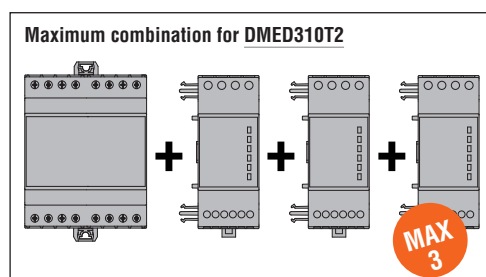

General characteristics

The energy meters are digital meters/analyzers of electric energy for systems with direct three-phase connection or by CT.

Operational characteristics

- LCD multifunction meter
- Nominal supply voltage: 380...415VAC (L-L); UL nominal supply voltage: 120VAC (L-N), 240VAC (L-L), 60Hz, direct two-phase + N
- Active energy measurement and accuracy: Class 0.5s (IEC/EN/BS 62053-22) for DMED305T2, DMED330 and DMED332; Class 1^② (IEC/EN/BS 62053-21) for DMED300T2, DMED301 and DMED302; Class 0.5 (ANSI C12.20) for DME3...UL
- Active energy measurement and accuracy: Class 2 (IEC/EN/BS 62053-23)
- Metrological LED with pulse emission for consumption indication
- Clearable partial active energy measurements
- 1 programmable digital input
- 2 programmable static outputs for DMED300T2, DMED305T2 and DMED310T2
- Built-in RS485 or M-Bus ports for pulse output models compatible with Synergy and Xpress
- Optical interface for EXM... expansion modules with DMED310T2
- Modular housing, 4 module
- Sealable terminal blocks, standard supplied
- EN degree of protection: IP40 on front; IP20 at terminals.

Synergy supervision and energy management software
See Section 30.

Xpress configuration and remote control software
See Section 30.

EXM series expansion modules
See page 31-3.

Certifications and compliance

Certifications obtained: EAC, RCM for all types, cULus for DMED...UL.

Compliant with standards: IEC/EN/BS 50470-1, IEC/EN/BS 61010-1, IEC 61010-2-030.

① Multi-measurements:

- Total and partial active energy
- Total and partial reactive energy
- Voltage
- Current
- Active and reactive power
- Power factor
- Frequency
- Total and partial hour counter
- Average active power (calculation made using the last 15 minutes of data)
- Maximum demand.

② Class 1 according to IEC/EN/BS 62053-21, accuracy measured in the 0.75A-80A range: 0.5%

Energy meters
MID certified

Three-phase with neutral, non expandable, MID certified

MID



DMED300T2MID
DMED301MID
DMED301MID7
DMED302MID

new



-25...+70°C



DMED305T2MID
DMED330MID
DMED332MID

Three-phase with neutral, expandable, MID certified

MID



DMED310T2MID



EXM1010

Order code	Description	Qty per pkg	Wt
		n°	[kg]

Digital meter for three-phase with neutral. 80A direct connection.

DMED300T2MID	2 programmable static outputs, multi-measurements❶, 4U	1	0.360
DMED301MID	RS485 interface, multi-measurements❶, 4U	1	0.360
DMED301MID7	RS485 interface, multi-measurements❶, -25...+70°C, 4U	1	0.360
DMED302MID	M-Bus interface, multi-measurements❶, 4U	1	0.360

Digital meter for three-phase with neutral. Connection by CT /5A.

DMED305T2MID	2 programmable static outputs, multi-measurements❶, 4U	1	0.332
DMED330MID	RS485 interface, multi-measurements❶, 4U	1	0.332
DMED332MID	M-Bus interface, multi-measurements❶, 4U	1	0.332

Order code	Description	Qty per pkg	Wt
		n°	[kg]

Digital meter for three-phase with neutral. Connection by CT /5A.

DMED310T2MID	2 programm. static outputs, multi-measurements❶, expandable, with EXM... modules series, 4U graphic LCD display	1	0.332
--------------	---	---	-------

Order code	Description
------------	-------------

DMED310T2 MID EXPANSION MODULES. Inputs and outputs.

EXM1000	2 digital inputs and 2 static outputs, opto-isolated
EXM1001	2 opto-isolated digital inputs and 2 relay outputs rated 5A 250VAC

Communication ports.

EXM1010	Opto-isolated USB interface
EXM1011	Opto-isolated RS232 interface
EXM1012	Opto-isolated RS485 interface
EXM1013	Opto-isolated Ethernet interface
EXM1020	Opto-isolated RS485 interface and 2 relay outputs rated 5A 250VAC

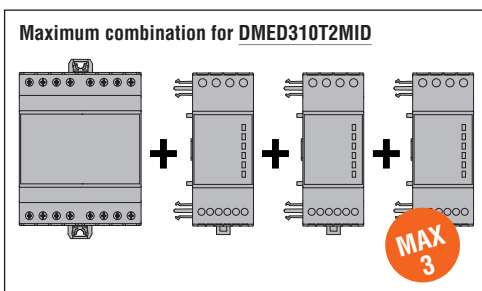

General characteristics

The DME... series energy meters, MID certified, are compulsory in Europe, are needed for billing purposes between electricity suppliers and consumers and for energy consumption measurement in directly or CT connected three-phase installations.

Operational characteristics

- LCD multifunction meter
- Nominal supply voltage: 230VAC (L-N); 400VAC (L-L)
- Voltage range: 187...264VAC (L-N); 323...456VAC (L-L)
- Active energy measurement and accuracy: Class B (EN 50470-3)
- Reactive energy measurement and accuracy: Class 2 (IEC/EN/BS 62053-23)
- Metrological LED with pulse emission for consumption indication
- Clearable partial energy measurements
- 1 programmable digital input
- Built-in RS485 or M-Bus ports for pulse output models compatible with Synergy and Xpress
- 70°C model ideal for electric vehicle charging stations
- Optical interface for EXM... expansion modules with DMED310T2MID
- Modular housing 4 module
- Sealable terminal blocks, standard supplied
- EN degree of protection: IP40 on front; IP20 at terminals.

Synergy supervision and energy management software See Section 30.

Xpress configuration and remote control software See Section 30.

EXM series expansion modules See page 31-3.

Certifications and compliance

Certifications obtained: MID Class B (EN 50470-1, EN 50470-3), certifications per module B (type tests) + per module D (production conformity). Compliant with standards: EN/BS 50470-1, EN/BS 50470-3, TR50579.

❶ Multi-measurements:

- Total and partial active energy
- Total and partial reactive energy
- Voltage
- Current
- Active and reactive power
- Power factor
- Frequency
- Total and partial hour counter
- Average active power (calculation made using the last 15 minutes of data)
- Maximum demand.

Three-phase with neutral,
MID certified

MID



DMED300F



EXM1010

Order code	Description	Qty per pkg	Wt
		n°	[kg]

Digital meter for three-phase with neutral, non expandable, complete with UTF certificates for installations in Italy.

DMED300F	DMED300T2MID, complete with UTF certificate	1	0.360
DMED301F	DMED301MID, complete with UTF certificate	1	0.381
DMED305F	DMED305T2MID, complete with UTF certificate	1	0.381
DMED330F	DMED330MID, complete with UTF certificate	1	0.381

Digital meter for three-phase with neutral, expandable, complete with UTF certificates for installations in Italy.

DMED310F	DMED310T2MID, complete with UTF certificate	1	0.381
-----------------	---	---	-------

Order code	Description
------------	-------------

DMED310F EXPANSION MODULES.
Inputs and outputs.

EXM1000	2 digital inputs and 2 static outputs, opto-isolated
EXM1001	2 opto-isolated digital inputs and 2 relay outputs rated 5A 250VAC
EXM1002	4 opto-isolated digital inputs and 2 relay outputs rated 5A 250VAC

Communication ports.

EXM1010	Opto-isolated USB interface
EXM1011	Opto-isolated RS232 interface
EXM1012	Opto-isolated RS485 interface
EXM1013	Ethernet interface with Web server function
EXM1020	Opto-isolated RS485 interface and 2 relay outputs rated 5A 250VAC

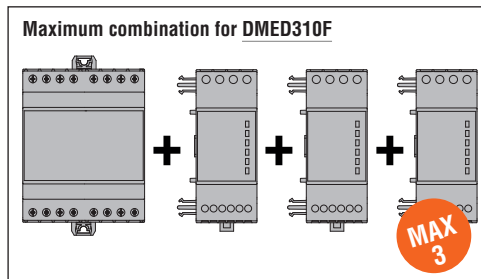

General characteristics

The UTF (Finance Technical Office) certification is required in Italy in case of applications where taxes have to be paid due to energy production (Italian regulations for plants >20kW). The certificates must be associated to the energy meter (MID version) and to each single current transformer is needed (see page 25-17 for selection).

DME... energy meters, MID version, for three-phase systems with or without current transformers can be supplied with the certificates included (DME...F). DMED310F... can be expanded up to 3 EXM... modules.

If required, the fifth certificate relevant to the meter and current transformer combination can be supplied as well (see page 25-17).

Operational characteristics

- LCD multifunction meter
- Nominal supply voltage: 230VAC (L-N); 400VAC (L-L)
- Voltage range: 187...264VAC (L-N); 323...456VAC (L-L)
- Active energy measurement and accuracy: Class B (EN 50470-3)
- Reactive energy measurement and accuracy: Class 2 (IEC/EN/BS 62053-23)
- Metrological LED with pulse emission for consumption indication
- Clearable partial energy measurements
- 1 programmable digital input
- Models with 2 programmable static outputs and built-in RS485 compatible with Synergy and Xpress
- Optical interface for EXM... expansion modules with DMED310F
- Modular housing 4 module
- Sealable terminal blocks, standard supplied
- EN degree of protection: IP40 on front; IP20 at terminals.

Multi-measurements

- Total and partial active energy
- Total and partial reactive energy
- Voltage
- Current
- Active and reactive power
- Power Factor
- Frequency
- Total and partial hour counter
- Average active power (calculation made using the last 15 minutes of data)
- Maximum demand.

Synergy supervision and energy management software
See Section 30.

Xpress configuration and remote control software
See Section 30.

EXM series expansion modules
See page 31-3.

Certifications and compliance

Certifications obtained: MID Class B (EN 50470-1, EN 50470-3), certifications per module B (type tests) + per module D (production conformity) for DMED300F and DMED310F energy meters.

UTF certificates are standard supplied.

Compliant with standards: EN 50470-1, EN 50470-3, TR 50579.

Current transformer kit with UTF certificates



DM...

new

new

Order code	Description of CTs included	Qty per pkg n°	Wt [kg]
Kit comprising of three /5A and class 0.5s current transformers			
DM1TP0060FKIT	3 DM1TP0060, complete with UTF certificate	1	1.440
DM1TP0080FKIT	3 DM1TP0080, complete with UTF certificate	1	1.440
DM1TP0100FKIT	3 DM1TP0100, complete with UTF certificate	1	1.560
DM1TP0150FKIT	3 DM1TP0150, complete with UTF certificate	1	1.680
DM1TP0200FKIT	3 DM1TP0200, complete with UTF certificate	1	1.620
DM1TP0250FKIT	3 DM1TP0250, complete with UTF certificate	1	1.620
DM1TP0300FKIT	3 DM1TP0300, complete with UTF certificate	1	1.680
DM1TP0400FKIT	3 DM1TP0400, complete with UTF certificate	1	1.680
DM1TP0600FKIT	3 DM1TP0600, complete with UTF certificate	1	1.680
DM3TP0500FKIT	3 DM3TP0500, complete with UTF certificate	1	2.160
DM3TP0600FKIT	3 DM3TP0600, complete with UTF certificate	1	2.160
DM3TP0800FKIT	3 DM3TP0800, complete with UTF certificate	1	2.280
DM4TP1200FKIT	3 DM4TP1200, complete with UTF certificate	1	2.280
DM5TP1000FKIT	3 DM5TP1000, complete with UTF certificate	1	2.820
DM5TP1250FKIT	3 DM5TP1250, complete with UTF certificate	1	2.760
DM5TP1600FKIT	3 DM5TP1600, complete with UTF certificate	1	2.880
DM5TP2000FKIT	3 DM5TP2000, complete with UTF certificate	1	2.940
DM5TP2500FKIT	3 DM5TP2500, complete with UTF certificate	1	3.120
DM5TP3000FKIT	3 DM5TP3000, complete with UTF certificate	1	2.940

General characteristics

The UTF (Finance Technical Office) certification is required in Italy in case of applications where taxes have to be paid due to energy production (Italian regulations for plants >20kW). The certificates must be associated to the energy meter (MID version, see page 25-12 for selection) and to each single current transformer is needed.

The DM...TP type accuracy current transformers (CTs) can be provided in a kit version made by three CTs and relative UTF certificates.

If required, the fifth certificate relevant to the meter and current transformer combination can be supplied as well.

The DM...TP type accuracy current transformers (CTs) are installed in an electrical system to reduce the line current to a secondary value of 5A compatible with the ammeter inputs of the digital multimeters or protection relays.

DM...TP are accuracy current transformers in class 0.5s without a primary winding and are normally used for high primary current values starting from 60A.

The number of loops of the primary cable does not modify the accuracy but converts the primary current value proportional to secondary current (see page 25-33).

Operational characteristics

- Operating frequency: 50...60Hz
- Secondary output current: 5A
- Overload withstand: 120% I_{pn}
- Rated insulation voltage U_i: 720V
- Rated short time thermal current I_{th}: 40-60I_{pn} for 1 second
- Rated dynamic current I_{dyn}: 2.5I_{th} for 1 second
- Insulation (dry type): class E
- Screw fixing terminals
- Sealable terminal covers
- Fixing on 35mm DIN rail (IEC/EN/BS 60715) or by screws (fixing elements standard supplied with the product)
- EN degree of protection: IP30.
- Ambient conditions
 - Operating temperature: -25...+50°C
 - Storage temperature: -40...+80°C.
 - Relative humidity, non condensing: 90%.

Compliance

Compliant with standards: IEC/EN/BS 61869-2, IEC/EN/BS 61869-1.

System certificate



Order code	Description
DMCERTUTF	UTF system certificate

Expandable



DMECD



EXM1010

Order code	Description	Qty per pkg	Wt
		n°	[kg]
Data concentrator for general use.			
DMECD	With 8 programmable digital inputs, expandable, for data collection + pulse count from DMED..., RS485 port	1	0.337

Order code	Description
------------	-------------

DME CD EXPANSION MODULES.
Inputs and outputs.

EXM1000	2 digital inputs and 2 static outputs, opto-isolated
EXM1001	2 opto-isolated digital inputs and 2 relay outputs rated 5A 250VAC
EXM1002	4 opto-isolated digital inputs and 2 relay outputs rated 5A 250VAC

Communication ports.

EXM1010	Opto-isolated USB interface
EXM1011	Opto-isolated RS232 interface
EXM1012	Opto-isolated RS485 interface
EXM1013	Opto-isolated Ethernet interface
EXM1020	Opto-isolated RS485 interface and 2 relay outputs, rated 5A 250VAC
EXM1030	Data storage, clock-calendar (RTC) with backup reserve energy for data logging

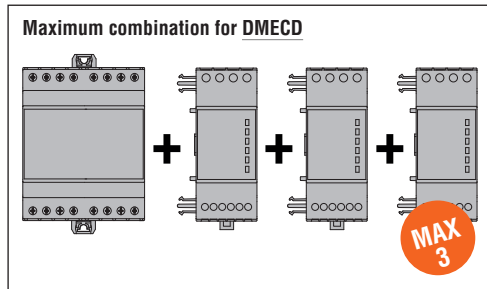

General characteristics

DMECD is equipped with 8 inputs, which can be increased up to a maximum of 14 with expansion modules EXM1000/1001/1002, that allow to indirectly interface devices without communication as long as they have at least one pulse output.

It is capable of pulse counting that comes in from the outputs of meters for energy, water, gas and other types of consumption: All data is viewed on its display or can also be available for PCs through its built-in RS485 interface using Synergy or Xpress software.

It can be expanded with up to 3 EXM... series modules by optical interface.

With the programmable functions, average values can be determined for instantaneous quantities, such as power, speed, production rate, gas and water consumption, etc.

Operational characteristics

- Backlight graphic LCD meter, multifunction
- Nominal supply voltage: 100...240VAC/110...250VDC
- Voltage range: 85...264VAC/93.5...300VDC
- 8 inputs, expandable with EXM... modules up to 14
- Built-in RS485 communication port
- Modbus-RTU, ASCII and TCP communication protocol
- Clearable total and partial counters for each channel
- Programmable general counters
- Calculation of derivative average values
- Mathematical operations among counters
- Modular housing, 4 module
- EN degree of protection: IP40 on front; IP20 at terminals.

Synergy supervision and energy management software
See Section 30.

Xpress configuration and remote control software
See Section 30.

EXM series expansion modules
See page 31-3.

Certifications and compliance

Certifications obtained: cULus, EAC.
Compliant with standards: IEC/EN/BS 61010-1, IEC/EN/BS 61000-6-2, IEC/EN/BS 61000-6-3.

Power analyzers with widescreen colour LCD



DMG...



new

Order code	Description	Qty per pkg	Wt
		n°	[kg]
Auxiliary supply 100...240VAC.			
DMG7000	Expandable with 3 EXP... modules	1	0.375
DMG7500	Expandable with 3 EXP... modules, built-in RS485 port, compatible with EASY BRANCH power monitoring system	1	0.375
DMG8000	Expandable with 3 EXP... modules, built-in Ethernet port, data memory for logging, compatible with EASY BRANCH power monitoring system	1	0.375
DMG9000	Expandable with 3 EXP... modules, built-in RS485 and Ethernet port, data memory for logging, compatible with EASY BRANCH power monitoring system	1	0.375

Expansion modules



EXP10...



Order code	Description	Qty per pkg	Wt
		n°	[kg]
Inputs and outputs.			
EXP1000	4 opto-isolated digital inputs	1	0.060
EXP1001	4 opto-isolated static outputs	1	0.054
EXP1002	2 digital inputs and 2 static outputs, opto-isolated	1	0.058
EXP1003	2 relay outputs rated 5A 250VAC	1	0.050
EXP1004	2 analog inputs, opto-isolated 0/4...20mA or PT100 or 0...±10V or 0...±5V	1	0.056
EXP1005	2 analog outputs, opto-isolated 0/4...20mA, 0-10V or 0...±5V	1	0.064
EXP1008	2 opto-isolated digital inputs and 2 relay outputs rated 5A 250VAC	1	0.058
Communication ports.			
EXP1010	Opto-isolated USB interface	1	0.060
EXP1011	Opto-isolated RS232 interface	1	0.040
EXP1012	Opto-isolated RS485 interface	1	0.050
EXP1013	Opto-isolated Ethernet interface	1	0.060
EXP1014	Opto-isolated Profibus-DP interface	1	0.080

Communication devices



CX01



CX02

Order code	Description	Qty per pkg	Wt
		n°	[kg]
CX01	USB/optical device with PC ↔ LOVATO Electric product connecting cable, for programming, data download, diagnostics and firmware upgrade	1	0.090
CX02	Wi-Fi device for PC ↔ LOVATO Electric product programming, data download, diagnostics and cloning	1	0.090

General characteristics

DMG... power analysers display electrical values on their large colour LCD display with exceptional accuracy to enable precise monitoring of power grids. They are designed in flush-mount housing (cutout 92x92mm/3.62x3.62") with 3 slots for EXP series plug-in expansion modules to adapt them to a variety of applications.

The use of NFC technology allows the user to configure the unit and make settings with a smart device. The optical port on the back of the unit enables the user to make settings, run power grid diagnostics and update the unit's firmware. The graphic interface, available in 10 languages (English, French, German, Italian, Spanish, Portuguese, Polish, Russian, Czech and Chinese), has been designed to facilitate the display of data, including:

- Voltage (phase, phase-to-phase and system)
- Phase current (calculated neutral current, and measured neutral current on the DMG9000)
- Measurements on 4 quadrants
- Power (active, reactive and apparent phase and total power)
- Power factor (phase and total)
- Frequency
- Maximum (HIGH), minimum (LOW) and average (AVERAGE) of all measured values
- Peak power/current (max demand)
- Voltage and current asymmetry and active power unbalance
- Total harmonic distortion (voltage and current)
- Voltage and current harmonic analysis up to the 63rd order
- Active, reactive and apparent energy metering (partial and total)
- Hour meter (total and partial, programmable).

The EASY BRANCH multi-circuit measurement system

The DMG7500, DMG8000 and DMG9000 can also be used in multi-circuit applications when more than one load is to be monitored in the electrical switch board. All values are shown on the display or via the integrated communications interface.

Refer to page 25-20 for the components of the EASY BRANCH measurement system.

Operational characteristics

- Auxiliary power: 100...240VAC/110...250VDC
- Voltage measurement range: 50...720VAC L-L
- can be used in medium and high voltage systems using TV
- Nominal input current: 5A or 1A with an external current transformer
- Frequency measurement range: 45...66Hz, 360...440Hz
- Accuracy (IEC/BS 61557-12):
 - voltage: Class 0.5 (Vref = 400VAC L-L)
 - current: Class 0.2 (Iref = 5AAC)
 - power: Class 0.5 (active), Class 1 (reactive)
 - power factor: Class 0.5
 - frequency: Class 0.02
 - THD and harmonics V and I: Class 5
 - active energy: Class 0.5s
 - active energy: Class 0.5s (IEC/EN/BS 62053-22)
 - reactive energy: Class 1 (IEC/EN/BS 62053-24)
- Integrated data memory (DMG8000, DMG9000)
- Integrated communications ports (RS485 or Ethernet)
- Communications protocols: Modbus-RTU, ASCII and TCP
- Compatible with Synergy, Xpress and App NFC
- Protection rating: IP65 for front panel.

Synergy supervision and energy management software
See Section 30.

Xpress configuration and remote control software
See Section 30.

Lovato App NFC
See Section 30.

EXP series expansion modules
See page 31-2.

Certifications and compliance
Compliant with standards: IEC/EN/BS 61010-1, IEC/EN/BS 61000-6-2 and IEC/EN/BS 61000-6-4.

For versions with 12...48VDC power, contact our Technical Service office; see contact details on inside front cover.

EASY BRANCH power monitoring system



EXS0000



EXS4000



EXS4001



EXS1063

EXS3063

new

Order code	Description	Qty per pkg	Wt
		n°	[kg]

Modules for EASY BRANCH system.			
EXS0000	Bus module for EASY BRANCH power monitoring system	1	0.090
EXS4000	Current measuring module with 4 inputs for electronic RJ45 CTs	1	0.140
EXS4001	Current measuring module with 2 inputs for three-phase traditional CTs or 6 inputs for single-phase traditional CTs	1	0.210

Electronic current transformers for EASY BRANCH system. Single-phase.			
EXS1032	32A single-phase electronic current transformer with RJ45 cable, 2m long	1	0.060
EXS1063	63A single-phase electronic current transformer with RJ45 cable, 2m long	1	0.060
EXS1080	80A single-phase electronic current transformer with RJ45 cable, 2m long	1	0.105
EXS1125	125A single-phase electronic current transformer with RJ45 cable, 2m long	1	0.105

Three-phase. ①			
EXS3032	32A three-phase electronic current transformer ① with RJ45 cable, 2m long	1	0.080
EXS3063	63A three-phase electronic current transformer ① with RJ45 cable, 2m long	1	0.080
EXS3080	80A three-phase electronic current transformer ① with RJ45 cable, 2m long	1	0.135
EXS3125	125A three-phase electronic current transformer ① with RJ45 cable, 2m long	1	0.135

Traditional current transformers.
See page 25-31 to 25-35.

① Configurable as single-phase current transformer (3 single-phase measure per each EXS3...).

General characteristics

The EASY BRANCH multi-circuit metering system is a modern solution to the need for electrical parameter metering when more than one load is to be monitored inside a single electrical enclosure. Each DIN rail mounting current metering unit can monitor 2 or 4 measurement points and display the values on the DMG7500, DMG8000 or DMG9000 power analysers to which it is connected, thus centralising the display of data, which includes:

- Phase current
- Measurements on 4 quadrants
- Power (active, reactive and apparent phase and total power)
- Power factor (phase and total)
- Maximum (HIGH), minimum (LOW) and average (AVERAGE) of all measured values
- Peak power/current (max demand)
- Current asymmetry and active power unbalance
- Total harmonic distortion (current)
- Current harmonic analysis up to the 63rd order
- Active, reactive and apparent energy metering (partial and total).

The RJ45 port on the EXS4000 metering module provides foolproof connection of EXS1... and EXS3... electronic current transformers.

The values can also be monitored using the communications ports of DMG... power analysers, to which up to 8 current metering modules can be connected in cascade thanks to the integrated communications bus with standard Ethernet cable (cat. 6), which also provides power.

Connecting 5 or more EXS4... current metering modules requires a 24VDC-0.2A power supply. Each measurement point can be configured as single- or three-phase, up to a total of 33 three-phase or 99 single-phase points.

Operational characteristics of EXS4... current measuring modules

- Power supplied by the bus cable (connecting 5 or more EXS4... current metering modules requires a 24VDC-0.2A power supply)
- nominal input current:
EXS4000: 32A, 63A, 80A or 125A, depending on the connected EXS1... or EXS3... electronic transformer.
EXS4001: 5A or 1A via external current transformer
- Accuracy (IEC/BS 61557-12):
 - current: Class 0.5 (Iref = 5AAC)
 - power: Class 1 (active), Class 2 (reactive)
 - power factor: Class 1
 - THD and current harmonics: Class 5
 - active energy: Class 1
 - active energy: Class 1 (IEC/EN/BS 62053-21)
 - reactive energy: Class 2 (IEC/EN/BS 62053-23)
- Diagnostics LED indicates correct power supply and electronic current transformer recognition
- Mounts to 35mm omega rail (IEC/EN/BS 60715).

Operational characteristics of EXS1... - EXS3... electronic current transformers

- Diagnostics LED to confirm connection
- Pre-wired cable: 2m
- RJ45 connector.

Synergy supervision and energy management software
See Section 30.

Xpress configuration and remote control software
See Section 30.

Lovato App NFC
See Section 30.

Certifications and compliance

Compliant with standards: IEC/EN/BS 61010-1, IEC/EN/BS 61000-6-2 and IEC/EN/BS 61000-6-4.

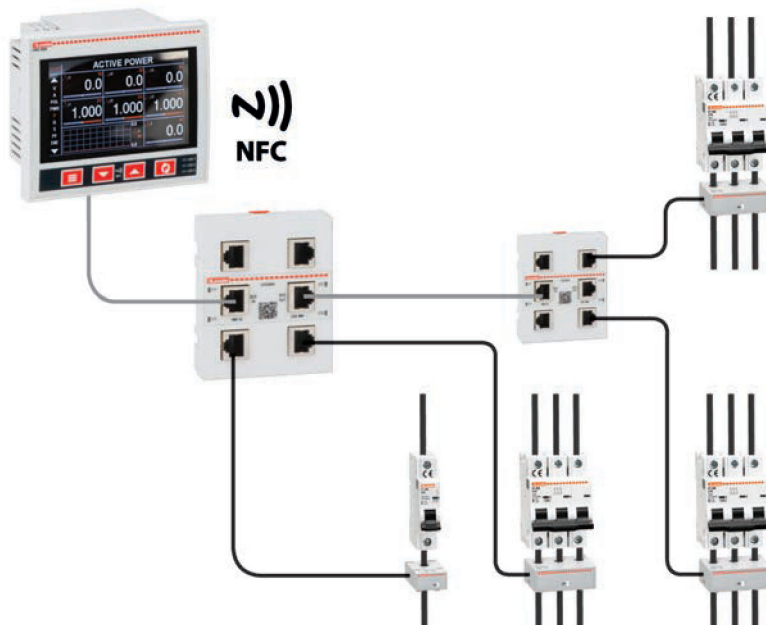

Modular LCD multimeters, non expandable



DMG1...



DMG200 - DMG210

Kits with CT

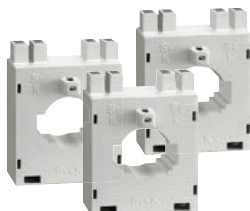

DMGKIT100150

Order code	Description	Qty per pkg.	Wt
		n°	[kg]
DMG100	Icon LCD, auxiliary supply 100...240VAC/120...250VDC. Multilanguage: Italian, English, French, Spanish, Portuguese and German	1	0.294
DMG110	Icon LCD, built-in RS485 port, auxiliary supply 100...240VAC/120...250VDC. Multilanguage: Italian, English, French, Spanish, Portuguese and German	1	0.294
DMG200	Graphic 128x80 pixel LCD, auxiliary supply 100-240VAC/110-250VDC. Multilanguage: Italian, English, French, Spanish and Portuguese	1	0.294
DMG200L01	Graphic 128x80 pixel LCD, auxiliary supply 100-240VAC/110-250VDC. Multilanguage: English, Czech, Polish, German and Russian	1	0.294
DMG210	Graphic 128x80 pixel LCD, built-in RS485 port, auxiliary supply 100-240VAC/110-250VDC. Multilanguage: Italian, English, French, Spanish and Portuguese	1	0.300
DMG210L01	Graphic 128x80 pixel LCD, built-in RS485 port, auxiliary supply 100-240VAC/110-250VDC. Multilanguage: English, Czech, Polish, German and Russian	1	0.300

Order code	Description	Qty per pkg.	Wt
		n°	[kg]
DMGKIT100060	Composed of one DMG100 multimeter and n°3 CTs 60/5A for Ø22mm cable	1	1.035
DMGKIT100100	Composed of one DMG100 multimeter and n°3 CTs 100/5A for Ø22mm cable	1	1.035
DMGKIT100150	Composed of one DMG100 multimeter and n°3 CTs 150/5A for Ø23mm cable	1	0.856
DMGKIT100250	Composed of one DMG100 multimeter and n°3 CTs 200/5A for Ø23mm cable	1	0.856

General characteristics

DMG... digital multimeters are available with a modular housing, 4 module size, and are equipped with a graphic backlight LCD (except DMG100/110 with icon display) capable of providing extremely clear, intuitive and flexible viewing of all electrical parameters of an installation.

For DMG110 and DMG210 versions, there is a built-in isolated RS485 interface.

Main measurements:

- Voltage: phase, line and system values
- Current: phase values (neutral current calculated)
- Power: apparent, active and reactive phase and total values
- P.F.: Power Factor per phase and total
- Frequency of measured voltage value
- HIGH-LOW-AVERAGE value functions of all measurements
- Maximum demand of power and current values
- Asymmetric voltage and current
- Total harmonic distortion (THD) of voltage and current values
- Energy meters for active, reactive and apparent values
- Hour counter (total and partial, 1 on DMG200/210, 4 programmable on DMG100/110)
- Phase energy (DMG100/110)
- Harmonic analysis up to the 15th order (DMG100/110).

Operational characteristic

- Auxiliary supply voltage range: 100...240VAC / 110...250VDC
- Maximum rated measurement voltage
 - 600VAC (DMG100/110)
 - 690VAC (DMG200/210)
- Voltage measurement range:
 - 50...720VAC phase-to-phase (DMG100/110)
 - 20...830VAC phase-to-phase (DMG200/210)
- Usage in medium and high-voltage systems with voltage transformers
- Rated input current: With external CT /5A (also 1A for DMG100/110)
- Current measurement range with CT up to 10,000A
- Frequency measurement range: 45...66Hz, 360...440Hz
- True RMS measurements for voltage and current values
- Accuracy:
 - Voltage: ±0.5% (50...720VAC for DMG1... (50...830VAC) for DMG2...
 - Current: ±0.5% (0.1...1.1In)
 - Power: ±1% f.s.
 - Frequency: ±0.05%
 - Active energy: Class 1 (IEC/EN/BS 62053-21)
 - Reactive energy: Class 2 (IEC/EN/BS 62053-23)
- Non-volatile memory for data storage
- Communication protocol Modbus-RTU and ASCII (only for DMG110 and DMG210)
- Programming and remote control by software (only for DMG110 and DMG210; compatible with **Synergy** and **Xpress** software)
- Modular housing, 4 module
- EN degree of protection: IP40 on front; IP20 at terminals.

CURRENT TRANSFORMERS OF DMG... KITS

- Operating frequency: 50...60Hz
- Secondary output current: 5A
- Overload withstand: 120% I_{pn}
- Rated insulation voltage U_i: 720V
- Rated short time thermal current I_{th}: 40...60I_{pn} for 1 second
- Rated dynamic current I_{dyn}: 2.5I_{th} for 1 second
- Insulation (dry type): class E
- Faston terminals
- EN degree of protection: IP30.

Synergy supervision and energy management software
See Section 30.

Xpress configuration and remote control software
See Section 30.

Certifications and compliance

Certifications obtained: cULus, EAC and RCM.
Compliant with standards: DMG100/110: IEC/EN/BS 61010-1, IEC/EN/BS 61010-2-030, IEC/EN/BS 61000-6-2, IEC/EN/BS 61000-6-3, UL 61010-1, CSA C22.2 n° 61010-1, UL 61010-2-030, CSA 22.2 n° 61010-2-030.
DMG200/210: IEC/EN/BS 61010-1, IEC/EN/BS 61000-6-2, IEC/EN/BS 61000-6-4, UL 61010-1, UL508, CSA C22.2 n°14.

Modular LCD multimeters, expandable



DMG300

Order code	Description	Qty per pkg	Wt
		n°	[kg]
DMG300	Graphic 128x80 pixel LCD, harmonic analysis, auxiliary supply 100...240VAC/110...250VDC, expandable with modules series EXM... Multilanguage: Italian, English, French, Spanish and Portuguese	1	0.320
DMG300L01	Graphic 128x80 pixel LCD, harmonic analysis, auxiliary supply 100...240VAC/110...250VDC, expandable with modules series EXM... Multilanguage: English, Czech, Polish, German and Russian	1	0.320

Expansion modules



EXM1010

Order code	Description
DMG300 AND DMG300L01 EXPANSION MODULES. Inputs and outputs.	
EXM1000	2 digital inputs and 2 static outputs, opto-isolated
EXM1001	2 opto-isolated digital inputs and 2 relay outputs rated 5A 250VAC
EXM1002	4 opto-isolated digital inputs and 2 relay outputs rated 5A 250VAC
Communication ports.	
EXM1010	Opto-isolated USB interface
EXM1011	Opto-isolated RS232 interface
EXM1012	Opto-isolated RS485 interface
EXM1013	Opto-isolated Ethernet interface
EXM1020	Opto-isolated RS485 interface and 2 relay outputs rated 5A 250VAC
EXM1030	Data storage, clock-calendar (RTC) with backup battery for data logging

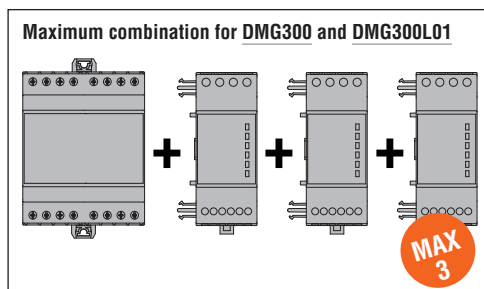

General characteristics

DMG300... digital multimeters are available with a modular housing, 4 module size, and are equipped with a graphic backlight LCD capable of providing extremely clear, intuitive and flexible viewing of all electrical parameters of a system. The very accurate measurements combined with their extreme compactness provide an ideal solution for every type of application. Expandable with up to 3 module EXM... series by optical interface.

Main measurements:

- Voltage: phase, line and system values
- Current: phase values (neutral current calculated)
- Power: apparent, active and reactive phase and total values
- P.F.: Power Factor per phase and total
- Frequency of measured voltage value
- HIGH-LOW-AVERAGE value functions for all measurements
- Maximum demand of power and current values
- Voltage and current asymmetry
- Total harmonic distortion (THD) of voltage and current values
- Harmonic analysis of voltage and current up to 31^o order
- Energy meters for active, reactive, apparent partial and total values, programmable tariff functions
- Hour counter for programmable total and partial hours
- Pulse counter for general use: consumption pulse counting for water, gas, etc. with expansion module only.

Operational characteristics

- Auxiliary supply voltage range: 85...264VAC / 93.5...300VDC
- Voltage measurement range: 20...830VAC phase-to-phase
10...480VAC phase-neutral
- Usage in medium and high-voltage systems with voltage transformers
- Rated input current: With external CT, 5A or 1A
- Current measurement range with CT up to 10,000A
- Frequency measurement range: 45...66Hz, 360...440Hz
- True RMS measurements for voltage and current values
- Measurements accuracy:
 - Voltage: ±0.2% (50...830VAC)
 - Current: ±0.2% (0.1...1.1In)
 - Power: ±0.5% f.s.
 - Power factor: ±0.5%
 - Frequency: ±0.05%
 - Active energy: Class 0.5s (IEC/EN/BS 62053-22)
 - Reactive energy: Class 2 (IEC/EN/BS 62053-23)
- Non-volatile memory for data storage
- Communication protocol Modbus-RTU, ASCII and TCP (only with communication expansion modules)
- Programming and remote control by software (only with communication expansion modules); compatible with **Synergy** and **Xpress** software
- Modular housing, 4 module
- EN degree of protection: IP40 on front; IP20 at terminals.

Synergy supervision and energy management software
See Section 30.

Xpress configuration and remote control software
See Section 30.

EXM series expansion modules
See page 31-3.

Certifications and compliance

Certifications obtained: UL Listed, for USA and Canada (cULus - File E93601), as Auxiliary Devices - Multimeters; EAC and RCM for all.

Compliant with standards: IEC/EN/BS 61010-1, IEC/EN/BS 61000-6-2, IEC/EN/BS 61000-6-4, UL508, CSA C22.2 n° 14.

Flush-mount LCD multimeters, expandable



DMG600 - DMG610
DMG615 - DMG620



DMG611R...

new

Order code	Description	Qty per pkg	Wt [kg]
	Icon LCD 72x46mm/2.83x1.81", backlight, harmonic analysis, auxiliary supply 100...440/110...250VDC, expandable with modules series EXP...	n°	[kg]
DMG600	Front optical port, multilanguage ^①	1	0.300
DMG610	Front optical port, built-in RS485 serial port, multilanguage ^①	1	0.350
DMG611R0100	Front optical port, built-in RS485 serial port, multilanguage ^① . Current reading through 3 Rogowski coils included, max current 100A	1	0.350
DMG611R0500	Front optical port, built-in RS485 serial port, multilanguage ^① . Current reading through 3 Rogowski coils included, max current 500A	1	0.350
DMG611R3000	Front optical port, built-in RS485 serial port, multilanguage ^① . Current reading through 3 Rogowski coils included, max current 3000A	1	0.350
DMG611R6300	Front optical port, built-in RS485 serial port, multilanguage ^① . Current reading through 3 Rogowski coils included, max current 6300A	1	0.350
DMG615	Front optical port, built-in RS485 serial port, multilanguage ^① , class 0.5s	1	0.350
DMG620	Front optical port, built-in Ethernet port, multilanguage ^① , class 0.5s	1	0.350

^① Italian, English, French, Spanish and Portuguese.

General characteristics

DMG6... digital multimeters are capable of viewing the measurements with high accuracy on the wide icon LCD, which allow to control energy distribution networks. They are available with a flush-mount housing, (96x96mm/3.78"x3.78") and 1 expansion slot to fit plug-in expansion modules, suitable for numerous applications. The main features include an extended power supply voltage range, high measurement accuracy, expandability and icon interactive interface for simple use. They are equipped with a front optical port for programming via USB (CX01) or Wi-Fi (CX02) communication devices to allow:

- Configuration of parameters
- Parameters copy
- Cloning of stored data.

Main measurements:

- Voltage: phase, line and system values
- Current: phase values (neutral current calculated)
- Power: apparent, active and reactive phase and total values
- P.F.: Power Factor per phase and total
- Frequency of measured voltage value
- HIGH-LOW-AVERAGE value functions for all measurements
- Maximum demand of power and current values
- Voltage and current asymmetry
- Total harmonic distortion (THD): voltage and current
- Harmonic analysis of voltage and current up to the 15th order
- Energy meters for active, reactive, apparent partial and total values
- Hour counter for programmable total and partial hours.

Operational characteristics

- Auxiliary supply voltage range:
 - 100...440VAC / 110...250VDC[Ⓜ]
- Voltage measurement range: 50...720VAC L-L
- Usage in medium and high voltage systems with voltage transformers
- Rated input current: By external CT 5A or 1A
- Current reading through Rogowski coils for DMG611...
- Frequency measurement range 45...66Hz, 360...440Hz
- True RMS measurements: for voltage and current
- Measurement accuracy:
 - Voltage: ±0.5% (50...720VAC)
 - Current: ±0.5% (0.1...1.1In)
 - Power: ±1% f.s.
 - Frequency: ±0.05%
 - Active energy: Class 1 (IEC/EN/BS 62053-21)
 - Reactive energy: Class 2 (IEC/EN/BS 62053-23)
- Measurement accuracy DMG615/620::
 - Voltage: ±0.2% (50...720VAC)
 - Current: ±0.2% (0.1...1.1In)
 - Power: ±0.5% f.s.
 - Frequency: ±0.05%
 - Active energy: Class 0.5 (IEC/EN/BS 62053-22)
 - Reactive energy: Class 2 (IEC/EN/BS 62053-23)
- Non-volatile memory for data storage
- Communication protocol Modbus-RTU, ASCII and TCP
- Compatible **Synergy** and **Xpress** software
- Flush-mount housing 96x96mm/3.78"x3.78"
- EN degree of protection: IP54 on front.

Synergy supervision and energy management software
See Section 30.

Xpress configuration and remote control software
See Section 30.

EXP series expansion modules
See page 31-2.

Certifications and compliance

Certifications obtained: cULus (except DMG611... and DMG620), EAC, RCM; UL listed for USA and Canada (cULus - File E93601), as Auxiliary Devices - Multimeters. Compliant with standards: IEC/EN/BS 61010-1, IEC/EN/BS 61010-2-030, IEC/EN/BS 61000-6-2, IEC/EN/BS 61000-6-3, UL 61010-1, CSA C22.2 n° 61010-1, UL 61010-2-030, CSA 22.2 n° 61010-2-030.

[Ⓜ] Consult Technical support about versions with supply 12...48VDC

Expansion modules



EXP10...



MAX 1

Order code	Description	Qty per pkg	Wt [kg]
	EXPANSION MODULES Inputs and outputs.		
EXP1000	4 opto-isolated digital inputs		
EXP1001	4 opto-isolated static outputs		
EXP1002	2 digital inputs and 2 static outputs, opto-isolated		
EXP1003	2 relay outputs rated 5A 250VAC		
EXP1008	2 opto-isolated digital inputs and 2 relay outputs rated 5A 250VAC		
	Communication ports.		
EXP1010	Opto-isolated USB interface		
EXP1011	Opto-isolated RS232 interface		
EXP1012	Opto-isolated RS485 interface		
EXP1013	Opto-isolated Ethernet interface		

Communication devices



CX01



CX02

Order code	Description	Qty per pkg	Wt [kg]
		n°	[kg]
CX01	USB/optical device with PC ↔ LOVATO Electric product connecting cable, for programming, data download, diagnostics and firmware upgrade	1	0.090
CX02	Wi-Fi device for PC ↔ LOVATO Electric product programming, data download, diagnostics and cloning	1	0.090



Modular LED instruments single-phase, non expandable



DMK80R1



DMK81R1

Order code	Displayed measurements	Relay output	Qty per pkg	Wt
	n°	n°	n°	[kg]
Voltmeter.				
DMK80R1 	1 voltage value 1 max voltage value 1 min voltage value	1	1	0.268
Ammeter.				
DMK81R1 	1 current value 1 max current value 1 min current value	1	1	0.268

 Relay output with control and protection functions.

General characteristics

The DMK8... instruments are available with modular housing, 3 module size.

Measurements are True RMS values and provide for reliable operation even in the presence of harmonics.

Operational characteristics

- Auxiliary supply voltage: 220...240VAC
- Operating frequency: 50...60Hz
- True RMS measurements
- Max and min measurement storage
- 1 relay output with 1 changeover contact (SPDT)
- Modular DIN 43880 housing, 3 modules
- Terminals: 4mm²
- EN degree of protection: IP40 on front; IP20 on terminals.

DMK80R1

- Voltage measurement range: 15...660VAC
- Operating frequency range: 45...65Hz
- Programmable VT ratio: 1.00...500.00
- Accuracy: $\pm 0.25\%$ f.s. ± 1 digit

DMK81R1

- Current measurement range: 0.05...5.75A
- Operating frequency range: 45...65Hz
- Programmable CT ratio: 5...10,000
- Accuracy: $\pm 0.5\%$ f.s. ± 1 digit

Control and protection functions

DMK80R1

- Voltage loss or failure: OFF/5...85%
- Maximum voltage: OFF/102...120%
- Minimum voltage: OFF/70...98%
- Time delay for max-min voltage or voltage loss : 0.0...900.0 seconds.

DMK81R1

- Current loss: OFF/2...100%
- Maximum current: OFF/102...200%
- Maximum current instantaneous tripping: OFF/110...600%
- Minimum current: OFF/5...98%
- Time delay for max-min current or current loss : 0.0...900.0 seconds.

Certifications and compliance

Certifications obtained: EAC.

Compliant with standards: IEC/EN/BS 61010-1, IEC/EN/BS 61000-6-2, IEC/EN/BS 61000-6-3.

 Independent adjustable delays.

Modular LED instruments three-phase, non expandable



DMK70R1



DMK71R1



DMK75R1

Order code	Displayed measurements	Relay output	Qty per pkg	Wt [kg]
	n°	n°	n°	[kg]
Voltmeter.				
DMK70R1 Ⓢ	3 phase voltage values 3 phase to phase voltage values 3 max phase voltage values 3 max phase to phase voltage values 3 min phase voltage values 3 min phase to phase voltage values	1	1	0.264
Ammeter.				
DMK71R1 Ⓢ	3 phase current values 3 max phase current values 3 min phase current values	1	1	0.272
Combined voltmeter, ammeter and wattmeter.				
DMK75R1 ⓈⓈ	3 phase voltage values 3 phase to phase voltage values 3 phase current values 4 active power values, phase and total 3 maximum phase voltage values 3 maximum phase to phase voltage values 3 maximum phase current values 4 max active power, phase and total 3 minimum phase voltage values 3 minimum phase to phase voltage values 3 minimum phase current values 4 min active power, phase and total	1	1	0.280

- ① Connection also to single-phase.
- Ⓢ Relay output with control and protection functions.

General characteristics

The DMK7... instruments are available with modular housing, 3 module size. Measurements are True RMS values and provide for reliable operation even in the presence of harmonics.

Operational characteristics

- Auxiliary supply voltage: 220...240VAC
- Operating frequency: 50...60Hz
- True RMS measurements
- Max and min measurement storage
- 1 relay output with 1 changeover contact (SPDT)
- Modular DIN 43880 housing, 3 module
- Terminals: 4mm²
- EN degree of protection: IP40 on front; IP20 on terminals.

DMK70R1

- Voltage measurement range: 15...660VAC
- Operating frequency range: 45...65Hz
- Programmable VT ratio: 1.00...500.00
- Accuracy: ±0.25% f.s. ±1 digit

DMK71R1

- Current measurement range: 0.05...5.75A
- Operating frequency range: 45...65Hz
- Programmable CT ratio: 5...10,000
- Accuracy: ±0.5% f.s. ±1 digit

DMK75R1

- Voltage measurement range: 35...660VAC
- Current measurement range: 0.05...5.75A
- Frequency measure range: 45...65Hz
- Programmable VT ratio: 1.00...500.00
- Programmable CT ratio: 5...10,000
- Accuracy: Voltage ±0.25% f.s. ±1 digit
- Accuracy: Current ±0.5% f.s. ±1 digit

Control and protection functions

DMK70R1

- Phase loss or failure: OFF/5...85%
- Maximum voltage: OFF/102...120%
- Minimum voltage: OFF/70...98%
- Asymmetry: OFF/2...20%
- Phase sequence: OFF/L1-L2-L3/L3-L2-L1
- Maximum frequency: OFF/101...110%
- Minimum frequency: OFF/90...99%
- Time delay for max-min voltage, phase loss, asymmetry and min-max frequency Ⓢ: 0.0...900.0 seconds.

DMK71R1

- Current loss: OFF/2...100%
- Maximum current: OFF/102...200%
- Maximum current instantaneous tripping: OFF/110...600%
- Minimum current: OFF/5...98%
- Asymmetry: OFF/2...20%
- Time delay for max-min current or current loss and asymmetry Ⓢ: 0.0...900.0 seconds.

DMK75R1

Voltage

- Phase loss or failure: OFF/5...85%
- Maximum voltage: OFF/102...120%
- Minimum voltage: OFF/70...98%
- Asymmetry: OFF/2...20%
- Phase sequence: OFF/L1-L2-L3/L3-L2-L1

Current

- Current loss: OFF/2...100%
- Maximum current: OFF/102...200%
- Maximum current instantaneous tripping: OFF/110...600%
- Minimum current: OFF/5...98%
- Asymmetry: OFF/2...20%

Power

- Rated power: 1...10,000
- Maximum power: OFF/101...200%
- Maximum power instantaneous tripping: OFF/110...600%
- Minimum power: OFF/10...99%

Frequency

- Maximum frequency: OFF/101...110%
- Minimum frequency: OFF/90...99%
- Time delay for max-min voltage, max-min current or current loss, phase loss, asymmetry and min-max power Ⓢ: 0.0...900.0 seconds.

Certifications and compliance

Certifications obtained: EAC.
Compliant with standards: IEC/EN/BS 61010-1, IEC/EN/BS 61000-6-2, IEC/EN/BS 61000-6-3.

- Ⓢ Independent adjustable delays.

Flush-mount LED instruments single-phase, non expandable



DMK0...

Order code	Displayed measurements	Relay output	Qty per pkg	Wt [kg]
	n°	n°	n°	[kg]
Voltmeter.				
DMK00R1 Ⓜ	1 voltage value 1 max voltage value 1 min voltage value	1	1	0.323
Ammeter.				
DMK01R1 Ⓜ	1 current value 1 max current value 1 min current value	1	1	0.323
Voltmeter or ammeter.				
DMK02 Ⓜ	1 voltage or current value 1 maximum voltage or current value 1 minimum voltage or current value	–	1	0.290

Ⓜ The DMK02 can operate as a voltmeter or ammeter. It is duly equipped with two front plates (V and A) which must be fitted by the user depending on which instrument is required and on the wiring scheme used.

Ⓜ Relay output for control and protection functions.

General characteristics

The DMK0... instruments are available with flush-mount housing, 96x48mm/3.78x1.89". Measurements are True RMS values and provide for reliable operation even in the presence of harmonics.

Operational characteristics

- Auxiliary supply voltage: 220...240VAC;
- Operating frequency: 50...60Hz
- True RMS measurements
- Max. and min. measurement storage
- 1 relay output with 1 changeover contact (for DMK...R1 only)
- Housing: flush-mount 96x48mm/3.78x1.89"
- Terminals: 4mm²
- Degree of protection: IP54 on front; IP20 at terminals.

DMK00R1

- Voltage measurement range: 15...660VAC
- Operating frequency range: 45...65Hz
- Programmable VT ratio: 1.00...500.00
- Accuracy: ±0.25% f.s. ±1 digit

DMK01R1

- Current measurement range: 0.05...5.75A
- Operating frequency range: 45...65Hz
- Programmable CT ratio: 5...10,000
- Accuracy: ±0.5% f.s. ±1 digit

DMK02

- Voltage measurement range: 1...660VAC
- Current measurement range: 0.05...5.75A
- Operating frequency range: 45...65Hz
- Programmable VT ratio: 1.00...500.00
- Programmable CT ratio: OFF/5...10,000
- Accuracy: Voltage ±0.25% f.s. ±1 digit
Current ±0.5% f.s. ±1 digit

Control and protection functions

DMK00R1

- Voltage loss or failure: OFF/5...85%
- Maximum voltage: OFF/102...120%
- Minimum voltage: OFF/70...98%
- Time delay for max-min voltage or voltage lossⓂ: 0.0...900.0 seconds.

DMK01R1

- Current loss: OFF/2...100%
- Maximum current: OFF/102...200%
- Maximum current instantaneous tripping: OFF/110...600%
- Minimum current: OFF/5...98%
- Time delay for max-min current or current lossⓂ: 0.0...900.0 seconds.

Certifications and compliance

Certifications obtained: UL Listed, for USA and Canada (cULus - File E93601), as Auxiliary Devices-Multimeters; EAC. Compliant with standards: IEC/EN/BS 61010-1, IEC/EN/BS 61000-6-2, IEC/EN/BS 61000-6-3, UL508, CSA C22.2 n° 14.

Ⓜ Independent adjustable delays.

Flush-mount LED instruments three-phase, non expandable



DMK1...

Order code	Displayed measurements	Relay output	Qty per pkg	Wt [kg]
	n°	n°	n°	[kg]
Voltmeter.				
DMK10R1 Ⓜ	3 phase voltage values 3 phase to phase voltage values 3 maximum phase voltage values 3 maximum phase to phase voltage values 3 minimum phase voltage values 3 minimum phase to phase voltage values	1	1	0.330
Ammeter.				
DMK11R1 Ⓜ	3 phase current values 3 maximum phase current values 3 minimum phase current values	1	1	0.336
Voltmeter, ammeter and wattmeter.				
DMK15R1 ⓂⓂ	3 phase voltage values 3 phase to phase voltage values 3 phase current values 4 active power values, phase and total 3 maximum phase voltage values 3 maximum phase to phase voltage values 3 maximum phase current values 4 maximum active power values, phase and total 3 minimum phase voltage values 3 minimum phase to phase voltage values 3 minimum phase current values 4 minimum active power values, phase and total	1	1	0.350

① Connection also to single-phase.

Ⓜ Relay output for control and protection functions.

General characteristics

The DMK1... instruments are available with flush-mount housing, 96x48mm/3.78x1.89".

Measurements are True RMS values and provide for reliable operation even in the presence of harmonics.

Operational characteristics

- Auxiliary supply voltage: 220...240VAC;
- Operating frequency: 50...60Hz
- True RMS measurements
- Max and min measurement storage
- 1 relay output with 1 changeover contact
- Housing: flush-mount 96x48mm/3.78x1.89"
- Terminals: 4mm²
- Degree of protection: IP54 on front; IP20 at terminals.

DMK10R1

- Voltage measurement range: 15...660VAC
- Operating frequency range: 45...65Hz
- Programmable VT ratio: 1.00...500.00
- Accuracy: ±0.25% f.s. ±1 digit.

DMK11R1

- Current measurement range: 0.05...5.75A
- Operating frequency range: 45...65Hz
- Programmable CT ratio: 5...10,000
- Accuracy: ±0.5% f.s. ±1 digit.

DMK15R1

- Voltage measurement range: 35...660VAC
- Current measurement range: 0.05...5.75A
- Frequency measure range: 45...65Hz
- Programmable VT ratio: 1.00...500.00
- Programmable CT ratio: 5...10,000
- Accuracy: Voltage ±0.25% f.s. ±1 digit
Current ±0.5% f.s. ±1 digit
Power ±1% f.s. ±1 digit.

Control and protection functions

DMK10R1

- Phase loss or failure: OFF/5...85%
- Maximum voltage: OFF/102...120%
- Minimum voltage: OFF/70...98%
- Asymmetry: OFF/2...20%
- Phase sequence: OFF/L1-L2-L3/L3-L2-L1
- Frequency
 - Maximum frequency: OFF/101...110%
 - Minimum frequency: OFF/90...99%
 - Time delay for max-min voltage, phase loss, asymmetry and min-max frequency Ⓜ: 0.5...900.0 seconds.

DMK11R1

- Current loss: OFF/2...100%
- Maximum current: OFF/102...200%
- Maximum current instantaneous tripping: OFF/110...600%
- Minimum current: OFF/5...98%
- Asymmetry: OFF/2...20%
- Time delay for max-min current or current loss and asymmetry Ⓜ: 0.5...900.0 seconds.

DMK15R1

- Voltage
 - Phase loss or failure: OFF/5...85%
 - Maximum voltage: OFF/102...120%
 - Minimum voltage: OFF/70...98%
 - Asymmetry: OFF/2...20%
 - Phase sequence: OFF/L1-L2-L3/L3-L2-L1
- Current
 - Current loss: OFF/5...85%
 - Maximum current: OFF/102...200%
 - Maximum current instantaneous tripping: OFF/110...600%
 - Minimum current: OFF/5...98%
 - Asymmetry: OFF/2...20%
- Power
 - Rated power: 1...10,000
 - Maximum power: OFF/101...200%
 - Max. power instantaneous tripping: OFF/110...600%
 - Minimum power: OFF/10...99%
- Frequency
 - Maximum frequency: OFF/101...110%
 - Minimum frequency: OFF/90...99%
 - Time delay for max-min voltage, max-min current or current loss, phase loss, asymmetry and min-max power Ⓜ: 0.0...900.0 seconds.

Certifications and compliance

Certifications obtained: UL Listed, for USA and Canada (cULus - File E93601), as Auxiliary Devices-Multimeters; EAC. Compliant with standards: IEC/EN/BS 61010-1, IEC/EN/BS 61000-6-2, IEC/EN/BS 61000-6-3, UL 508, CSA C22.2 n° 14.

Ⓜ Independent adjustable delays.

Flush-mount LED multimeter three-phase, non expandable



DMK16R1

Order code	Displayed measurements	Relay output	Qty per pkg	Wt [kg]
DMK16R1 ①	3 phase voltage values 3 phase to phase voltage values 3 phase current values 4 active power values, phase and total 4 reactive power values, phase and total 4 apparent power values, phase and total 3 phase power factor values 1 frequency value 1 active energy value in kWh 1 reactive energy value in kvarh 1 hour counter 3 maximum phase voltage values 3 maximum phase to phase voltage values 3 maximum phase current values 4 maximum active power values, phase and total 4 maximum reactive power values, phase and total 4 maximum apparent power values, phase and total 3 minimum phase voltage values 3 minimum phase to phase voltage values 3 minimum phase current values 4 minimum active power values, phase and total 4 minimum reactive power values, phase and total 4 minimum apparent power values, phase and total 2 minimum and maximum power factor values	1	1	0.353

① Connection also to single-phase.

General characteristics

The DMK16R1 multimeter is available with flush-mount housing, 96x48mm/3.78x1.89"
 Measurements are True RMS values and provide for reliable operation even in the presence of harmonics.

Operational characteristics

- Auxiliary supply voltage: 220...240VAC
- Operating frequency: 50...60Hz
- True RMS measurements
- Accuracy: Voltage $\pm 0.25\%$ f.s. ± 1 digit
 Current $\pm 0.5\%$ f.s. ± 1 digit
- Active energy accuracy: Class 2 (IEC/EN/BS 62053-21 and IEC/EN/BS 62053-23)
- Max and min measurement storage
- Voltage measurement range: 35...660VAC
- Current measurement range: 0.05...5.75A
- Frequency measurement range: 45...65Hz
- Programmable VT ratio: 1.00...500.0
- Programmable CT ratio: 5...10,000
- 1 relay output with 1 changeover (SPDT) contact
- Housing: flush-mount 96x48mm/3.78x1.89"
- Terminals: 4mm²
- EN degree of protection: IP54 on front; IP20 at terminals.

PROGRAMMABLE RELAY OUTPUT

- Voltage
 - Phase loss or failure: OFF/5...85%
 - Maximum voltage: OFF/102...120%
 - Minimum voltage: OFF/70...98%
 - Asymmetry: OFF/2...20%
 - Phase sequence: OFF/L1-L2-L3/L3-L2-L1
- Current
 - Protection inhibition max current: OFF/2...100%
 - Maximum current: OFF/102...200%
 - Maximum current instantaneous tripping: OFF/110...600%
 - Minimum current: OFF/5...98%
 - Asymmetry: OFF/2...20%
- Power factor
 - Maximum power factor: 0.10...1.00
 - Minimum power factor: 0.10...1.00
- Time delay for max-min voltage, max-min current or current loss, phase loss, asymmetry and min-max power factor ②: 0.0...900.0 seconds.

Certifications and compliance

Certifications obtained: UL Listed, for USA and Canada (cULus - File E93601), as Auxiliary Devices-Multimeters; EAC. Compliant with standards: IEC/EN/BS 61010-1, IEC/EN/BS 61000-6-2, IEC/EN/BS 61000-6-3, UL508, CSA C22.2 n° 14.

② Independent adjustable delays.

Communication devices



CX01



CX02



CX03

Order code	Description	Qty per pkg	Wt
		n°	[kg]
CX01	USB/optical device with PC ↔ LOVATO Electric product connecting cable, for programming, data download, diagnostics and firmware upgrade	1	0.090
CX02	Wi-Fi device for PC ↔ LOVATO Electric product programming, data download, diagnostics and cloning	1	0.090
CX03	GSM/GPRS penta-band antenna (850/900/1800/1900/2100MHz)	1	0.090

General characteristics

Communication devices for connection of LOVATO Electric products to personal computers, smartphones and tablets.

CX01

The USB/optical device, complete with cable, allows the connection of products compatible with PCs without having to disconnect the power supply from the electric panel. The PC identifies the connection as a standard USB.

CX02

By Wi-Fi connection, compatible LOVATO Electric products can be viewed on PCs, smartphones and tablets with no need for cabling.

CX03

Antenna compatible with the major part of worldwide mobile networks thanks to the available frequencies at 850/900/1800/1900/2100MHz.

Degree of protection: IP67. Fixing by Ø10mm drilling. Cable length: 2.5mm

Protection covers



PA96X48

Order code	Description	Qty per pkg	Wt
		n°	[kg]
PA96X48	Front protection cover, IEC IP65 for DMK0/1...	1	0.048

General characteristics

When a higher front IP protection degree is needed, the covers can be installed on the corresponding devices and also provide a sealing feature.

Accessories



EXP8000



EXM8004

new

Order code	Description	Qty per pkg	Wt
		n°	[kg]
EXP8000	Plastic insert for customising label fixing for DMG6...	10	0.005
EXM8004	Set of sealable terminal covers for DMG100/110/200/210/300	1	0.020
DMXP03	Panel mounting plate adapter for 3 modules products	1	0.052
DMXP04	Panel mounting plate adapter for 4 modules products	1	0.054



DMXP03



DMXP04

Converter



EXCCON01

Order code	Description	Qty per pkg	Wt
		n°	[kg]
EXCCON01	RS485/Ethernet 12...48VDC converter, including DIN rail fixing kit	1	0.400

General characteristics EXCCON01

The EXCCON01 converter allows "Slave" devices connected on an RS485 network to interface with a "Master" featuring Ethernet port:

- kit comprising converter and DIN rail mounting accessory;
- programming via web interface;
- power supply not included.

Certifications

Certifications obtained: cULus (UL 60950-1) Listed FCC CLASS A.

Gateway



EXCGLA01



EXCGLAX1



EXCM4G01

new

Order code	Description	Qty per pkg	Wt
		n°	[kg]
EXCGLA01	Gateway data logger for the data collecting via Modbus from the device in the field. Publishing of the data to supervision software, also in Cloud	1	0.600
EXCGLAX1	2G/4G modem communication module for EXCGLA01	1	0.160
EXCM4G01	4G Gateway with RS485 and Ethernet port, Modbus RTU/TCP protocol	1	0.300

EXCGLA01 and EXCGLAX1 general characteristics

EXCGLA01 gateway is able to collect data from devices which are connected through Ethernet or RS485 port. Modbus-RTU, ASCII and TCP protocols are supported. The data can be reviewed by a connection to Synergy Cloud service or to Ethernet local webserver and a browser. The access to internet for data sending can be achieved with Ethernet port or by adding EXCGLAX1 2G/4G modem.

- CPU ARM 1 GHz
- 2 Ethernet ports
- 1 RS232/RS422/RS485 serial port
- 24VDC (10...32VDC) power supply
- Operating temperature -20...+60°C
- Simplified connection to LOVATO Electric devices
- Compatible with Synergy and Synergy cloud software.
- LTE cat. 4 Global support, UMTS/DC HS DPA/HSUPA/WCDMA, GSM/GPRS/EDGE
- SIM slot for microSIM.

Reference standards

Compliant with standards: EN 60950-1.

EXCM4G01 general characteristics

The EXCM4G01 gateway allows "Slave" devices connected on an RS485 network to interface with a "Master" via 4G network:

- TCP server connection via 4G or 2G network;
- Transparent operating mode: the data is transferred from 4G side to serial side and vice versa with Modbus-RTU/TCP protocol conversion;
- Settable parameters: TCP server IP and remote port, network operator apn (with username and password), SIM card pin (with enabling), connection time-out, serial parameters (baud rate from 1,200 bps to 115,200 bps, stop bit, character length, parity)
- Programming via integrated webserver.

Reference standards

Compliant with standards for EXCGLA01: emissions EN/BS 61000-6-4, immunity EN/BS 61000-6-2, for installation in industrial environment.

Compliant with standards for EXCGLAX1: EN/BS 61000-6-4, EN/BS 61000-6-2, EN/BS 61000-6-3, EN/BS 61000-6-1, EN/BS 60945, ETSI EN/BS 301 489-1, ETSI EN/BS 301 489-52, EN/BS 301 511, ETSI EN/BS 301 908-1, ETSI EN/BS 301 908-2, EN/BS 62311, EN/BS 60950-1.

Compliant with standards for EXCM4G01: EN 60950-1.

For dimensions, wiring schemes and technical characteristics, refer to technical instructions in Downloads at www.LovatoElectric.com.

Connecting cable



51C2

Order code	Description	Qty per pkg.	Wt
		n°	[kg]
51C2	For PC-multimeter RS232 port, 1.8m long	1	0.090

Wound primary type



DMOTW...

new

Order code	Primary current I _{pn}	Burden			Qty per pkg	Wt [kg]
		cl. 0.5 [VA]	cl. 1 [VA]	cl. 3 [VA]		
	/5 [A]	[VA]	[VA]	[VA]	n°	[kg]

Screw primary terminals.

DMOTW0005	5	1.5	2.5	—	1	0.525
DMOTW0010	10	1.5	2.5	—	1	0.525
DMOTW0020	20	1.5	2.5	—	1	0.525
DMOTW0030	30	1.5	2.5	—	1	0.525

Solid-core



DMOT...

new

Order code	Primary current I _{pn}	Burden			Qty per pkg	Wt [kg]
		cl. 0.5 [VA]	cl. 1 [VA]	cl. 3 [VA]		
	/5 [A]	[VA]	[VA]	[VA]	n°	[kg]

For Ø22mm/0.87" cable.

DMOT0040	40	—	—	1.25	1	0.200
DMOT0050	50	—	1.25	—	1	0.200
DMOT0060	60	—	1.5	—	1	0.200
DMOT0080	80	—	1.5	—	1	0.200
DMOT0100	100	—	1.5	—	1	0.200
DMOT0150	150	—	2	—	1	0.200



DM2T...

Order code	Primary current I _{pn}	Burden		Qty per pkg.	Wt [kg]
		cl. 0.5 [VA]	cl. 1 [VA]		
	/5 [A]	[VA]	[VA]	n°	[kg]

For Ø23mm/0.90" cable.
For 30x10mm/1.18x0.39", 25x12.5mm/0.98x0.49",
20x15mm/0.79x0.59" busbars, width 52mm/2.05".

DM2T0100	100	—	1	1	0.130
DM2T0150	150	—	1.5	1	0.130
DM2T0200	200	—	2	1	0.130
DM2T0250	250	—	2.5	1	0.130
DM2T0300	300	1.5	3	1	0.130
DM2T0400	400	2	3	1	0.130

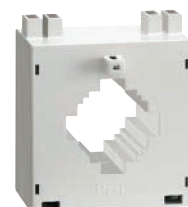

DM3T...

Order code	Primary current I _{pn}	Burden		Qty per pkg.	Wt [kg]
		cl. 0.5 [VA]	cl. 1 [VA]		
	/5 [A]	[VA]	[VA]	n°	[kg]

For Ø30mm/1.18" cable.
For 40x10mm/1.57x0.39", 30x20mm/1.18x0.79",
25x25mm/0.98x0.98" busbars, width 71mm/2.79".

DM3T0200	200	—	5	1	0.260
DM3T0250	250	—	5	1	0.260
DM3T0300	300	2.5	5	1	0.260
DM3T0400	400	2.5	5	1	0.260
DM3T0500	500	2.5	5	1	0.260
DM3T0600	600	5	10	1	0.260
DM3T0800	800	5	10	1	0.260

new

Order code	Primary current I _{pn}	Burden		Qty per pkg.	Wt [kg]
		cl. 0.5 [VA]	cl. 1 [VA]		
	/5 [A]	[VA]	[VA]	n°	[kg]

For Ø44mm/1.73" cable.
For 51x41mm/2.01x1.61", 61x31mm/2.40x1.22" busbars,
width 95mm/3.74".

DM33T0800	800	5	10	1	0.476
DM33T1000	1000	5	15	1	0.476
DM33T1200	1200	5	15	1	0.476

new

Order code	Primary current I _{pn}	Burden		Qty per pkg.	Wt [kg]
		cl. 0.5 [VA]	cl. 1 [VA]		
	/5 [A]	[VA]	[VA]	n°	[kg]

For Ø44mm/1.73" cable.
For 69x10mm/2.72x0.39", 50x30mm/1.97x1.18" busbars,
width 95mm/3.74".

DM34T1500	1500	5	15	1	0.476
DM34T1600	1600	5	15	1	0.476

General characteristics

The current transformers (CTs) in the DM series are installed in an electrical system to reduce the line current to a secondary value of 5A compatible with the ammeter inputs of the digital multimeters or protection relays.

DMOTW... are instrument transformers in class 1/0.5 wound primary type and are normally used for low primary current values starting from 5A.

DM... are instrument transformers in class 1/0.5 without a primary winding and are normally used for high primary current values starting from 40A.

The number of loops of the primary cable does not modify the accuracy but converts the primary current value proportional to secondary current.

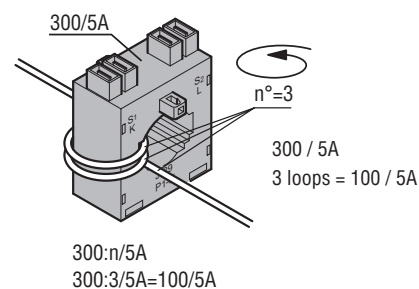
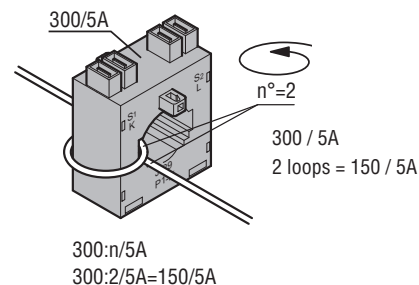
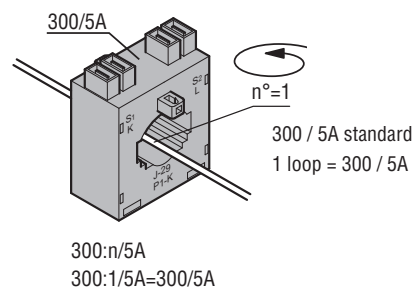

Operational characteristics

- Operating frequency: 50...60Hz
- Secondary output current: 5A
- Overload withstand: 120% I_{pn}
- IEC rated insulation voltage U_i: 720V
- IEC rated short-time thermal current I_{th}: 40...60 I_{pn} for 1 second
- IEC rated dynamic current I_{dyn}: 2.5 I_{th} for 1 second
- Insulation (dry type): Class E
- Terminals:

- Faston for DM2T... and DM3T... types
- Screw for DMOT... types
- Sealable terminal covers for DM4T..., DM33T, DM34T and DM35T... types
- Fixing on 35mm DIN rail (IEC/EN/BS 60715) or by screws (fixing elements standard supplied with the product)
- EN degree of protection: IP30
- Ambient conditions:
 - Operating temperature: -25...+50°C
 - Storage temperature: -40...+80°C
 - Relative humidity, non condensing: 90%.

Certifications and compliance

Certifications obtained: EAC.
Compliant with standards: IEC/EN/BS 61869-2,
IEC/EN/BS 61869-1.

Solid-core



DM35T...



DM4T...

new

new

Order code	Primary current I _{pn}	Burden		Qty per pkg.	Wt [kg]
		cl. 0.5 [VA]	cl. 1 [VA]		

For Ø66mm/2.60" cable.
For 80x12,5mm/3.15"x0.49", 60x30mm/2.36x1.18", 50x50mm/1.97x1.97" busbars, width 105mm/4.13".

DM35T0400	400	—	5	1	0.460
DM35T0500	500	5	5	1	0.460
DM35T0600	600	5	10	1	0.460
DM35T0800	800	10	15	1	0.460
DM35T1000	1000	15	20	1	0.460
DM35T1250	1250	15	20	1	0.460

For 101x56mm/3.98x2.20" busbars, width 128mm/5.04".

DM37T2000	2000	10	15	1	1.000
DM37T2250	2250	10	15	1	1.000
DM37T2500	2500	10	15	1	1.000
DM37T3000	3000	10	15	1	1.000

For Ø86mm/3.38" cable.
For 100x30mm/3.94x1.18", 80x50mm/3.15x1.97", 70x60mm/2.75x2.36" busbars, width 140mm/5.51".

DM4T1000	1000	10	20	1	0.700
DM4T1250	1250	15	30	1	0.760
DM4T1500	1500	20	30	1	0.760
DM4T1600	1600	20	30	1	0.800
DM4T2000	2000	30	45	1	0.840
DM4T2500	2500	35	45	1	0.900
DM4T3000	3000	45	45	1	0.900
DM4T3500	3500	50	50	1	0.900
DM4T4000	4000	50	50	1	0.900

General characteristics

The current transformers (CTs) in the DM series are installed in an electrical system to reduce the line current to a secondary value of 5A compatible with the ammeter inputs of the digital multimeters or protection relays.

DM... are instrument transformers in class 1/0.5 without a primary winding and are normally used for high primary current values starting from 50A.

The number of loops of the primary cable does not modify the accuracy but converts the primary current value proportional to secondary current.

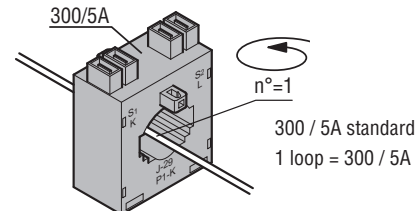

300:n/5A
300:1/5A=300/5A

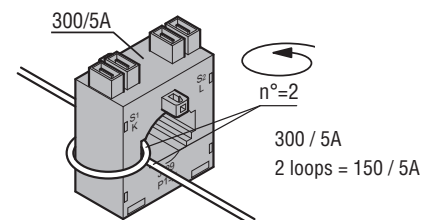

300:n/5A
300:2/5A=150/5A

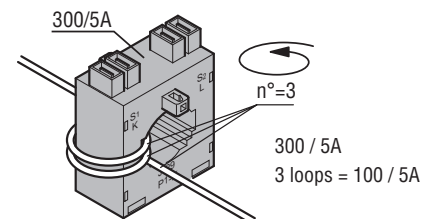

300:n/5A
300:3/5A=100/5A

Operational characteristics

- Operating frequency: 50...60Hz
- Secondary output current: 5A
- Overload withstand: 120% I_{pn}
- IEC rated insulation voltage U_i: 720V
- IEC rated short-time thermal current I_{th}: 40...60 I_{pn} for 1 second
- IEC rated dynamic current I_{dyn}: 2.5 I_{th} for 1 second
- Insulation (dry type): Class E
- Terminals:
 - Screw for DM4T... and DM35T... types
- Sealable terminal covers for DM4T..., DM35T... and DM37T... types
- Fixing on 35mm DIN rail (IEC/EN/BS 60715) or by screws (fixing elements standard supplied with the product)
- EN degree of protection: IP30
- Ambient conditions:
 - Operating temperature: -25...+50°C
 - Storage temperature: -40...+80°C
 - Relative humidity, non condensing: 90%.

Certifications and compliance

Certifications obtained: EAC.
Compliant with standards: IEC/EN/BS 61869-2, IEC/EN/BS 61869-1.

Accuracy solid-core



DM1TP...



DM3TP...



DM4TP...

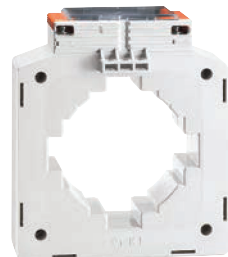

DM5TP...

Version with UTF certificates.
See page 25-17.

Order code	Primary current I _p /5 [A]	Burden		Qty per pkg n°	Weight [kg]
		cl. 0.5s [VA]	cl. 0.5 [VA]		

For Ø28mm/1.10" cable.
For 30x10mm/1.18x0.39", 25x12.5mm/0.98x0.49",
20x20mm/0.79x0.79" busbar, width: 75mm/2.95".

DM1TP0060	60	1.5	1.5	1	0.560
DM1TP0080	80	2.5	2.5	1	0.580
DM1TP0100	100	2.5	3.75	1	0.480
DM1TP0150	150	2.5	3.75	1	0.480
DM1TP0200	200	2.5	3.75	1	0.480
DM1TP0250	250	2.5	5	1	0.480
DM1TP0300	300	2.5	5	1	0.480
DM1TP0400	400	5	5	1	0.480
DM1TP0500	500	5	5	1	0.480

For Ø28mm/1.10" cable.
For 30x10mm/1.18x0.39", 25x20mm/0.98x0.79",
20x20mm/0.79x0.79" busbar, width: 75mm/2.95".

new

DM1TP0600	600	2.5	5	1	0.480
-----------	-----	-----	---	---	-------

For Ø52mm/2.04" cable.
For 60x20mm/2.36x0.79", 50x25mm/1.97x0.98" busbar,
width: 101mm/3.98".

DM3TP0500	500	3.75	5	1	0.700
DM3TP0600	600	5	10	1	0.700
DM3TP0800	800	5	10	1	0.700
DM3TP1000	1000	5	10	1	0.700

new

For Ø80mm/3.15" cable.
For 82x30mm/3.23x1.18" busbar, width: 128mm/5.04".

DM4TP1200	1200	-	10	1	0.800
-----------	------	---	----	---	-------

For Ø85.5mm/3.37" cable.
For 100x20mm/3.94x0.79", 80x45mm/3.15x1.77" busbar,
width: 144mm/5.67".

DM5TP1000	1000	5	10	1	0.900
DM5TP1250	1250	7.5	10	1	0.900
DM5TP1600	1600	7.5	10	1	0.900
DM5TP2000	2000	10	15	1	0.900
DM5TP2500	2500	10	15	1	0.900
DM5TP3000	3000	10	15	1	0.900

Consult Technical support to inquiry about versions with Italian UTF certificates.

General characteristics

The DM...TP type accuracy current transformers (CTs) are installed in an electrical system to reduce the line current to a secondary value of 5A compatible with the ammeter inputs of the digital multimeters or protection relays.

DM...TP are accuracy current transformers in class 0.5s without a primary winding and are normally used for high primary current values starting from 60A.

The number of loops of the primary cable does not modify the accuracy but converts the primary current value proportional to secondary current.

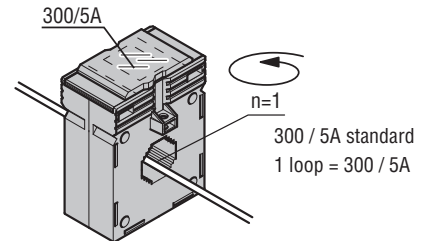

300:n/5A
300:1/5A=300/5A

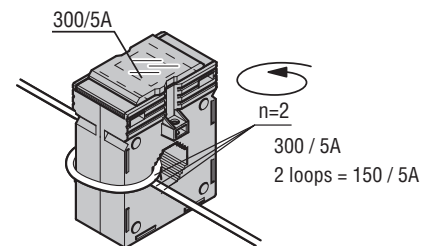

300:n/5A
300:3/5A=100/5A

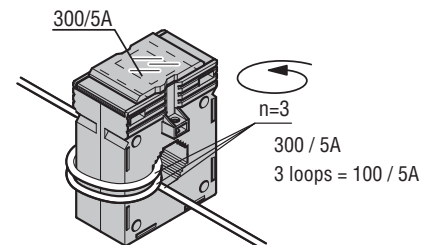

300:n/5A
300:3/5A=100/5A

Operational characteristics

- Operating frequency: 50...60Hz
- Secondary output current: 5A
- Overload withstand: 120% I_n
- IEC rated insulation voltage U_i: 720V
- IEC rated short-time thermal current I_{th}: 40...60 I_n for 1 second
- IEC rated dynamic current I_{dyn}: 2.5 I_{th} for 1 second
- Insulation (dry type): Class E
- Screw terminals
- Sealable terminal covers
- Fixing on 35mm DIN rail (IEC/EN/BS 60715) or by screws (fixing elements standard supplied with the product)
- EN degree of protection: IP30
- Ambient conditions:
 - Operating temperature: -25...+50°C
 - Storage temperature: -40...+80°C
 - Relative humidity, non condensing: 90%.

Certifications and compliance

Certifications obtained: EAC.
Compliant with standards: IEC/EN/BS 61869-2,
IEC/EN/BS 61869-1.

Compact prewired split-core



DM1TMA...



DM2TMA...

new

Order code	Primary current I _{pn} /5 [A]	Burden		Qty per pkg. n°	Weight [kg]
		cl. 0.5 [VA]	cl. 1 [VA]		
24x24mm/0.94x0.94" hole. Cable supplied as standard, length 2m.					
DM1TMA0100	100	—	1.0	1	0.200
DM1TMA0150	150	—	1.0	1	0.200
DM1TMA0200	200	—	1.0	1	0.200
DM1TMA0250	250	—	1.0	1	0.200
36x38mm/1.42x1.50" hole. Cable supplied as standard, length 2m.					
DM2TMA0250	250	0.5	1.5	1	0.380
DM2TMA0300	300	0.5	1.5	1	0.380
DM2TMA0400	400	0.5	1.5	1	0.380
DM2TMA0500	500	0.5	1.5	1	0.380
DM2TMA0600	600	0.5	1.5	1	0.380

General characteristics

The DM...TMA type current transformers (CTs) are installed in an electrical system to reduce the line current to a secondary value of 5A compatible with the ammeter inputs of the digital multimeters or protection relays.

DM...TMA are instrument transformers in class 1 without a primary winding and are normally used for high primary current values starting from 100A.

Operational characteristics

- Operating frequency: 50...60Hz
- Secondary output current: 5A
- Overload withstand: 120% I_{pn}
- IEC rated insulation voltage U_i: 720V
- IEC rated short-time thermal current I_{th}: 40...60 I_{pn} for 1 second
- IEC rated dynamic current I_{dyn}: 2.5 I_{th} for 1 second
- Cable supplied as standard, length 2m.
- Insulation (dry type): Class E
- Ambient conditions:
 - Operating temperature: -25...+50°C
 - Storage temperature: -40...+80°C
 - Relative humidity, non condensing: 90%.

Certifications and compliance

Certifications obtained: EAC.
Compliant with standards: IEC/EN/BS 61869-2, IEC/EN/BS 61869-1.

Split-core



DM1TA...

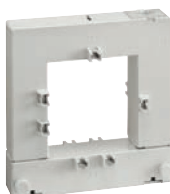

DM2TA...



DM3TA...



DM4TA...

new

Order code	Primary current I _{pn}	Burden			Qty per pkg	Wt [kg]
		cl. 0,5	cl. 1	cl. 3		

32x21mm/1.26x0.83" hole. Width: 89mm/3.50"

DM0TA0100	100	—	—	1	1	0.900
DM0TA0150	150	—	1	2.5	1	0.900
DM0TA0200	200	—	2.5	—	1	0.900

50x80mm/1.97x3.15" hole. Width: 114mm/4.89"

DM1TA0250	250	1	2		1	0.900
DM1TA0300	300	1.5	3		1	0.900
DM1TA0400	400	1.5	3		1	0.900
DM1TA0500	500	2.5	5		1	0.900
DM1TA0600	600	2.5	5		1	0.900
DM1TA0800	800	3	7.5		1	0.900
DM1TA1000	1000	5	10		1	0.900

Order code	Primary current I _{pn}	Burden		Qty per pkg	Wt [kg]
		cl. 0.5s	cl. 0.5		

80x80mm/3.15x3.15" hole. Width: 142mm/5.59"

DM2TA0250	250	1	2	1	1.050
DM2TA0300	300	1.5	3	1	1.050
DM2TA0400	400	1.5	3	1	1.050
DM2TA0500	500	2.5	5	1	1.050
DM2TA0600	600	2.5	5	1	1.050
DM2TA0800	800	3	7.5	1	1.050
DM2TA1000	1000	5	10	1	1.050
DM2TA1250	1250	—	15	1	1.050

new

80x120mm/3.15x4.72" hole. Width: 142mm/5.59"

DM3TA0500	500	—	4	1	1.250
DM3TA0600	600	—	5	1	1.250
DM3TA0800	800	3	7.5	1	1.250
DM3TA1000	1000	5	10	1	1.250
DM3TA1250	1250	7.5	15	1	1.250
DM3TA1500	1500	8	17	1	1.250
DM3TA2000	2000	—	17	1	1.250

new

80x160mm/3.15x6.30" hole. Width: 184mm/7.24"

DM4TA2000	2000	15	20	1	3.160
DM4TA2500	2500	15	20	1	3.340
DM4TA3000	3000	20	25	1	3.500
DM4TA4000	4000	20	25	1	3.760

General characteristics

The DM...TA type current transformers (CTs) are installed in an electrical system to reduce the line current to a secondary value of 5A compatible with the ammeter inputs of the digital multimeters or protection relays.

DM...TA are instrument transformers in class 0.5/1 without a primary winding and are normally used for high primary current values starting from 250A.

Operational characteristics

- Operating frequency: 50...60Hz
- Secondary output current: 5A
- Overload withstand: 120% I_{pn}
- IEC rated insulation voltage U_i: 720V
- IEC rated short-time thermal current I_{th}: 40...60 I_{pn} for 1 second
- IEC rated dynamic current I_{dyn}: 2.5 I_{th} for 1 second
- Insulation (dry type): Class E
- Screw terminals
- Sealable terminal covers
- Screw fixing (fixing elements standard supplied with the product)
- IEC degree of protection: IP30
- Ambient conditions:
 - Operating temperature: -25...+50°C
 - Storage temperature: -40...+80°C
 - Relative humidity, non condensing: 90%.

Certifications and compliance

Certifications obtained: EAC.

Compliant with standards: IEC/EN/BS 61869-2, IEC/EN/BS 61869-1.

ENERGY METERS

Digital meter **DMED100...** - **DMED110...** - **DMED111...** - **DMED112...**

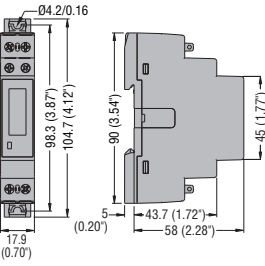

Digital meter **DMED115T1** - **DMED120T1...** - **DMED121** - **DMED122**

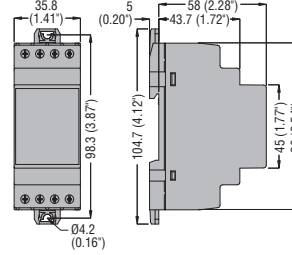

Digital meter **DMED305T2...** - **DMED330...** - **DMED332...** - **DMED310T2...** - Data concentrator **DMECD**

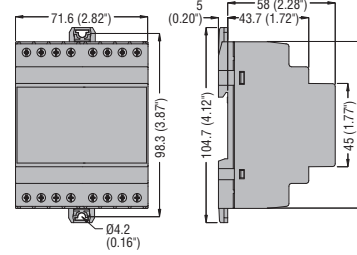

DMED300T2... - **DMED301...** - **DMED302...**

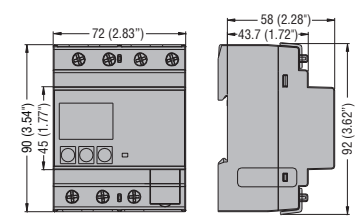

Digital meter **DMED130LM**

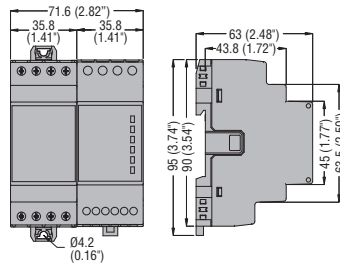

MULTIMETERS

DMG100 - **DMG110** - **DMG200** - **DMG210** - **DMG300**

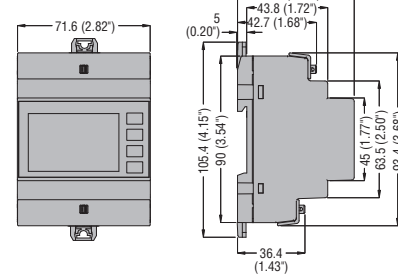

Expansion modules **EXM...**

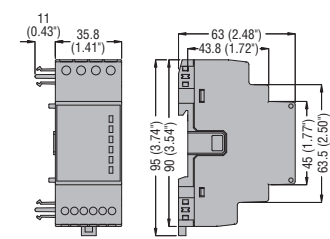

DMG6...

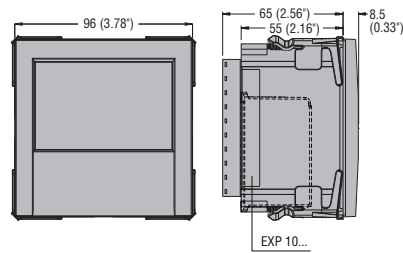

Cutout

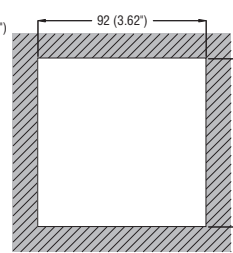

POWER ANALYZERS

DMG7000 - **DMG7500** - **DMG8000** - **DMG9000**

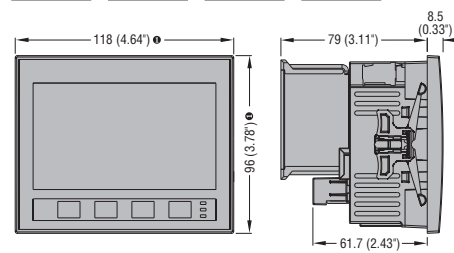

Cutout

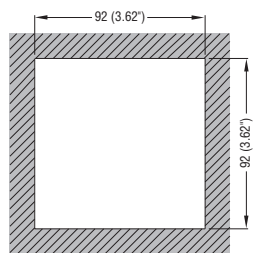

① Dimensions with gasket: 122x100mm/4.80x3.94".

CURRENT MEASURING MODULES

EXS4000

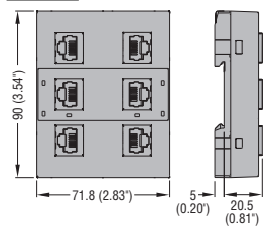

EXS4001

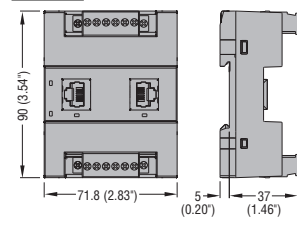

ELECTRONIC CURRENT TRANSFORMERS

EXS1032 - **EXS1063**

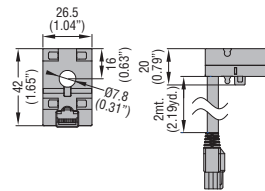

EXS1080 - **EXS1125**

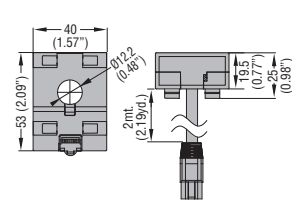

EXS3032 - **EXS3063**

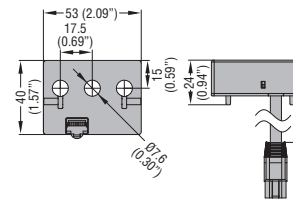

EXS3080 - **EXS3125**

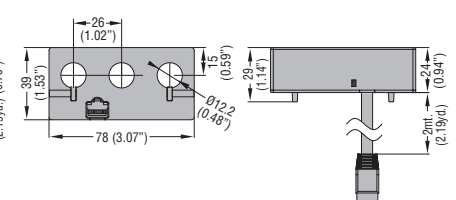

MODULAR DIGITAL METERING INSTRUMENTS

DMK7... - **DMK8...**

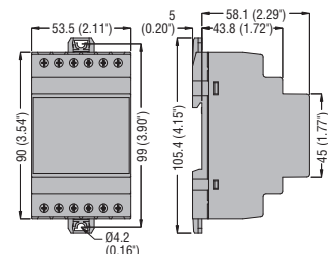

DIGITAL FLUSH-MOUNT METERING INSTRUMENTS

Instruments **DMK0...** - **DMK1...**

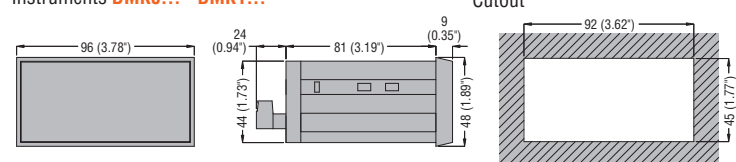

Cutout

CURRENT TRANSFORMERS
Wound primary **DM0TW...**

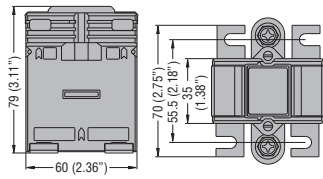

Solid core **DM0T...**

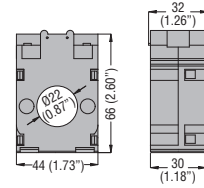

DM2T...

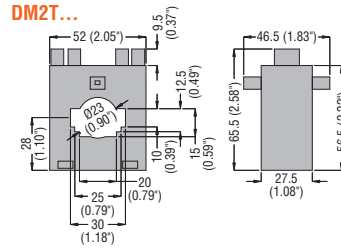

DM3T...

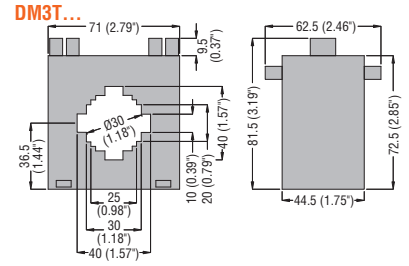

DM33T...

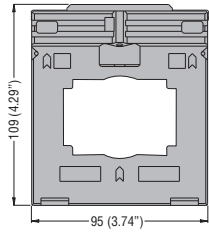

DM34T...

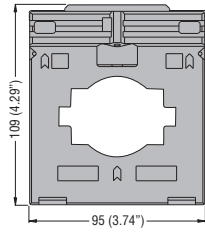

DM35T...

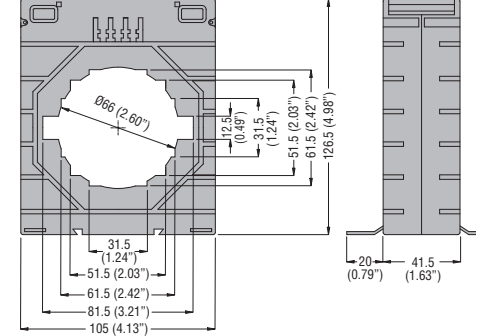

DM37T...

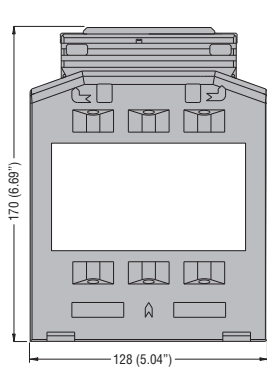

DM4T...

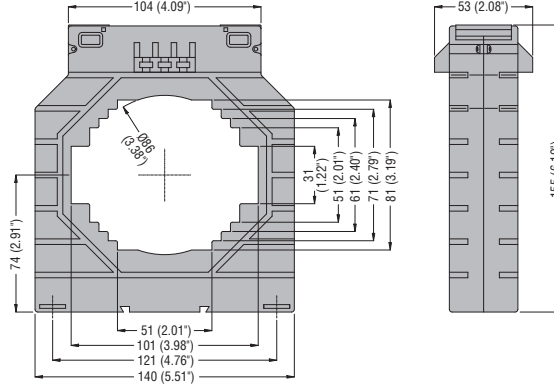

DM1TP0060... - DM1TP0300

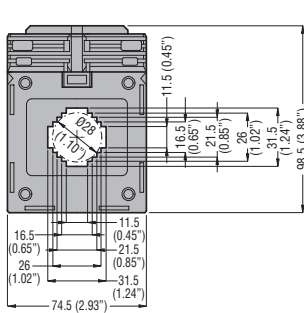

DM1TP0400... - DM1TP0600

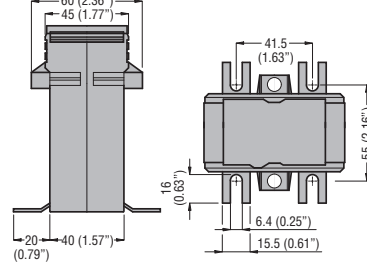
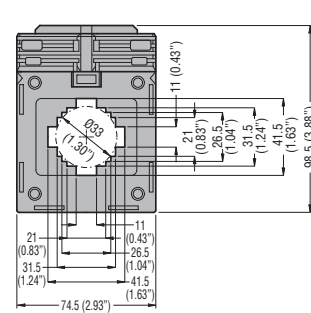

DM3TP...

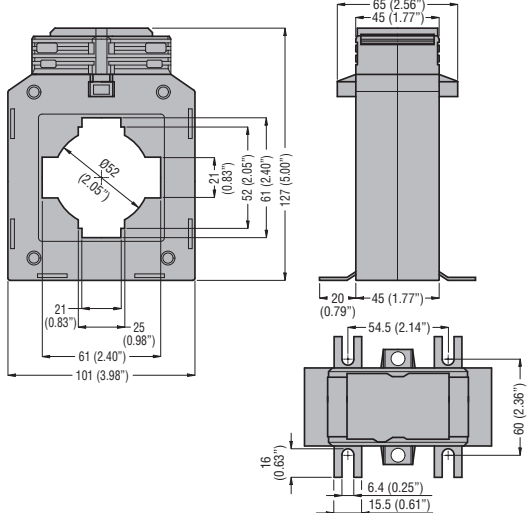

DM4TP1200

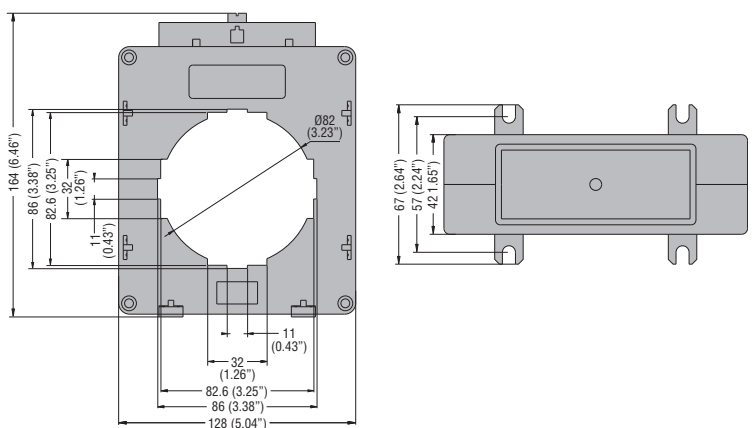

DM5TP...

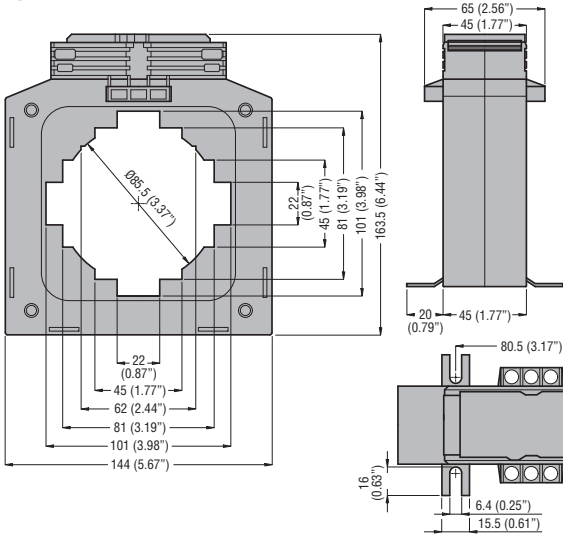

Compact prewired split-core

DM1TMA...

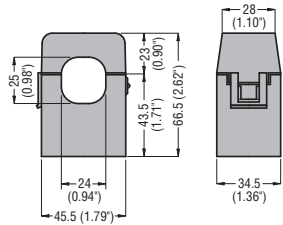

DM2TMA...

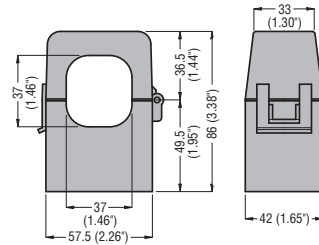

Split-core

DM0TA...

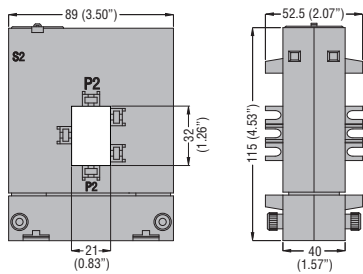

DM1TA...

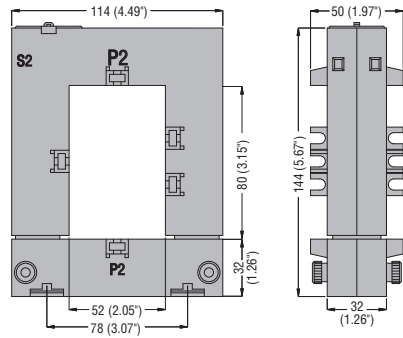

DM2TA...

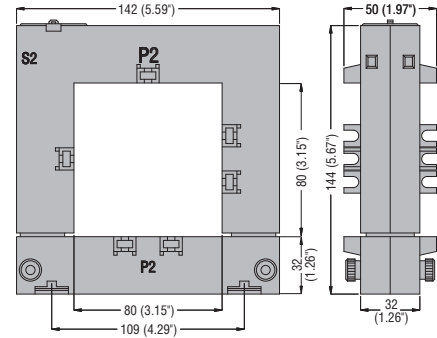

DM3TA...

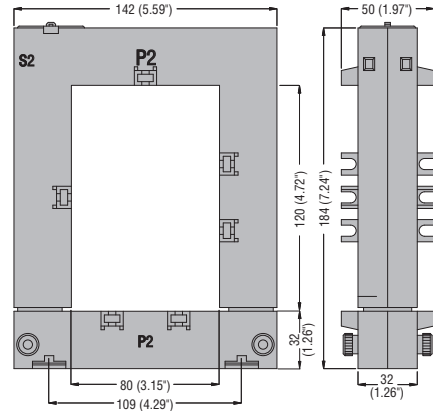

DM4TA...

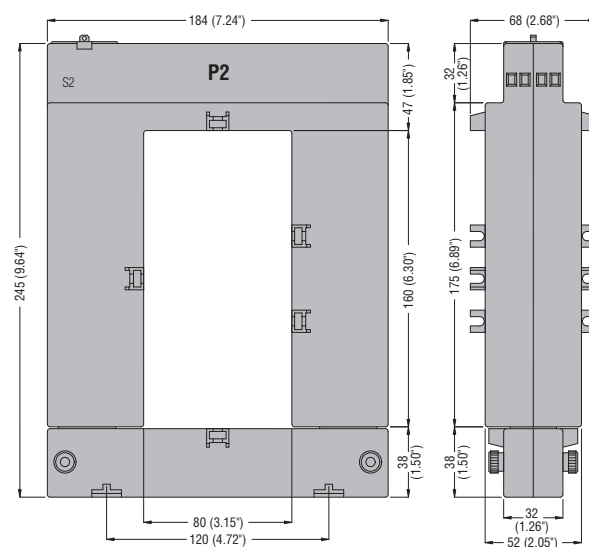

ENERGY METERS

DMED111...

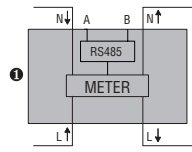

DMED112...

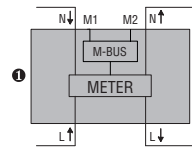

1 110-240VAC DMED111, DMED112...

Digital meters **DMED100T1... - DMED110T1...**

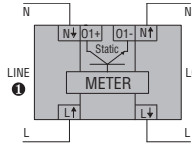

DMED115T1 - DMED120T1...

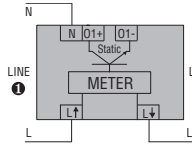

DMED121...

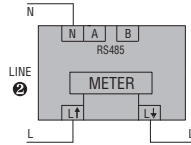

DMED122...

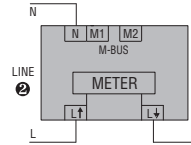

DMED130LM

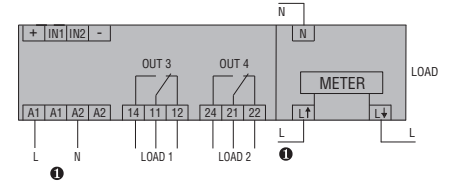

1 110-120VAC DMED...A120; 220-240VAC DMED...; 230V 50Hz DMED... T1 MID.
2 110-240VAC DMED121, DMED122...

DMED300T2... - DMED300F

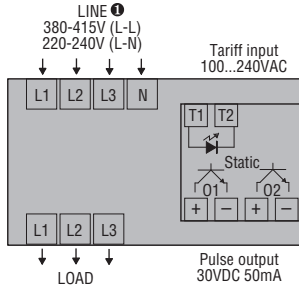

DMED310T2... - DMED310F...

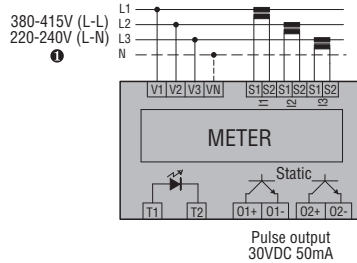

DMED301

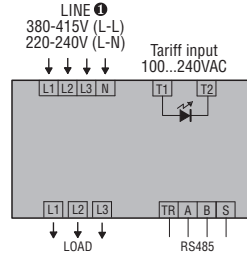

DMED302

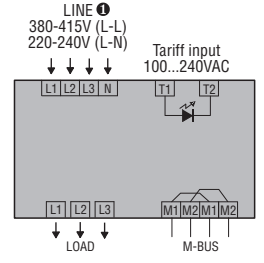

1 230V 50Hz (L-N), 400V 50Hz (L-L) DMED... T2 MID / DMED... F.

DMED305T2 - DMED330 - DMED332

Single-phase

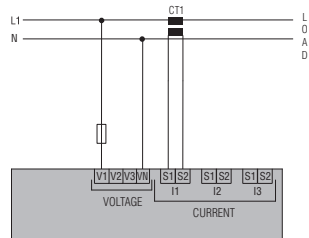

Two-phase

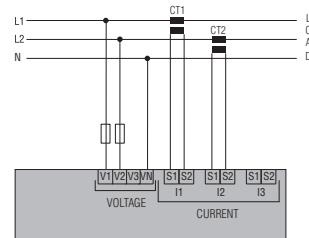

Three-phase with or without neutral

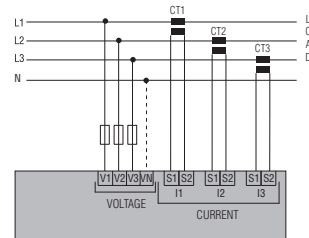

Three-phase without neutral in ARON connection

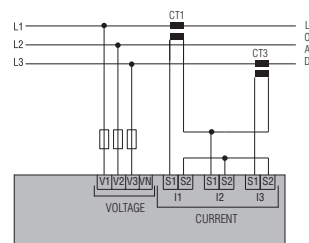
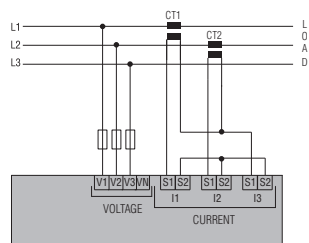

Tariff input



Pulse output 30VDC 50mA for DMED305T2

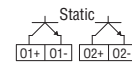

RS485 for DMED330



M-BUS for DMED332



Data concentrator **DMEDC**

100...240VAC
110...250VDC

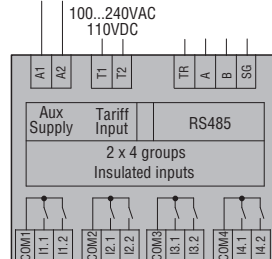

MULTIMETERS **DMG...** Single-phase

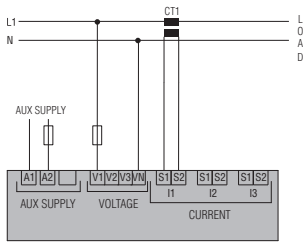

Two-phase

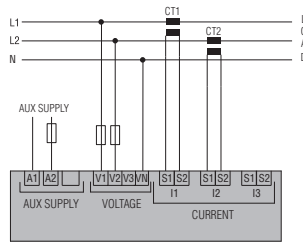

Three-phase with or without neutral

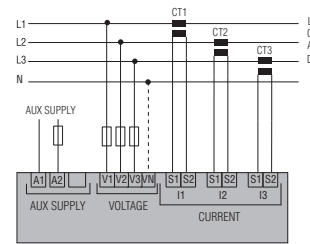

Three-phase without neutral in ARON connection

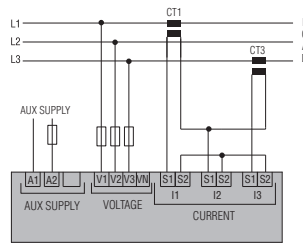
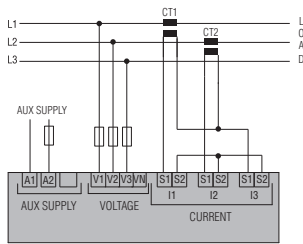

Balanced 3-phase connection with or without neutral

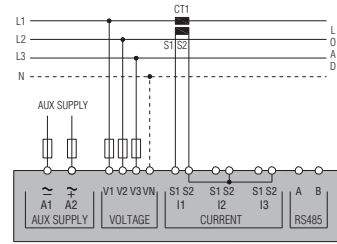

CODE	AUX SUPPLY
DMG100-110-200-210-300	100...240VAC 110...250VDC
DMG6...	100...440VAC 110...250VDC
DMG7000-7500-8000-9000	100...240VAC 110...250VDC

RS485 for DMG110 and DMG210



RS485 for DMG610



RS485 for DMG7500 and DMG9000



MULTIMETERS **DMG611...**

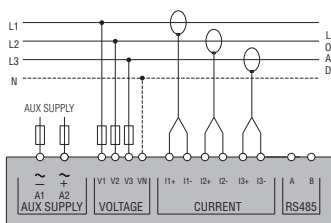

RS485 for DMG611



METERING INSTRUMENTS
DMK80R1

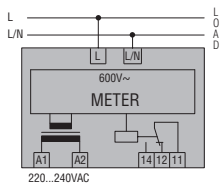

DMK81R1

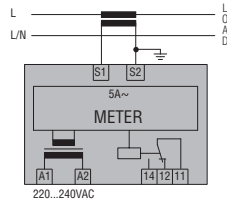

DMK70R1

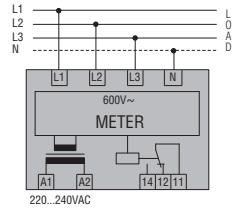

DMK71R1

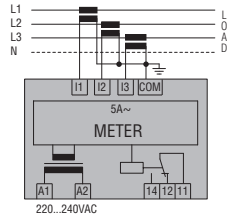

DMK75R1

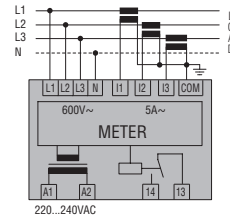

DMK00R1

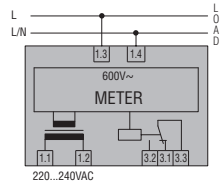

DMK01R1

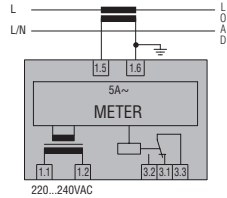

DMK02
Voltmeter

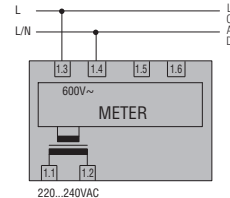

Ammeter

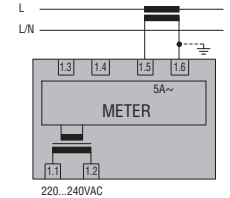

DMK10R1

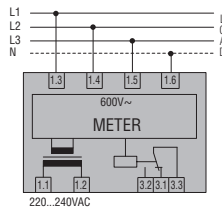

DMK11R1

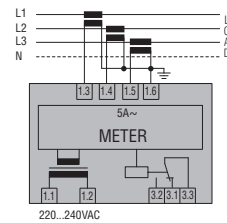

DMK15R1

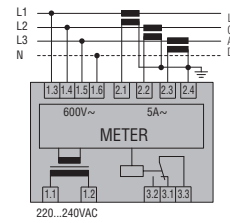

DMK16R1

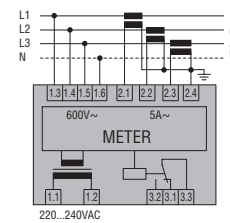

25 Metering instruments and current transformers

Technical characteristics
Single-phase energy meters



INDEX

TYPE	DMED100T1	DMED100T1A120	DMED100T1MID	DMED110T1	DMED110T1A120	
	Single-phase	Single-phase	Single-phase	Single-phase	Single-phase	
AUXILIARY SUPPLY						
Rated voltage(Ue)	220...240VAC	110...120VAC	230VAC	220...240VAC	110...120VAC	
Operating voltage range	187...264VAC	93...132VAC	187...264VAC	187...264VAC	93...132VAC	
Rated frequency	50/60Hz	60Hz	50Hz	50/60Hz	60Hz	
Maximum power consumption	7VA					
Maximum power dissipation	0.45W					
CURRENT						
IEC maximum current (Imax)	40A					
IEC minimum current (Imin)	0,25A					
IEC rated current (Iref-Ib)	5A					
IEC start current (Ist)	20mA					
Transition current (Itr)	0,5A					
ACCURACY						
Active energy (per IEC/EN/BS 62053-21)	Class 1		Class B (EN 50470-3)	Class 1		
OUTPUTS						
LED rate	1000 flash/kWh					
Pulse rate	1000 pulses/kWh					
Pulse duration	30ms					
STATIC OUTPUTS						
Pulse rate	10 pulses/kWh		1-10-100-1000 pulses/kWh programmable			
Pulse duration	100ms					
External voltage	10...30VDC					
Maximum current	50mA					
INSULATION						
IEC rated insulation voltage Ui	250VAC					
IEC rated impulse withstand voltage Uimp	6kV					
IEC power frequency withstand voltage	4kV					
SUPPLY/MEASUREMENT CONNECTION CIRCUIT						
Type of terminals	Fixed					
Conductor section (min...max)	1.5...10mm ² (16...6AWG)					
Maximum tightening torque	1.5Nm (14lb.in)					
CONNECTION (PULSE OUTPUT/RS485/MBUS)						
Type of terminals	Fixed					
Conductor section (min...max)	0.2...4mm ² (24...12AWG)					
Maximum tightening torque	0.8Nm (7lb.in)					
AMBIENT CONDITIONS						
Operating temperature	-25...+55°C					
Storage temperature	-25...+70°C					
Relative humidity	<80%					
Maximum pollution degree	2					
Mechanical environment	-	-	Class M1	-	-	
Magnetic environment	-	-	Class E1	-	-	
HOUSING						
Material	Polyamide					

25 Metering instruments and current transformers

Technical characteristics
Single-phase energy meters

DMED111/112	DMED110T1MID DMED111MID/MID7 DMED112MID	DMED115T1	DMED120T1	DMED120T1A120	DMED120T1MID DMED121MID DMED122MID	DMED121	DMED130LM DMED122
Single-phase	Single-phase	Single-phase	Single-phase	Single-phase	Single-phase	Single-phase	Single-phase
110...240VAC	230VAC	220...240VAC	220...240VAC	110...120VAC	230VAC	110...240VAC	220...240VAC
93...264VAC	187...264VAC	187...264VAC	187...264VAC	93...132VAC	187...264VAC	88...264VAC	187...264VAC
50/60Hz	50Hz	50/60Hz	50/60Hz	60Hz	50Hz	50/60Hz	
1VA	7VA	7VA			4.8VA		4.8VA
0.4W	0.45W	0.45W			1.4W		1.4W
40A		40A	63A			63A	
0.25A		0.5A			0.5A		0.5A
5A		10A			10A		10A
20mA		40mA			40mA		40mA
0.5A		1A			1A		1A
Class 1/B	Class B (EN 50470-3)	Class 1			Class B (EN 50470-3)	Class 1	
1000 flash/kWh		1000 flash/kWh			1000 flash/kWh		1000 flash/kWh
1000 pulses/kWh		1000 pulses/kWh			1000 pulses/kWh		1000 pulses/kWh
30ms		30ms			30ms		30ms
1-10-100-1000 pulses/kWh programmable (only for DMED...T1...)		1-10-100-1000 pulses/kWh programmable (only for DMED...T1...)			-		-
100ms		100ms			-		-
10...30VDC		10...30VDC			-		-
50mA		50mA			-		-
250VAC		250VAC			250VAC		250VAC
6kV		6kV			6kV		6kV
4kV		4kV			4kV		4kV
Fixed		Fixed			Fixed		Fixed
1.5...10mm ² (16...6AWG)		2.5...16mm ² (14...6AWG; 14...10AWG)			2.5...16mm ² (14...6AWG; 14...10AWG)		2.5...16mm ² (14...6AWG; 14...10AWG)
1.5Nm (14lb.in)		2Nm (26.5lb.in)			2Nm (26.5lb.in)		2Nm (26.5lb.in)
Fixed		Fixed			Fixed		Fixed
0.2...4mm ² (24...12AWG)		0.5...4mm ² (20...11AWG)			0.5...4mm ² (20...11AWG)		0.5...4mm ² (20...11AWG)
0.8Nm (7lb.in)		1.3Nm (12.1lb.in)			1.3Nm (12.1lb.in)		1.3Nm (12.1lb.in)
		-25...+55°C (MID7: -25...+70°C)					
-25...+70°C		-25...+70°C			-25...+70°C		-25...+70°C
<80%		<80%			<80%		<80%
2		2			2		2
Class M1		-	-	-	Class M1	-	-
Class E1		-	-	-	Class E1	-	-
Polyamide		Polyamide			Polyamide		Polyamide

25 Metering instruments and current transformers

Technical characteristics
Three-phase energy meters



INDEX

TYPE	DMED300T2... DMED301... DMED302	DMED300T2MID DMED301MID/MID7 DMED300MID	DMED310T2 DMED305T2	DMED310T2MID DMED305T2MID	DMED330 DMED332	DMED330MID DMED332MID
	3 phase with neutral	3 phase with neutral	3 phase with and without neutral	3 phase with neutral	3 phase with and without neutral	3 phase with neutral
AUXILIARY SUPPLY						
Rated voltage (Ue)	380...415VAC (3ph-N) DMED...UL: 120VAC (LN) - 240VAC (L-L)	400VAC (3ph-N)	380...415VAC (3ph-N)	400VAC (3ph-N)	380...415VAC (3ph-N)	400VAC (3ph-N)
Voltage range	187...264VAC phase-neutral / 323...456VAC phase-phase					
Rated frequency	50/60Hz (UL: 60Hz)	50Hz	50/60Hz	50Hz	50/60Hz	50Hz
Maximum power consumption	20VA		3.5VA		3.5VA	
Maximum power dissipation	1.35W		2.7W		2.7W	
CURRENT						
IEC maximum current (Imax)	80A		5A		5A	
IEC minimum current (Imin)	0.75A		0.05A		0.05A	
IEC rated current (Iref-Ib)	15A		5A		5A	
IEC start current (Ist)	60mA		0.005A		0.005A	
IEC transition current (Itr)	1.5A		0.25A		0.25A	
ACCURACY						
Active energy (per IEC/EN/BS 62053-21)	Class 1	Class B (EN50470-3)	Class 0.5s DMED305T2 Class 1 DMED310T2	Class B (EN50470-3)	Class 0.5s	Class B (EN50470-3)
TARIFF CIRCUIT INPUT						
Rated voltage (Uc)	100...240VAC					
Voltage range	85...264VAC					
Frequency	50/60Hz					
Maximum power consumption	0.25VA					
Maximum power dissipation	0.18W					
LED						
Pulse rate	1000 pulses/kWh					
Pulse duration	30ms					
STATIC OUTPUTS						
Pulse rate	1-10-100-1000 pulses/kWh programmable (except DMED301/302)		0.1-1-10-100 pulses/kWh programmable		—	
Pulse duration	100ms for 1-10-100 pulses (except DMED301/302) 60ms for 1000 pulses (except DMED301/302)		100ms		—	
External voltage	10...30VDC (except DMED301/302)		10...30VDC		—	
Maximum current	50mA (except DMED301/302)		—		—	
INSULATION						
IEC rated insulation voltage Ui	250VAC					
IEC rated impulse withstand voltage Uimp	6kV					
IEC power frequency withstand voltage	4kV					
SUPPLY/MEASUREMENT CIRCUIT CONNECTIONS						
Type of terminals	Fixed		Fixed			
Conductor section (min...max)	2.5...16mm ² (16...6AWG)		0.2...4mm ² (24...12AWG) for supply/voltage measurement; 0.2...2.5mm ² (24...12AWG) for current measurement			
Maximum tightening torque	2Nm (14lb.in)		0.8Nm (7lb.in)			
TARIFF CONTROL CIRCUIT CONNECTIONS						
Type of terminals	Fixed		Fixed			
Conductor section (min...max)	0.2...2.5mm ² (24...12AWG)		0.2...4mm ² (24...12AWG)			
Maximum tightening torque	0.49Nm (4.4lb.in)		0.8Nm (7lb.in) (0.44Nm / 4lb.in for current measurement DMED320)			
CONNECTIONS (PULSE OUTPUT/RS485)						
Type of terminals	Fixed		Fixed			
Conductor section (min...max)	0.2...1.3mm ² (24...16AWG)		0.2...2.5mm ² (24...12AWG)			
Maximum tightening torque	0.15Nm (1.7lb.in)		0.44Nm (4lb.in)			
AMBIENT CONDITIONS						
Operating temperature	-25...+55°C					
Storage temperature	-25...+70°C					
Relative humidity	<80% non condensing					
Maximum pollution degree	2		2		2	
Mechanical environment	— Class M1		— Class M1		— Class M1	
Magnetic environment	— Class E1		— Class E1		— Class E1	
HOUSING						
Material	Polyamide		Polyamide			

TYPE	DMECD
AUXILIARY SUPPLY	
Rated voltage (Us)	100...240VAC/110...250VDC
Voltage range	85...264VAC/93.5...300VDC
Rated frequency	50/60Hz
Maximum power consumption	8.8VA
Maximum power dissipation	3.6W
ENERGY METER INPUTS	
Number of inputs	8
Input separations	1 common for every 2 inputs (insulated between each pair 500VRMS)
Type of input	Negative (NPN)
Maximum voltage at inputs	15VDC
Maximum input current	18mA (15mA typical)
High input signal	≥7.6V
Low input signal	≤2V
Maximum frequency	2000Hz
TARIFF CONTROL CIRCUIT	
Rated voltage (Uc)	100...240VAC/110VDC
Voltage range	85...264VAC/93.5...140VDC
Frequency	50/60Hz
Maximum power consumption	0.25VA
Maximum power dissipation	0.18W
RS485 SERIAL INTERFACE	
Baud-rate	Programmable 1200...38400bps
Insulation	1500VAC towards energy meter inputs. Double insulation towards supply and tariff inputs
INSULATION	
IEC rated insulation voltage Ui	250VAC
IEC rated impulse withstand voltage Uimp	6.5kV
IEC power frequency withstand voltage	3.6kV
SUPPLY CIRCUIT CONNECTIONS	
Type of terminals	Fixed
Conductor section (min...max)	0.2...4mm ² (24...12AWG)
Maximum tightening torque	0.8Nm (7lb.in)
TARIFF INPUT CIRCUIT CONNECTIONS	
Type of terminals	Fixed
Conductor section (min...max)	0.2...4mm ² (24...12AWG)
Maximum tightening torque	0.8Nm (7lb.in)
RS485 CONNECTION	
Type of terminals	Fixed
Conductor section (min...max)	0.2...4mm ² (24...12AWG)
Maximum tightening torque	0.8Nm (7lb.in)
ENERGY METER INPUT CONNECTIONS	
Type of terminals	Fixed
Conductor section (min...max)	0.2...2.5mm ² (24...12AWG)
Maximum tightening torque	0.44Nm (4lb.in)
AMBIENT CONDITIONS	
Operating temperature	-20...+60°C
Storage temperature	-30...+80°C
Relative humidity	<90%
Maximum pollution degree	2
HOUSING	
Material	Polyamide

25 Metering instruments and current transformers

Technical characteristics
LCD multimeters and power analyzers



INDEX

TYPE	DMG100 - DMG110 ^①	DMG200	DMG210	DMG300
AUXILIARY SUPPLY				
Rated voltage Us	100...240VAC/ 110...250VDC			
Voltage range	85...264VAC/ 93.5...300VDC			
Frequency range	45...66Hz, 360...440Hz			
Maximum power consumption	3.5VA	3.5VA	4.5VA	3.2VA
Maximum power dissipation	1.2W	1.2W	1.7W	1.3W
Microbreaking immunity	≥50ms	≥50ms	≥50ms	≥50ms
VOLTAGE INPUTS				
Type of input	Three-phase + neutral			
Maximum rated voltage Ue	690VAC phase-phase (400VAC phase-neutral)			
Measurement range	20...830VAC phase-phase (10...480VAC phase-neutral)			
Frequency range	45...66Hz, 360...440Hz			
Method of measurement	True RMS			
Method of connection	Single, two, three-phase with or without neutral, balanced three-phase systems			
CURRENT INPUTS				
Rated current Ie	5A	5A	5A	1A/5A
Current reading through Rogowski coils	-			
Measurement range	0.01...6A	0.01...6A	0.01...6A	0.01...1.2A / 0.01...6A
Method of measurement	True RMS			
Overload capacity	+20% Ie through external CT with 5A secondary			
Overload peak	50A for 1s			
INSULATION				
IEC rated insulation voltage Ui	690VAC			
IEC rated impulse withstand voltage Uimp	9.5kV			
IEC power frequency withstand voltage	5.2kV			
SUPPLY CIRCUIT/VOLTAGE MEASUREMENT CONNECTIONS				
Type of terminal	Fixed			
Conductor section (min...max)	0.2...4.0mm ² (24...12 AWG)			
Maximum tightening torque	0.8Nm (7lb.in)			
CURRENT MEASUREMENT CIRCUIT AND RS485^①				
Type of terminal	Fixed			
Conductor section (min...max)	0.2...2.5mm ² (24...12AWG)			
Maximum tightening torque	0.44Nm (4lb.in)			
AMBIENT CONDITIONS				
Operating temperature	-20...+60°C			
Storage temperature	-30...+80°C			
Relative humidity	<90%			
Maximum pollution degree	2			
Measurement class	III			
HOUSING				
Material	Polyamide			

① RS485 communication port for DMG110, DMG210, DMG610 and DMG611 only.

② Consult Technical support about versions with supply 12...48VDC; see contact details on inside front cover.

	DMG6...	DMG7000	DMG7500	DMG8000	DMG9000
	100...440VAC 120...250VDC		100...240VAC 120...250VDC		
	90...484VAC 93.5...300VDC		90...264VAC 93.5...300VDC		
	45...66Hz, 360...440Hz		45...66Hz, 360...440Hz		
	9.5VA		15VA		
	3.5W		6W		
	≥50ms		≥50ms		
	Three-phase + neutral		Three-phase + neutral		
	600VAC phase-phase (300VAC phase-neutral)		600VAC phase-phase (300VAC phase-neutral)		
	50...720VAC phase-phase (30...360VAC phase-neutral)		50...720VAC phase-phase (30...360VAC phase-neutral)		
	45...66Hz, 360...440Hz		45...66Hz, 360...440Hz		
	True RMS		True RMS		
	Single, two, three-phase with or without neutral, balanced three-phase systems				
	1A/5A		1A/5A		
	20...6300A (for DMG611...)		-		
	0.01...1.2A / 0.01...6A		0.005...1.2A / 0.005...6A		
	True RMS		True RMS		
	+20% Ie by external CT with 5A secondary 50A for 1s				
	600VAC		600VAC		
	9.5kV		9.5kV		
	5.2kV		5.2kV		
			Removable		
			0.2...2.5mm ² (24...12AWG)		
			0.5Nm (4.5lb.in)		
	Fixed		Removable		
	0.2...1.5mm ² (24...12AWG)		0.2...2.5mm ² (24...12AWG)		
	0.8Nm (7lb.in)		0.5Nm (4.5lb.in)		
			-20...+60°C		
			-30...+80°C		
			<90%		
			2		
			III		
			Polyamide		

TYPE		DMK10R1 DMK70R1	DMK11R1 DMK71R1	DMK15R1 DMK75R1	DMK16R1
AUXILIARY SUPPLY					
Rated voltage Us		220...240VAC			
Operating voltage range		0.85...1.1 Us			
Rated frequency		50...60Hz ±10%			
Maximum power consumption		3.6VA	3.6VA	3.6VA	3.9VA
Maximum power dissipation		1.8W	1.8W	1.8W	2.1W
VOLTAGE INPUTS					
Rated voltage Ue	phase-phase	600VAC	—	600VAC	600VAC
	phase-neutral	347VAC	—	347VAC	347VAC
Operating voltage range	phase-phase	15...660VAC	—	35...660VAC	35...660VAC
	phase-neutral	10...382VAC	—	20...382VAC	20...382VAC
Rated frequency		50...60Hz ±10%	—	50...60Hz ±10%	50...60Hz ±10%
Method of measuring		True RMS	—	True RMS	True RMS
CURRENT INPUTS					
Rated current Ie		—	5A	5A	5A
Measuring range		—	0.05...6A	0.05...5.75A	0.05...5.75A
Rated frequency		—	50...60Hz ±10%	50...60Hz ±10%	50...60Hz ±10%
Type of input		—	Shunts connected by external low voltage CT 5A max		
Type of measuring		—	True RMS	True RMS	True RMS
Overload capacity		—	+20% Ie	+20% Ie	+20% Ie
MEASURING ACCURACY					
Measurement conditions (Temperature +23°C ±1°C) (Relative humidity 45 ±15% R.H.)	voltage	±0.25% f.s. ±1 digit	—	±0.25% f.s. ±1 digit	±0.25% f.s. ±1 digit
	current	—	±0.5% f.s. ±1 digit	±0.5% f.s. ±1 digit	±0.5% f.s. ±1 digit
	power	—	—	1% f.s. ±1 digit	1% f.s. ±1 digit
	energy	—	—	—	Class 2
	frequency	—	—	—	±1 digit
RELAY OUTPUT					
Number and type of contact		1 changeover	1 changeover	1 changeover ^①	1 changeover
Rated voltage		250VAC	250VAC	250VAC	250VAC
IEC/EN/BS 60947-5-1 designation		AC1 8A 250VAC / B300	AC1 8A 250VAC / B300	AC1 8A 250VAC / B300	AC1 8A 250VAC / B300
Electrical life (ops.)		10 ⁵	10 ⁵	10 ⁵	10 ⁵
Mechanical life (ops.)		30x10 ⁶	30x10 ⁶	30x10 ⁶	30x10 ⁶
INSULATION					
Rated insulation voltage Ui		600VAC	415VAC	600VAC	600VAC
CONNECTIONS					
Type of terminals		Removable (DMK1...); fixed (DMK7...)			
Maximum tightening torque		0.5Nm (4.5lb.in) for DMK1...; 0.8Nm (7lb.in) for DMK7...			
Conductor section (min...max)		0.2...2.5mm ² (24...12AWG) for DMK0... 0.2...4.0mm ² (24...12AWG) for DMK7...			
AMBIENT CONDITIONS					
Operating temperature		-20...+60°C	-20...+60°C	-20...+60°C	-20...+60°C
Storage temperature		-30...+80°C	-30...+80°C	-30...+80°C	-30...+80°C
HOUSING					
Material		Thermoplastic (DMK1...)/ Polyamide (DMK7...)			

① One contact NO for DMK75R1.

TYPE		DMK00R1 DMK80R1	DMK01R1 DMK81R1	DMK02
AUXILIARY SUPPLY				
Rated voltage Us			220...240VAC	
Operating voltage range			0.85...1.1 Us	
Rated frequency			50...60Hz ±10%	
Maximum power consumption			3.6VA	
Maximum power dissipation			1.8W	
VOLTAGE INPUTS				
Rated voltage Ue		600VAC	—	600VAC
Operating voltage range		15...660VAC	—	15...660VAC
Operating voltage range, phase-phase		—	—	—
Rated frequency		50...60Hz ±10%	—	50...60Hz ±10%
Method of measuring		True RMS	—	True RMS
CURRENT INPUTS				
Rated current Ie		—	5A	5A
Measuring range		—	0.05...5.75A	0.05...5.75A
Rated frequency		—	50...60Hz ±10%	50...60Hz ±10%
Type of input		—	Shunts connected by external low voltage CT 5A max	
Type of measuring		—	True RMS	True RMS
Overload capacity		—	+20% Ie	+20% Ie
MEASURING ACCURACY				
Measurement conditions (Temperature +23°C ±1°C) (Relative humidity 45 ±15% R.H.)	cosφ	—	—	—
	voltage	±0.25% f.s. ±1 digit	—	±0.25% f.s. ±1 digit
	current	—	±0.5% f.s. ±1 digit	±0.5% f.s. ±1 digit
	frequency	—	—	—
ADDITIONAL ERRORS				
Relative humidity			±1 digit 60%...90% R.H.	
Temperature			±1 digit -20...+60°C	
RELAY OUTPUT FOR DMK... R1 TYPES ONLY				
Number and type of contact			1 changeover	
Rated voltage			250VAC	
IEC/EN/BS 60947-5-1 designation			AC1 8A 250VAC / B300	
Electrical life (ops.)			10 ⁵	
Mechanical life (ops.)			30x10 ⁶	
INSULATION				
Rated insulation voltage Ui		600VAC	415VAC	600VAC
CONNECTIONS				
Type of terminals			Fixed (DMK...); Removable (DMK0...)	
Maximum tightening torque			0.8Nm (7lb.in) for DMK0... / 0.5Nm (4.5lb.in) for DMK8...	
Conductor section (min...max)			0.2...2.5mm ² (24...12AWG) for DMK0... 0.2...4.0mm ² (24...12AWG) for DMK8...	
AMBIENT CONDITIONS				
Operating temperature			-20...+60°C	
Storage temperature			-30...+80°C	
HOUSING				
Material			Thermoplastic (DMK0...) / Polyamide (DMK8...)	