



- Dimensions compatible to EN/BS 50047
- Direct opening action of NC contacts
- Extensive range of operating heads
- Versions complete with interchangeable and rotatable heads
- Versions with removable and interchangeable auxiliary contact blocks.

	SEC. - PAGE
Metal and plastic limit switches, K series (dimensions to/compatible to EN/BS 50047)	
Top push rod plunger	10 - 2
Top roller push plunger	10 - 3
Roller centre push lever	10 - 4
Roller side push lever	10 - 5
Roller lever plunger	10 - 6
Adjustable roller lever	10 - 8
Ceramic rod lever	10 - 10
Adjustable rod lever	10 - 11
Wobble stick, omnidirectional	10 - 12
Accessories and spare parts	10 - 13
Prewired metal limit switches	10 - 15
Metal limit switches, PL series	
Top push rod plunger, top roller push plunger, roller centre push lever	10 - 16
Latch and manual release.....	10 - 17
Manual reload and magnetic release	10 - 17
Bi-directional	10 - 17
Rope-pull lever limit switches for normal stopping	10 - 18
Plastic micro switches	10 - 20
Foot switches	10 - 21
Dimensions	10 - 22
Wiring diagrams	10 - 27



Page 10-2

PLASTIC AND METAL LIMIT SWITCHES K SERIES

- Dimensions to EN/BS 50047 standards for KB and KM types
- Dimensions compatible to EN/BS 50047 for KC and KN types
- Self-extinguishing polymer thermoplastic housing (KB-KC types)
- Aluminium-zinc alloy housing (KM-KN types)
- Removable and interchangeable auxiliary contact blocks
- Bi-directional versions
- Unique fixing mechanism of operating head
- IEC degree of protection IP65
- M20 cable entry; PG13.5 or 1/2 NPT entry available.



Page 10-15

PREWIRED METAL LIMIT SWITCHES

- Dimensions to EN/BS 50047 standards
- 2 meter long cable
- IEC degree of protection IP67.

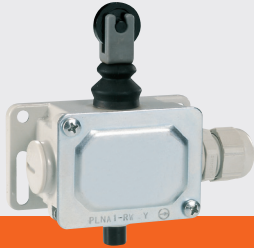

Page 10-16

METAL LIMIT SWITCHES PL SERIES

- Aluminium-zinc alloy housing
- Maximum of 2 auxiliary contacts
- IEC degree of protection IP40 and IP65
- PG11 cable entry.



Page 10-18

ROPE-PULL LEVER LIMIT SWITCHES FOR NORMAL STOPPING

- Self-extinguishing polymer thermoplastic housing
- Aluminium-zinc alloy housing
- IEC degree of protection IP40, IP65
- PG11 cable entry.



Page 10-20

PLASTIC MICRO SWITCHES

- Polymer thermoplastic housing
- Changeover contact switch
- IEC degree of protection IP00 or IP20.



Page 10-21

FOOT SWITCHES

- Versions with or without protection cover
- Self-extinguishing polymer thermoplastic housing
- Aluminium-zinc alloy housing
- IEC degree of protection IP20, IP54 and IP65
- M20 cable entry.

10 Limit, micro and foot switches

Limit switches, K series. One bottom cable entry. Dimensions to EN/BS 50047
Two side cable entries. Dimensions compatible to EN/BS 50047



INDEX

Top push rod plunger



KBA... - KMA...



KCA... - KNA...

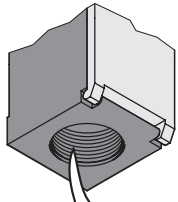

M20 CABLE ENTRY

For types with PG13.5 cable entry, add the letter P at the end of the order code while for 1/2 NPT, add N. E.g. KBA1S11P - KBA1S11N

Order code	Plastic body	Metal body	Contacts	Plunger material	Qty per pkg	Wt
					n°	[kg]

One bottom cable entry. Dimensions to EN/BS 50047.

KBA1S11	KMA1S11	1NO+1NC Snap action Ⓢ	Metal	5	Ⓢ
KBA1S02	KMA1S02	2NC Snap action Ⓢ	Metal	5	Ⓢ
KBA1A11	KMA1A11	1NO+1NC Slow action make before break Ⓢ	Metal	5	Ⓢ
KBA1L11	KMA1L11	1NO+1NC Slow action Ⓢ	Metal	5	Ⓢ
KBA1L02	KMA1L02	2NC Slow action Ⓢ	Metal	5	Ⓢ
KBA1L20	KMA1L20	2NO Slow action	Metal	5	Ⓢ
KBA1L12	KMA1L12	1NO+2NC Slow action Ⓢ	Metal	5	Ⓢ
KBA1L21	KMA1L21	2NO+1NC Slow action Ⓢ	Metal	5	Ⓢ
KBA1L03	KMA1L03	3NC Slow action Ⓢ	Metal	5	Ⓢ

Two side cable entries. Dimensions compatible to EN/BS 50047.

KCA1S11	KNA1S11	1NO+1NC Snap action Ⓢ	Metal	5	Ⓢ
KCA1S02	KNA1S02	2NC Snap action Ⓢ	Metal	5	Ⓢ
KCA1A11	KNA1A11	1NO+1NC Slow action make before break Ⓢ	Metal	5	Ⓢ
KCA1L11	KNA1L11	1NO+1NC Slow action Ⓢ	Metal	5	Ⓢ
KCA1L02	KNA1L02	2NC Slow action Ⓢ	Metal	5	Ⓢ
KCA1L20	KNA1L20	2NO Slow action	Metal	5	Ⓢ

Ⓢ Direct (positive) opening action Ⓢ safety function according to IEC/EN/BS 60947-5-1.

Ⓢ Consult Technical support for information; see contact details on inside cover.

General characteristics

The LOVATO Electric limit switches have been designed to satisfy requirements comprising quick installation, easy wiring, simple setup, modularity, sturdiness and constant reliability.

The body cover is hinged at the bottom and removable. The innovative locking bayonet mechanism permits to remove and reposition the operating head in the required configuration with no tools. The auxiliary contact blocks are removable assuring remarkable wiring ease.

Operational characteristics

- Maximum operating rate: 3600 cycles/h
- Switching speed: 0.5...1.5m/s
- Mechanical life: >10 million cycles
- IEC conventional thermal current Ith: 10A
- UL/CSA and IEC/EN/BS 60947-5-1 designation:
 - A600 Q300 for KB...-KC... types
 - A300 Q300 for KM...-KN... types
- IEC rated insulation voltage Ui:
 - 690VAC for KB...-KC... types
 - 440VAC for KM...-KN... types
- IEC rated impulse withstand voltage Uimp:
 - 6kV for KB...-KC... types
 - 4kV for KM...-KN... types
- Class II insulation for KB...-KC... only
- Contact resistance: <10mΩ
- Short-circuit backup protection: 10A gG/SC quick fuse
- Operators of aluminium-zinc alloy
- Housing:
 - KB...-KC... types: self-extinguishing double-insulation polymer thermoplastic
 - KM...-KN... types: aluminium-zinc alloy
- Cable entry: M20 standard supplied; PG13.5 and 1/2 NPT available (see the side note for details)
- Operating head fixing: locking bayonet insert
- Operating force: 5N / 1.1lb
- Cable connection: self-releasing screw terminal
- Tightening torque:
 - Switch fixing: 2.5Nm / 22.1lb.in
 - Contact terminals: 0.8Nm / 7lb.in
 - Body lid screw fixing: 0.8Nm / 7lb.in
- Conductor section: 1 or 2 2.5mm² max / 16-14AWG
- Ambient conditions:
 - Operating temperature: -25...+70°C
 - Storage temperature: -40...+70°C
 - Pollution degree: 3
 - IEC degree of protection: IP20 for terminals
 - IEC degree of protection: IP65 for body housing.

Certifications and compliance

Certifications obtained: UL Listed for USA and Canada (cULus - File E93601), as Auxiliary Devices - Limit switches; EAC, CCC.

Compliant with standards: EN/BS 50047, IEC/EN/BS 60947-1, IEC/EN/BS 60947-5-1, IEC/EN/BS 60204-1, UL508, CSA C22.2 n° 14.

- ▶ Forward travel of snap action contacts
- ◀ Return travel of snap action contacts
- open
- closed

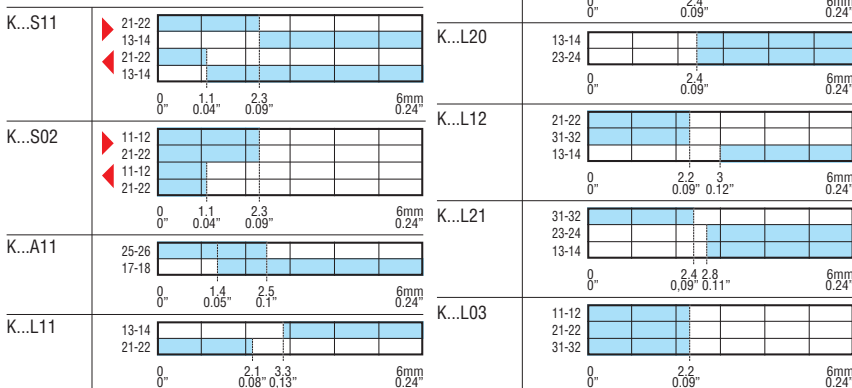

10 Limit, micro and foot switches

Limit switches, K series. One bottom cable entry. Dimensions to EN/BS 50047
Two side cable entries. Dimensions compatible to EN/BS 50047

Top roller push plunger



KBB... - KMB...

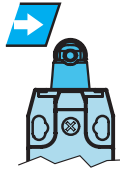

KCB... - KNB...

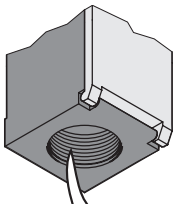

M20 CABLE ENTRY

For types with PG13.5 cable entry, add the letter P at the end of the order code while for 1/2 NPT, add N. E.g. KBB1S11P - KBB1S11N

Order code	Plastic body	Metal body	Contacts	Roller material	Qty per pkg	Wt [kg]
				Ø11x4	n°	[kg]

One bottom cable entry. Dimensions to EN/BS 50047.

KBB1S11	KMB1S11	1NO+1NC	Plastic	5	⊕
KBB2S11	KMB2S11	Snap action ⊕	Metal	5	⊕
KBB1S02	KMB1S02	2NC	Plastic	5	⊕
KBB2S02	KMB2S02	Snap action ⊕	Metal	5	⊕
KBB1A11	KMB1A11	1NO+1NC	Plastic	5	⊕
KBB2A11	KMB2A11	Slow action make before break ⊕	Metal	5	⊕
KBB1L11	KMB1L11	1NO+1NC	Plastic	5	⊕
KBB2L11	KMB2L11		Metal	5	⊕
KBB1L02	KMB1L02	2NC	Plastic	5	⊕
KBB2L02	KMB2L02	Slow action ⊕	Metal	5	⊕
KBB1L20	KMB1L20	2NO	Plastic	5	⊕
KBB2L20	KMB2L20	Slow action ⊕	Metal	5	⊕
KBB1L12	KMB1L12	1NO+2NC	Plastic	5	⊕
KBB2L12	KMB2L12	Slow action	Metal	5	⊕
KBB1L21	KMB1L21	2NO+1NC	Plastic	5	⊕
KBB2L21	KMB2L21	Slow action ⊕	Metal	5	⊕
KBB1L03	KMB1L03	3NC	Plastic	5	⊕
KBB2L03	KMB2L03	Slow action ⊕	Metal	5	⊕

Two side cable entries. Dimensions compatible to EN/BS 50047.

KCB1S11	KNB1S11	1NO+1NC	Plastic	5	⊕
KCB2S11	KNB2S11	Slow action ⊕	Metal	5	⊕
KCB1S02	KNB1S02	2NC	Plastic	5	⊕
KCB2S02	KNB2S02	Slow action ⊕	Metal	5	⊕
KCB1A11	KNB1A11	1NO+1NC	Plastic	5	⊕
KCB2A11	KNB2A11	Slow action make before break ⊕	Metal	5	⊕
KCB1L11	KNB1L11	1NO+1NC	Plastic	5	⊕
KCB2L11	KNB2L11	Slow action ⊕	Metal	5	⊕
KCB1L02	KNB1L02	2NC	Plastic	5	⊕
KCB2L02	KNB2L02	Slow action ⊕	Metal	5	⊕
KCB1L20	KNB1L20	2NO	Plastic	5	⊕
KCB2L20	KNB2L20	Slow action	Metal	5	⊕

⊕ Direct (positive) opening action ⊖ safety function according to IEC/EN/BS 60947-5-1.
⊕ Consult Technical support for information; see contact details on inside cover.

Ø11x4mm = Ø0.43x0.16"

General characteristics

The LOVATO Electric limit switches have been designed to satisfy requirements comprising quick installation, easy wiring, simple setup, modularity, sturdiness and constant reliability.

The body cover is hinged at the bottom and removable. The innovative locking bayonet mechanism permits to remove and reposition the operating head in the required configuration with no tools. The heads have axial rotation of 45° angles.

The auxiliary contact blocks are removable assuring remarkable wiring ease.

Operational characteristics

- Maximum operating rate: 3600 cycles/h
- Switching speed: 0.5...1.5m/s
- Mechanical life: >10 million cycles
- IEC conventional thermal current Ith: 10A
- UL/CSA and IEC/EN/BS 60947-5-1 designation:
 - A600 Q300 for KB...-KC... types
 - A300 Q300 for KM...-KN... types
- IEC rated insulation voltage Ui:
 - 690VAC for KB...-KC... types
 - 440VAC for KM...-KN... types
- IEC rated impulse withstand voltage Uimp:
 - 6kV for KB...-KC... types
 - 4kV for KM...-KN... types
- Class II insulation for KB...-KC... only
- Contact resistance: <10mΩ
- Short-circuit backup protection: 10A gG/SC quick fuse
- Operators of aluminium-zinc alloy
- Housing:
 - KB...-KC... types: self-extinguishing double-insulation polymer thermoplastic
 - KM...-KN... types: aluminium-zinc alloy
- Cable entry: M20 standard supplied; PG13.5 and 1/2 NPT available (see the side note for details)
- Operating head fixing: locking bayonet insert
- Operating force: 5N / 1.1lb
- Cable connection: self-releasing screw terminal
- Tightening torque:
 - Switch fixing: 2.5Nm / 22.1lb.in
 - Contact terminals: 0.8Nm / 7lb.in
 - Body lid screw fixing: 0.8Nm / 7lb.in
- Conductor section: 1 or 2 2.5mm² max / 16-14AWG
- Ambient conditions:
 - Operating temperature: -25...+70°C
 - Storage temperature: -40...+70°C
 - Pollution degree: 3
 - IEC degree of protection: IP20 for terminals
 - IEC degree of protection: IP65 for body housing.

Certifications and compliance

Certifications obtained: UL Listed for USA and Canada (cULus - File E93601), as Auxiliary Devices - Limit switches; EAC, CCC.

Compliant with standards: EN/BS 50047, IEC/EN/BS 60947-1, IEC/EN/BS 60947-5-1, IEC/EN/BS 60204-1, UL508, CSA C22.2 n° 14.

- ▶ Forward travel of snap action contacts
- ◀ Return travel of snap action contacts

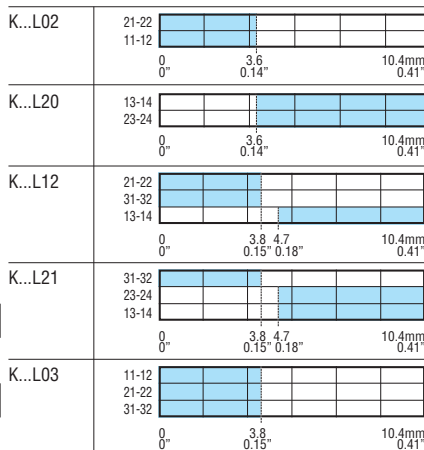
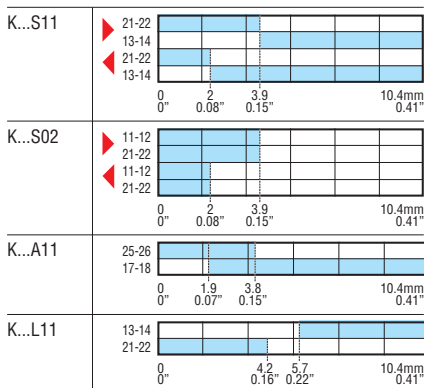

10 Limit, micro and foot switches

Limit switches, K series. One bottom cable entry. Dimensions to EN/BS 50047
Two side cable entries. Dimensions compatible to EN/BS 50047

INDEX

Roller centre push lever



KBC... - KMC...

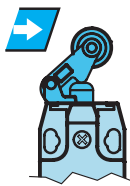

KCC... - KNC...

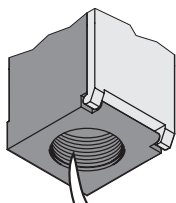

M20 CABLE ENTRY

For types with PG13.5 cable entry, add the letter P at the end of the order code while for 1/2 NPT, add N. E.g. KBC1S11P - KBC1S11N

Order code	Plastic body	Metal body	Contacts	Roller material	Qty per pkg	Wt [kg]
				Ø14x5	n°	[kg]

One bottom cable entry. Dimensions to EN/BS 50047.

KBC1S11	KMC1S11	1NO+1NC	Plastic	5	⊕
KBC2S11	KMC2S11	Snap action ①	Metal	5	⊕
KBC1S02	KMC1S02	2NC	Plastic	5	⊕
KBC2S02	KMC2S02	Snap action ①	Metal	5	⊕
KBC1A11	KMC1A11	1NO+1NC	Plastic	5	⊕
KBC2A11	KMC2A11	Slow action make before break ①	Metal	5	⊕
KBC1L11	KMC1L11	1NO+1NC	Plastic	5	⊕
KBC2L11	KMC2L11	Snap action ①	Metal	5	⊕
KBC1L02	KMC1L02	2NC	Plastic	5	⊕
KBC2L02	KMC2L02	Snap action ①	Metal	5	⊕
KBC1L20	KMC1L20	2NO	Plastic	5	⊕
KBC2L20	KMC2L20	Snap action	Metal	5	⊕
KBC1L12	KMC1L12	1NO+2NC	Plastic	5	⊕
KBC2L12	KMC2L12	Snap action ①	Metal	5	⊕
KBC1L21	KMC1L21	2NO+1NC	Plastic	5	⊕
KBC2L21	KMC2L21	Snap action ①	Metal	5	⊕
KBC1L03	KMC1L03	3NC	Plastic	5	⊕
KBC2L03	KMC2L03	Snap action ①	Metal	5	⊕

Two side cable entries. Dimensions compatible to EN/BS 50047.

KCC1S11	KNC1S11	1NO+1NC	Plastic	5	⊕
KCC2S11	KNC2S11	Snap action ①	Metal	5	⊕
KCC1S02	KNC1S02	2NC	Plastic	5	⊕
KCC2S02	KNC2S02	Snap action ①	Metal	5	⊕
KCC1A11	KNC1A11	1NO+1NC	Plastic	5	⊕
KCC2A11	KNC2A11	Slow action make before break ①	Metal	5	⊕
KCC1L11	KNC1L11	1NO+1NC	Plastic	5	⊕
KCC2L11	KNC2L11	Snap action ①	Metal	5	⊕
KCC1L02	KNC1L02	2NC	Plastic	5	⊕
KCC2L02	KNC2L02	Snap action ①	Metal	5	⊕
KCC1L20	KNC1L20	2NO	Plastic	5	⊕
KCC2L20	KNC2L20	Snap action	Metal	5	⊕

① Direct (positive) opening action ⊕ safety function according to IEC/EN/BS 60947-5-1.

⊕ Consult Technical support for information; see contact details on inside cover.

Ø14x5mm = Ø0.55x0.2".

General characteristics

The LOVATO Electric limit switches have been designed to satisfy requirements comprising quick installation, easy wiring, simple setup, modularity, sturdiness and constant reliability.

The body cover is hinged at the bottom and removable.

The innovative locking bayonet mechanism permits to remove and reposition the operating head in the required configuration with no tools. The heads have axial rotation of 45° angles.

The auxiliary contact blocks are removable assuring remarkable wiring ease.

Operational characteristics

- Maximum operating rate: 3600 cycles/h
- Switching speed: 0.5...1.5m/s
- Mechanical life: >10 million cycles
- IEC conventional thermal current Ith: 10A
- UL/CSA and IEC/EN/BS 60947-5-1 designation:
 - A600 Q300 for KB...-KC... types
 - A300 Q300 for KM...-KN... types
- IEC rated insulation voltage Ui:
 - 690VAC for KB...-KC... types
 - 440VAC for KM...-KN... types
- IEC rated impulse withstand voltage Uimp:
 - 6kV for KB...-KC... types
 - 4kV for KM...-KN... types
- Class II insulation for KB...-KC... only
- Contact resistance: <10mΩ
- Short-circuit backup protection: 10A gG/SC quick fuse
- Operators of aluminium-zinc alloy
- Housing:
 - KB...-KC... types: self-extinguishing double-insulation polymer thermoplastic
 - KM...-KN... types: aluminium-zinc alloy
- Cable entry: M20 standard supplied; PG13.5 and 1/2 NPT available (see the side note for details)
- Operating head fixing: locking bayonet insert
- Operating force: 6N / 1.34lb
- Cable connection: self-releasing screw terminal
- Tightening torque:
 - Switch fixing: 2.5Nm / 22.1lb.in
 - Contact terminals: 0.8Nm / 7lb.in
 - Body lid screw fixing: 0.8Nm / 7lb.in
- Conductor section: 1 or 2 2.5mm² max / 16-14AWG
- Ambient conditions:
 - Operating temperature: -25...+70°C
 - Storage temperature: -40...+70°C
 - Pollution degree: 3
 - IEC degree of protection: IP20 for terminals
 - IEC degree of protection: IP65 for body housing.

Certifications and compliance

Certifications obtained: UL Listed for USA and Canada (cULus - File E93601), as Auxiliary Devices - Limit switches; EAC, CCC.

Compliant with standards: EN/BS 50047, IEC/EN/BS 60947-1, IEC/EN/BS 60947-5-1, IEC/EN/BS 60204-1, UL508, CSA C22.2 n° 14.

- ▶ Forward travel of snap action contacts
- ◀ Return travel of snap action contacts

□ open
■ closed

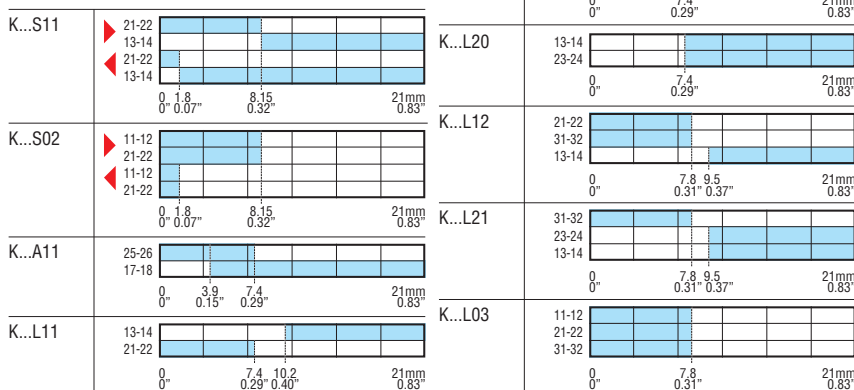

10 Limit, micro and foot switches

Limit switches, K series. One bottom cable entry. Dimensions to EN/BS 50047
Two side cable entries. Dimensions compatible to EN/BS 50047

Roller side push lever

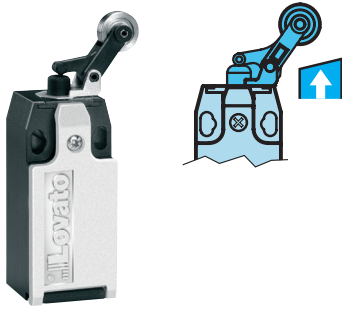

KBD... - KMD...



KCD... - KND...

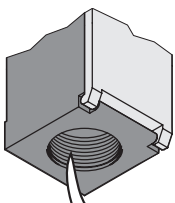

M20 CABLE ENTRY

For types with PG13.5 cable entry, add the letter P at the end of the order code while for 1/2 NPT, add N. E.g. KBD1S11P - KBD1S11N

Order code Plastic body	Order code Metal body	Contacts	Roller material	Qty per pkg	Wt [kg]
			Ø14x5	n°	

One bottom cable entry. Dimensions to EN/BS 50047.

KBD1S11	KMD1S11	1NO+1NC	Plastic	5	⊕
KBD2S11	KMD2S11	Snap action ⊕	Metal	5	⊕
KBD1S02	KMD1S02	2NC	Plastic	5	⊕
KBD2S02	KMD2S02	Snap action ⊕	Metal	5	⊕
KBD1A11	KMD1A11	1NO+1NC	Plastic	5	⊕
KBD2A11	KMD2A11	Slow action make before break ⊕	Metal	5	⊕
KBD1L11	KMD1L11	1NO+1NC	Plastic	5	⊕
KBD2L11	KMD2L11	Snap action ⊕	Metal	5	⊕
KBD1L02	KMD1L02	2NC	Plastic	5	⊕
KBD2L02	KMD2L02	Snap action ⊕	Metal	5	⊕
KBD1L20	KMD1L20	2NO	Plastic	5	⊕
KBD2L20	KMD2L20	Snap action	Metal	5	⊕
KBD1L12	KMD1L12	1NO+2NC	Plastic	5	⊕
KBD2L12	KMD2L12	Snap action ⊕	Metal	5	⊕
KBD1L21	KMD1L21	2NO+1NC	Plastic	5	⊕
KBD2L21	KMD2L21	Snap action ⊕	Metal	5	⊕
KBD1L03	KMD1L03	3NC	Plastic	5	⊕
KBD2L03	KMD2L03	Snap action ⊕	Metal	5	⊕

Two side cable entries. Dimensions compatible to EN/BS 50047.

KCD1S11	KND1S11	1NO+1NC	Plastic	5	⊕
KCD2S11	KND2S11	Snap action ⊕	Metal	5	⊕
KCD1S02	KND1S02	2NC	Plastic	5	⊕
KCD2S02	KND2S02	Snap action ⊕	Metal	5	⊕
KCD1A11	KND1A11	1NO+1NC	Plastic	5	⊕
KCD2A11	KND2A11	Slow action make before break ⊕	Metal	5	⊕
KCD1L11	KND1L11	1NO+1NC	Plastic	5	⊕
KCD2L11	KND2L11	Snap action ⊕	Metal	5	⊕
KCD1L02	KND1L02	2NC	Plastic	5	⊕
KCD2L02	KND2L02	Snap action ⊕	Metal	5	⊕
KCD1L20	KND1L20	2NO	Plastic	5	⊕
KCD2L20	KND2L20	Snap action	Metal	5	⊕

⊕ Direct (positive) opening action ⊖ safety function according to IEC/EN/BS 60947-5-1.
⊕ Consult Technical support for information; see contact details on inside cover.

Ø14x5mm = Ø0.55x0.2".

General characteristics

The LOVATO Electric limit switches have been designed to satisfy requirements comprising quick installation, easy wiring, simple setup, modularity, sturdiness and constant reliability.

The body cover is hinged at the bottom and removable. The innovative locking bayonet mechanism permits to remove and reposition the operating head in the required configuration with no tools. The heads have axial rotation of 45° angles.

The auxiliary contact blocks are removable assuring remarkable wiring ease.

Operational characteristics

- Maximum operating rate: 3600 cycles/h
- Switching speed: 0.5...1.5m/s
- Mechanical life: >10 million cycles
- IEC conventional thermal current Ith: 10A
- UL/CSA and IEC/EN/BS 60947-5-1 designation:
 - A600 Q300 for KB...-KC... types
 - A300 Q300 for KM...-KN... types
- IEC rated insulation voltage Ui:
 - 690VAC for KB...-KC... types
 - 440VAC for KM...-KN... types
- IEC rated impulse withstand voltage Uimp:
 - 6kV for KB...-KC... types
 - 4kV for KM...-KN... types
- Class II insulation for KB...-KC... only
- Contact resistance: <10mΩ
- Short-circuit backup protection: 10A gG/SC quick fuse
- Operators of aluminium-zinc alloy
- Housing:
 - KB...-KC... types: self-extinguishing double-insulation polymer thermoplastic
 - KM...-KN... types: aluminium-zinc alloy
- Cable entry: M20 standard supplied; PG13.5 and 1/2 NPT available (see the side note for details)
- Operating head fixing: locking bayonet insert
- Operating force: 6N / 1.34lb
- Cable connection: self-releasing screw terminal
- Tightening torque:
 - Switch fixing: 2.5Nm / 22.1lb.in
 - Contact terminals: 0.8Nm / 7lb.in
 - Body lid screw fixing: 0.8Nm / 7lb.in
- Conductor section: 1 or 2 2.5mm² max / 16-14AWG
- Ambient conditions:
 - Operating temperature: -25...+70°C
 - Storage temperature: -40...+70°C
 - Pollution degree: 3
 - IEC degree of protection: IP20 for terminals
 - IEC degree of protection: IP65 for body housing.

Certifications and compliance

Certifications obtained: UL Listed for USA and Canada (cULus - File E93601), as Auxiliary Devices - Limit switches; EAC, CCC.

Compliant with standards: EN/BS 50047, IEC/EN/BS 60947-1, IEC/EN/BS 60947-5-1, IEC/EN/BS 60204-1, UL508, CSA C22.2 n° 14.

- ▶ Forward travel of snap action contacts
- ◀ Return travel of snap action contacts

□ open
■ closed

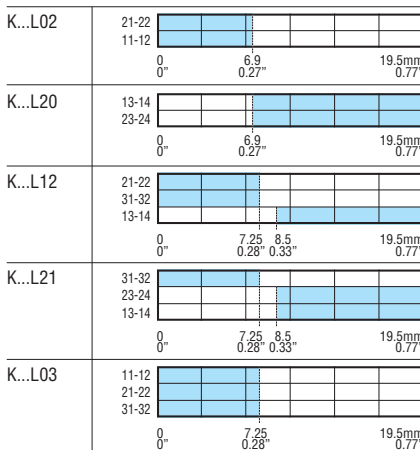
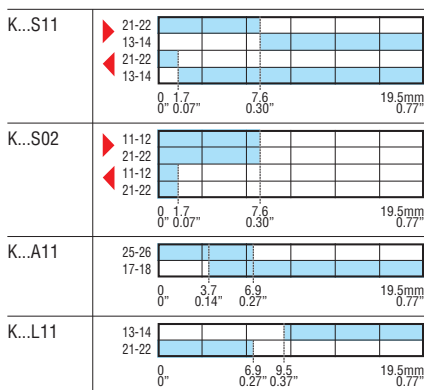

10 Limit, micro and foot switches

Limit switches, K series.

One bottom cable entry. Dimensions to EN/BS 50047



INDEX

Roller lever plunger



KBE1... - KBE2...
KME1... - KME2...

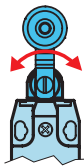

KBE3... - KME3...

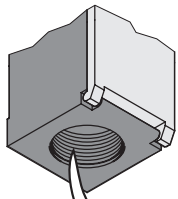

M20 CABLE ENTRY

For types with PG13.5 cable entry, add the letter P at the end of the order code while for 1/2 NPT, add N. E.g. KBE1S11P - KBE1S11N

Order code Plastic body	Order code Metal body	Contacts	Roller material	Qty per pkg	Wt [kg]
One bottom cable entry. Dimensions to EN/BS 50047.					
KBE1S11	KME1S11	1NO+1NC	Plastic①	5	④
KBE2S11	KME2S11	Slow action③	Metal①	5	④
KBE3S11	KME3S11		Rubber②	5	④
KBE1S02	KME1S02	2NC	Plastic①	5	④
KBE2S02	KME2S02	Slow action③	Metal①	5	④
KBE3S02	KME3S02		Rubber②	5	④
KBE1A11	KME1A11	1NO+1NC	Plastic①	5	④
KBE2A11	KME2A11	Slow action make before break①	Metal①	5	④
KBE3A11	KME3A11		Rubber②	5	④
KBE1L11	KME1L11	1NO+1NC	Plastic①	5	④
KBE2L11	KME2L11	Slow action③	Metal①	5	④
KBE3L11	KME3L11		Rubber②	5	④
KBE1L02	KME1L02	2NC	Plastic①	5	④
KBE2L02	KME2L02	Slow action③	Metal①	5	④
KBE3L02	KME3L02		Rubber②	5	④
KBE1L20	KME1L20	2NO	Plastic①	5	④
KBE2L20	KME2L20	Slow action	Metal①	5	④
KBE3L20	KME3L20		Rubber②	5	④
KBE1L12	KME1L12	1NO+2NC	Plastic①	5	④
KBE2L12	KME2L12	Slow action③	Metal①	5	④
KBE3L12	KME3L12		Rubber②	5	④
KBE1L21	KME1L21	2NO+1NC	Plastic①	5	④
KBE2L21	KME2L21	Slow action③	Metal①	5	④
KBE3L21	KME3L21		Rubber②	5	④
KBE1L03	KME1L03	3NC	Plastic①	5	④
KBE2L03	KME2L03	Slow action③	Metal①	5	④
KBE3L03	KME3L03		Rubber②	5	④

BI-DIRECTIONAL.

One bottom cable entry. Dimensions to EN/BS 50047.

Order code Plastic body	Order code Metal body	Contacts	Roller material	Qty per pkg	Wt [kg]
KBE1D02	KME1D02	2NC③ independent	Plastic①	5	④

① Ø19x5mm = Ø0.75x0.2"

② Ø50x10mm = Ø1.97"x0.39"

③ Direct (positive) opening action ⊕; safety function according to IEC/EN/BS 60947-5-1.

④ Consult Technical support for information; see contact details on inside cover.

General characteristics

The LOVATO Electric limit switches have been designed to satisfy requirements comprising quick installation, easy wiring, simple setup, modularity, sturdiness and constant reliability.

The body cover is hinged at the bottom and removable.

The innovative locking bayonet mechanism permits to remove and reposition the operating head in the required configuration with no tools. The heads have axial rotation of 45° angles.

The auxiliary contact blocks are removable assuring remarkable wiring ease.

Operational characteristics

- Maximum operating rate: 3600 cycles/h
- Switching speed: 0.5...1.5m/s
- Mechanical life: >10 million cycles
- IEC conventional thermal current Ith: 10A
- UL/CSA and IEC/EN/BS 60947-5-1 designation:
 - A600 Q300 for KB... types
 - A300 Q300 for KM... types
- IEC rated insulation voltage Ui:
 - 690V for KB... types
 - 440V for KM... types
- IEC rated impulse withstand voltage Uimp:
 - 6kVAC for KB... types
 - 4kVAC for KM... types
- Class II insulation for KB only
- Contact resistance: <10mΩ
- Short-circuit backup protection: 10A gG/SC quick fuse
- Operators of aluminium-zinc alloy
- Housing:
 - KB... types: self-extinguishing double-insulation polymer thermoplastic
 - KM... types: aluminium-zinc alloy
- Cable entry: M20 standard supplied; PG13.5 and 1/2 NPT available (see the side note for details)
- Operating head fixing: locking bayonet insert
- Operating torque: 3Ncm / 4.25ozin
- Cable connection: self-releasing screw terminal
- Tightening torque:
 - Switch fixing: 2.5Nm / 22.1lb.in
 - Contact terminals: 0.8Nm / 7lb.in
 - Body lid screw fixing: 0.8Nm / 7lb.in
- Conductor section: 1 or 2 2.5mm² max / 16-14AWG
- Ambient conditions:
 - Operating temperature: -25...+70°C
 - Storage temperature: -40...+70°C
 - Pollution degree: 3
 - IEC degree of protection: IP20 for terminals
 - IEC degree of protection: IP65 for body housing.

Certifications and compliance

Certifications obtained: UL Listed for USA and Canada (cULus - File E93601), as Auxiliary Devices - Limit switches; EAC, CCC.

Compliant with standards: EN/BS 50047, IEC/EN/BS 60947-1, IEC/EN/BS 60947-5-1, IEC/EN/BS 60204-1, UL508, CSA C22.2 n° 14.

- ▶ Forward travel of snap action contacts
- ◀ Return travel of snap action contacts

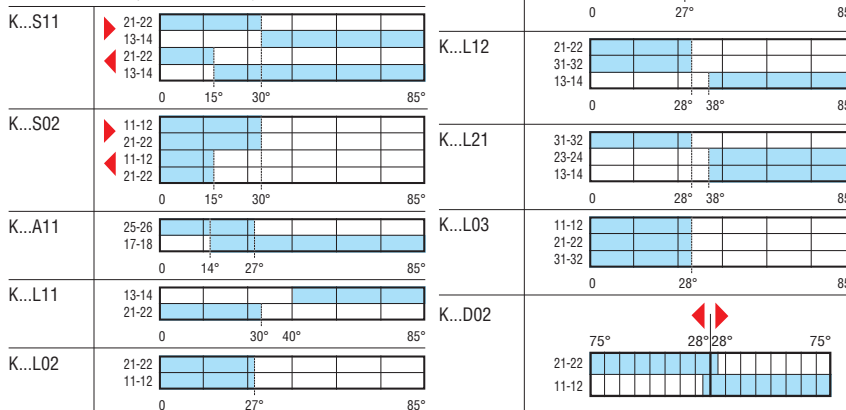

10 Limit, micro and foot switches

Limit switches, K series.

Two side cable entries. Dimensions compatible to EN/BS 50047

Roller lever plunger

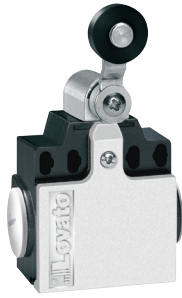

KCE1... - KCE2...
KNE1... - KNE2...

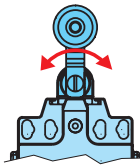

KCE3... - KNE3...

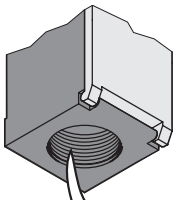

M20 CABLE ENTRY

For types with PG13.5 cable entry, add the letter P at the end of the order code while for 1/2 NPT, add N. E.g. KCE1S11P - KCE1S11N

Order code	Plastic body	Metal body	Contacts	Roller material	Qty per pkg	Wt
					n°	[kg]

Two side cable entries. Dimensions compatible to EN/BS 50047.

KCE1S11	KNE1S11	1NO+1NC	Plastic ①	5	④
KCE2S11	KNE2S11	Snap action ⑤	Metal ①	5	④
KCE3S11	KNE3S11		Rubber ②	5	④
KCE1S02	KNE1S02	2NC	Plastic ①	5	④
KCE2S02	KNE2S02	Snap action ⑤	Metal ①	5	④
KCE3S02	KNE3S02		Rubber ②	5	④
KCE1A11	KNE1A11	1NO+1NC	Plastic ①	5	④
KCE2A11	KNE2A11	Slow action make before break ①	Metal ①	5	④
KCE3A11	KNE3A11		Rubber ②	5	④
KCE1L11	KNE1L11	1NO+1NC	Plastic ①	5	④
KCE2L11	KNE2L11	Slow action make before break ⑤	Metal ①	5	④
KCE3L11	KNE3L11		Rubber ②	5	④
KCE1L02	KNE1L02	2NC	Plastic ①	5	④
KCE2L02	KNE2L02	Snap action ⑤	Metal ①	5	④
KCE3L02	KNE3L02		Rubber ②	5	④
KCE1L20	KNE1L20	2NO	Plastic ①	5	④
KCE2L20	KNE2L20	Snap action	Metal ①	5	④
KCE3L20	KNE3L20		Rubber ②	5	④

BI-DIRECTIONAL.

Two side cable entries. Dimensions compatible to EN/BS 50047.

KCE1D02	KNE1D02	2NC ⑥ independent	Plastic ①	5	④
---------	---------	-------------------	-----------	---	---

① Ø19x5mm = Ø0.75"x0.2".

② Ø50x10mm = Ø1.97"x0.39".

⑤ Direct (positive) opening action ; safety function according to IEC/EN/BS 60947-5-1.

⑥ Consult Technical support for information; see contact details on inside cover.

General characteristics

The LOVATO Electric limit switches have been designed to satisfy requirements comprising quick installation, easy wiring, simple setup, modularity, sturdiness and constant reliability.

The body cover is hinged at the bottom and removable. The innovative locking bayonet mechanism permits to remove and reposition the operating head in the required configuration with no tools. The heads have axial rotation of 90° angles.

The auxiliary contact blocks are removable assuring remarkable wiring ease.

Operational characteristics

- Maximum operating rate: 3600 cycles/h
- Switching speed: 0.5...1.5m/s
- Mechanical life: >10 million cycles
- IEC conventional thermal current Ith: 10A
- UL/CSA and IEC/EN/BS 60947-5-1 designation:
 - A600 Q300 for KC... types
 - A300 Q300 for KN... types
- IEC rated insulation voltage Ui:
 - 690VAC for KC... types
 - 440VAC for KN... types
- IEC rated impulse withstand voltage Uimp:
 - 6kV for KC... types
 - 4kV for KN... types
- Class II insulation for KC only
- Contact resistance: <10mΩ
- Short-circuit backup protection: 10A gG/SC quick fuse
- Operators of aluminium-zinc alloy
- Housing:
 - KC... types: self-extinguishing double-insulation polymer thermoplastic
 - KN... types: aluminium-zinc alloy
- Cable entry: M20 standard supplied; PG13.5 and 1/2 NPT available (see the side note for details)
- Operating head fixing: locking bayonet insert
- Operating torque: 3Ncm/4.25ozin
- Cable connection: self-releasing screw terminal
- Tightening torque:
 - Switch fixing: 2.5Nm / 22.1lb.in
 - Contact terminals: 0.8Nm / 7lb.in
 - Body lid screw fixing: 0.8Nm / 7lb.in
- Conductor section: 1 or 2 2.5mm² max / 16-14AWG
- Ambient conditions:
 - Operating temperature: -25...+70°C
 - Storage temperature: -40...+70°C
 - Pollution degree: 3
 - IEC degree of protection: IP20 for terminals
 - IEC degree of protection: IP65 for body housing.

Certifications and compliance

Certifications obtained: UL Listed for USA and Canada (cULus - File E93601), as Auxiliary Devices - Limit switches; EAC, CCC.

Compliant with standards: IEC/EN/BS 60947-1, IEC/EN/BS 60947-5-1, IEC/EN/BS 60204-1, UL508, CSA C22.2 n° 14.

- ▶ Forward travel of snap action contacts open
- ◀ Return travel of snap action contacts closed

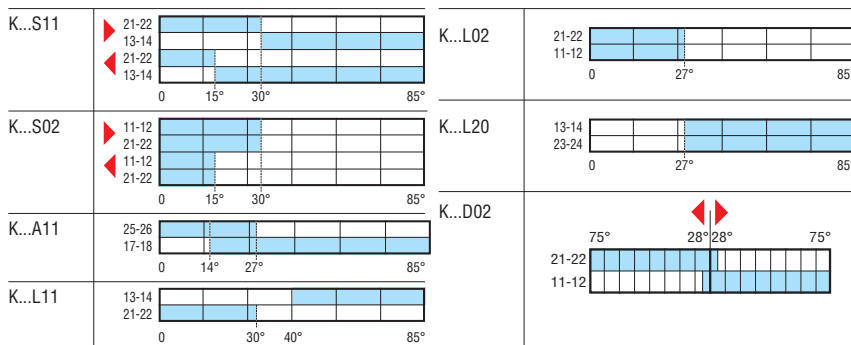

10 Limit, micro and foot switches

Limit switches, K series.

One bottom cable entry. Dimensions to EN/BS 50047



INDEX

Adjustable roller lever



KB... - KMF...

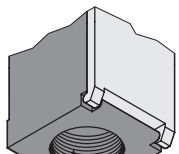
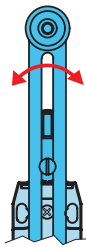

M20 CABLE ENTRY

For types with PG13.5 cable entry, add the letter P at the end of the order code while for 1/2 NPT, add N. E.g. KBF1S11P - KBF1S11N

Order code Plastic body	Order code Metal body	Contacts	Roller material	Qty per pkg n°	Wt [kg]
One bottom cable entry. Dimensions to EN/BS 50047.					
KBF1S11	KMF1S11	1NO+1NC	Plastic ①	5	⑤
KBF2S11	KMF2S11	Snap action ④	Metal ①	5	⑤
KBF3S11	KMF3S11		Rubber ②	5	⑤
KBF4S11	KMF4S11		Rubber ③	5	⑤
KBF1S02	KMF1S02		2NC	Plastic ①	5
KBF2S02	KMF2S02	Snap action ④	Metal ①	5	⑤
KBF3S02	KMF3S02		Rubber ②	5	⑤
KBF4S02	KMF4S02		Rubber ③	5	⑤
KBF1A11	KMF1A11	1NO+1NC	Plastic ①	5	⑤
KBF2A11	KMF2A11	Slow action make before break ④	Metal ①	5	⑤
KBF3A11	KMF3A11		Rubber ②	5	⑤
KBF4A11	KMF4A11		Rubber ③	5	⑤
KBF1L11	KMF1L11		1NO+1NC	Plastic ①	5
KBF2L11	KMF2L11	Snap action ④	Metal ①	5	⑤
KBF3L11	KMF3L11		Rubber ②	5	⑤
KBF4L11	KMF4L11		Rubber ③	5	⑤
KBF1L02	KMF1L02	2NC	Plastic ①	5	⑤
KBF2L02	KMF2L02	Snap action ④	Metal ①	5	⑤
KBF3L02	KMF3L02		Rubber ②	5	⑤
KBF4L02	KMF4L02		Rubber ③	5	⑤
KBF1L20	KMF1L20	2NO	Plastic ①	5	⑤
KBF2L20	KMF2L20	Snap action	Metal ①	5	⑤
KBF3L20	KMF3L20		Rubber ②	5	⑤
KBF4L20	KMF4L20		Rubber ③	5	⑤
KBF1L12	KMF1L12	1NO+2NC	Plastic ①	5	⑤
KBF2L12	KMF2L12	Snap action ④	Metal ①	5	⑤
KBF3L12	KMF3L12		Rubber ②	5	⑤
KBF4L12	KMF4L12		Rubber ③	5	⑤
KBF1L21	KMF1L21		2NO+1NC	Plastic ①	5
KBF2L21	KMF2L21	Snap action ④	Metal ①	5	⑤
KBF3L21	KMF3L21		Rubber ②	5	⑤
KBF4L21	KMF4L21		Rubber ③	5	⑤
KBF1L03	KMF1L03	3NC	Plastic ①	5	⑤
KBF2L03	KMF2L03	Snap action ④	Metal ①	5	⑤
KBF3L03	KMF3L03		Rubber ②	5	⑤
KBF4L03	KMF4L03		Rubber ③	5	⑤

BI-DIRECTIONAL.
One bottom cable entry. Dimensions to EN/BS 50047.

KBF1D02	KMF1D02	2NC ④ independent	Plastic ①	5	⑤
---------	---------	-------------------	-----------	---	---

- ① Ø19x5mm = Ø0.75x0.2".
- ② Ø50x10mm = Ø1.97x0.34".
- ③ Ø50x10mm (Ø1.97x0.35") with offset alignment.
- ④ Direct (positive) opening action ⇨; safety function according to IEC/EN/BS 60947-5-1.
- ⑤ Consult Technical support for information; see contact details on inside cover.

General characteristics

The LOVATO Electric limit switches have been designed to satisfy requirements comprising quick installation, easy wiring, simple setup, modularity, sturdiness and constant reliability.

The body cover is hinged at the bottom and removable.

The innovative locking bayonet mechanism permits to remove and reposition the operating head in the required configuration with no tools. The heads have axial rotation of 180° angles.

The auxiliary contact blocks are removable assuring remarkable wiring ease.

Operational characteristics

- Maximum operating rate: 3600 cycles/h
- Switching speed: 0.5...1.5m/s
- Mechanical life: >10 million cycles
- IEC conventional thermal current Ith: 10A
- UL/CSA and IEC/EN/BS 60947-5-1 designation:
 - A600 Q300 for KB... types
 - A300 Q300 for KM... types
- IEC rated insulation voltage Ui:
 - 690V for KB... types
 - 440V for KM... types
- IEC rated impulse withstand voltage Uimp:
 - 6kVAC for KB... types
 - 4kVAC for KM... types
- Class II insulation for KB only
- Contact resistance: <10mΩ
- Short-circuit backup protection: 10A gG/SC quick fuse
- Operators of aluminium-zinc alloy
- Housing:
 - KB... types: self-extinguishing double-insulation polymer thermoplastic
 - KM... types: aluminium-zinc alloy
- Cable entry: M20 standard supplied; PG13.5 and 1/2 NPT available (see the side note for details)
- Operating head fixing: locking bayonet insert
- Operating force: 3Ncm/4.25ozin
- Cable connection: self-releasing screw terminal
- Tightening torque:
 - Switch fixing: 2.5Nm / 22.1lb.in
 - Contact terminals: 0.8Nm / 7lb.in
 - Body lid screw fixing: 0.8Nm / 7lb.in
- Conductor section: 1 or 2 2.5mm² max / 16-14AWG
- Ambient conditions:
 - Operating temperature: -25...+70°C
 - Storage temperature: -40...+70°C
 - Pollution degree: 3
 - IEC degree of protection: IP20 for terminals
 - IEC degree of protection: IP65 for body housing.

Certifications and compliance

Certifications obtained: UL Listed for USA and Canada (cULus - File E93601), as Auxiliary Devices - Limit switches; EAC, CCC.

Compliant with standards: EN/BS 50047, IEC/EN/BS 60947-1, IEC/EN/BS 60947-5-1, IEC/EN/BS 60204-1, UL508, CSA C22.2 n° 14.

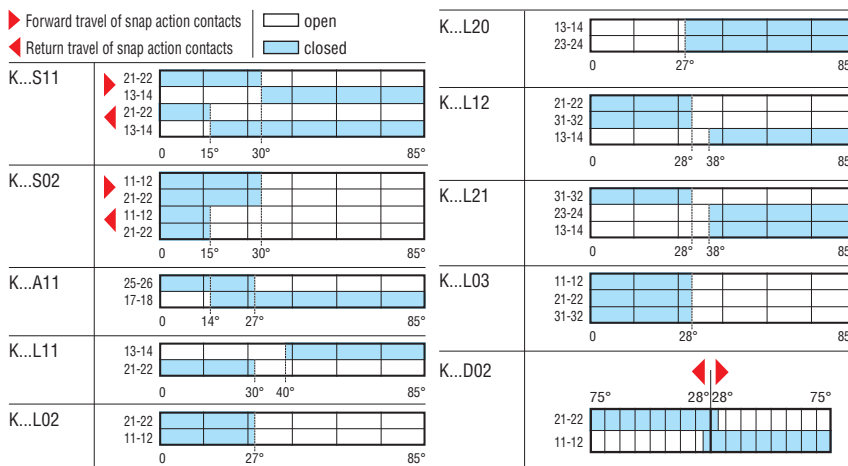

10 Limit, micro and foot switches

Limit switches, K series.

Two side cable entries. Dimensions compatible to EN/BS 50047

Adjustable roller lever



KCF... - KNF...

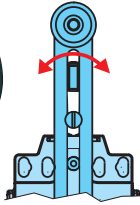

Order code	Plastic body	Metal body	Contacts	Roller material	Qty per pkg	Wt [kg]
------------	--------------	------------	----------	-----------------	-------------	---------

Two side cable entries. Dimensions compatible to EN/BS 50047.

KCF1S11	KNF1S11	1NO+1NC Snap action	Plastic	5	4
KCF2S11	KNF2S11		Metal	5	
KCF3S11	KNF3S11		Rubber	5	
KCF4S11	KNF4S11		Rubber offset align.	5	
KCF1S02	KNF1S02	2NC Snap action	Plastic	5	4
KCF2S02	KNF2S02		Metal	5	
KCF3S02	KNF3S02		Rubber	5	
KCF4S02	KNF4S02		Rubber offset align.	5	
KCF1A11	KNF1A11	1NO+1NC Slow action make before break	Plastic	5	4
KCF2A11	KNF2A11		Metal	5	
KCF3A11	KNF3A11		Rubber	5	
KCF4A11	KNF4A11		Rubber offset align.	5	
KCF1L11	KNF1L11	1NO+1NC Snap action	Plastic	5	4
KCF2L11	KNF2L11		Metal	5	
KCF3L11	KNF3L11		Rubber	5	
KCF4L11	KNF4L11		Rubber offset align.	5	
KCF1L02	KNF1L02	2NC Snap action	Plastic	5	4
KCF2L02	KNF2L02		Metal	5	
KCF3L02	KNF3L02		Rubber	5	
KCF4L02	KNF4L02		Rubber offset align.	5	
KCF1L20	KNF1L20	2NO Snap action	Plastic	5	4
KCF2L20	KNF2L20		Metal	5	
KCF3L20	KNF3L20		Rubber	5	
KCF4L20	KNF4L20		Rubber offset align.	5	

① Ø19x5mm = Ø0.75x0.2".

② Ø50x10mm = Ø1.97x0.34".

⊕ Direct (positive) opening action ⊖ safety function according to IEC/EN/BS 60947-5-1.

Ⓜ Consult Technical support for information; see contact details on inside cover.

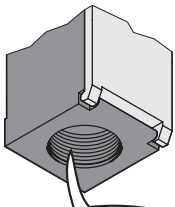

M20 CABLE ENTRY

For types with PG13.5 cable entry, add the letter P at the end of the order code while for 1/2 NPT, add N. E.g. KCF1S11P - KNF1S11N

General characteristics

The LOVATO Electric limit switches have been designed to satisfy requirements comprising quick installation, easy wiring, simple setup, modularity, sturdiness and constant reliability.

The body cover is hinged at the bottom and removable. The innovative locking bayonet mechanism permits to remove and reposition the operating head in the required configuration with no tools. The heads have axial rotation of 180° angles.

The auxiliary contact blocks are removable assuring remarkable wiring ease.

Operational characteristics

- Maximum operating rate: 3600 cycles/h
- Switching speed: 0.5...1.5m/s
- Mechanical life: >10 million cycles
- IEC conventional thermal current Ith: 10A
- UL/CSA and IEC/EN/BS 60947-5-1 designation:
 - A600 Q300 for KC... types
 - A300 Q300 for KN... types
- IEC rated insulation voltage Ui:
 - 690VAC for KC... types
 - 440VAC for KN... types
- IEC rated impulse withstand voltage Uimp:
 - 6kV for KC... types
 - 4kV for KN... types
- Class II insulation for KC only
- Contact resistance: <10mΩ
- Short-circuit backup protection: 10A gG/SC quick fuse
- Operators of aluminium-zinc alloy
- Housing:
 - KC... types: self-extinguishing double-insulation polymer thermoplastic
 - KN... types: aluminium-zinc alloy
- Cable entry: M20 standard supplied; PG13.5 and 1/2 NPT available (see the side note for details)
- Operating head fixing: locking bayonet insert
- Operating force: 3Ncm/4.25ozin
- Cable connection: self-releasing screw terminal
- Tightening torque:
 - Switch fixing: 2.5Nm / 22.1lb.in
 - Contact terminals: 0.8Nm / 7lb.in
 - Body lid screw fixing: 0.8Nm / 7lb.in
- Conductor section: 1 or 2 2.5mm² max / 16-14AWG
- Ambient conditions:
 - Operating temperature: -25...+70°C
 - Storage temperature: -40...+70°C
 - Pollution degree: 3
 - IEC degree of protection: IP20 for terminals
 - IEC degree of protection: IP65 for body housing.

Certifications and compliance

Certifications obtained: UL Listed for USA and Canada (cULus - File E93601), as Auxiliary Devices - Limit switches; EAC, CCC.

Compliant with standards: EN/BS 50047, IEC/EN/BS 60947-1, IEC/EN/BS 60947-5-1, IEC/EN/BS 60204-1, UL508, CSA C22.2 n° 14.

- ▶ Forward travel of snap action contacts
- ◀ Return travel of snap action contacts

□ open

■ closed

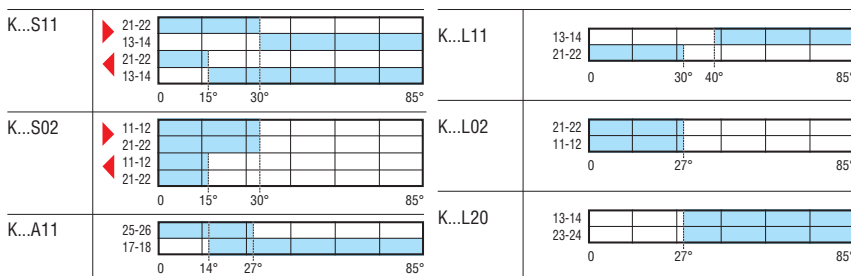

10 Limit, micro and foot switches

Limit switches, K series. One bottom cable entry. Dimensions to EN/BS 50047
Two side cable entries. Dimensions compatible to EN/BS 50047

Ceramic rod lever



KBH... - KMH...

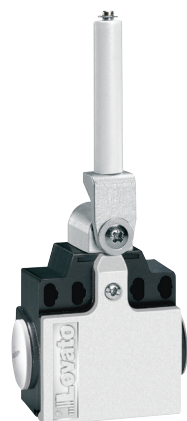
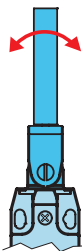

KCH... - KNH...

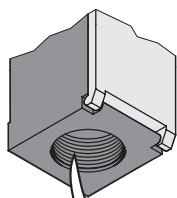

M20 CABLE ENTRY

For types with PG13.5 cable entry, add the letter P at the end of the order code while for 1/2 NPT, add N. E.g. KBH1S11P - KBH1S11N

Order code Plastic body	Metal body	Contacts	Rod material	Qty per pkg n°	Wt [kg]
One bottom cable entry. Dimensions to EN/BS 50047.					
KBH1S11	KMH1S11	1NO+1NC Snap action ①	Ceramic	5	②
KBH1S02	KMH1S02	2NC Snap action ①	Ceramic	5	②
KBH1A11	KMH1A11	1NO+1NC Slow action make before break ①	Ceramic	5	②
KBH1L11	KMH1L11	1NO+1NC Snap action ①	Ceramic	5	②
KBH1L02	KMH1L02	2NC Snap action ①	Ceramic	5	②
KBH1L20	KMH1L20	2NO Snap action	Ceramic	5	②
KBH1L12	KMH1L12	1NO+2NC Snap action ①	Ceramic	5	②
KBH1L21	KMH1L21	2NO+1NC Snap action ①	Ceramic	5	②
KBH1L03	KMH1L03	3NC Snap action ①	Ceramic	5	②

Two side cable entries. Dimensions compatible to EN/BS 50047.

KCH1S11	KNH1S11	1NO+1NC Snap action ①	Ceramic	5	②
KCH1S02	KNH1S02	2NC Snap action ①	Ceramic	5	②
KCH1A11	KNH1A11	1NO+1NC Slow action make before break ①	Ceramic	5	②
KCH1L11	KNH1L11	1NO+1NC Snap action ①	Ceramic	5	②
KCH1L02	KNH1L02	2NC Snap action ①	Ceramic	5	②
KCH1L20	KNH1L20	2NO Snap action	Ceramic	5	②

① Direct (positive) opening action Ⓢ safety function according to IEC/EN/BS 60947-5-1.
② Consult Technical support for information; see contact details on inside cover.

General characteristics

The LOVATO Electric limit switches have been designed to satisfy requirements comprising quick installation, easy wiring, simple setup, modularity, sturdiness and constant reliability.

The body cover is hinged at the bottom and removable.

The innovative locking bayonet mechanism permits to remove and reposition the operating head in the required configuration with no tools. The heads have axial rotation of 45° angles.

The auxiliary contact blocks are removable assuring remarkable wiring ease.

Operational characteristics

- Maximum operating rate: 3600 cycles/h
- Switching speed: 0.5...1.5m/s
- Mechanical life: >10 million cycles
- IEC conventional thermal current Ith: 10A
- UL/CSA and IEC/EN/BS 60947-5-1 designation:
 - A600 Q300 for KB...-KC... types
 - A300 Q300 for KM...-KN... types
- IEC rated insulation voltage Ui:
 - 690VAC for KB...-KC... types
 - 440VAC for KM...-KN... types
- IEC rated impulse withstand voltage Uimp:
 - 6kV for KB...-KC... types
 - 4kV for KM...-KN... types
- Class II insulation for KB...-KC... only
- Contact resistance: <10mΩ
- Short-circuit backup protection: 10A gG/SC quick fuse
- Operators of aluminium-zinc alloy
- Housing:
 - KB...-KC... types: self-extinguishing double-insulation polymer thermoplastic
 - KM...-KN... types: aluminium-zinc alloy
- Cable entry: M20 standard supplied; PG13.5 and 1/2 NPT available (see the side note for details)
- Operating head fixing: locking bayonet insert
- Operating torque: 3Ncm/4.25ozin
- Cable connection: self-releasing screw terminal
- Tightening torque:
 - Switch fixing: 2.5Nm / 22.1lb.in
 - Contact terminals: 0.8Nm / 7lb.in
 - Body lid screw fixing: 0.8Nm / 7lb.in
- Conductor section: 1 or 2 2.5mm² max / 16-14AWG
- Ambient conditions:
 - Operating temperature: -25...+70°C
 - Storage temperature: -40...+70°C
 - Pollution degree: 3
 - IEC degree of protection: IP20 for terminals
 - IEC degree of protection: IP65 for body housing.

Certifications and compliance

Certifications obtained: UL Listed for USA and Canada (cULus - File E93601), as Auxiliary Devices - Limit switches; EAC, CCC.

Compliant with standards: EN/BS 50047, IEC/EN/BS 60947-1, IEC/EN/BS 60947-5-1, IEC/EN/BS 60204-1, UL508, CSA C22.2 n° 14.

▶ Forward travel of snap action contacts □ open
◀ Return travel of snap action contacts ■ closed

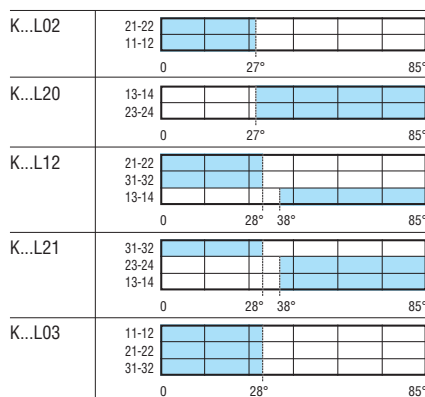
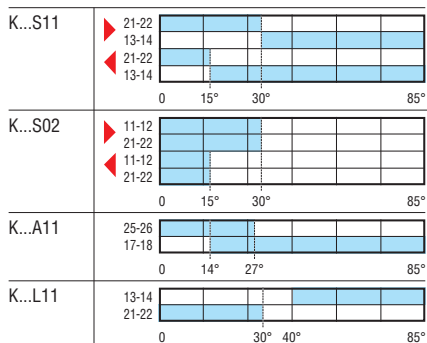

10 Limit, micro and foot switches

Limit switches, K series. One bottom cable entry. Dimensions to EN/BS 50047
Two side cable entries. Dimensions compatible to EN/BS 50047

Adjustable rod lever



KBL... - KML...

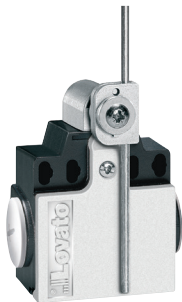

KCL... - KNL...

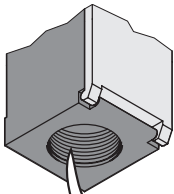

M20 CABLE ENTRY

For types with PG13.5 cable entry, add the letter P at the end of the order code while for 1/2 NPT, add N. E.g. KBL1S11P - KBL1S11N

Order code Plastic body	Order code Metal body	Contacts	Rod material	Qty per pkg	Wt [kg]
-------------------------	-----------------------	----------	--------------	-------------	---------

One bottom cable entry. Dimensions to EN/BS 50047.

KBL1S11	KML1S11	1NO+1NC	Plastic	5	⊕
KBL2S11	KML2S11	Slow action ⊕	Steel	5	⊕
KBL1S02	KML1S02	2NC	Plastic	5	⊕
KBL2S02	KML2S02	Slow action ⊕	Steel	5	⊕
KBL1A11	KML1A11	1NO+1NC	Plastica	5	⊕
KBL2A11	KML2A11	Slow action make before break ⊕	Steel	5	⊕
KBL1L11	KML1L11	1NO+1NC	Plastic	5	⊕
KBL2L11	KML2L11	Slow action ⊕	Steel	5	⊕
KBL1L02	KML1L02	2NC	Plastic	5	⊕
KBL2L02	KML2L02	Slow action ⊕	Steel	5	⊕
KBL1L20	KML1L20	2NO	Plastic	5	⊕
KBL2L20	KML2L20	Slow action	Steel	5	⊕
KBL1L12	KML1L12	1NO+2NC	Plastic	5	⊕
KBL2L12	KML2L12	Slow action ⊕	Steel	5	⊕
KBL1L21	KML1L21	2NO+1NC	Plastic	5	⊕
KBL2L21	KML2L21	Slow action ⊕	Steel	5	⊕
KBL1L03	KML1L03	3NC	Plastic	5	⊕
KBL2L03	KML2L03	Slow action ⊕	Steel	5	⊕

Two side cable entries. Dimensions compatible to EN/BS 50047.

KCL1S11	KNL1S11	1NO+1NC	Plastic	5	⊕
KCL2S11	KNL2S11	Slow action ⊕	Steel	5	⊕
KCL1S02	KNL1S02	2NC	Plastic	5	⊕
KCL2S02	KNL2S02	Slow action ⊕	Steel	5	⊕
KCL1A11	KNL1A11	1NO+1NC	Plastic	5	⊕
KCL2A11	KNL2A11	Slow action make before break ⊕	Steel	5	⊕
KCL1L11	KNL1L11	1NO+1NC	Plastic	5	⊕
KCL2L11	KNL2L11	Slow action ⊕	Steel	5	⊕
KCL1L02	KNL1L02	2NC	Plastic	5	⊕
KCL2L02	KNL2L02	Slow action ⊕	Steel	5	⊕
KCL1L20	KNL1L20	2NO	Plastic	5	⊕
KCL2L20	KNL2L20	Slow action	Steel	5	⊕

BI-DIRECTIONAL.

One bottom cable entry. Dimensions to EN/BS 50047.

KBL1D02	KML1D02	2NC ⊕ independent	Plastic	5	⊕
KBL2D02	KML2D02	2NC ⊕ independent	Steel	5	⊕

⊕ Direct (positive) opening action ⊖ safety function according to IEC/EN/BS 60947-5-1.

⊕ Consult Technical support for information; see contact details on inside cover.

General characteristics

The LOVATO Electric limit switches have been designed to satisfy requirements comprising quick installation, easy wiring, simple setup, modularity, sturdiness and constant reliability.

The body cover is hinged at the bottom and removable. The innovative locking bayonet mechanism permits to remove and reposition the operating head in the required configuration with no tools. The heads have axial rotation of 90° angles (180° for KC... and KN... types).

The auxiliary contact blocks are removable assuring remarkable wiring ease.

Operational characteristics

- Maximum operating rate: 3600 cycles/h
- Switching speed: 0.5...1.5m/s
- Mechanical life: >10 million cycles
- IEC conventional thermal current Ith: 10A
- UL/CSA and IEC/EN/BS 60947-5-1 designation:
 - A600 Q300 for KB...-KC... types
 - A300 Q300 for KM...-KN... types
- IEC rated insulation voltage Ui:
 - 690VAC for KB...-KC... types
 - 440VAC for KM...-KN... types
- IEC rated impulse withstand voltage Uimp:
 - 6kV for KB...-KC... types
 - 4kV for KM...-KN... types
- Class II insulation for KB...-KC... only
- Contact resistance: <10mΩ
- Short-circuit backup protection: 10A gG/SC quick fuse
- Operators of aluminium-zinc alloy
- Housing:
 - KB...-KC... types: self-extinguishing double-insulation polymer thermoplastic
 - KM...-KN... types: aluminium-zinc alloy
- Cable entry: M20 standard supplied; PG13.5 and 1/2 NPT available (see the side note for details)
- Operating head fixing: locking bayonet insert
- Operating force: 3Ncm/4.25ozin
- Cable connection: self-releasing screw terminal
- Tightening torque:
 - Switch fixing: 2.5Nm / 22.1lb.in
 - Contact terminals: 0.8Nm / 7lb.in
 - Body lid screw fixing: 0.8Nm / 7lb.in
- Conductor section: 1 or 2 2.5mm² max / 16-14AWG
- Ambient conditions:
 - Operating temperature: -25...+70°C
 - Storage temperature: -40...+70°C
 - Pollution degree: 3
 - IEC degree of protection: IP20 for terminals
 - IEC degree of protection: IP65 for body housing.

Certifications and compliance

Certifications obtained: UL Listed for USA and Canada (cULus - File E93601), as Auxiliary Devices - Limit switches; EAC, CCC.

Compliant with standards: EN/BS 50047, IEC/EN/BS 60947-1, IEC/EN/BS 60947-5-1, IEC/EN/BS 60204-1, UL508, CSA C22.2 n° 14.

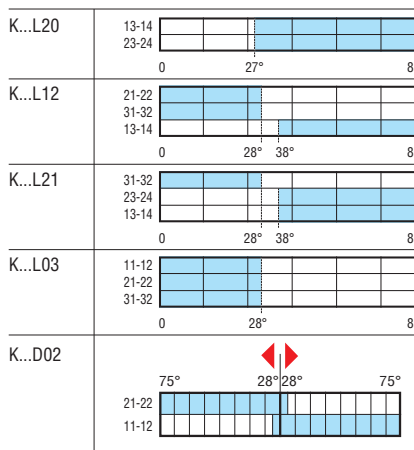
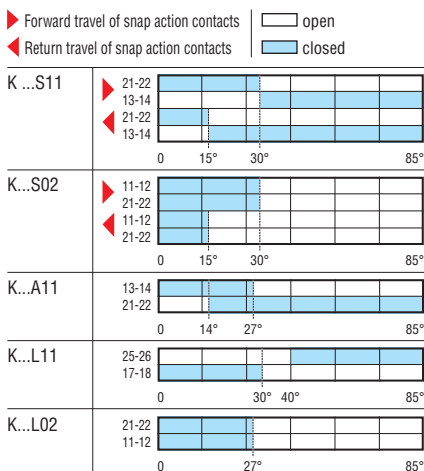

10 Limit, micro and foot switches

Limit switches, K series. One bottom cable entry. Dimensions to EN/BS 50047
Two side cable entries. Dimensions compatible to EN/BS 50047



INDEX

Wobble stick, omnidirectional

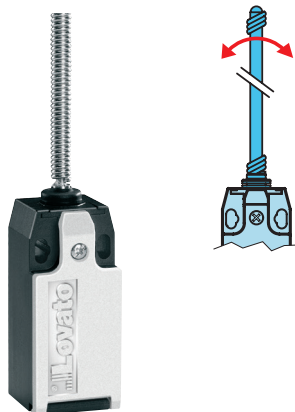

KBM1... - KMM1...



KCM2... - KNM2...

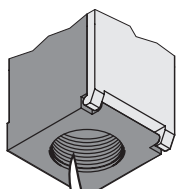

M20 CABLE ENTRY

For types with PG13.5 cable entry, add the letter P at the end of the order code while for 1/2 NPT, add N. E.g. KBM1S11P - KBM1S11N

Order code	Plastic body	Metal body	Contacts	Rod material	Qty per pkg	Wt
					n°	[kg]

One bottom cable entry. Dimensions to EN/BS 50047.

KBM1S11	KMM1S11	1NO+1NC	Flexible	5	1
KBM2S11	KMM2S11	Snap action	Semirigid	5	1
KBM1S02	KMM1S02	2NC	Flexible	5	1
KBM2S02	KMM2S02	Snap action	Semirigid	5	1
KBM1A11	KMM1A11	1NO+1NC	Flexible	5	1
KBM2A11	KMM2A11	Slow action make before break	Semirigid	5	1
KBM1L11	KMM1L11	1NO+1NC	Flexible	5	1
KBM2L11	KMM2L11	Slow action	Semirigid	5	1
KBM1L02	KMM1L02	2NC	Flexible	5	1
KBM2L02	KMM2L02	Slow action	Semirigid	5	1
KBM1L20	KMM1L20	2NO	Flexible	5	1
KBM2L20	KMM2L20	Slow action	Semirigid	5	1
KBM1L12	KMM1L12	1NO+2NC	Flexible	5	1
KBM2L12	KMM2L12	Slow action	Semirigid	5	1
KBM1L21	KMM1L21	2NO+1NC	Flexible	5	1
KBM2L21	KMM2L21	Slow action	Semirigid	5	1
KBM1L03	KMM1L03	3NC	Flexible	5	1
KBM2L03	KMM2L03	Slow action	Semirigid	5	1

Two side cable entries. Dimensions compatible to EN/BS 50047.

KCM1S11	KNM1S11	1O+1NC	Flexible	5	1
KCM2S11	KNM2S11	Snap action	Semirigid	5	1
KCM1S02	KNM1S02	2NC	Flexible	5	1
KCM2S02	KNM2S02	Snap action	Semirigid	5	1
KCM1A11	KNM1A11	1NO+1NC	Flexible	5	1
KCM2A11	KNM2A11	Slow action make before break	Semirigid	5	1
KCM1L11	KNM1L11	1NO+1NC	Flexible	5	1
KCM2L11	KNM2L11	Slow action	Semirigid	5	1
KCM1L02	KNM1L02	2NC	Flexible	5	1
KCM2L02	KNM2L02	Slow action	Semirigid	5	1
KCM1L20	KNM1L20	2NO	Flexible	5	1
KCM2L20	KNM2L20	Slow action	Semirigid	5	1

1 Consult Technical support for information; see contact details on inside cover.

General characteristics

The LOVATO Electric limit switches have been designed to satisfy requirements comprising quick installation, easy wiring, simple setup, modularity, sturdiness and constant reliability.

The body cover is hinged at the bottom and removable.

The innovative locking bayonet mechanism permits to remove and reposition the operating head in the required configuration with no tools.

The auxiliary contact blocks are removable assuring remarkable wiring ease.

Operational characteristics

- Maximum operating rate: 3600 cycles/h
- Switching speed: 0.5...1.5m/s
- Mechanical life: >10 million cycles
- IEC conventional thermal current Ith: 10A
- UL/CSA and IEC/EN/BS 60947-5-1 designation:
 - A600 Q300 for KB...-KC... types
 - A300 Q300 for KM...-KN... types
- IEC rated insulation voltage Ui:
 - 690VAC for KB...-KC... types
 - 440VAC for KM...-KN... types
- IEC rated impulse withstand voltage Uimp:
 - 6kV for KB...-KC... types
 - 4kV for KM...-KN... types
- Class II insulation for KB...-KC... only
- Contact resistance: <10mΩ
- Short-circuit backup protection: 10A gG/SC quick fuse
- Operators of aluminium-zinc alloy
- Housing:
 - KB...-KC... types: self-extinguishing double-insulation polymer thermoplastic
 - KM...-KN... types: aluminium-zinc alloy
- Cable entry: M20 standard supplied; PG13.5 and 1/2 NPT available (see the side note for details)
- Operating head fixing: locking bayonet insert
- Operating torque: 1Ncm/1.42ozin
- Cable connection: self-releasing screw terminal
- Tightening torque:
 - Switch fixing: 2.5Nm / 22.1lb.in
 - Contact terminals: 0.8Nm / 7lb.in
 - Body lid screw fixing: 0.8Nm / 7lb.in
- Conductor section: 1 or 2 2.5mm² max / 16-14AWG
- Ambient conditions:
 - Operating temperature: -25...+70°C
 - Storage temperature: -40...+70°C
 - Pollution degree: 3
 - IEC degree of protection: IP20 for terminals
 - IEC degree of protection: IP65 for body housing.

Certifications and compliance

Certifications obtained: UL Listed for USA and Canada (cULus - File E93601), as Auxiliary Devices - Limit switches; EAC, CCC.

Compliant with standards: EN/BS 50047, IEC/EN/BS 60947-1, IEC/EN/BS 60947-5-1, IEC/EN/BS 60204-1, UL508, CSA C22.2 n° 14.

- ▶ Forward travel of snap action contacts
- ◀ Return travel of snap action contacts

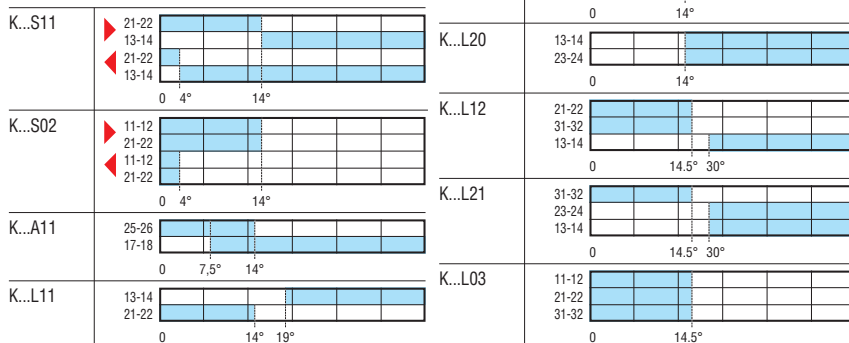

10 Limit, micro and foot switches

Limit switches, K series.

Accessories and spare parts for KB - KC - KM and KN type limit switches

Contact blocks



KXB...

Body complete with contact block



KXCB... - KXCM...



KXCC... - KXCN...

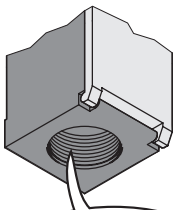

M20 CABLE ENTRY

For types with PG13.5 cable entry, add the letter P at the end of the order code while for 1/2 NPT, add N. E.g. KXCCL11P - KXCCL11N

- ▶ Forward travel of snap action contacts open
- ◀ Return travel of snap action contacts closed

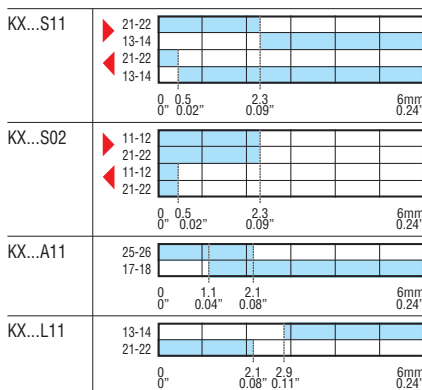

Order code	Contacts	Qty per pkg	Wt [kg]
KXBS11	1NO+1NC Snap action ①②	5	0.022
KXBS02	2NC Snap action ①②	5	0.022
KXBA11	1NO+1NC Slow action make before break ①②	5	0.022
KXBL11	1NO+1NC Slow action ②	5	0.022
KXBL02	2NC Slow action ②	5	0.022
KXBL20	2NO Slow action	5	0.022
KXBL12	1NO+2NC Slow action ②③	5	0.026
KXBL21	2NO+1NC Slow action ②③	5	0.026
KXBL03	3NC Slow action ②③	5	0.026

- ① Not suitable for key operated KBN / KCN, hinged operating KBP / KCP / KMP / KNP and slotted lever KBQ / KCQ / KMQ / KNQ types.
- ② Direct (positive) opening action Ⓢ; safety function according to IEC/EN/BS 60947-5-1.
- ③ Not suitable for KC and KN types, KG and KR foot switches.

Order code Plastic body	Order code Metal body	Contacts	Qty per pkg	Wt [kg]
One bottom cable entry. Dimensions to EN/BS 50047.				
KXCBS11	KXCMS11	1NO+1NC Snap action ①②	5	④
KXCBS02	KXCMS02	2NC Snap action ①②	5	④
KXCBA11	KXCMA11	1NO+1NC Slow action make before break ①②	5	④
KXCBL11	KXCML11	1NO+1NC Slow action ②	5	④
KXCBL02	KXCML02	2NC Slow action ②	5	④
KXCBL20	KXCML20	2NO Slow action	5	④
KXCBL12	KXCML12	1NO+2NC Slow action ②③	5	④
KXCBL21	KXCML21	2NO+1NC Slow action ②③	5	④
KXCBL03	KXCML03	3NC Slow action ②③	5	④
Two side cable entries. Dimensions compatible to EN/BS 50047.				
KXCBS11	KXCNS11	1NO+1NC Snap action ①②	5	④
KXCBS02	KXCNS02	2NC Snap action ①②	5	④
KXCCA11	KXCNA11	1NO+1NC Slow action make before break ①②	5	④
KXCCL11	KXCNL11	1NO+1NC Slow action ②	5	④
KXCCL02	KXCNL02	2NC Slow action ②	5	④
KXCCL20	KXCNL20	2NO Slow action	5	④

- ④ Not suitable for key operated KBN / KCN, hinged operating KBP / KCP / KMP / KNP and slotted lever KBQ / KCQ / KMQ / KNQ types.
- ⑤ Direct (positive) opening action Ⓢ; safety function according to IEC/EN/BS 60947-5-1.
- ⑥ Not suitable for KC and KN types.
- ⑦ Consult Technical support for information; see contact details on inside cover.

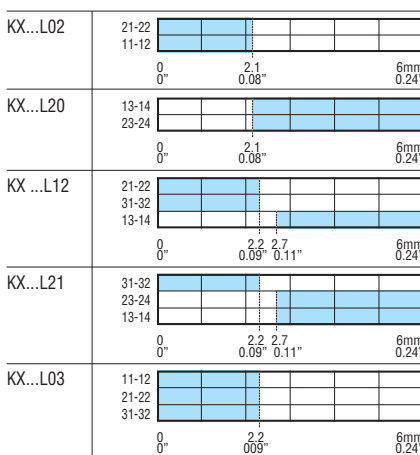

General characteristics

The KXB... contact blocks can be used with the K series of limit switches. Combinations of 2 contacts with slow or snap action and, for KB... and KM... types only, 3 slow action contacts are available.

The NC contacts have direct opening operation, a specific safety principle.

The particular four-point contacts warrant high conductivity in any sort of application. The removal of the contacts from the limit switch body provides remarkable wiring ease and reduces installation time as well.

The KXC... bodies, complete with auxiliary contacts, can be used as spare parts for the K series limit switches or coupled with the KXA... operating heads, to obtain complete limit switches in the required configurations.

The body cover is hinged at the bottom and removable to have the best access. Each body includes the innovative locking bayonet mechanism of the operating head. Plastic and metal types are available.

Operational characteristics

- Mechanical life: >10 million cycles
- IEC conventional thermal current Ith: 10A
- Conductivity: 10mA 5V
- UL/CSA and IEC/EN/BS 60947-5-1 designation:
 - A600 Q300 for KXCB...-KXCC... types
 - A300 Q300 for KXCM...-KXCN... types
- IEC rated insulation voltage Ui:
 - 690VAC for KXCB...-KXCC... types
 - 440VAC for KXCM...-KXCN... types
- IEC rated impulse withstand voltage Uimp:
 - 6kV for KXCB...-KXCC... types
 - 4kV for KXCM...-KXCN... types
- Class II insulation for KXCB...-KXCC... only
- Contact resistance: <10mΩ
- Short-circuit backup protection: 10A gG/SC quick fuse
- Housing:
 - KXCB...-KXCC... types: self-extinguishing double-insulation polymer thermoplastic
 - KXCM...-KXCN... types: aluminium-zinc alloy
- Cable entry: M20 standard supplied; PG13.5 and 1/2 NPT available (see the side note for details)
- Operating head fixing: locking bayonet insert
- Cable connection: self-releasing screw terminal
- Tightening torque:
 - Switch fixing: 2.5Nm / 22.1lb.in
 - Contact terminals: 0.8Nm / 7lb.in
 - Body lid screw fixing: 0.8Nm / 7lb.in
- Conductor section: 1 or 2 2.5mm² max / 16-14AWG
- Ambient conditions:
 - Operating temperature: -25...+70°C
 - Storage temperature: -40...+70°C
 - Pollution degree: 3
 - IEC degree of protection: IP20 for terminals
 - IEC degree of protection: IP65 for body housing.

Certifications and compliance

Certifications obtained: UL Listed for US and Canada (File E93601), as Auxiliary Devices for KX C... body types only. UL Recognized for USA and Canada (cURus - File E93601) as component - Auxiliary devices for contact blocks only; products having this type of marking are intended for use as components of complete workshop-assembled equipment; EAC for all.

Comply with standards: EN/BS50047, IEC/EN/BS 60947-1, IEC/EN/BS 60947-5-1, IEC/EN/BS 60204-1, UL508, CSA C22.2 n° 14.

10 Limit, micro and foot switches

Limit switches, K series.

Accessories and spare parts for KB, KC, KM and KN type limit switches

INDEX

Operating heads

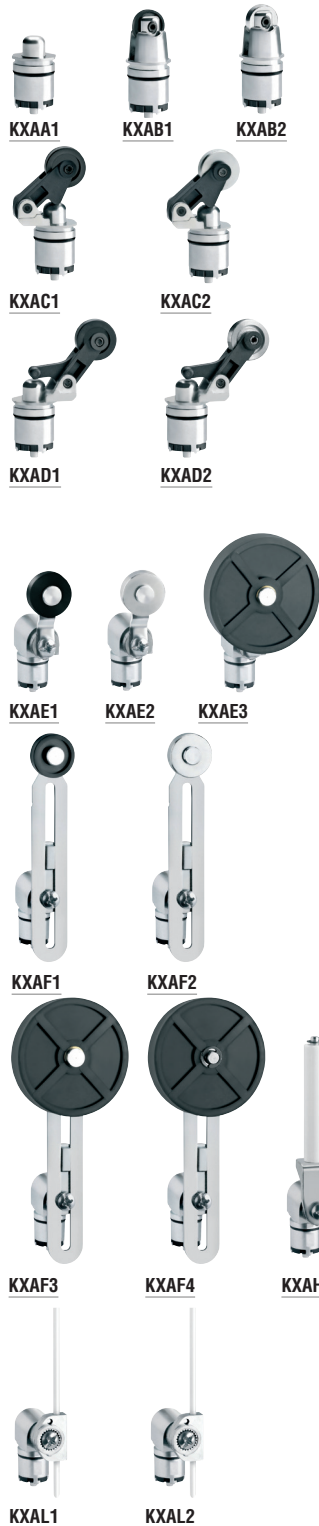

Order code	Description	Qty per pkg	Wt
		n°	[kg]
KXAA1	Top push rod plunger	5	0.013
KXAB1	Plastic top roller push plunger	5	0.019
KXAB2	Metal top roller push plunger	5	0.020
KXAC1	Plastic roller centre push lever	5	0.018
KXAC2	Metal roller centre push lever	5	0.022
KXAD1	Plastic roller side push lever	5	0.018
KXAD2	Metal roller side push lever	5	0.023
KXAE1	Plastic roller lever plunger	5	0.039
KXAE2	Metal roller lever plunger	5	0.048
KXAE3	Rubber Ø50x10mm [Ⓜ] roller lever plunger	5	0.058
KXAF1	Adjustable plastic roller lever Ø19x5mm [Ⓛ]	5	0.055
KXAF2	Adjustable metal roller lever Ø19x5mm [Ⓛ]	5	0.065
KXAF3	Adjustable rubber Ø50x10mm [Ⓜ] roller lever	5	0.072
KXAF4	Adjustable offset rubber Ø50x10mm [Ⓜ] roller lever	5	0.081
KXAH1	Ceramic rod lever	5	0.056
KXAL1	Adjustable plastic rod lever	5	0.043
KXAL2	Adjustable stainless steel rod lever	5	0.051
KXAM1	Flexible wobble stick	5	0.032
KXAM2	Semirigid wobble stick	5	0.023

Ⓛ Ø19x5mm = Ø0.75"x0.2".
 Ⓜ Ø50x10mm = Ø1.97"x0.39".

General characteristics

The KXA... operating heads can be used as spare parts for the K series limit switches or coupled with the KXC... bodies to obtain complete limit switches in the required configurations.

The heads are made of metal and warrant sturdiness and operating reliability in all conditions.

The shape of the coupling section with the body of the K series switches permits to orient the head in any 45° angle position while the initial lever and rod position can be adjusted 360° at 15° angle positions.

The head fixing to the body is achieved by the innovative locking bayonet mechanism so there is no need of tools. Tightening torque for eventual operating head actuator fixing is 0.8Nm/7lb.in.

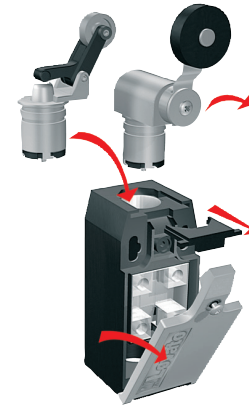

Cable glands and cable conduit



Order code	Description	Qty per pkg	Wt
		n°	[kg]
KXP01	M20 cable gland	50	0.009
KXP02	PG13.5 cable gland	50	0.009
KXP03	M20 rubber cable conduit	50	0.004

General characteristics

The cable glands are in plastic with either M20 or PG13.5 thread and provide to keep the cable in place and maintain the proper IP protection of the limit switch after installation.

Operational characteristics for cable gland

- Material: self-extinguishing polyamide
- IEC degree of protection: IP68
- Gland seal with cable diameter: 6...12mm/0.24...0.47".

Certifications and compliance

Certifications obtained: EAC.
 Compliant with standards: EN/BS 50262, UL508.



Order code	Contacts 1NO+1NC	Head material	Cable length ⊕	Qty per pkg	Wt [kg]
------------	---------------------	------------------	----------------------	-------------------	------------

TOP PUSH ROD PLUNGER.

KPA1S11	Snap action⊕	Metal	2	1	0.286
KPA1L11	Slow action⊕	Metal	2	1	0.286
KPA2S11⊕	Snap action⊕	Metal	2	1	0.302
KPA2L11⊕	Slow action⊕	Metal	2	1	0.302

TOP ROLLER PUSH PLUNGER.

KPB1S11	Snap action⊕	Plastic	2	1	0.290
KPB1L11	Slow action⊕	Plastic	2	1	0.290
KPB2S11	Snap action⊕	Metal	2	1	0.290
KPB2L11	Slow action⊕	Metal	2	1	0.290
KPB3S11⊕	Snap action⊕	Plastic	2	1	0.288
KPB3L11⊕	Slow action⊕	Plastic	2	1	0.288
KPB4S11⊕	Snap action⊕	Metal	2	1	0.296
KPB4L11⊕	Slow action⊕	Metal	2	1	0.296

M12 HEAD TOP ROLLER PUSH PLUNGER.

KPB5S11	Snap action⊕	Plastic	2	1	0.308
KPB5L11	Slow action⊕	Plastic	2	1	0.308
KPB6S11	Snap action⊕	Metal	2	1	0.310
KPB6L11	Slow action⊕	Metal	2	1	0.310
KPB7S11⊕	Snap action⊕	Plastic	2	1	0.310
KPB7L11⊕	Slow action⊕	Plastic	2	1	0.310
KPB8S11⊕	Snap action⊕	Metal	2	1	0.310
KPB8L11⊕	Slow action⊕	Metal	2	1	0.310

ROLLER LEVER PLUNGER.

KPE1S11	Snap action⊕	Plastic	2	1	0.336
KPE1L11	Slow action⊕	Plastic	2	1	0.336
KPE2S11	Snap action⊕	Metal	2	1	0.336
KPE2L11	Slow action⊕	Metal	2	1	0.336

ADJUSTABLE ROLLER LEVER.

KPF1S11	Snap action⊕	Plastic	2	1	0.344
KPF1L11	Slow action⊕	Plastic	2	1	0.344

ADJUSTABLE ROD LEVER.

KPL2S11	Snap action⊕	Metal	2	1	0.342
KPL2L11	Slow action⊕	Metal	2	1	0.342

OMNIDIRECTIONAL WOBBLE STICK.

KPM2S11	Snap action⊕	Metal	2	1	0.298
----------------	--------------	-------	---	---	-------

- ⊕ Direct (positive) opening action ⊖; safety function according to IEC/EN/BS 60947-5-1.
- ⊕ For prewired switches with 1m long cable only, add suffix 010 at the end of the order code.
Example: KPA1S11010 for prewired switch, top push metal rod plunger, with 1NO+1NC snap action contacts and 1m long cable.
- ⊕ M12 head fixing.
- ⊕ Roller operation perpendicular to switch body.

Operational characteristics

- 2 meters long cable ⊕ (5 core, each 0.75mm²/18 AWG)
- Maximum operating rate: 3600 cycles/h
- Mechanical life: >10 million cycles
- IEC conventional thermal current I_{th}: 10A
- conductivity: 10mA 5V
- UL/CSA and IEC/EN/BS 60947-5-1 designation: B300 R300
- IEC rated insulation voltage U_i: 400VAC
- IEC rated impulse withstand voltage U_{imp}: 4kV
- Class I insulation
- Contact resistance: <25mΩ
- Body housing: aluminium and zinc alloy
- Operating force/torque:
 - KPA types: 15N / 3.4lb
 - KPB types: 10N / 2.2lb
 - KPE, KPF and KPL types: 0.08Nm / 0.7lb.in
 - KPM types: 0.1Nm / 0.9lb.in
- Tightening torque for switch fixing: 2.5Nm / 22.1lb.in for body housing fixing possible: 0.8Nm / 7lb.in
- Ambient conditions:
 - Operating temperature: -25...+70°C
 - Storage temperature: -40...+70°C
 - Pollution degree: 3
 - IEC degree of protection: IP67 for body housing.

Certifications and compliance

Certifications obtained: UL Listed for USA and Canada (cULus - File E93601), as Auxiliary Devices - Limit switches; EAC.
Compliant with standards: IEC/EN/BS 60947-1, IEC/EN/BS 60947-5-1, UL508, CSA C22.2 n° 14.

- ▶ Forward travel of snap action contacts
- ◀ Return travel of snap action contacts
- open
- closed

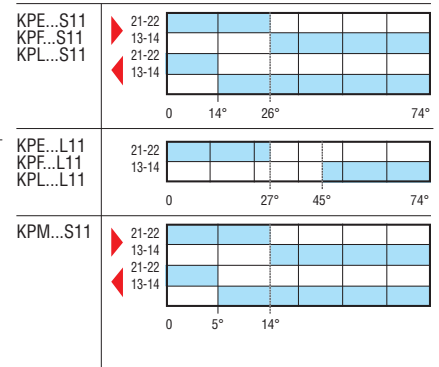
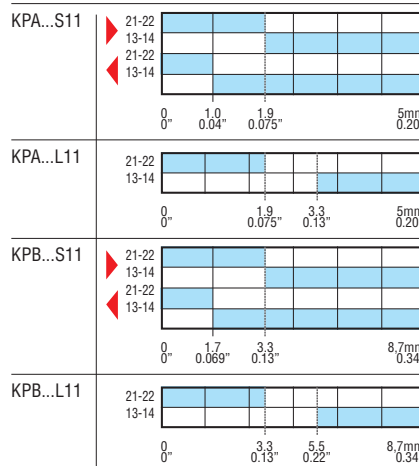

Top push rod plunger



PLN...A...

Order code	Contacts	Degree of protection	Qty per pkg	Wt [kg]
			n°	
PLNA1A	1NC \odot	IP40	1	0.240
PLNA1AW		IP65	1	0.240
PLNA2A	2NC \odot	IP40	1	0.240
PLNA2AW		IP65	1	0.240
PLNC1A	1NO	IP40	1	0.240
PLNC1AW		IP65	1	0.240
PLNC2A	2NO	IP40	1	0.240
PLNC2AW		IP65	1	0.240
PLNU1A	1NO+1NC	IP40	1	0.240
PLNU1AW		IP65	1	0.240

\odot Direct (positive) opening action \ominus ; safety function according to IEC/EN/BS 60947-5-1.

Top roller push plunger



PLN...R...

Order code	Contacts	Degree of protection	Qty per pkg	Wt [kg]
			n°	
PLNA1R	1NC \odot	IP40	1	0.230
PLNA1RW		IP65	1	0.230
PLNA2R	2NC \odot	IP40	1	0.230
PLNA2RW		IP65	1	0.230
PLNC1R	1NO	IP40	1	0.230
PLNC1RW		IP65	1	0.230
PLNC2R	2NO	IP40	1	0.230
PLNC2RW		IP65	1	0.230
PLNU1R	1NO+1NC	IP40	1	0.230
PLNU1RW		IP65	1	0.230

\odot Direct (positive) opening action \ominus ; safety function according to IEC/EN/BS 60947-5-1.

Roller centre push lever



PLN...H

Order code	Contacts	Degree of protection	Qty per pkg	Wt [kg]
			n°	
PLNA1H	1NC \odot	IP40	1	0.270
PLNA1HW		IP65	1	0.270
PLNA2H	2NC \odot	IP40	1	0.270
PLNA2HW		IP65	1	0.270
PLNU1H	1NO+1NC	IP40	1	0.270
PLNU1HW		IP65	1	0.270

With offset roller.

PLNA1HSB	1NC \odot	IP40	1	0.290
PLNA1HSBW		IP65	1	0.290
PLNA2HSB	2NC \odot	IP40	1	0.290
PLNA2HSBW		IP65	1	0.290
PLNU1HSB	1NO+1NC	IP40	1	0.290
PLNU1HSBW		IP65	1	0.290

\odot Direct (positive) opening action \ominus ; safety function according to IEC/EN/BS 60947-5-1.



PLN...HSBW

Type	Travel [mm (in)]	Legend
PLNA1A... PLNA1R...	1.5 (0.06") to 11.5 (0.45") 11-12 [mm (in)]	open (white), closed (blue)
PLNA1H... PLNA1HSB...	2.4 (0.09") to 20 (0.79") 11-12 [mm (in)]	
PLNA2A... PLNA2R...	1.5 (0.06") to 6.5 (0.25") 11-12, 21-22 [mm (in)]	
PLNA2H... PLNA2HSB...	2.4 (0.09") to 11.5 (0.45") 11-12, 21-22 [mm (in)]	
PLNC1A... PLNC1R...	2.2 (0.09") to 11.5 (0.45") 13-14 [mm (in)]	
PLNC2A... PLNC2R...	4.2 (0.16") to 6.4 (0.25") 13-14, 23-24 [mm (in)]	
PLNU1A... PLNU1R...	1.5 (0.06") to 11.5 (0.45") 21-22, 13-14 [mm (in)]	
PLNU1H... PLNU1HSB...	2.4 (0.09") to 20 (0.79") 21-22, 13-14 [mm (in)]	10.4 (0.41") [mm (in)]

General characteristics

The PL types are for general purpose use. The extensive range of models with numerous actuators and multiple contact configurations is the optimal solution to the diverse installation requirements.

Overall simple design, oversize contacts and choice materials ensure durable and safe operation. The metal alloy housing and resistant thermoplastic actuators warrant reliable heavy-duty features for any sort of operating conditions.

The PL series limit switches are available with IEC IP40 or IP65 degree of protection; this characteristic is ensured by the use of appropriate sealing gasket.

The IEC IP65 version is easily identified by the "W" suffix of its order code and can be used in adverse ambient conditions.

Operational characteristics

- Maximum operating rate: 3600 cycles/h
- Mechanical life: >10 million cycles
- IEC utilisation category:
 - DC13 duty: 10A 24V
 - AC15 duty: 5A 250V, 3A 400V
- IEC conventional thermal current Ith: 10A
- IEC rated insulation voltage Ui: 400VAC
- Contact resistance: <10m Ω
- Short-circuit backup protection: 10A gG/SC quick fuse
- Housing cable entry: PG11 (PLN...W types only complete with cable gland)
- Cable connection: screw terminal with clamp suitable for cables up to 2.5mm² / 14 AWG
- Tightening torque:
 - Switch fixing: 2.5Nm / 22.1lb.in
 - Contact terminals: 0.8Nm / 7lb.in
 - Body lid screw fixing: 0.8Nm / 7lb.in
- Ambient conditions:
 - Operating temperature: -25...+70°C
 - Storage temperature: -40...+70°C
 - Pollution degree: 3
 - IEC degree of protection: IP40 / IP65 (see table indications).

Certifications and compliance

Certifications obtained: EAC.
Compliant with standards: IEC/EN/BS 60947-1, IEC/EN/BS 60947-5-1, EN/BS 81-1.

Latch and manual release



PLNA1RAG

Order code	Contacts	Degree of protection	Qty pre pkg	Wt
		IEC	n°	[kg]

Top roller push plunger.

PLNA1RAG	1NC ①	IP40	1	0.220
PLNA1RAGW	1NC ①	IP65	1	0.230

① Direct (positive) opening action ⊖; safety function according to IEC/EN/BS 60947-5-1.

Manual reload and magnetic release



PLA1AM

Order code	Contacts	Degree of protection	Qty pre pkg	Wt
		IEC	n°	[kg]

Top push rod plunger.

PLA1AM	1NC ①	IP40	1	0.245
PLA1AMW	1NC ①	IP65	1	0.250

Top roller push plunger.

PLA1RM	1NC ①	IP40	1	0.250
PLA1RMW	1NC ①	IP65	1	0.260

① Direct (positive) opening action ⊖; safety function according to IEC/EN/BS 60947-5-1.



PLA1RMW

Bi-directional



PLN978

Order code	Contacts	Degree of protection	Qty pre pkg	Wt
		IEC	n°	[kg]

Rod plunger.

PLN978	2NC ① independent	IP65	1	0.265
---------------	----------------------	------	---	-------

① Direct (positive) opening action ⊖; safety function according to IEC/EN/BS 60947-5-1.

Type	Travel [mm (in)] (The arrows indicate the direction of operation)	open closed
PLNA1RAG PLNA1RAGW		
PLA1AM PLA1AMW PLA1RM PLA1RMW		
PLN978		

General characteristics

The PL limit switches were initially made specifically for hoisting or lifting duty and then used in other diverse applications. The type with latch and manual release as well as the one with manual reload and magnetic release are designed so the switch remains opened after the switching of the NC contact. In the first instance, the contact closing is made by pushing the release button. In the second case, the reloading is obtained by pushing the shaft end or else pulling it from the top for the IP65 types.

The limit switches with dual operation can be replaced by two standard switches, for the stop control of moving mechanisms with two directions of running (e.g. automatic doors). It is equipped with two opposed operating mechanisms and one NC contact for each mechanism (i.e. 2NC).

The simple constructive design, oversize contacts and careful material combinations warrant safe and constant operation. The metal-alloy housing and the thermoplastic mechanism material of first-rate mechanical features assure reliability and durability with any type of operating condition.

Operational characteristics

- Maximum operating rate: 3600 cycles/h
- Mechanical life: >10 million cycles
- IEC utilisation category:
 - DC13 duty: 10A 24V
 - AC15 duty: 5A 250V, 3A 400V
- IEC conventional thermal current I_{th}: 10A
- IEC rated insulation voltage: 400VAC
- Contact resistance: <10mΩ
- Short-circuit backup protection: 10A gG/SC quick fuse
- Housing cable entry: PG11 (PL...W and PLN978 types only complete with cable gland)
- Cable connection: screw terminal with clamp suitable for cables up to 2.5mm² / 14 AWG
- Tightening torque:
 - Switch fixing: 2.5Nm / 22.1lb.in
 - Contact terminals: 0.8Nm / 7lb.in
 - Body lid screw fixing: 0.8Nm / 7lb.in
- Ambient conditions:
 - Operating temperature: -25...+70°C
 - Storage temperature: -40...+70°C
 - Pollution degree: 3
 - IEC degree of protection: IP40 / IP65 (see table indications).

Certifications and compliance

Certifications obtained: EAC.
Compliant with standards: IEC/EN/BS 60947-5-1, IEC/EN/BS 60204-1, EN/BS 81-1.

10 Limit, micro and foot switches

Rope-pull lever limit switches for normal stopping

Dimensions to EN/BS 50047



RS113... - RS213... - RS313...

Order code	Contacts	Ring material	Qty per pkg	Wt
			n°	[kg]
Without reset button.				
RS11310	1NO+1NC Snap action	Steel	1	0.090
RS21310	1NO+1NC Slow action	Steel	1	0.090
RS31310	2NO Slow action	Steel	1	0.090

Accessories and spare parts



P33032



P33033



P33034



P33035



P33036

Order code	Description	Qty per pkg	Wt
		n°	[kg]
Accessories.			
P33032	Rope terminal clamp, Ø5mm	10	0.023
P33033	Rope eye, Ø5mm	10	0.007
P33034	Turnbuckle M6x60	10	0.061
P33035	Eye bolt M8	10	0.030
P33036	Steel rope, Ø5mm	100[m]	4.900

① The P33036 rope is sold in 100m/109.4yd roll; Ø5mm = Ø0.2".

Type	Forward travel of snap action contacts	Return travel of snap action contacts
	open	closed
RS113...		
RS213...		
RS313...		

General characteristics

The RS series limit switches are designed and manufactured according to European standards for dimensions and operating characteristics.

The double-insulated housing of the limit switch is made of glass-reinforced self-extinguishing polyamide resin to protect internal circuits against shocks or impacts and in industrial environments, against accidental ingress of tools and accidental contact.

The contacts are dimensioned to ensure self cleaning of the silver-alloy contact surfaces.

Operational characteristics

- Maximum operating rate: 3600 cycles/h for RS...13
- Switching speed: 0.5...1.5m/s
- Mechanical life: >10 million cycles
- IEC utilisation category:
 - DC13 duty: 1.5A 24V
 - AC15 duty: 6A 250V
- IEC conventional thermal current I_{th}: 10A
- IEC rated insulation voltage U_i: 250VAC
- Contact resistance: <10mΩ
- Short-circuit backup protection: 10A gG/SC quick fuse
- Operating force: 25N/5.6lb
- Cable entry: PG11 (RS...13)
- Cable connection: self-releasing screw terminal
- Tightening torque:
 - Switch fixing: 2.5Nm / 22.1lb.in
 - Contact terminals: 0.8Nm / 7lb.in
 - Body lid screw fixing: 0.8Nm / 7lb.in
- Conductor section: 1 or 2 2.5mm² max / 16-14 AWG
- Ambient conditions:
 - Operating temperature: -25...+70°C
 - Storage temperature: -40...+70°C
 - Pollution degree: 3
 - IEC degree of protection: IP65 (RS...13).

Certifications and compliance

Certifications obtained: UL Listed for USA and Canada (cULus - File E93601), as Auxiliary Devices - Limit switches; EAC.

Compliant with standards: IEC/EN/BS 60947-1, IEC/EN/BS 60947-5-1, IEC/EN/BS 60204-1, EN/BS 81-1, EN/BS 50041, UL508, CSA C22.2 n° 14.



PLN...AT...W



P2L...

Accessories and spare parts



P33032



P33033



P33034



P33035



P33036

Order code	Contacts	Degree of protection	Operating force	Qty per pkg	Wt
		IEC	[N] / [lb]	n°	[kg]
Without reset button.					
PLNU1AT	1NO+1NC	IP40	10 / 2.2	1	0.240
PLNU1ATW	①	IP65	10 / 2.2	1	0.240
PLNU1AT25	1NO+1NC	IP40	25 / 5.6	1	0.240
PLNU1AT25W	①	IP65	25 / 5.6	1	0.240

① Direct (positive) opening action ⊖; safety function according to IEC/EN/BS 60947-5-1.

Order code	Contacts	Degree of protection	Operating force	Qty per pkg	Wt
		IEC	[N] / [lb]	n°	[kg]
Without reset button.					
P2L81311	1NO+1NC	IP65	40 / 9	1	0.459
P2L81312	①	IP65	120 / 27	1	0.459
P2L101311	2NO+2NC	IP65	40 / 9	1	0.459
P2L101312	①	IP65	120 / 27	1	0.459

① Direct (positive) opening action ⊖; safety function according to IEC/EN/BS 60947-5-1.

Order code	Description	Qty per pkg	Wt
		n°	[kg]
Accessories.			
P33032	Rope terminal clamp, Ø5mm	10	0.023
P33033	Rope eye, Ø5mm	10	0.007
P33034	Turnbuckle M6x60	10	0.061
P33035	Eye bolt M8	10	0.030
P33036	Steel rope, Ø5mm①	100[m]	4.900

① The P33036 rope is sold in 100m/109.4yd roll; Ø5mm = Ø0.2".

Type	Travel [mm (in)]	Legend
		□ open ■ closed
PLNU1AT...	1.5 11 0.06" 0.43" 13-14 21-22 6 [mm (in)] 0.24"	
P2L8...	11-12 21-22 0 [mm (in)] 10 0.39"	
P2L10...	31-32 41-42 13-14 23-24 0 [mm (in)] 10 0.39"	

General characteristics

The PLN and P2L types are limit switches for general use. The simple constructive design, oversize contacts and careful material combinations warrant safe and constant operation. The metal-alloy housing and the thermoplastic mechanism material of first-rate mechanical features assure reliability and durability with any type of operating condition.

Operational characteristics

- Maximum operating rate: 3600 cycles/h
- Mechanical life: >10 million cycles
- IEC utilisation category:
 - DC13 duty: 10A 24V
 - AC15 duty: 5A 250V; 3A 400V
- IEC conventional thermal current Ith: 10A for PLN types; 6A for P2L types
- IEC rated insulation voltage Ui: 400VAC
- Contact resistance: <10mΩ
- Short-circuit backup protection: 10A gG/SC quick fuse
- Cable entry: PG11 (PLN...W and P2L types only complete with cable gland)
- Cable connection: self-releasing screw terminal suitable for cables up to 2.5mm² / 14 AWG
- Tightening torque for switch fixing: 2.5Nm/2.21lb.in
- Ambient conditions:
 - Operating temperature: -25...+70°C
 - Storage temperature: -40...+70°C
 - Pollution degree: 3
 - IEC degree of protection: IP40 / IP65 (see order code table indications).

Certifications and compliance

Certifications obtained: EAC.
Compliant with standards: IEC/EN/BS 60947-1, IEC/EN/BS 60947-5-1, EN/BS 81-1.

10 Limit, micro and foot switches

Plastic micro switches.
Accessories



KSA1...

KSA2...



KSA3...

KSA4...

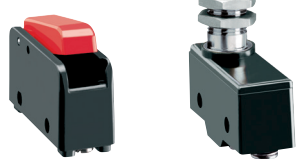

KSA9...

KSB1...

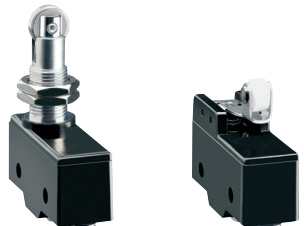

KSB2...

KSC1...

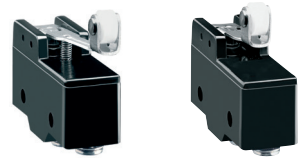

KSC2...

KSC3...

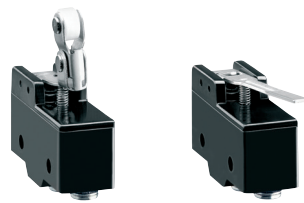

KSC9...

KSL1...

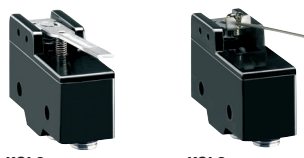

KSL2...

KSL3...

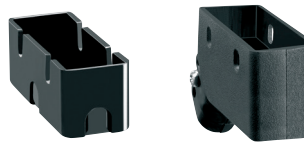

KSSC01

KSSCB2

Order code	Contacts	Terminals	Qty per pkg	Wt
			n°	[kg]
TOP PUSH ROD. METAL PLUNGER. Pin.				
KSA1S	1NO/NC	Solder	10	0.027
KSA1V	1NO/NC	Screw	10	0.027
KSA1F	1NO/NC	Faston	10	0.029
TOP PUSH ROD. METAL PLUNGER. High rod plunger.				
KSA2S	1NO/NC	Solder	10	0.029
KSA2V	1NO/NC	Screw	10	0.029
KSA2F	1NO/NC	Faston	10	0.031
TOP PUSH ROD. METAL PLUNGER. Low rod plunger.				
KSA3S	1NO/NC	Solder	10	0.029
KSA3V	1NO/NC	Screw	10	0.028
KSA3F	1NO/NC	Faston	10	0.030
TOP PUSH ROD. METAL PLUNGER. M12 fixing head.				
KSA4S	1NO/NC	Solder	10	0.048
KSA4V	1NO/NC	Screw	10	0.047
KSA4F	1NO/NC	Faston	10	0.049
PUSH BUTTON.				
KSA9S	1NO/NC	Solder	10	0.029
KSA9V	1NO/NC	Screw	10	0.028
KSA9F	1NO/NC	Faston	10	0.030
TOP ROLLER PUSH PLUNGER. M12 fixing head.				
KSB1S	1NO/NC	Solder	10	0.061
KSB1V	1NO/NC	Screw	10	0.060
KSB1F	1NO/NC	Faston	10	0.062
TOP ROLLER PUSH PLUNGER. M12 fixing head, 90° roller.				
KSB2S	1NO/NC	Solder	10	0.061
KSB2V	1NO/NC	Screw	10	0.060
KSB2F	1NO/NC	Faston	10	0.062
ROLLER CENTRE PUSH LEVER. 26.6mm/1.05" long lever.				
KSC1S	1NO/NC	Solder	10	0.032
KSC1V	1NO/NC	Screw	10	0.031
KSC1F	1NO/NC	Faston	10	0.033
ROLLER CENTRE PUSH LEVER. 48.5mm/1.91" long lever.				
KSC2S	1NO/NC	Solder	10	0.032
KSC2V	1NO/NC	Screw	10	0.031
KSC2F	1NO/NC	Faston	10	0.033
ROLLER CENTRE PUSH LEVER. 37mm/1.45" long lever.				
KSC3S	1NO/NC	Solder	10	0.032
KSC3V	1NO/NC	Screw	10	0.031
KSC3F	1NO/NC	Faston	10	0.033
ROLLER CENTRE PUSH LEVER. One-way roller lever.				
KSC9S	1NO/NC	Solder	10	0.034
KSC9V	1NO/NC	Screw	10	0.033
KSC9F	1NO/NC	Faston	10	0.035
METAL LEVER. 63mm/2.48" long flat lever.				
KSL1S	1NO/NC	Solder	10	0.032
KSL1V	1NO/NC	Screw	10	0.031
KSL1F	1NO/NC	Faston	10	0.033
METAL LEVER. 54mm/2.13" long flat lever.				
KSL2S	1NO/NC	Solder	10	0.032
KSL2V	1NO/NC	Screw	10	0.031
KSL2F	1NO/NC	Faston	10	0.033
METAL LEVER. 168.3mm/6.63" long flat cylindrical lever.				
KSL3S	1NO/NC	Solder	10	0.032
KSL3V	1NO/NC	Screw	10	0.031
KSL3F	1NO/NC	Faston	10	0.033
ACCESSORIES. ❶				
KSSC01	Terminal shroud		10	0.006
KSSCB2	Terminal shroud with conduit		10	0.014

❶ Suitable only for KS...V.

Operational characteristics

- Maximum operating rate: 240 cycles/min
- Switching speed: 0.01...1m/s
- Operating speed: 0.05...1m/s
- Electrical life: 500,000 cycles
- Mechanical life: 20 million cycles
- IEC conventional thermal current Ith: 15A
- UL/CSA and IEC/EN/BS 60947-5-1 designation: A600 P300
- Conductivity: 10mA 5V
- IEC rating: AC15 240VAC 3A
- IEC rated insulation voltage Ui: 250VAC
- Contact resistance: <15mΩ
- Body housing: polymer thermoplastic
- Operating force:
 - KSA1-KSA4 and KSB types: 2.5N/9oz
 - KSA9 and KSC3 types: 1.5N/4.4oz
 - KSL types: 1N/3.6oz
 - KSC2 and KSL2: 1.3N/4.7oz
 - KSC9 types: 1.7N/6.1oz
 - KSL1 types: 6.4N/23oz
 - KSL3 types: 0.1N/0.36oz
- Tightening torque:
 - For M12 head fixing: 4.9...6.9Nm/43...61lb.in
 - For side screws: 0.6...1Nm/5.3...8.8lb.in
 - For terminal screws: 0.7...1Nm/6.2...8.8lb.in
- Ambient conditions:
 - Operating temperature: -25...+70°C
 - Storage temperature: -40...+70°C
 - Pollution degree: 3
 - IEC degree of protection: IP00 or IP20 with terminal shroud.

Certifications and compliance

Certifications obtained: UL Recognized for USA and Canada (File E172189) as Industrial Control Switches - Component; products having this type of marking are intended for use as components of complete workshop - assembled equipment; EAC.
Compliance with standards: IEC/EN/BS 60947-1, IEC/EN/BS 60947-5-1, IEC/EN/BS 61058-1, UL508, CSA C22.2 n° 14.



KG200 ...
KG220 ...



KR200 ...



KG110 ...



KR210 ...
KR211 ...

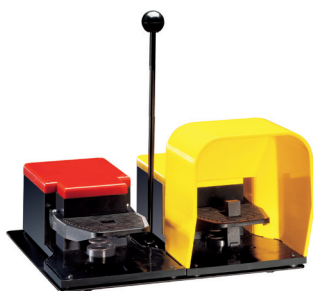

KGD003 - KGD004

- ① Direct (positive) opening action \ominus ; safety function according to IEC/EN/BS 60947-5-1.
- ② Consult Technical support for information; see contact details on inside cover.
- ③ A possible second contact block can be fitted; blocks with only 2 contacts in total can be used. See accessories below.

Accessories



KXP...



KXP03

- ④ A possible second contact block can be fitted on the left-hand pedal; blocks with only 2 contacts in total can be used. See accessories below and contact blocks on page 10-14.

Order code Plastic body	Metal body	Model	Contacts	Qty per pkg	Wt
				n°	[kg]

ONE PEDAL FOOT SWITCHES. With free actuation.

KG100S11 ③	KR100S11 ③	Open	1NO+1NC Snap action ①	1	②
KG100L11 ③	KR100L11 ③	Open	1NO+1NC Snap action ①	1	②
KG200S11 ③	KR200S11 ③	With cover	1NO+1NC Snap action ①	1	②
KG200L11 ③	KR200L11 ③	With cover	1NO+1NC Snap action ①	1	②

With safety lever.

KG110S11 ③	KR110S11 ③	Open	1NO+1NC Slow action ①	1	②
KG110L11 ③	KR110L11 ③	Open	1NO+1NC Slow action ①	1	②
KG210S11 ③	KR210S11 ③	With cover	1NO+1NC Snap action ①	1	②
KG210S11 ③	KR210S11 ③	With cover	1NO+1NC Slow action ①	1	②
KG210S22 ③	KR210S22 ③	With cover	2NO+2NC Slow action ①	1	②

With pedal actuator lock.

KG120S11 ③	KR120S11 ③	Open	1NO+1NC Snap action ①	1	②
KG120L11 ③	KR120L11 ③	Open	1NO+1NC Snap action ①	1	②
KG220S11 ③	KR220S11 ③	With cover	1NO+1NC Snap action ①	1	②
KG220L11 ③	KR220L11 ③	With cover	1NO+1NC Snap action ①	1	②

With two-stage safety lever.

KG211S22 ③	KR211S22 ③	With cover	2NO+2NC 2-stage snap action ①	1	②
---------------	---------------	---------------	-------------------------------------	---	---

Order code Plastic body	Metal body	Model	Contacts (for each pedal)	Qty per pkg	Wt
				n°	[kg]

TWO PEDAL FOOT SWITCHES. With safety lever on both pedals.

KGD001 ③	KRD001 ③	Both w/cover	1NO+1NC Snap action ①	1	②
KGD002 ③	KRD002 ③	Both w/cover	2NO+2NC Snap action ①	1	②

Left pedal with free actuation and right pedal with safety lever.

KGD003 ③	KRD003 ③	Left open	1NO+1NC Snap action ①	1	②
		Right w/cover			
KGD004 ③	KRD004 ③	Left open	1NO+1NC Snap action ①	1	②
		Right w/cover			

General characteristics

The KG... and KR... foot switches are used to control machinery and other equipment, leaving the operator's hands free to do other functions. The sturdiness of the metal and plastic body and the wide range of the available versions provide the proper solution for each control need.

Main features are:

- Thermoplastic or metal version.
The plastic or metal body gives adequate robustness to the foot switch, for installation in all ambient and application conditions.
- Versions complete with or without pedal protection cover. The cover assures protection against accidental foot switch operation, due to sudden tool or heavy material dropping or other shock or vibration. The type without cover, open version, is instead immediately accessible and is preferred when the most important pedal operation is to stop a machine.
- Versions with safety lever.
The safety mechanism prevents unintentional foot switch activation and excludes the pedal pressing if the operator's foot is not completely in place.
- Stable pedal base.
The foot switch is equipped with rubber feet and metal-reinforced base for a firm and non-sliding position and a more reliable and safe activation.

Operational characteristics

- Mechanical life: >10 million cycles
- Conventional thermal current Ith: 10A
- Designation to IEC/EN/BS 60947-5-1:
 - A600 Q600 for KG types
 - A300 Q300 for KR types
- Tightening torque for contacts: 1Nm/8.8lb.in
- Rated insulation voltage Ui:
 - 690VAC for KG types
 - 440VAC for KR types
- Rated impulse withstand voltage Uimp:
 - 6kV for KG types
 - 4kV for KR types
- Class II insulation (KG types only)
- Contact resistance: <10mΩ
- Short-circuit backup protection: 10A gG fuse
- Cable connection: self-releasing screw terminal
- Housing:
 - KG types: self-extinguishing double-insulation polymer thermoplastic
 - KR types: aluminium-zinc alloy
- Cable entry: M20
- Ambient conditions:
 - Operating temperature: -25...+70°C
 - Storage temperature: -40...+70°C
 - Pollution degree: 3
- IEC degree of protection:
 - IP20 for terminals
 - IP54 for body housing
 - IP65 available on request (add the letter S at the end of the order code. E.g. KG100S11S).

Certifications and compliance

Certifications obtained: cURus for contacts only and EAC for foot switches.

Compliant with standards: IEC/EN/BS 60947-1, IEC/EN/BS 60947-5-1, IEC/EN/BS 60204-1, IEC/EN/BS 60447.

General characteristics

The cable glands are in plastic with either M20 or PG13.5 thread and provide to keep the cable in place and maintain the proper IP protection of the switch after installation.

Operational characteristics for cable gland

- Material: self-extinguishing polyamide
- IEC degree of protection: IP68
- Gland seal with cable diameter: 6...12mm/0.24"...0.47"

Certifications and compliance

Certifications obtained: EAC.
Compliant with standards: EN/BS 50262, UL508.

Order code	Description	Qty per pkg	Wt
		n°	[kg]

Accessories.

KGX01	Kit of elements to activate 2 nd contact block ④	10	0.039
KGX02	Contact block mounting bracket	10	0.022

Cable glands and cable conduit.

KXP01	M20 cable gland	50	0.009
KXP02	PG13.5 cable gland	50	0.009
KXP03	M20 rubber cable conduit	50	0.004

LIMIT SWITCHES K SERIES

**KBA1...
KMA1...**

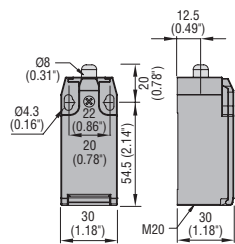

**KCA1
KNA1**

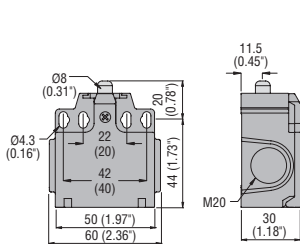

**KBB1... - KBB2...
KMB1... - KMB2...**

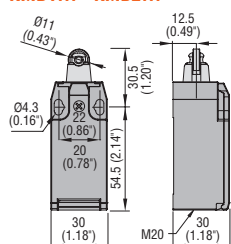

**KCB1... - KCB2...
KNB1... - KNB2...**

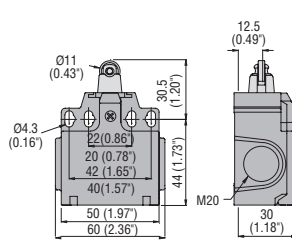

**KBC1... - KBC2...
KMC1... - KMC2...**

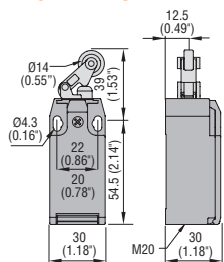

**KCC1... - KCC2...
KNC1... - KNC2...**

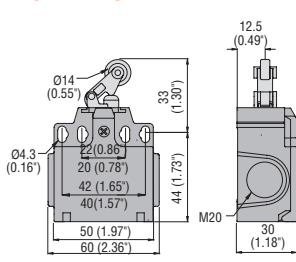

**KBD1... - KBD2...
KMD1... - KMD2...**

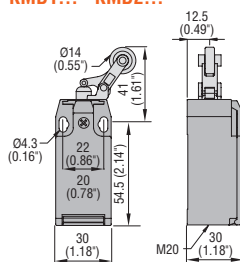

**KCD1... - KCD2...
KND1... - KND2...**

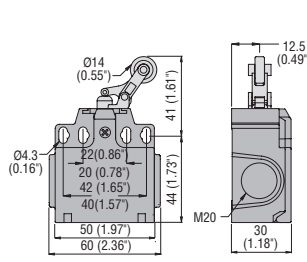

**KBE1... - KBE2...
KME1... - KME2...**

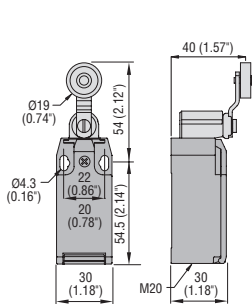

**KCE1... - KCE2...
KNE1... - KNE2...**

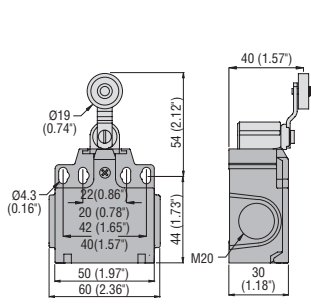

**KBE3...
KME3...**

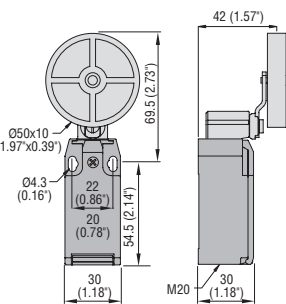

**KCE3...
KNE3...**

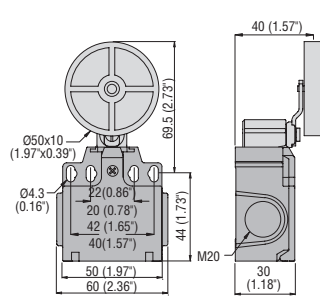

**KBF1... - KBF2...
KMF1... - KMF2...**

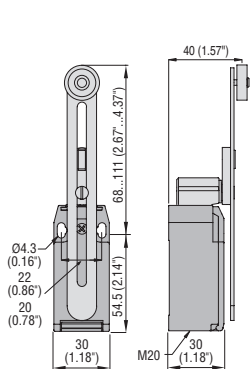

**KCF1... - KCF2...
KNF1... - KNF2...**

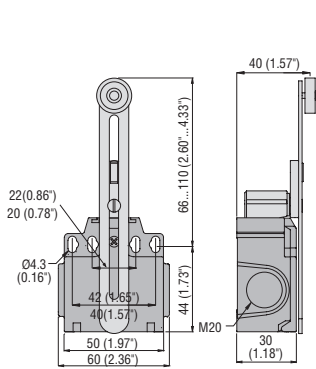

**KBF3...
KMF3...**

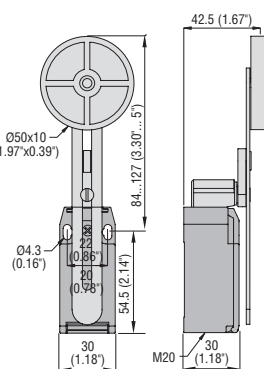

**KCF3...
KNF3...**

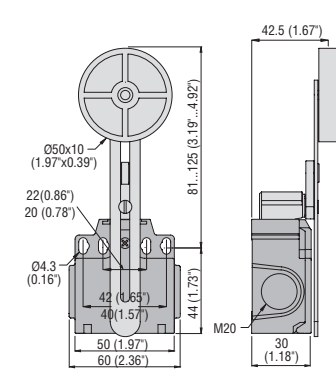

**KBF4...
KMF4...**

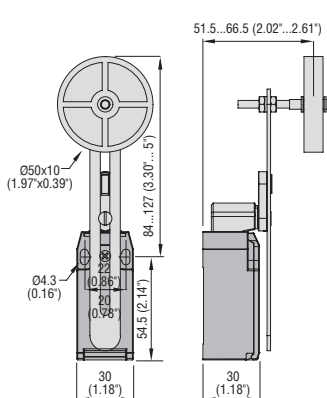

**KCF4...
KNF4...**

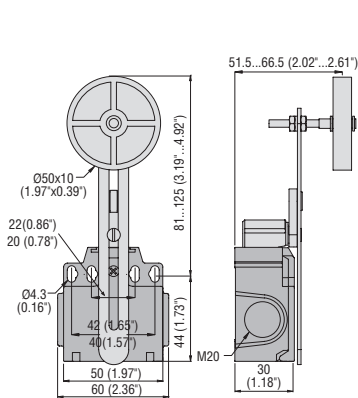

**KBH1...
KMH1...**

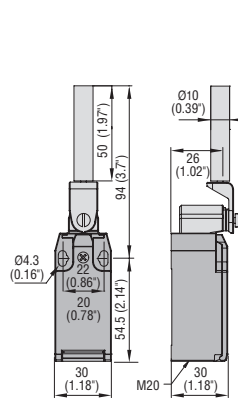

**KCH1...
KNH1...**

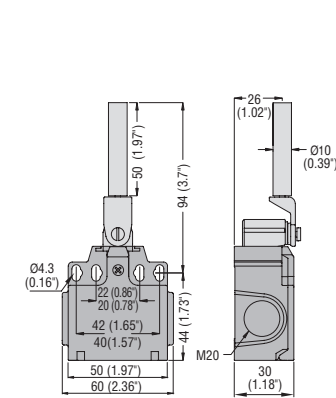

LIMIT SWITCHES K SERIES

KBL1... - KBL2...
KML1... - KML2...

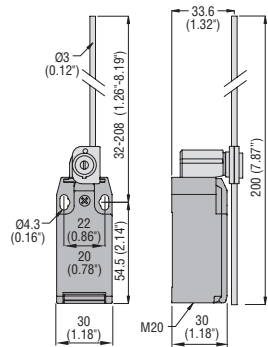

KCL1... - KCL2...
KNL1... - KNL2...

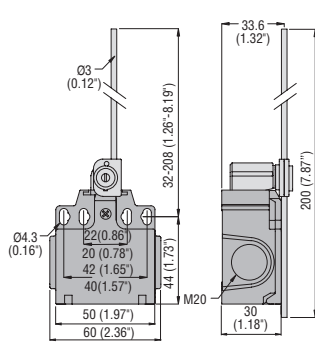

KBM1... - KBM2...
KMM1... - KMM2...

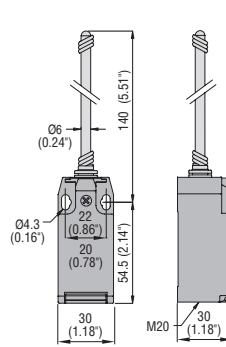

KCM1... - KCM2...
KNM1... - KNM2...

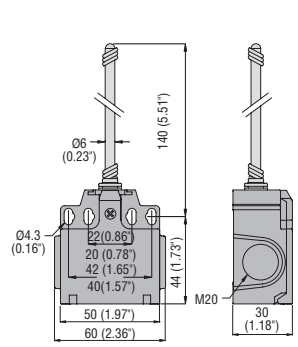

Cable glands

KXP01

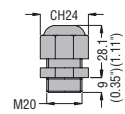

CH = Spanner/Wrench

KXP02

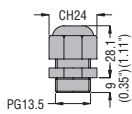

CH = Spanner/Wrench

Cable conduit

KXP03

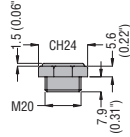

CH = Spanner/Wrench

PREWIRED METAL LIMIT SWITCHES

KPA1...

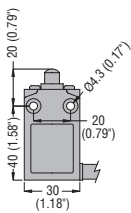

KPA2...

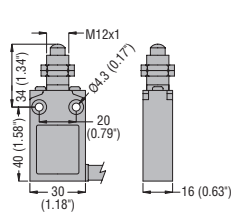

KPB1... - KPB2...

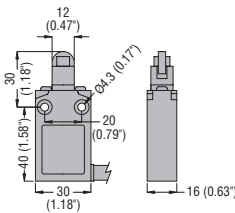

KPB3... - KPB4...

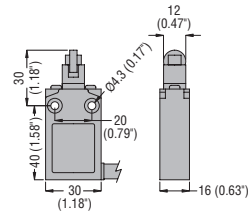

KPB5... - KPB6...

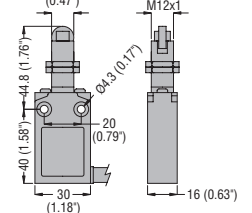

KPB7... - KPB8...

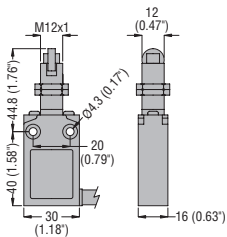

KPE1... - KPE2...

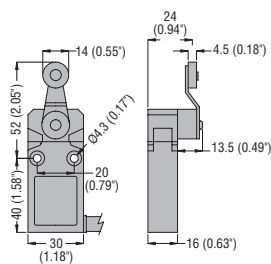

KPF1...

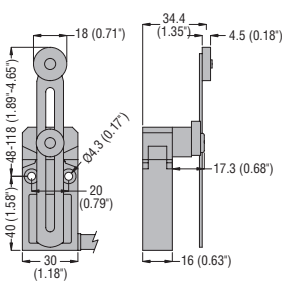

KPL2...

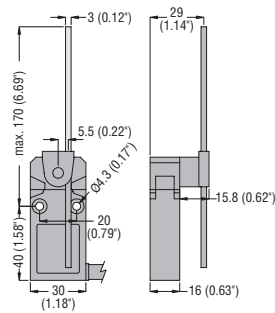

KPM2...

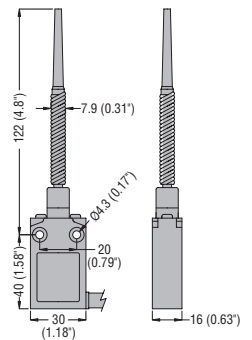

METAL LIMIT SWITCHES, PL SERIES

PLN...A

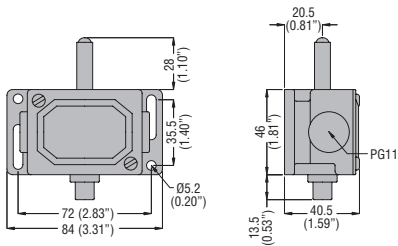

PLN...AW

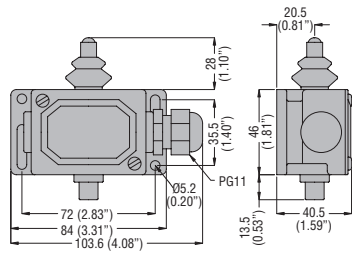

PLN...R

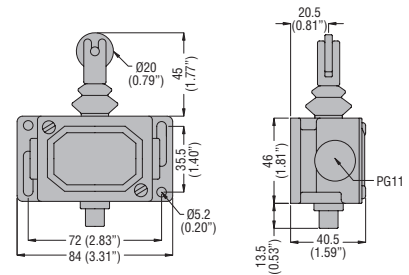

PLN...RW

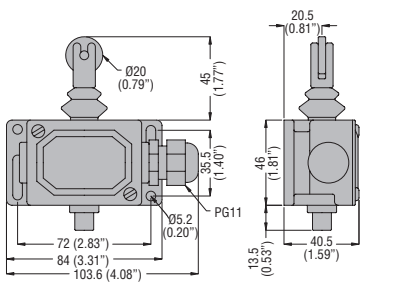

PLN...H

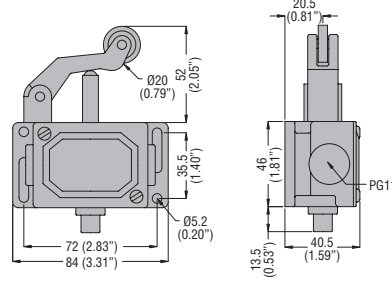

PLN...HW

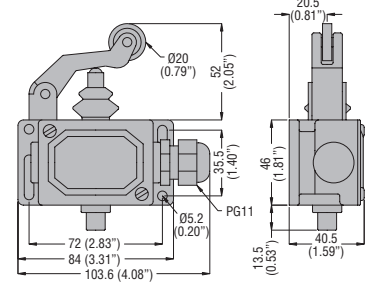

PLN...HSB

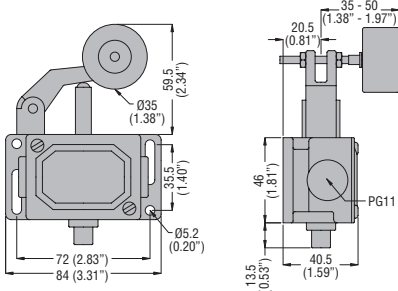

PLN...HSBW

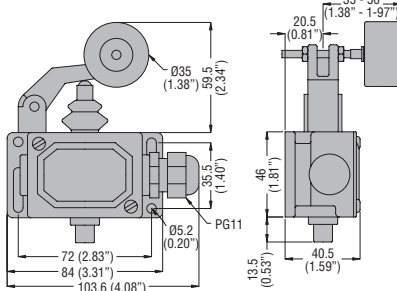

PLNA1RAG

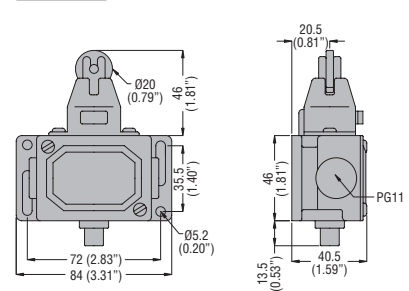

PLNA1RAGW

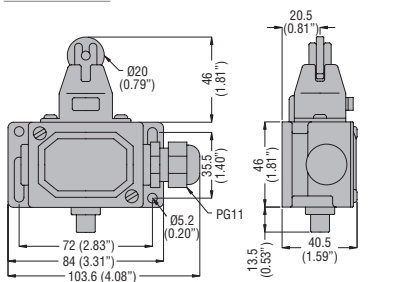

PLNA1AM

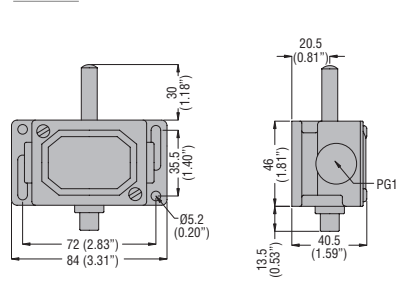

PLA1AMW

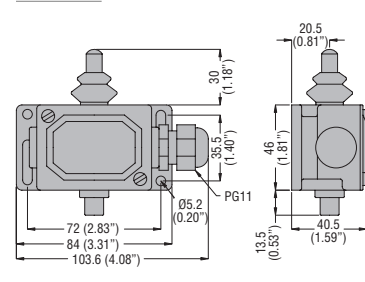

PLA1RM

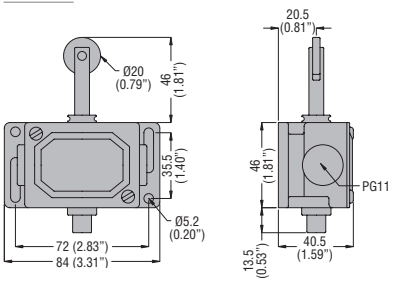

PLA1RMW

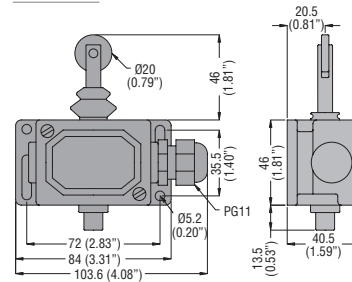

PLN978

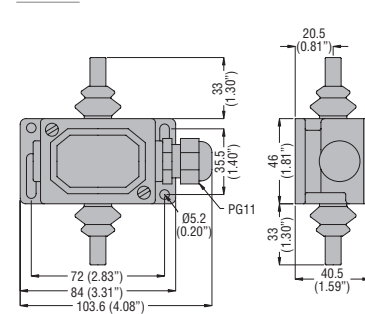

ROPE-PULL LEVER LIMIT SWITCHES FOR NORMAL STOPPING

RS113... - RS313...

PLN...AT

PLN...ATW

P2L...

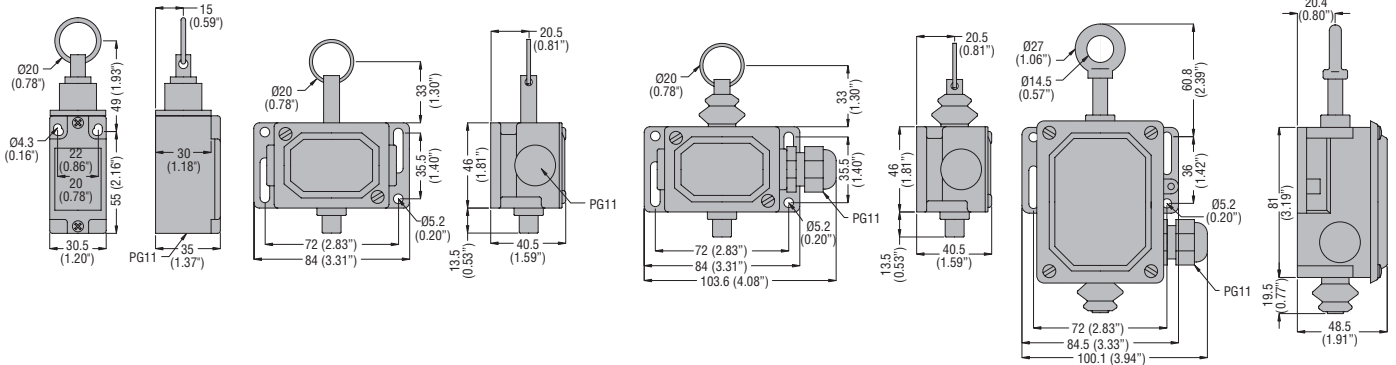

PLASTIC MICRO SWITCHES

KSA1...

KSA2...

KSA3...

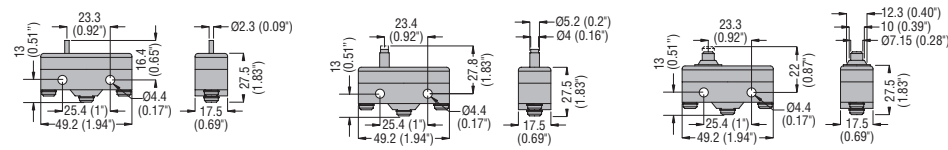

KSA4...

KSA9...

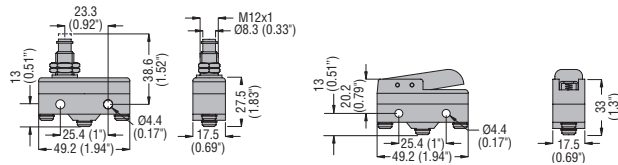

KSB1...

KSB2...

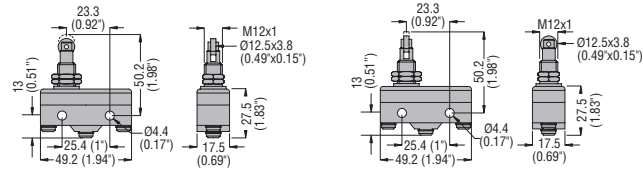

KSC1...

KSC2...

KSC3...

KSC9...

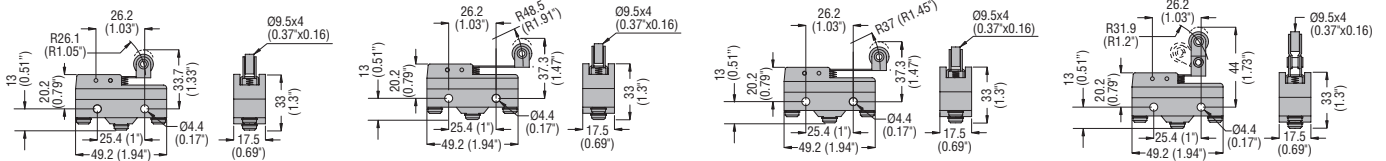

KSL1...

KSL2...

KSL3...

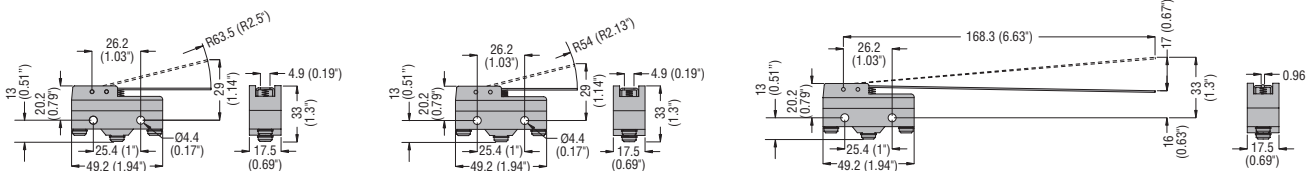

TERMINAL SHROUD

KSSC01

KSSCB2

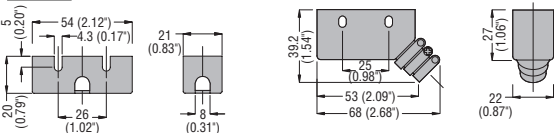

10 Limit, micro and foot switches

Dimensions [mm (in)]

INDEX

FOOT SWITCHES

KG1

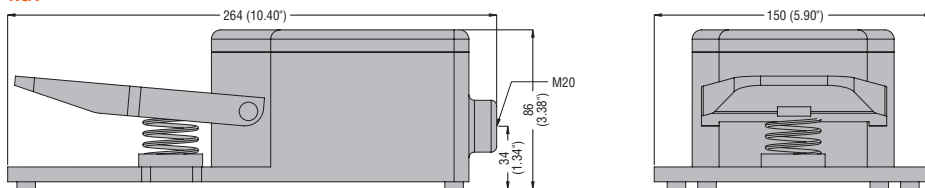

KG2

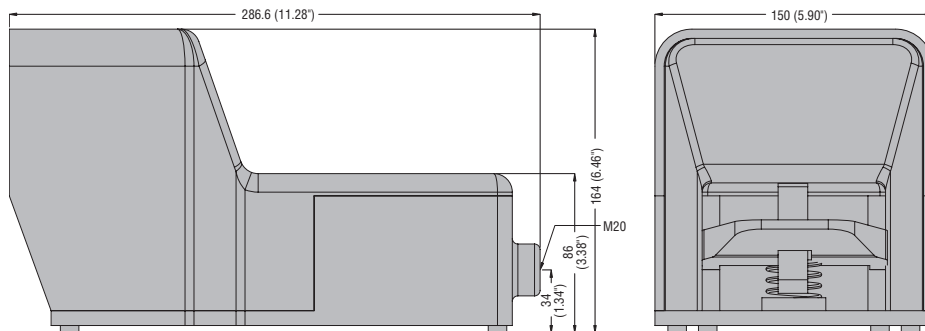

KR1

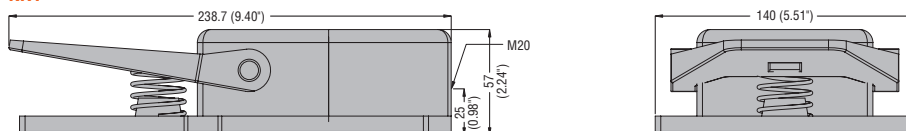

KR2

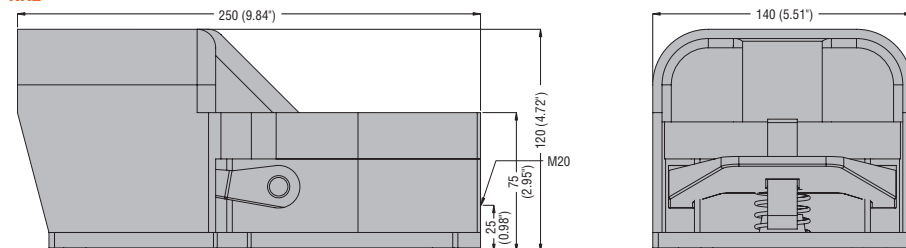

KGD

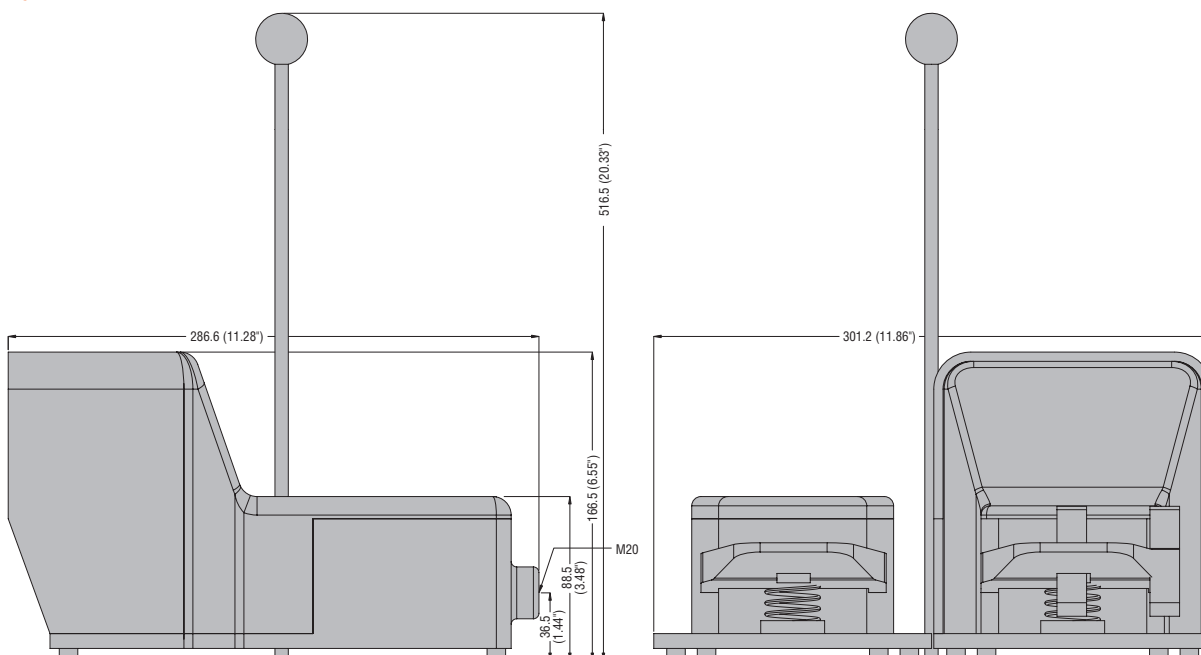

LIMIT SWITCHES, KB - KM - KC - KN TYPES

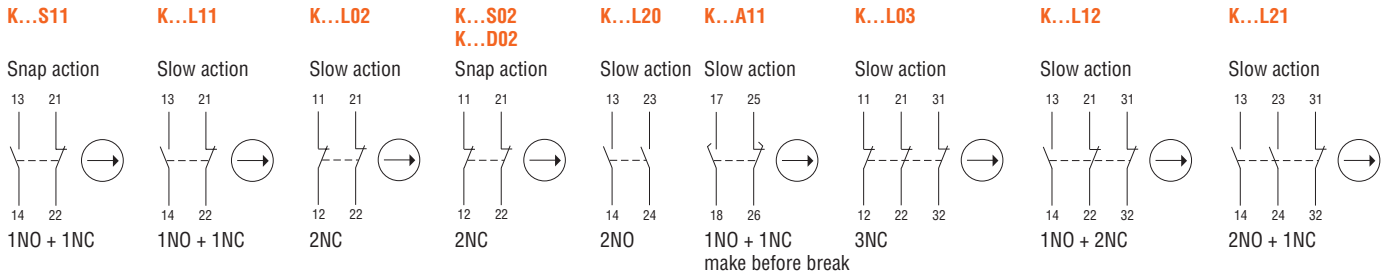

PREWIRED METAL LIMIT SWITCHES

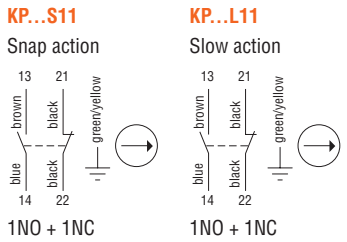

LIMIT SWITCHES, PL TYPE

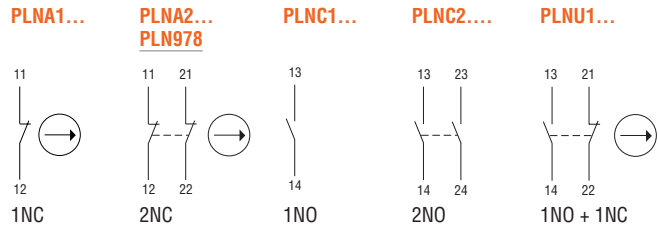

LIMIT SWITCHES FOR NORMAL STOPPING

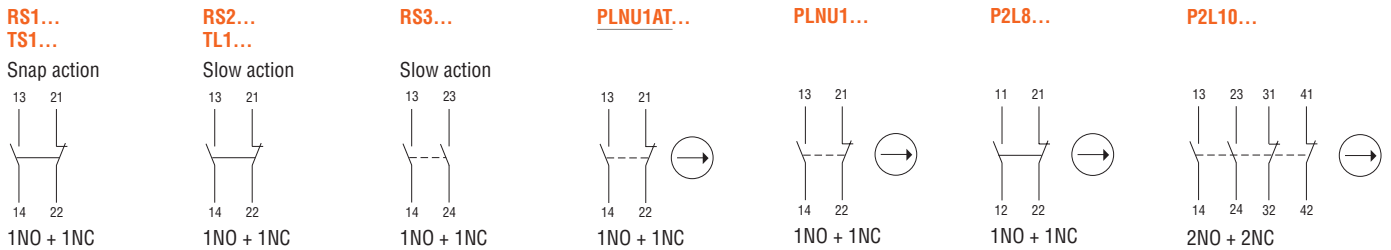

PLASTIC MICRO SWITCHES



FOOT SWITCHES

