

- Extensive selection of functions to satisfy all application requirements
- Power supply range 12-24VDC for each single product
- Totally programmable inputs, outputs and alarms
- RS232, RS485, USB, Ethernet communication interface
- Engine control by CANbus
- Setup and supervision software
- Modem control for sending alarm messages and emails.

**Engine and generator controllers**

Engine protection controllers .....	28 - 6
Stand alone gen-set controllers .....	28 - 7
Automatic mains failure (AMF) gen-set controllers .....	28 - 8
Paralleling controllers for mains-generator and generator-generator .....	28 - 9
Remote and alarm-status relay units .....	28 - 10
Communication devices and accessories .....	28 - 11
Software .....	28 - 12

<b>Dimensions</b> .....	<b>28 - 13</b>
-------------------------	----------------





Page 28-6

### STAND ALONE GEN-SET CONTROLLERS

- Generator voltage and current control
- Engine protection
- Programmable inputs and outputs
- Programmable alarm properties.



Page 28-7

### AUTOMATIC MAINS FAILURE (AMF) GEN-SET CONTROLLERS

- Automatic starting of generator and load switching to stand-by emergency source in case of mains failure
- Management in “open transition” for contactors, motorised circuit breakers and motorised changeover switches
- Engine protection
- Programmable inputs, outputs and alarms.



Page 28-8

### PARALLELING CONTROLLERS FOR MAINS-GENERATOR AND GENERATOR-GENERATOR

- Mains-generator synchronising “closed transition”
- Mains-generator load sharing with source peak demand control
- Generator paralleling management (island mode with load sharing).



Page 28-9

### REMOTE UNITS

- Remote viewing and control panels
- Remote annunciator for alarm and status indication
- Digital outputs for alarm and status condition remotely.



Page 28-11

### COMMUNICATION DEVICES, ACCESSORIES AND SOFTWARE

- Communication interfaces
- Additional digital and analog inputs and outputs
- GPRS-GSM module
- Setup and supervision software
- APP.



STAND ALONE GEN-SET CONTROLLERS				
	RGK400SA RGK420SA	RGK600SA RGK601SA	RGK700SA	RGK800SA
Generator voltage control	L1-L2-L3-N	L1-L2-L3-N	L1-L2-L3-N	L1-L2-L3-N
Current control	L1	L1-L2-L3	L1-L2-L3	L1-L2-L3-N
Rated frequency	50/60Hz	50/60Hz	50/60Hz	50/60/400Hz
Digital inputs	n° 5 neg.+1 pos. (emergency)	4 neg.+1 pos. (emergency)	6 neg.+1 pos. (emergency)	8 neg.+1 pos. (emergency)
Digital outputs	n° 5 (SSR)	6 (SSR)	3 (Relay) + 4 (SSR)	3 (Relay)+6 (SSR)+1(SO)
Engine running inputs	"D+", Hz	"D+", Hz	"D+", "AC", Hz	"D+", "AC", Hz
Ohmic inputs for fuel-pressure-temperature (programmable as digital inputs)	1+2 (EXP1040)	●	●	●
Remote supervision	-	-	●	●
CANbus interface	-	RGK601SA	●	●
Rated battery voltage	12/24VDC	12/24VDC	12/24VDC	12/24VDC
Power supply range	7...33VDC	7...33VDC	7...33VDC	7...33VDC
Mains voltage control	-	-	-	-
Rated voltage range	100...480VAC	100...480VAC	30...600VAC	30...600VAC
VT programming	●	●	●	●
Rated input current	5A/1A	5A/1A	5A/1A	5A/1A
TRMS voltage measurement	●	●	●	●
TRMS current measurement	●	●	●	●
Display	LCD with icons and backlight	Graphic backlight LCD, 128x80 pixels	Graphic backlight LCD, 128x80 pixels	Graphic backlight LCD, 128x80 pixels
Engine running magnetic pick-up input	●	RGK600SA	●	●
Engine speed input	"W" or generator frequency or "Pick-up"	"W" or generator frequency or "Pick-up" (RGK600SA)	"W" or generator frequency or "Pick-up"	"W" or generator frequency or "Pick-up"
Auxiliary analog input	-	-	-	●
I/O expansion	1 x EXP1040	RGKRR	RGKRR	3 x EXP... + RGKRR
USB/Optical port on front	●	●	●	●
Wi-Fi port on front	●	●	●	●
USB port at rear	-	-	-	EXP1010
Ethernet port with Web server function	-	-	-	EXP1013
GPRS/GSM modem	-	-	-	EXP1015
RS232 serial port	-	-	●	EXP1011
RS485 serial port	-	-	-	●
Event logging	-	●	●	●
RTC (Real Time Clock)	-	-	-	●
Programmable Inputs/Outputs	●	●	●	●
PLC logic function	-	-	●	●
Alarms	●	●	●	●
User alarms	n° 2	4	8	8
Alarm property customising	●	●	●	●
Texts for alarms, events and parameters	●	●	●	●
Multilanguage (type)	n° 5 (GB - I - F - E - D)	5 (GB - I - F - P - E)Ⓜ	5 (GB - I - F - P - E)Ⓜ	5 (GB - I - F - P - E)Ⓜ
Upload languages	-	●	●	●
Load sharing	-	-	-	-
Generator paralleling	-	-	-	-
Mains-generator synchronising (closed transition)	-	-	-	-
IEC front degree of protection	IP40, IP65 with optional gasket sealⓂ	IP40, IP65 with optional gasket seal	IP65	IP65
Certifications	cULus, EAC	cULus, EAC	cULus, EAC	cULus, EAC

① Frequency only.

Ⓜ For RGK400SA only.

Ⓜ Controller uploading of other multilanguage sets.



	AUTOMATIC MAINS FAILURE (AMF) GEN-SET CONTROLLERS				PARALLELING / LOAD SHARING CONTROLLERS	
	RGK600 RGK601 RGK610	RGK700	RGK750	RGK800	RGK900	RGK900SA
Generator voltage control	L1-L2-L3-N	L1-L2-L3-N	L1-L2-L3-N	L1-L2-L3-N	L1-L2-L3-N	L1-L2-L3-N
Current control	L1-L2-L3	L1-L2-L3	L1-L2-L3	L1-L2-L3-N	L1-L2-L3-N	L1-L2-L3-N
Rated frequency	50/60Hz	50/60Hz	50/60Hz	50/60/400Hz	50/60/400Hz	50/60/400Hz
Digital inputs	n° 4 neg.+1 pos. (emergency)	6 neg.+1 pos. (emergency)	8 neg.+1 pos. (emergency)	8 neg.+1 pos. (emergency)	12 neg.+1 pos. (emergency)	12 neg.+1 pos. (emergency)
Digital outputs	n° 6 (SSR)	3 (Relay) + 4 (SSR)	3 (Relay)+6 (SSR) +1(SO)	3 (Relay)+6 (SSR) +1(SO)	3 (Relay)+6 (SSR) +1(SO)	3 (Relay)+6 (SSR) +1(SO)
Engine running inputs	"D+", Hz	"D+", "AC", Hz	"D+", "AC", Hz	"D+", "AC", Hz	"D+", "AC", Hz	"D+", "AC", Hz
Ohmic inputs for fuel-pressure-temperature	●	●	●	●	●	●
Remote supervision	RGK610	●	●	●	●	●
CANbus interface	RGK601	●	●	●	●	●
Rated battery voltage	12/24VDC	12/24VDC	12/24VDC	12/24VDC	12/24VDC	12/24VDC
Power supply range	7...33VDC	7...33VDC	7...33VDC	7...33VDC	7...36VDC	7...36VDC
Mains voltage control	L1-L2-L3-N	L1-L2-L3-N	L1-L2-L3-N	L1-L2-L3-N	L1-L2-L3-N	-
Rated voltage range	100...480VAC	30...600VAC	100...480VAC	30...600VAC	30...600VAC	30...600VAC
VT programming	●	●	●	●	●	●
Rated input current	5A/1A	5A/1A	5A/1A	5A/1A	5A/1A	5A/1A
TRMS voltage measurement	●	●	●	●	●	●
TRMS current measurement	●	●	●	●	●	●
Display	Graphic backlight LCD, 128x80 pixels	Graphic backlight LCD, 128x80 pixels	Graphic backlight LCD, 128x80 pixels	Graphic backlight LCD, 128x80 pixels	Graphic backlight LCD, 128x112 pixels	Graphic backlight LCD, 128x112 pixels
Engine running magnetic pick-up input	RGK600/RGK610	●	●	●	●	●
Engine speed input	"W"/"Pick-up" (RGK600/RGK610) or generator frequency	"W" or generator frequency or "Pick-up"	"W" or generator frequency or "Pick-up"	"W" or generator frequency or "Pick-up"	"W" or generator frequency or "Pick-up"	"W" or generator frequency or "Pick-up"
Auxiliary analog input	-	-	●	●	●	●
I/O expansion	1 x EXP... + RGKRR	RGKRR	2 x EXP... + RGKRR	3 x EXP... + RGKRR	4 x EXP... + RGKRR	4 x EXP... + RGKRR
USB/Optical port on front	●	●	●	●	●	●
Wi-Fi port on front	●	●	●	●	●	●
USB port at rear	EXP1010 (RGK610)	-	EXP1010	EXP1010	EXP1010	EXP1010
Ethernet port with Web server function	-	-	EXP1013	EXP1013	EXP1013	EXP1013
GPRS/GSM modem	-	-	EXP1015	EXP1015	EXP1015	EXP1015
RS232 serial port	EXP1011 (RGK610)	●	EXP1011	EXP1011	EXP1011	EXP1011
RS485 serial port	EXP1012 (RGK610)	-	EXP1012	●	●	●
Event logging	●	●	●	●	●	●
RTC (Real Time Clock)	-	-	●	●	●	●
Programmable Inputs/Outputs	●	●	●	●	●	●
PLC logic function	-	●	●	●	●	●
Alarms	●	●	●	●	●	●
User alarms	n° 4	8	8	8	16	16
Alarm property customising	●	●	●	●	●	●
Texts for alarms, events and parameters	●	●	●	●	●	●
Multilanguage (type)	n° 5 (GB - I - F - P - E)Ⓜ	5 (GB - I - F - P - E)Ⓜ	5 (GB - I - F - P - E)Ⓜ	5 (GB - I - F - P - E)Ⓜ	5 (GB - I - F - P - E)Ⓜ	5 (GB - I - F - P - E)Ⓜ
Upload languages	-	●	●	●	●	●
Load sharing	-	-	-	-	●	●
Generator paralleling	-	-	-	-	-	●
Mains-generator synchronising (closed transition)	-	-	-	-	●	-
IEC front degree of protection	IP40, IP65 with optional gasket seal	IP65	IP65	IP65	IP65	IP65
Certifications	cULus, EAC	cULus, EAC	cULus, EAC	cULus, EAC	cULus, EAC	cULus, EAC



# A SUPERIOR CLASS!



● **CUSTOMISING OPTION**

There is a customising slot available on the front to show controller brand name, logo, trademark, part number, brief indication or wording, etc.

● **PROGRAMMING OPTICAL PORT**

The optical port on the panel front, using a standard USB or Wi-Fi point, allows communication with a PC, smartphone and tablet, to carry out programming, diagnostics and data download, without removing power to the electric panel.

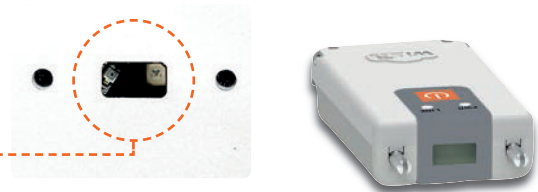

● **COMPACT SIZE**

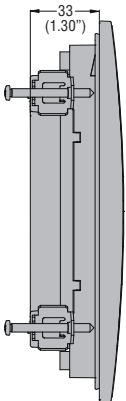

RGK700  
RGK800  
RGK900

**Slim frame profile** and reduced total depth simplify installation of the controllers in very compact electric panels.

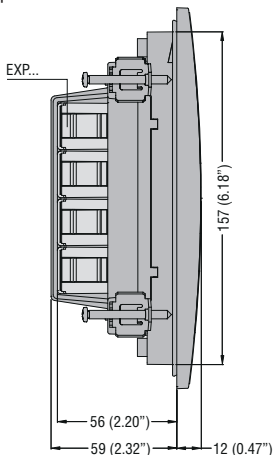

RGK800  
RGK900

● **IP65 DEGREE OF PROTECTION**

The controller front and the internal display frame seal have been designed to warrant an **IP65** protection degree. This with the **UV film** also allow outdoor installation.



● **INSTALLATION**

The fixing with **metal screws** guarantees excellent adhesion over time.



● **CABLING AND EXPANSION MODULE FIXING SYSTEM**

The controller rear has 4 fitting slots to secure cables connected to the terminals with cable ties, in an orderly way inside the electric panel. In addition, a plastic retainer is supplied as standard to keep the expansion modules in place when installed in applications with strong vibrations.

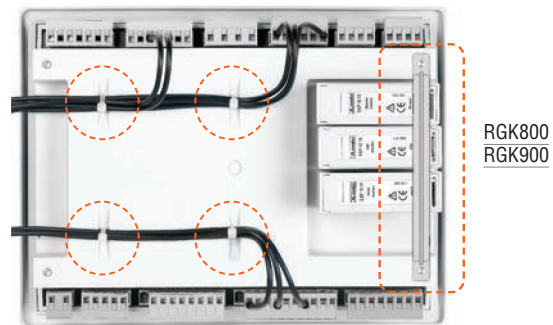

● **EXPANDABILITY**

Basic RGK750, RGK800 and RGK900 controller functions can be easily extended using up to 4 EXP series expansion modules:

- Digital and analog inputs and outputs
- Opto-isolated static outputs
- Relay outputs
- Opto-isolated RS232 interface
- Opto-isolated RS485 interface
- Opto-isolated Ethernet interface
- GPRS/GSM modem.



RGK750 (2 modules)  
RGK800 (3 modules)  
RGK900 (4 modules)



- **EXPANDABILITY**  
An extensive selection of modules is available to increase the controller functionality.
- **GPRS/GSM MODEM**  
Among the expansion modules, there is a GPRS/GSM modem, automatically configured by the genset controller.
- **MAINTENANCE**  
Maintenance supervision at programmed intervals.
- **STREAMLINE DESIGN**  
The controller has an ergonomic design and, at the same time, particular care has been given to details.

● **GPRS/GSM MODEM**



Once a data-enabled SIM card is inserted, RGK750 - RGK800 - RGK900 controllers can send SMS with alarm and event conditions as well as the latest logged events to a FTP server.

● **CANBUS COMMUNICATION PORT**  
Most models are standard equipped with CAN-J1939 communication port.

● **PLC FUNCTION**

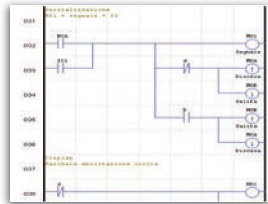

Capability to combine together internal status of controllers with signals incoming from the field to activate outputs and generate alarms.

● **LOAD MANAGEMENT**

There are different methods of controlling the load conditions; each controller has special parameters functions as follows:  
 - RGK700 - RGK750 - RGK800 types: load shedding and dummy load modes  
 - RGK900 types: base-load and peak shaving modes.

● **PARALLELING**

RGK900 and RGK900SA controllers can control the switching between the mains and generators without having to switch off the power supply to the load. In addition, they can control the paralleling connection of two or more generators sharing in this way the load on more than one source. The RGK900MC can control and synchronise mains parallel operation with a power bus composed by a series of generating sets.

● **REMOTE UNITS**

**Remote display panels**



There are "mirror" display units available to remotely operate as if in front of the generating set.

**Remote annunciator**



A remote display can view alarm conditions and can be operated for silencing them.

**Alarm-state relay unit**

The relay unit allows to transmit, on voltage-free contacts, the status and alarms of RGK... controllers.



● **SUPERVISION SOFTWARE**

**Synergy** is web-based and provides for an easy and efficient way to monitor and control electrical installations as well as field equipment.

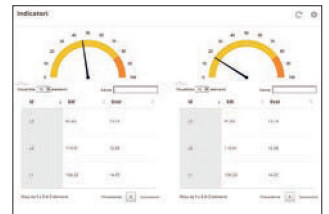

It is a server-multiclient system based on MS SQL RDBMS with web-browser interface. Simultaneous management of different communication channels with independent configuration (protocols, speed rate, RS232, RS485, Ethernet, modem) is possible. Live page view, data log tables, charts and alarms are available.

● **CLOUD SOLUTION**

The supervision software is ready as **Synergy.com** solution as well, so that the user does not have to install any package on its own servers.

● **CONFIGURATION AND REMOTE CONTROL SOFTWARE**

**Xpress** is a parameter configuration and remote monitoring software shared by the entire latest generation of RGK gen-set controllers with communication port.

## Stand alone gen-set controllers



RGK400SA



RGK420SA



Order code	Description	Qty per pkg	Wt [kg]
RGK400SA	12/24VDC, icon LCD display	1	0.410
RGK420SA	12/24VDC, icon LCD display, built-in 3 position key switch	1	0.430



The app can be downloaded from Google Play Store and App Store.



Order code	Description
ACCESSORIES FOR RGK4...SA	
EXP8005	IP65 housing gasket
EXPANSION MODULES FOR RGK4...SA Inputs and outputs.	
EXP1040	2 digital/resistive inputs, 2 static outputs
EXP1043T	4 digital input and 2 static outputs, PCB tropicalized
Communications interfaces.	
EXP1010	Opto-isolated USB interface
EXP1011	Opto-isolated RS232 interface
EXP1012	Opto-isolated RS485 interface
EXP1013	Ethernet interface
EXP1015	GPRS/GSM modem



EXP10...

### STAND ALONE APPLICATION

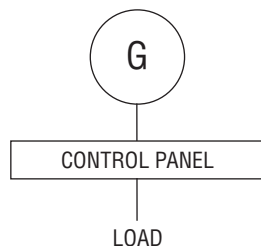

### General characteristics for RGK400SA - RGK420SA

- Key with 3 positions (OFF, local start, remote start), removable in OFF and remote start position (for RGK420SA)
- Power supply: 7...33VDC
- VAC inputs: Generator L1-L2-L3-N
- Single, two and three phase voltage control
- Rated measurement voltage range: 100...480VLL (3PH+N)
- Programmable VT ratio
- Frequency measurement range: 45...65Hz
- Current input: 1PH, /5A or /1A
- Display: LCD with icons (52x35mm/2.05x1.38")
- Programming port: IR with support of CX01 (USB) and CX02 (Wi-Fi) dongles
- NFC technology for parameter setup
- Powersave mode
- Inputs: 5 negative + 1 positive for emergency
- Outputs: 5 positive, 2A, protected
- Common pin dedicated to EV and START outputs to be used with emergency push button
- Engine running detection: "D+", Hz
- Engine speed inputs: "W" or Magnetic "Pick-up"
- 1 analog ohmic input for oil pressure, engine temperature or fuel level control
- Alarm and parameter text in 5 languages
- Customisable alarm text (2 alarms)
- Operating temperature: -30...+60°C
- Parameter configuration by NFC technology with **NFC** App freely downloadable from Google Play Store and App Store
- Compatible with **Xpress** software.

### Certification and compliance

Certifications obtained: IEC/BS 61010-1, IEC/BS 61010-2-030, IEC/BS 61000-6-2, IEC/BS 61000-6-4, UL508, CSA C22.2 n. 14.

## Stand alone gen-set controllers



RGK600SA - RGK601SA



RGK700SA - RGK800SA



EXP10...

### STAND ALONE APPLICATION

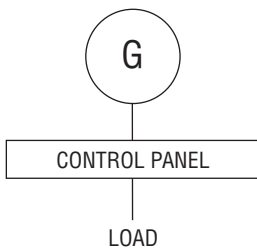

Order code	Description	Qty per pkg	Wt [kg]
<b>RGK600SA</b>	12/24VDC, graphic LCD display, w/Pick-up speed input	1	0.540
<b>RGK601SA</b>	12/24VDC, graphic LCD display, CANbus port	1	0.530
<b>RGK700SA</b>	12/24VDC, graphic LCD display, RS232 serial port, CANbus port	1	0.900
<b>RGK800SA</b>	12/24VDC, graphic LCD display, RS485 serial port, CANbus port. Expandable with EXP... modules	1	0.980

#### Programmable functions and properties

Charact.	RGK6...SA	RGK700SA	RGK800SA
<b>Inputs</b>	4	6	8
<b>Relay outputs</b>	-	3	3
<b>Protected static outputs</b>	6	4	7
<b>Resistive/Digital inputs</b>	3	3	4

Order code	Description
------------	-------------

#### ACCESSORIES FOR RGK600SA AND RGK601SA

<b>EXP8001</b>	IP65 housing gasket
----------------	---------------------

#### EXPANSION MODULES FOR RGK800SA

##### Inputs and outputs.

<b>EXP1041</b>	2 thermocouple inputs, 2 static outputs
<b>EXP1042T</b>	6 digital inputs, PCB tropicalized
<b>EXP1043T</b>	4 digital input and 2 static outputs, PCB tropicalized

##### Inputs and outputs.

<b>EXP1000</b>	4 opto-isolated digital inputs
<b>EXP1001</b>	4 opto-isolated static outputs
<b>EXP1002</b>	2 digital inputs and 2 static outputs, opto-isolated
<b>EXP1003</b>	2 relay outputs rated 5A 250VAC
<b>EXP1004</b>	2 opto-isolated analog inputs 0/4-20mA or PT100 or 0-10V or 0...±5V
<b>EXP1005</b>	2 opto-isolated analog outputs 0/4-20mA or 0-10V or 0...±5V
<b>EXP1008</b>	2 opto-isolated digital inputs and 2 relay outputs rated 5A 250VAC

##### Communications interfaces.

<b>EXP1010</b>	Opto-isolated USB interface
<b>EXP1011</b>	Opto-isolated RS232 interface
<b>EXP1012</b>	Opto-isolated RS485 interface
<b>EXP1013</b>	Ethernet interface
<b>EXP1015</b>	GPRS/GSM modem

#### General characteristics for RGK600SA - RGK601SA - RGK700SA - RGK800SA

- Power supply: 7...33VDC
- VAC inputs: Generator L1-L2-L3-N
- Single, two and three phase voltage control
- Rated measurement voltage range:
  - 100...480VAC for RGK600SA and RGK601SA
  - 30...600VAC for RGK700SA and RGK800SA
- Programmable VT ratio
- Frequency measurement range: 45...65Hz
- Current input: 3PH, /5A or /1A
- Graphic LCD: 128x80 pixels with backlight
- Programming port: IR with support of CX01 (USB) and CX02 (Wi-Fi) dongles
- Common pin dedicated to EV and START outputs to be used with emergency push button
- Engine running detection: "D+", Hz
- Engine speed inputs: "W" or Magnetic "Pick-up" (RGK601SA excluded)
- 1 CANbus-J1939 port (RGK600SA excluded)
- 3 analog ohmic inputs for oil pressure, engine temperature and fuel level control
- 1 built-in alarm remote port
- Non-volatile memory for event storage
- Alarm, event and parameter text in 5 languages
- Customisable alarm text (8 alarms)
- Operating temperature: -30...+70°C
- Modbus-RTU and Modbus-ASCII protocols
- Compatible with Synergy, Synergy<sub>com</sub> and Xpress software.

#### For RGK700SA - RGK800SA only

- PLC logic for inputs, outputs and internal status
- 1 communication port: RS232 for RGK700SA; RS485 for RGK800SA
- Degree of protection: IEC IP65 on front; suitable for use with UL/CSA Type 4X outdoor enclosure installation.

#### For RGK800SA only

- Neutral current measurement range: 0.050...6A or 0.050...1.2A
- 400Hz frequency support
- 1 programmable analog input
- Modbus-TCP communication protocol
- Current leakage control towards earth/ground
- Clock-calendar (RTC)

#### Certification and compliance

Certifications obtained: UL Listed, for USA and Canada (cULus - File E93601), as Auxiliary Devices - Generator controllers; EAC. Compliant with standards for RGK600/601: IEC/BS 61010-1, IEC/BS 61010-2-030, IEC/BS 61000-6-2, IEC/BS 61000-6-3, UL508, CSA C22.2 n. 14. Compliant with standards for RGK700 and RGK800: IEC/BS 61010-1, IEC/BS 61000-6-2, IEC/BS 61000-6-3, UL508, CSA C22.2 n. 14.

#### Synergy, Synergy<sub>com</sub>, and Xpress software

See Section 30.

#### EXP series expansion modules

See Section 31, page 2.



## Automatic mains failure (AMF) gen-set controllers



RGK600 - RGK601 - RGK610



RGK700 - RGK800



RGK750



EXP10...

### AMF (AUTOMATIC MAINS FAILURE) APPLICATION

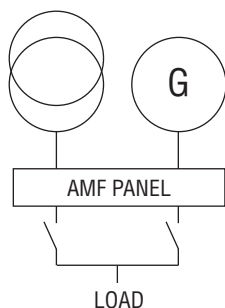

Order code	Description	Qty per pkg	Wt [kg]
RGK600	W/Pick-up speed input	1	0.540
RGK601	CANbus port	1	0.540
RGK610	W/Pick-up speed input, expandable with EXP... modules	1	0.600
RGK700	RS232 serial port, CANbus port	1	0.880
RGK750	CANbus port, expandable with EXP... modules	1	0.960
RGK800	RS485 serial port, CANbus port, expandable with EXP... modules,	1	0.960

#### Programmable functions and properties

Characteristic	RGK600 RGK601 RGK610	RGK700	RGK750	RGK800
<b>Inputs</b>	4	6	8	8
<b>Relay outputs</b>	–	3	3	3
<b>Protected static outputs</b>	6	4	7	7
<b>Resistive/Digital inputs</b>	3	3	3	4

Order code	Description
ACCESSORY FOR RGK600, RGK601 AND RGK610	

**EXP8001** IP65 housing gasket

EXPANSION MODULES FOR RGK610, RGK750 AND RGK800  
Communications interfaces.

**EXP1010** Opto-isolated USB interface

**EXP1011** Opto-isolated RS232 interface

**EXP1012** Opto-isolated RS485 interface

Inputs and outputs.

**EXP1042T** 6 digital inputs, PCB tropicalized

**EXP1043T** 4 digital input and 2 static outputs, PCB tropicalized

EXPANSION MODULES FOR RGK750

Inputs and outputs.

**EXP1000** 4 opto-isolated digital inputs

**EXP1001** 4 opto-isolated static outputs

**EXP1002** 2 digital inputs and 2 static outputs, opto-isolated

**EXP1003** 2 relay outputs rated 5A 250VAC

**EXP1008** 2 opto-isolated digital inputs and 2 relay outputs rated 5A 250VAC

EXPANSION MODULES FOR RGK800

Inputs and outputs.

**EXP1004** 2 opto-isolated analog inputs 0/4-20mA or PT100 or 0-10V or 0...±5V

**EXP1005** 2 opto-isolated analog outputs 0/4-20mA or 0-10V or 0...±5V

**EXP1040** 2 digital/resistive inputs, 2 static outputs

**EXP1041** 2 thermocouple inputs, 2 static outputs

Communications interfaces.

**EXP1013** Ethernet interface with Web server function

**EXP1015** GPRS/GSM modem

### General characteristics for RGK600 - RGK601 - RGK610 - RGK700 - RGK750 - RGK800

- Power supply: 7...33VDC
- VAC inputs: mains and generator L1-L2-L3-N
- Voltage control for one, two and three phase systems with or without neutral
- Rated measurement voltage range:
  - 100...480VAC for RGK600, RGK601, RGK610 and RGK750
  - 30...600VAC for RGK700 and RGK800
- Frequency measurement range: 45...65Hz
- Programmable VT ratio
- Current measurement range (3 PH): 0.050...6A or 0.050...1.2A
- Graphic LCD: 128x80 pixels with backlight
- 1 USB/optical and Wi-Fi port on front for programming
- Engine running detection: “D+”, generator voltage and frequency
- Engine speed inputs: “W” or Magnetic “Pick-up” (RGK601 excluded)
- 1 CANbus-J1939 port (RGK600 and RGK610 excluded)
- 3 analog ohmic inputs for oil pressure, engine temperature and fuel level control
- 1 built-in alarm remote port
- Non-volatile memory for event storage
- Alarm, event and parameter text in 5 languages
- Alarm text customisable (8 alarms)
- Event log
- Modbus-RTU and Modbus-ASCII communication protocols (RGK600 and RGK601 excluded)
- Compatible with Synergy, Synergy<sub>cloud</sub> and Xpress software
- 1 slot for EXP modules for RGK610
- 2 slots for EXP modules for RGK750
- 3 slots for EXP modules for RGK800.

#### For RGK700 - RGK750 - RGK800 only

- PLC logic for inputs, outputs and internal status
- Degree of protection: IEC IP65 on front.

#### For RGK700 - RGK800 only

- 1 communication port: RS232 for RGK700; RS485 for RGK800
- Degree of protection: IEC IP65 on front; suitable for use with UL/CSA Type 4X outdoor enclosure installation.

#### For RGK800 only

- Neutral current measurement range: 0.050...6A or 0.050...1.2A
- 400Hz frequency support
- 1 programmable analog input
- Modbus-TCP communication protocol
- Current leakage control towards earth/ground
- Clock-calendar (RTC).

#### Certifications and compliance

Certifications obtained: UL Listed, for USA and Canada (cULus - File E93601), as Auxiliary Devices - Generator controllers except for RGK750; EAC (except for RGK750). Compliant with standards: IEC/EN/BS 61010-1, IEC/EN/BS 61000-6-2, IEC/EN/BS 61000-6-3, UL 508, CSA C22.2 n° 14.

Synergy, Synergy<sub>cloud</sub>, and Xpress software  
See Section 30.

EXP series expansion modules  
See Section 31, page 2.

## Paralleling controllers for mains-generator and generator-generator



RGK900SA - RGK900

Order code	Description	Qty per pkg	Wt [kg]
		n°	[kg]

RS485 port and USB/optical and Wi-Fi point programming port on front. Expandable with EXP... modules

<b>RGK900SA</b>	Stand-alone controller. Paralleling control among generating sets	1	1.040
<b>RGK900</b>	AMF (Automatic Mains Failure) controller. Mains-generator paralleling control	1	1.040
<b>RGK900MC</b>	Mains-ATS (Automatic Transfer Switching) controller. Control of mains, automatic transfer switching (ATS) and paralleling on multiple generators controlled by RGK900SA.	1	1.040

Order code	Description
------------	-------------

EXPANSION MODULES FOR RGK900...  
Inputs and outputs.

<b>EXP1000</b>	4 opto-isolated digital inputs
<b>EXP1001</b>	4 opto-isolated static outputs
<b>EXP1002</b>	2 digital inputs and 2 static outputs, opto-isolated
<b>EXP1003</b>	2 relay outputs rated 5A 250VAC
<b>EXP1004</b>	2 opto-isolated analog inputs 0/4-20mA or PT100 or 0-10V or 0...±5V
<b>EXP1005</b>	2 opto-isolated static outputs 0/4-20mA or 0-10V or 0...±5V
<b>EXP1008</b>	2 opto-isolated digital inputs and 2 relay outputs rated 5A 250VAC
<b>EXP1041</b>	2 thermocouple inputs, 2 static outputs

Inputs and outputs.

<b>EXP1042T</b>	6 digital inputs, PCB tropicalized
<b>EXP1043T</b>	4 digital input and 2 static outputs, PCB tropicalized

Communications interfaces.

<b>EXP1010</b>	Opto-isolated USB interface
<b>EXP1011</b>	Opto-isolated RS232 interface
<b>EXP1012</b>	Opto-isolated RS485 interface
<b>EXP1013</b>	Ethernet interface with web server function
<b>EXP1015</b>	GPRS/GSM modem



EXP10...

EXP series expansion modules  
See Section 31, page 2.

### General characteristics

- Power supply: 7...36VDC
- VAC inputs: mains L1-L2-L3-N (not RGK900SA)
- VAC inputs: generator L1-L2-L3-N
- Voltage measurement rated value: 600VAC (UL/CSA)
- Voltage measurement range: 30...720VAC
- Frequency measurement range: 45...65Hz or 360...440Hz
- Programmable VT ratio
- Current measurement input (3 PH+N): 0.05...6A or 0.05...1.2A
- Fourth CT for neutral measurement or earth/ground leakage detection
- Graphic LCD, 128x112 pixels with backlight
- 13 digital inputs
- 3 relay outputs rated 8A 250VAC
- 6 static outputs rated 2A, protected
- 1 static output 50mA
- Engine running detection: "D+" generator voltage and frequency
- 1 engine speed input: "W" or "Magnetic Pick-up"
- 3 analog ohmic inputs for oil pressure, engine temperature and fuel level control
- 1 programmable analog input
- 2 analog outputs for engine speed control (governor) / voltage regulator (AVR)
- Alarm-event-parameter text in 5 languages
- Alarm text customisable (16 alarms)
- Event log
- Modbus-RTU, Modbus-ASCII and Modbus-TCP communication protocols
- PLC logic for inputs, outputs and internal status
- Compatible with Synergy, Synergy<sub>net</sub> and Xpress software
- Degree of protection: IEC IP65 on front; suitable for use with UL/CSA Type 4X outdoor enclosure installation
- Built-in buzzer
- Multi-level passwords
- Sleep function (power saving mode)
- Synchronising and load sharing.

### MAIN FUNCTIONS

- Menus for quick selection of rated parameter settings
- Mains / Generator controls: phase sequence, phase loss, max and min voltage and frequency, voltage asymmetry
- Programmable maintenance at various intervals
- Current leakage control towards earth/ground
- Mains-generator synchronising (ATS closed transition)
- Base-load or peak shaving management
- Paralleling supervision of generators (island mode)
- Generating set start scheduling.

### Certifications and compliance

Certifications obtained: UL Listed for USA and Canada (cULus - File E93601), as Auxiliary Devices, Generator controllers; EAC.

Compliant with standards for RGK900: IEC/BS 61010-1, IEC/BS 61010-2-030, IEC/BS 61000-6-2, IEC/BS 61000-6-3, UL508, CSA C22.2 n. 14

Synergy, Synergy<sub>net</sub>, and Xpress software  
See Section 30.

MAINS-GENERATOR PARALLELING	ISLAND MODE	ATS AND PARALLELING OF MAINS WITH MULTIPLE GENSETS
<p><b>RGK900</b> is designed for mains-generator synchronising applications, such as:</p> <ol style="list-style-type: none"> <li>Single generator in maintained parallel with the mains in "base-load" mode (generator power supplied at a steady rate)</li> <li>Single generator in maintained parallel with the mains, in peak-shaving mode (import-export – mains power is limited to constant value and load peaks during heavy demand for power are supplied by generator)</li> <li>Single generator in AMF with temporary parallel with the mains (for emergency, with AMF in closed transition).</li> </ol>	<p><b>RGK900SA</b> is designed for applications with load sharing on an isolated bus, without mains:</p> <ol style="list-style-type: none"> <li>Parallel among generators working together in island mode on power bus with load shared among them</li> <li>Generators connected together to maintain the power reserve (total power available minus load power) within a preset range, switching on and off generators according to a priority level.</li> </ol>	<p>Combination of RGK900SA and RGK900MC units is designed for load govern controls with multiple generators in parallel on power bus and mains. In these circumstances, the <b>RGK900MC</b> unit controls, in base-load or peak-shaving mode, the mains and power bus composed by multiple generators, each controlled by an <b>RGK900SA</b>.</p>

## Remote units



RGK800RD



RGKRA

## Alarm-status relay unit



RGKRR

Order code	Description	Qty per pkg	Wt [kg]
<b>RGK800DSA</b>	Remote display panel for RGK800SA controllers	1	0.820
<b>RGK800RD</b>	Remote display panel for RGK800 controllers	1	0.820
<b>RGK900DSA</b>	Remote display panel for RGK900SA controllers	1	0.980
<b>RGK900RD</b>	Remote display panel for RGK900 controllers	1	0.980
<b>RGKRA</b>	For RGK7..., RGK8..., RGK9..., controllers graphic LCD, touch screen 128x112 pixels	1	0.360

Order code	Description	Qty per pkg	Wt [kg]
<b>RGKRR</b>	Alarms-status relay unit 12/24VDC, 12 relay outputs, pulse input, CANbus communication port	1	0.420

### Remote display panel RGK...RD characteristics

For remote controller supervision and viewing, the user operates the remote display panel as if directly in front of the generating set.

- 12/24VDC battery power supply
- Graphic LCD with backlight:
  - 128x80 pixels for RGK800...
  - 128x112 pixels for RGK900...
- 13 function and setting keys
- 10 Indication LEDs for operating modes and status
- Built-in buzzer
- 4 digital inputs
- 2 digital outputs
- Front degree of protection: IEC IP65; UL/CSA Type 4X outdoor enclosure installation
- Serial interface ports: opto-isolated RS485 (RGK...RD).

### Remote display panel RGKRA characteristics

Alarm conditions can be viewed on the remote display and alarm silencing can also be activated.

- Dual 100-240VAC / 12-24VDC power supply
- Touch screen 120x112 pixel backlight graphic LCD
- Built-in buzzer
- Static (SSR) output for global alarm signalling
- Opto-isolated RS485 interface port
- Front degree of protection: IEC IP54; UL Type 1.

### Alarm-status relay unit RGKRR characteristics

External relay expansion unit for alarm and status remoting.

Fixing on 35mm DIN rail (IEC/EN/BS 60715).

Communication with RGK... controllers by CANbus or pulse inputs:

- 12 relay outputs of which 5 with changeover (SPDT) contact rated 5A 250VAC / B300 and 7 N/O (SPST) contact rated 2.5A 250VAC / C300
- 12/24VDC power supply
- Up to 2 RGKRR units can be connected in cascade for a total of 24 relays
- Maximum installation distance from the RGK6... and RGK700... RGK900 controllers:
  - CANbus: 30m/33yd (high speed)
  - Inputs/Outputs: 1,000m/1,094yd (low speed).

### Certifications and compliance

Certifications obtained: UL Listed, for USA and Canada (cULus – File E93601), as Auxiliary Devices, Generator controllers remote and relay units; EAC.

Comply with standards: IEC/EN/BS 61010-1, IEC/EN/BS 61000-6-2, IEC/BS 61000-6-3, UL508, CSA C22.2 n° 14.

For wiring schemes and technical characteristics, refer to technical instructions in Downloads area of local or global website [www.LovatoElectric.com](http://www.LovatoElectric.com) or consult Technical support; see contact details on inside front cover.

## Communication devices for RGK4... - RGK6... - RGK7... - RGK8... - RGK9...



CX01



CX02



CX03

Order code	Description	Qty	Wt
		per pkg	
		n°	[kg]
<b>CX01</b>	USB/optical device with PC↔controller connecting cable for programming, data download, diagnostics and firmware upgrade	1	0.090
<b>CX02</b>	Wi-Fi dongle for PC ↔ controller programming, data download, diagnostics, project upload/download and controller cloning	1	0.090
<b>CX03</b>	GSM/GPRS penta-band antenna (850/900/1800/1900/2100MHz)	1	0.090

### General characteristics

Communication and connection devices for generator set controllers RGK4... - RGK6... - RGK7... - RGK8... - RGK9... for personal computers, smartphones, tablets, modems, bus drives.

#### CX01

The USB/optical device, complete with cable, allows to connect RGK4... - RGK6... - RGK7... - RGK8... - RGK9... controllers to a PC without having to disconnect the power supply from the electric panel and to carry out parameter programming, data and event download, diagnostics and firmware upgrade. The PC identifies the connection as a standard USB.

#### CX02

By Wi-Fi connection, RGK4... - RGK6... - RGK7... - RGK8... - RGK9... controllers can be viewed by PC, smartphone and tablet with no need for cabling and to carry out parameter programming, data and event download, diagnostics project upload/download and controller cloning.

#### CX03

Antenna compatible with the major part of worldwide mobile networks thanks to the available frequencies at 850/900/1800/1900/2100MHz. IP67 IEC protection degree. Fixing by Ø10mm/0.39" drilling. Cable length 2.5m/7.23yd.

For wiring schemes and technical characteristics, refer to technical instructions in Downloads area of local or global website [www.LovatoElectric.com](http://www.LovatoElectric.com) or consult Technical support; see contact details on inside front cover.

## Accessories



EXCCON01



EXCM4G01



EXCGLA01



EXCGLAX1



EXCGSM01

Order code	Description	Qty	Wt
		per pkg	
		n°	[kg]
Connecting cable.			
<b>51C2</b>	PC↔RGK... connecting cable, 1.8m/6ft long	1	0.090
Converters.			
<b>EXCCON01</b>	RS485/ Ethernet converter, 12...48VDC, including DIN rail fixing kit	1	0.400
Gateway.			
<b>EXCM4G01</b>	4G Gateway with RS485 and Ethernet port, Modbus RTU/TCP protocol	1	0.300
<b>EXCGLA01</b>	Gateway data logger for data collecting via Modbus from the device in the field. Publishing of the data to supervision software, also in Cloud	1	0.600
<b>EXCGLAX1</b>	2G/4G modem communication module for EXCGLA01	1	0.160
GSM Modem (modular - 4U). IP69K exterior aerial with 2.5m cable. RJ45-USB programming cable (included).			
<b>EXCGSM01</b>	100...240VAC, 1 digital input, 1 analogic input (0...10V, 0...20mA, NTC), 1 relay output, receiving and sending SMS messages for remote controls and alarm signals	1	0.340
For RGK600..., RGK601... and RGK610 controllers.			
<b>EXP8001</b>	IP65 144mm/5.67" housing gasket		
For RGK4...SA.			
<b>EXP8005</b>	IP65 110mm/4.33" housing gasket		

### General characteristics

For general characteristics of converters and gateway see section 31.



### Synergy Supervision and Energy management software



### Xpress Parameter configuration and remote control software

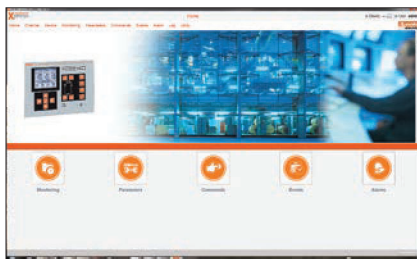

### Sam1 APP

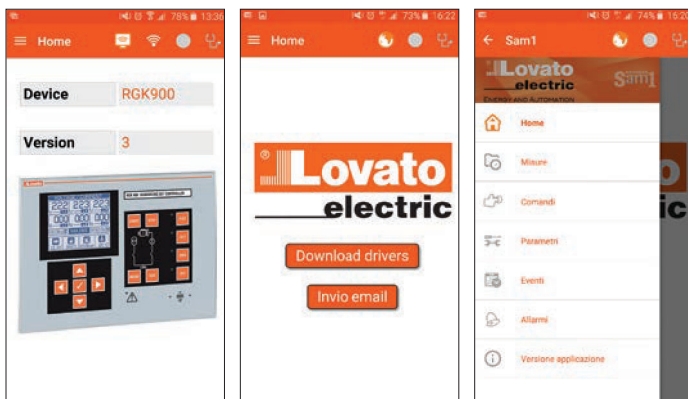

### NFC APP



### Supervision and Energy management software

The **Synergy** and **Synergy<sub>cloud</sub>** softwares provides for the remote control and supervision of the RGK... controllers. See details given in Section 30.

Its structure and applications are based on MS SQL relational database management system. Consulting is made through popular programs for Internet browsing available across different platforms and operating systems.

It is a highly versatile system, simultaneously accessible to a large number of users/workstations via intranets, VPN or Internet.

### Parameter configuration and remote control software

The **Xpress** at the beginning and just say "Express is a parameter configuration and remote monitoring software shared by the entire latest generation of RGK gen-set controllers with communication port. It can be installed in the Windows® environment and connect individually (one node at a time) to the RGK gen-set controller connected to the network.

- Supports connection via CX01 (USB) or CX02 (Wi-Fi) dongle, USB, RS232, RS485, Ethernet and modem
  - Product configuration:
    - Parameter setting
    - Project file management
  - Product firmware upgrade (via CX01)
  - Remote control:
    - Monitoring of main measurements
    - Sending commands to products
  - Reading alarms and events memory.
- See details given in Section 30.

### APP for smartphone and tablets

**Sam1** application allows the user to program the controller, view alarm conditions, send commands, read measurements, download statistical data and events and send retrieved data by email. The connection is made by Wi-Fi with a smartphone or tablet using CX02 dongle. It is iOS and Android compatible. For more details, see Section 30 or consult Technical support; see contact details on inside front cover.

**NFC** App for RGK4...SA, with integrated NFC technology, allows remote parameter configuration.

The parameters can be saved in a file for archive purposes. It is Android and iOS compatible. For more details, see Section 30 or consult Technical support; see contact details on inside front cover.

### STAND-ALONE GEN-SET CONTROLLERS

#### RGK400SA

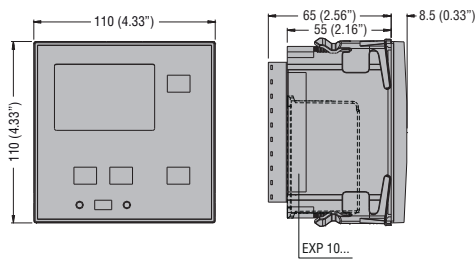

#### RGK420SA

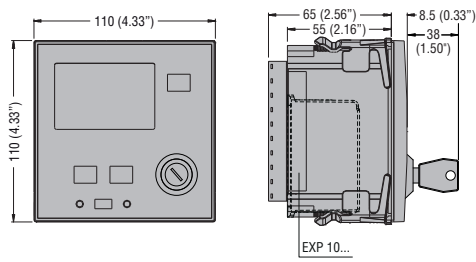

#### Cutout

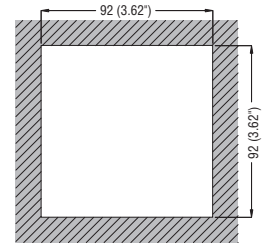

### GEN-SET CONTROLLERS **RGK600...** - **RGK601...** - **RGK610**

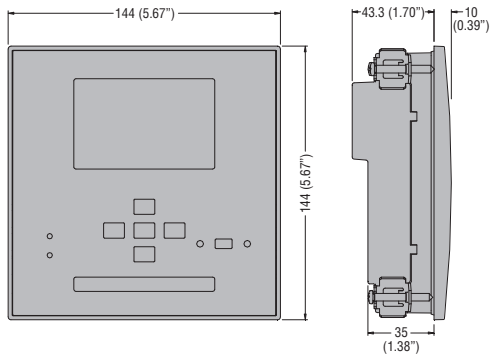

#### Cutout

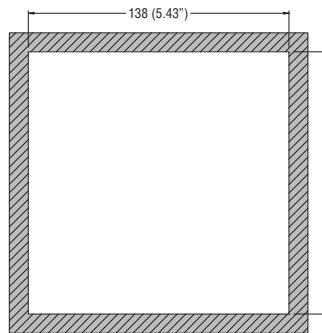

### GEN-SET CONTROLLERS **RGK700...** - **RGK750...** - **RGK800...** - **RGK900...** - REMOTE DISPLAY PANELS **RGK800RD** - **RGK800RDSA** - **RGK900RD** - **RGK900RDSA**

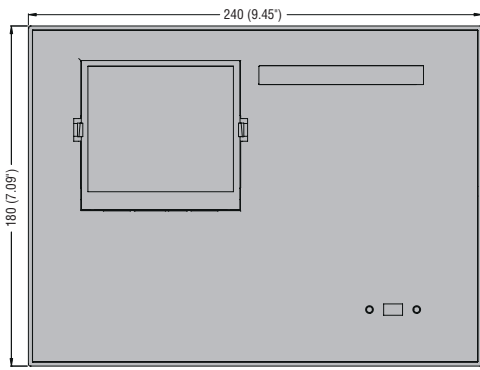

❶ RGK 700, RGK 800RD..., RGK 900RD... excluded.

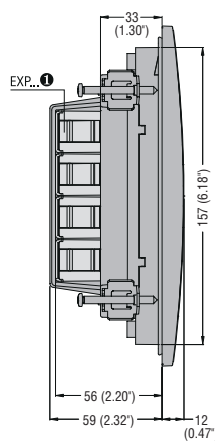

#### Cutout

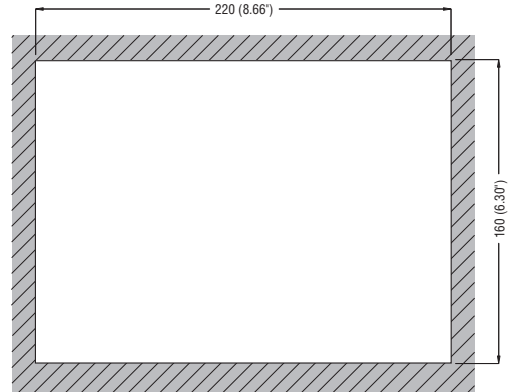

### REMOTE DISPLAY UNIT **RGKRA**

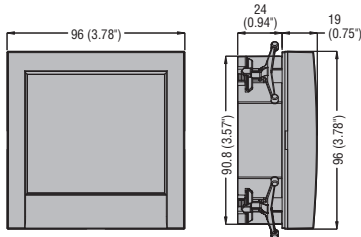

#### Cutout

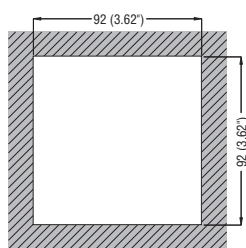

### ALARM-STATUS RELAY UNIT **RGKRR**

