



**Schemi
commutatori
a camme
serie GX e GN**

**Circuit schemes
rotary cam
switches GX
and GN series**



**al servizio
del cliente**

**at the customer's
service**

Ufficio vendite

Tel 035 4282421

Fax 035 4282460

E-mail vendite@LovatoElectric.com

Sales Office

Tel +39 035 4282354

Fax +39 035 4282400

E-mail sales@LovatoElectric.com

Servizio Clienti Technical Support and Customer Care

Tel +39 035 4282422

Fax +39 035 4282295

E-mail service@LovatoElectric.com

Informazioni on line On line information

www.LovatoElectric.com

Sede principale Head Office

Via Don E. Mazza, 12

24020 GORLE, BERGAMO (Italy)

Tel +39 035 4282111

Fax +39 035 4282200

E-mail info@LovatoElectric.com

I prodotti descritti in questo documento sono suscettibili in qualsiasi momento di evoluzioni o di modifiche. Le descrizioni ed i dati a catalogo e listino prezzi non possono pertanto avere nessun valore contrattuale. Si ricorda altresì che i prodotti stessi devono essere utilizzati da personale qualificato e comunque nel rispetto delle vigenti normative impiantistiche di installazione e ciò allo scopo di evitare danni a persone e cose.

The products illustrated in this publication are subject to be revised or improved at any moment. Catalogue descriptions, technical and operational data as well as other details herein specified do not have any contractual value so must be considered only as indication. The products must be installed and used by qualified personnel and in compliance with the regulations in force for electrical systems in order to avoid damages and safety hazards.

**Lovato**
electric





GX...

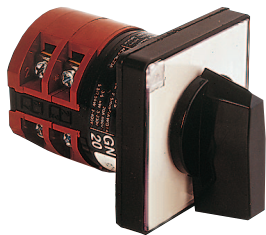

GN...

Modalità di codifica / Order code structure	4
Tabella schemi speciali / Special circuit scheme form	5
Interruttori con angolo di rotazione 60° / On-Off switches with 60° switching	6
Interruttori con angolo di rotazione 90° / On-Off switches with 90° switching	7
Interruttori ad impulso con angolo di rotazione 30° con ritorno a "0" / Switches-spring return with 30° switching	8
Commutatori con angolo di rotazione 60° / Changeover switches with "0" - 60° switching	9
Deviatori con angolo di rotazione 90° / Changeover switches without "0" - 90° switching	10
Commutatori multivie senza "0" / Multi-step switches without "0" ..	11
Commutatori multivie con "0" / Multi-step switches with "0"	14
Commutatori a gruppi / Gang switches	21
Commutatori voltmetrici / Voltmeter switches	24
Commutatori amperometrici / Ammeter switches	25
Commutatori voltmetrici-amperometrici / Voltmeter-ammeter switches	27
Interruttori (con posizioni ad impulso) / Control switches (with spring return)	30
Invertitori di marcia / Motor reversing switches	32
Commutatori stella-triangolo / Star-delta switches	34
Commutatori di polarità (Dahlander) / Motor control switches (Dahlander)	37
Commutatori di polarità con inversione di marcia (Dahlander) / Motor control switches (Dahlander) - pole changing with reversing	38
Commutatori per motori (avvolgimenti separati) / Motor control switches (separate windings)	39
Commutatori di poli per motore a 3 velocità / Switches for 3-speed motor control	41
Invertitori di marcia con fase ausiliaria / Start and run switches ...	43
Dimensioni / Dimensions	44
Caratteristiche tecniche / Technical characteristics	46



Modalità di codifica

Order code structure

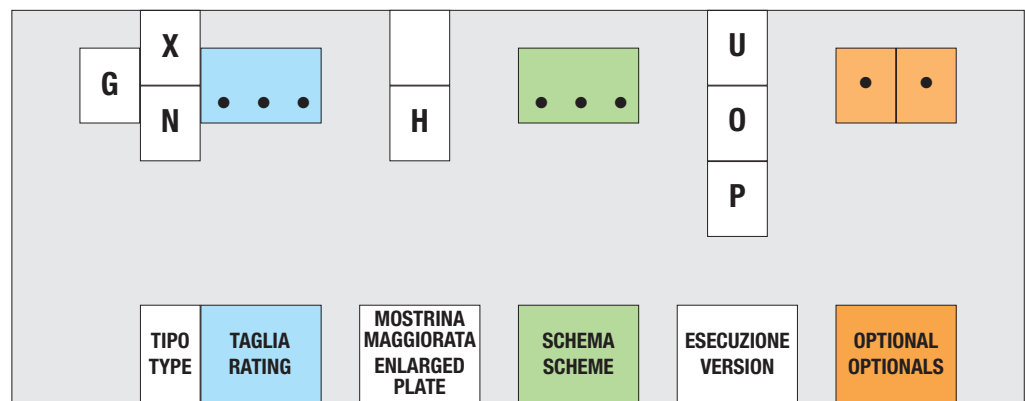

GX
Protezione/Protection:
Frontale/Front = IP65
Contatti/Contacts = IP20

GN
Protezione/Protection:
Frontale/Front = IP40
Contatti/Contacts = IP00

Aggiungere H se la mostrina deve essere maggiorata
Insert H when an enlarged front plate is required

GX16 - GX20
GN12 - GN20 - GN25
da/from 48x48mm a/to 65x65mm

GX32 - GX40
GN32 - GN40 - GN63
da/from 65x65mm a/to 90x90mm

TIPO TYPE	TAGLIA RATING
GX	GN
16A	12A
20A	20A
32A	25A
40A	32A
	40A
	63A
	125A

SCHEMA SCHEME	ESECUZIONE VERSION	OPTIONAL OPTIONALS
es./e.g.	U = montaggio frontale front mounting	
90	O = montaggio da fondo quadro rear mounting	
91	P = in cassetta in enclosure	
10		
92		
99		
100		

11	Montaggio frontale fissaggio centrale Ø22mm Front mount, with handle operation, for central 22mm fixing
12	A chiave montaggio frontale fissaggio centrale Ø22mm Front mount, with key operation, for central 22mm fixing
18	Fissaggio su guida DIN 35mm DIN rail mounting (IEC/EN 60715)
25	Maniglia lucchettabile giallo/rossa Red-yellow padlockable handle
48	Modulare fissaggio su guida DIN Modular service cover, 35mm DIN rail mounting
4V	Montaggio frontale fissaggio a 4 viti Front mount, with 4-screw fixing
51	Protezione frontale IP65 (solo GN) IP65 front protection, for GN only
65	Maniglia lucchettabile giallo/rossa Red-yellow padlockable handle
68	Bloccoporta Door coupling
78	Bloccoporta Door coupling
79	Bloccoporta (solo GN125) Door coupling, for GN125 only
88	Maniglia lucchettabile giallo/rossa, bloccoporta Door coupling, with red-yellow padlockable handle
98	Maniglia lucchettabile giallo/rossa, bloccoporta (solo GN125) Door coupling, with red-yellow padlockable handle, for GN125 only

Esempio di ordinazione / Example for ordering:

GX 16 53 P = Commutatore di linea in cassetta 90x90mm (IP65) da 16A tripolare a 3 posizioni e 3 elementi.
Changeover switch, 16A, 3 poles, 3 positions, 3 wafers in 90x90mm, IP65 enclosure.

GN 25 H 90 U 51 = Interruttore per montaggio frontale da 25A unipolare a 2 posizioni, 1 elemento, mostrina maggiorata 65x65mm con protezione frontale IP65.
On-Off switch, 25A, 1 pole, 2 positions, 1 wafer, with enlarged 65x65mm front plate and IP65 protection.

Tabella schemi speciali

Special circuit scheme form

		1	4	5	8	9	12	13	16	17	20	21	24	25	28	29	32	33	36	37	40	41	44	45	48		
		2	3	6	7	10	11	14	15	18	19	22	23	26	27	30	31	34	35	38	39	42	43	46	47		
		Simbologia mostrina Plate indication	pos.																								
	7																										
	C																										
	8																										
	9																										
	10																										
	D																										
	11																										
	12																										
	1																										
	A																										
	2																										
	3																										
	4																										
	B																										
	5																										
	6																										
Mostrina frontale Front plate 		1							X							X											
		2							X							X		X								X	
			Contatti in sovrapposizione Overlapping contacts				Contatto chiuso in 2 o più posizioni Closed contact in 2 or more positions				Contatto aperto Open/passing contact				Contatto chiuso Closed contact				Autoritorno Spring return								
		Corpo / Body shape:		<input type="checkbox"/> Quadrato / Square - GX❶		<input type="checkbox"/> Rotondo / Round - GN																		Corrente nominale / Amp rating			
		Versione / Version:		<input type="checkbox"/> Montaggio frontale / Front mount		<input type="checkbox"/> Montaggio sul retro / Rear mount						<input type="checkbox"/> In cassetta Enclosed															
		Finitura / Finish:		<input type="checkbox"/> Standard❷ / Standard❷		<input type="checkbox"/> Maniglia rosso/gialla / Red/yellow padlockable																					
		Fissaggio / Fixing:		<input type="checkbox"/> 2 viti / 2 screw		<input type="checkbox"/> 4 viti / 4 screw																					
		Q.tà / Qty:		_____		Ragione sociale e persona di riferimento / Company name and contact details:		_____		_____		_____		_____		_____		_____		_____		_____		_____			
		❶ 40A nominali massimi per serie GX / Maximum 40A rating for GX series. ❷ La finitura standard ha la mostrina frontale grigia, le indicazioni 0-12 e la manopola nera. Altre tipologie sono considerate speciali / Standard finish is grey front plate, 0-12 indication and a black handle; any other is considered special.																									

Schemi commutatori a camme serie GX e GN

Circuit schemes rotary cam switches GX and GN series

Interruttori con angolo di rotazione 60°

On-Off switches with 60° switching

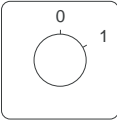
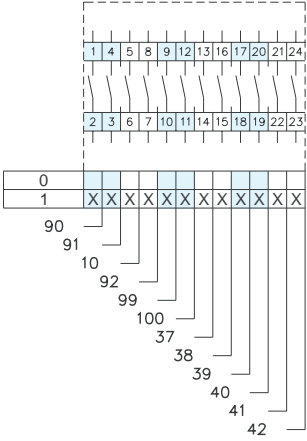
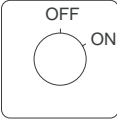
FUNZIONE FUNCTION	Mostrina Front plate	Schema Scheme	N° elem. N° of wafers	DIAGRAMMA / CONTACT CONFIGURATION
1 polo 1 pole		90	1	
2 poli 2 pole		91	1	
3 poli 3 pole		10	2	
4 poli 4 pole		92	2	
5 poli 5 pole		99	3	
6 poli 6 pole		100	3	
7 poli 7 pole		37	4	
8 poli 8 pole		38	4	
9 poli 9 pole		39	5	
10 poli 10 pole		40	5	
11 poli 11 pole		41	6	
12 poli 12 pole		42	6	
1 polo 1 pole		D90	1	
2 poli 2 pole		D91	1	
3 poli 3 pole		D10	2	
4 poli 4 pole		D92	2	
5 poli 5 pole		D99	3	
6 poli 6 pole		D100	3	

Interruttori con angolo di rotazione 90°

On-Off switches with 90° switching

FUNZIONE FUNCTION	Mostrina Front plate	Schema Scheme	N° elem. N° of wafers	DIAGRAMMA / CONTACT CONFIGURATION
1 polo 1 pole 2 poli 2 pole 3 poli 3 pole 4 poli 4 pole		05 06 07 08	1 1 2 2	
1 polo 1 pole 2 poli 2 pole 3 poli 3 pole 4 poli 4 pole		C05 C06 C07 C08	1 1 2 2	
3 poli (rotazione 360°) 3 pole (360° rotation)		09	2	
3 poli (rotazione 360°) 3 pole (360° rotation)		C09	2	
3 poli deviatore 3 pole current changeover switch		57	3	
4 poli 1 polo con chiusura anticipata 4 pole 1 pole early-make 5 poli 2 poli con chiusura anticipata 5 pole 2 pole early-make 4 poli 3 poli con chiusura anticipata 4 pole 3 pole early-make 5 poli 3 poli con chiusura anticipata 5 pole 3 pole early-make		275 277 276 278	2 3 2 3	

Interruttori a impulso con angolo di rotazione 30° con ritorno a "0"

Switches-spring return with 30° switching

FUNZIONE FUNCTION	Mostrina Front plate	Schema Scheme	N° elem. N° of wafers	DIAGRAMMA / CONTACT CONFIGURATION
1 polo 1 pole		01	1	
2 poli 2 pole		02	1	
3 poli 3 pole		03	2	
4 poli 4 pole		04	2	
1 polo 1 pole		C01	1	
2 poli 2 pole		C02	1	
3 poli 3 pole		C03	2	
4 poli 4 pole		C04	2	
1 polo 1 pole		D01	1	
2 poli 2 pole		D02	1	
3 poli 3 pole		D03	2	
4 poli 4 pole		D04	2	
1 polo 1 pole		45	1	
2 poli 2 pole		46	1	
3 poli 3 pole		47	2	
4 poli 4 pole		48	2	
1 polo 1 pole 2 poli 2 pole 3 poli 3 pole		201	1	
con ritorno a "0"		202	2	
with spring return to "0"		203	3	
1 polo 1 pole 2 poli 2 pole 3 poli 3 pole		C201	1	
con ritorno a "0"		C202	2	
with spring return to "0"		C203	3	

Commutatori con angolo di rotazione 60°

Changeover switches with "0" - 60° switching

FUNZIONE FUNCTION	Mostrina Front plate	Schema Scheme	N° elem. N° of wafers	DIAGRAMMA / CONTACT CONFIGURATION
1 polo 1 pole		51	1	
2 poli 2 pole		52	2	
3 poli 3 pole		53	3	
4 poli 4 pole		75	4	
5 poli 5 pole		76	5	
6 poli 6 pole		77	6	
7 poli 7 pole		78	7	
8 poli 8 pole		79	8	
9 poli 9 pole		80	9	
10 poli 10 pole		81	10	
11 poli 11 pole		182	1	
12 poli 12 pole		183	12	
1 polo 1 pole		D51	1	
2 poli 2 pole		D52	2	
3 poli 3 pole		D53	3	
4 poli 4 pole		D75	4	
5 poli 5 pole		D76	5	
6 poli 6 pole		D77	6	
1 polo 1 pole		E51	1	
2 poli 2 pole		E52	2	
3 poli 3 pole		E53	3	
4 poli 4 pole		E75	4	
5 poli 5 pole		E76	5	
6 poli 6 pole		E77	6	

Schemi commutatori a camme serie GX e GN

Circuit schemes rotary cam switches GX and GN series

**Deviatori con
angolo di rotazione
90°**

**Changeover
switches without
"0" - 90° switching**

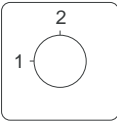
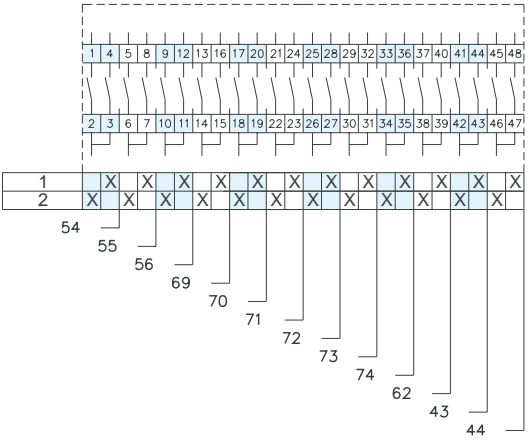
FUNZIONE FUNCTION	Mostrina Front plate	Schema Scheme	N° elem. N° of wafers	DIAGRAMMA / CONTACT CONFIGURATION
1 polo 1 pole		54	1	
2 poli 2 pole		55	2	
3 poli 3 pole		56	3	
4 poli 4 pole		69	4	
5 poli 5 pole		70	5	
6 poli 6 pole		71	6	
7 poli 7 pole		72	7	
8 poli 8 pole		73	8	
9 poli 9 pole		74	9	
10 poli 10 pole		62	10	
11 poli 11 pole		43	11	
12 poli 12 pole		44	12	

Commutatori multivie senza "0"

Multi-step switches without "0"

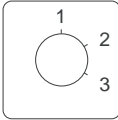
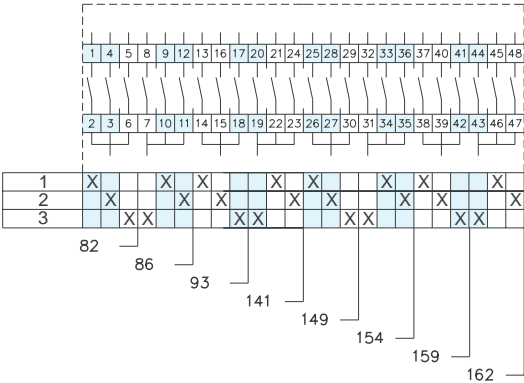
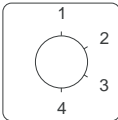
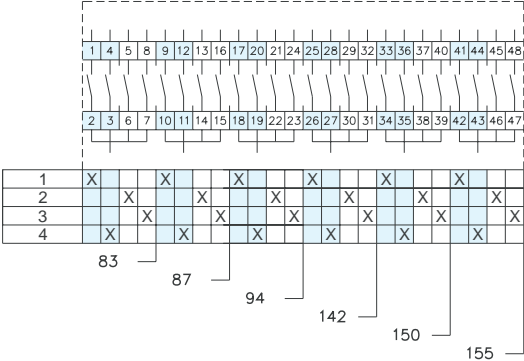
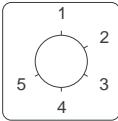
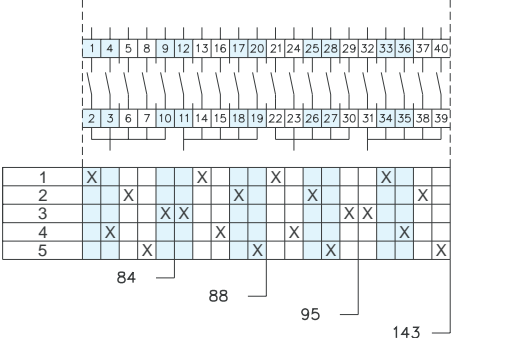
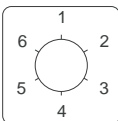
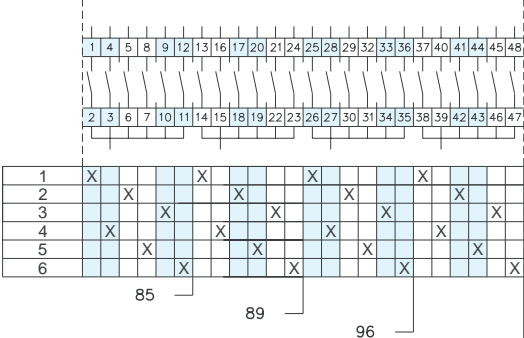
FUNZIONE FUNCTION	Mostrina Front plate	Schema Scheme	N° elem. N° of wafers	DIAGRAMMA / CONTACT CONFIGURATION
1 polo 1 pole 2 poli 2 pole 3 poli 3 pole 4 poli 4 pole 5 poli 5 pole 6 poli 6 pole 7 poli 7 pole 8 poli 8 pole 8 pole		82 86 93 141 149 154 159 162	2 3 5 6 8 9 11 12	
1 polo 1 pole 2 poli 2 pole 3 poli 3 pole 4 poli 4 pole 5 poli 5 pole 6 poli 6 pole 6 pole		83 87 94 142 150 155	2 4 6 8 10 12	
1 polo 1 pole 2 poli 2 pole 3 poli 3 pole 4 poli 4 pole 4 pole		84 88 95 143	3 5 8 10	
1 polo 1 pole 2 poli 2 pole 3 poli 3 pole 4 poli 4 pole 4 pole		85 89 96 144	3 6 9 12	

Schemi commutatori a camme serie GX e GN

Circuit schemes rotary cam switches GX and GN series

Commutatori multivie senza "0"

Multi-step switches without "0"

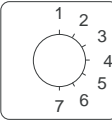
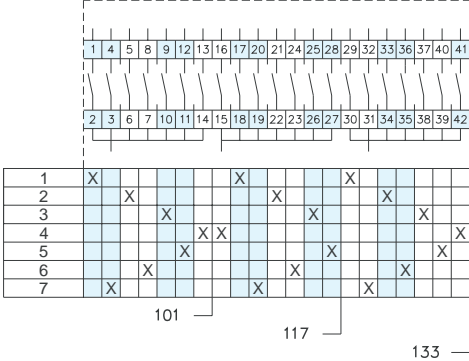
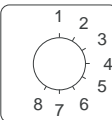
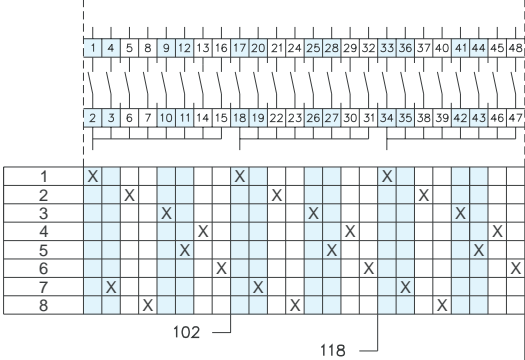
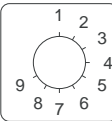
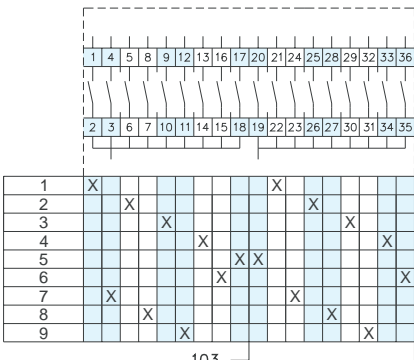
FUNZIONE FUNCTION	Mostrina Front plate	Schema Scheme	N° elem. N° of wafers	DIAGRAMMA / CONTACT CONFIGURATION
1 polo 1 pole 2 poli 2 pole 3 poli 3 pole 7 posizioni 7 positions		101 117 133	4 7 11	
1 polo 1 pole 2 poli 2 pole 3 poli 3 pole 8 posizioni 8 positions		102 118 134	4 8 12	
1 polo 1 pole 2 poli 2 pole 2 pole		103 119	5 9	

Commutatori multivie senza "0"

Multi-step switches without "0"

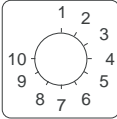
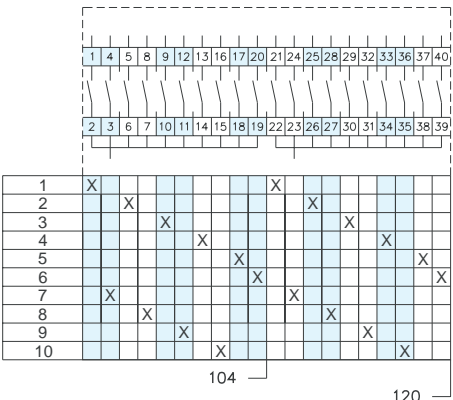
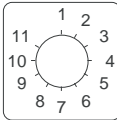
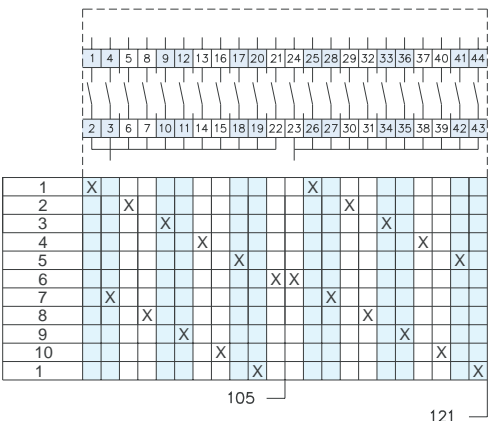
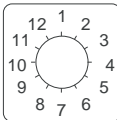
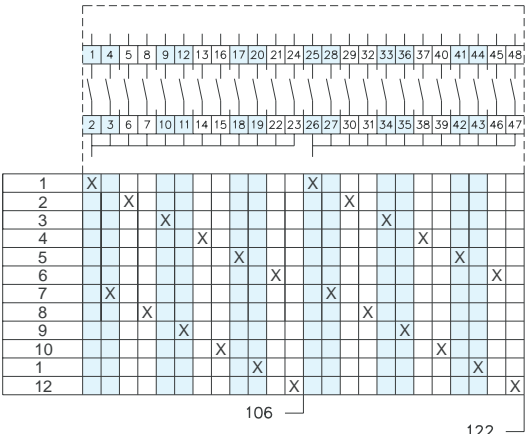
FUNZIONE FUNCTION	Mostrina Front plate	Schema Scheme	N° elem. N° of wafers	DIAGRAMMA / CONTACT CONFIGURATION
1 polo 1 pole 2 poli 2 pole 10 posizioni 10 positions		104 120	5 10	
1 polo 1 pole 2 poli 2 pole 11 posizioni 11 positions		105 121	6 11	
1 polo 1 pole 2 poli 2 pole 12 posizioni 12 positions		106 122	6 12	

Commutatori multivie con "0"

Multi-step switches with "0"

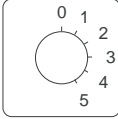
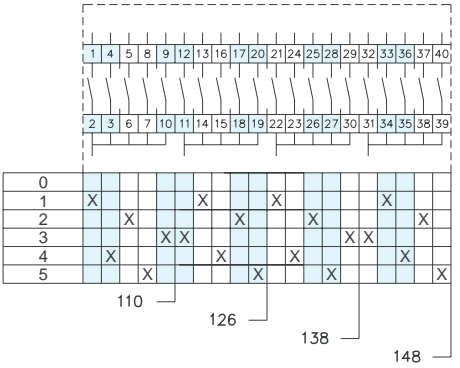
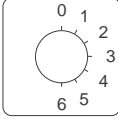
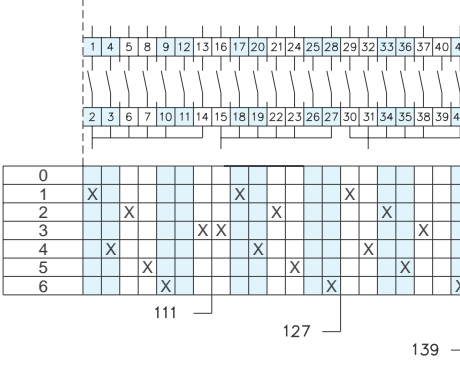
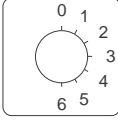
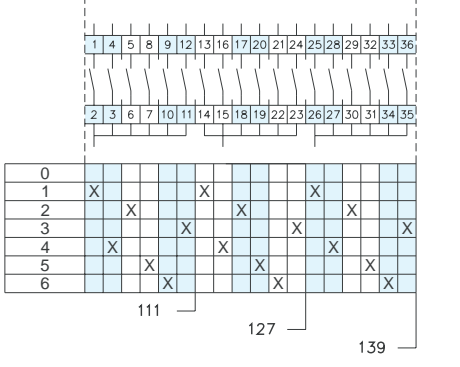
FUNZIONE FUNCTION	Mostrina Front plate	Schema Scheme	N° elem. N° of wafers	DIAGRAMMA / CONTACT CONFIGURATION
1 polo 1 pole 2 poli 2 pole 3 poli 3 pole 4 poli 4 pole 5 posizioni 5 positions		110 126 138 148	3 5 8 10	
1 polo 1 pole 2 poli 2 pole 3 poli 3 pole 3 poli 3 pole 6 posizioni 6 positions		111 127 139	4 7 11	 <p>per / for GN63</p>
1 polo 1 pole 2 poli 2 pole 3 poli 3 pole 3 poli 3 pole		111 127 139	3 6 9	 <p>per / for GX serie / series, GN12 - GN40, GN125</p>

Schemi commutatori a camme serie GX e GN

Circuit schemes rotary cam switches GX and GN series

Commutatori multivie con "0"

Multi-step switches with "0"

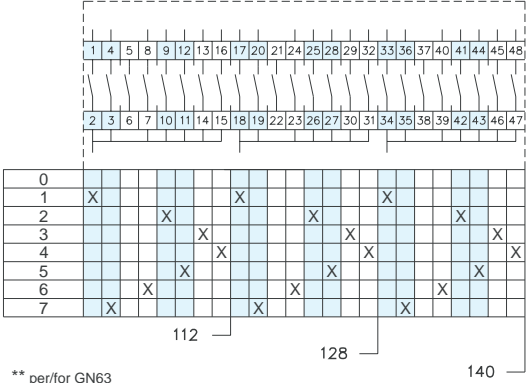
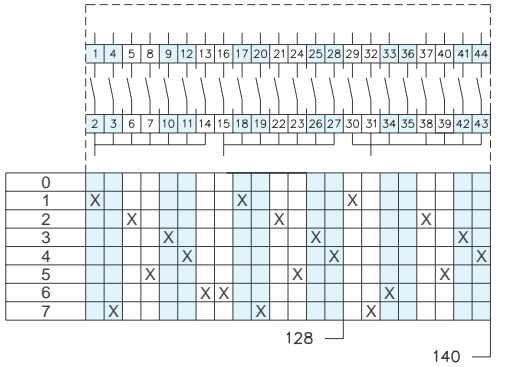
FUNZIONE FUNCTION	Mostrina Front plate	Schema Scheme	N° elem. N° of wafers	DIAGRAMMA / CONTACT CONFIGURATION
2 poli 2 pole 3 poli 3 pole 7 posizioni 7 positions		112 128** 140**	4 8 12	 <p>** per/for GN63</p>
		128 140	7 11	 <p>per / for GX serie / series, GN25, GN40, GN125</p>

Commutatori multivie con "0"

Multi-step switches with "0"

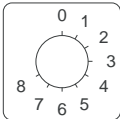
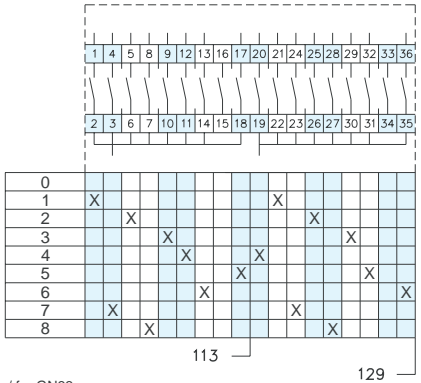
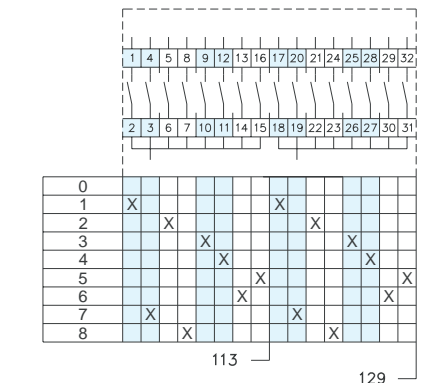
FUNZIONE FUNCTION	Mostrina Front plate	Schema Scheme	N° elem. N° of wafers	DIAGRAMMA / CONTACT CONFIGURATION
1 polo 1 pole 2 poli 2 pole 8 posizioni 8 positions		113	5	 <p style="text-align: center;">per / for GN63</p>
		129	9	 <p style="text-align: center;">per / for GX serie / series, GN12 - GN40, GN125</p>

Schemi commutatori a camme serie GX e GN

Circuit schemes rotary cam switches GX and GN series

Commutatori multivie con "0"

Multi-step switches with "0"

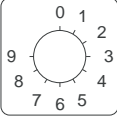
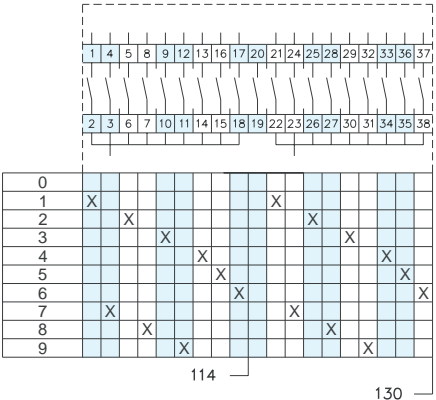
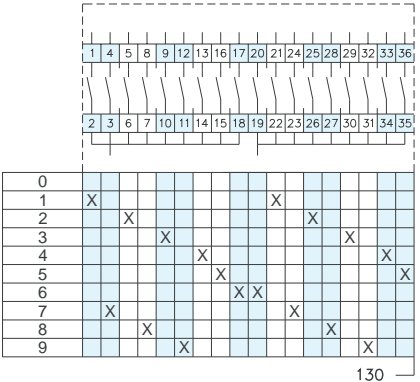
FUNZIONE FUNCTION	Mostrina Front plate	Schema Scheme	N° elem. N° of wafers	DIAGRAMMA / CONTACT CONFIGURATION
<p>1 polo 1 pole</p> <p>2 poli 2 pole</p> <p>9 posizioni 9 positions</p>		<p>114</p> <p>130**</p>	<p>5</p> <p>10</p>	 <p>** per / for GN63</p>
		<p>130</p>	<p>9</p>	 <p>per / for GX serie / series, GN12 - GN40, GN125</p>

Commutatori multivie con "0"

Multi-step switches with "0"

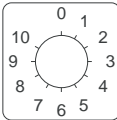
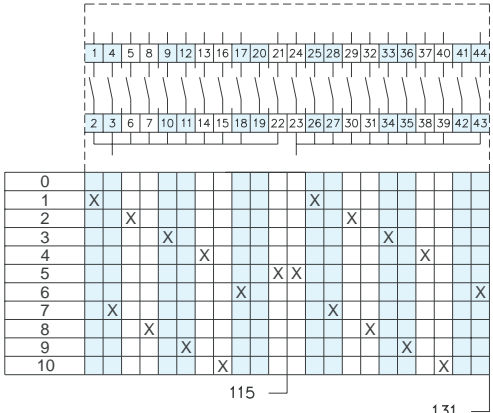
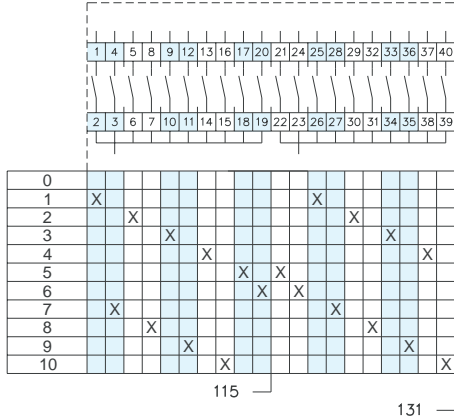
FUNZIONE FUNCTION	Mostrina Front plate	Schema Scheme	N° elem. N° of wafers	DIAGRAMMA / CONTACT CONFIGURATION
1 polo 1 pole 2 poli 2 pole 10 posizioni 10 positions		115 131	6 11	 <p>per / for GN63</p>
		11 131	5 10	 <p>per / for GX serie / series, GN12 - GN40, GN125</p>

Schemi commutatori a camme serie GX e GN

Circuit schemes rotary cam switches GX and GN series

Commutatori multivie con "0"

Multi-step switches with "0"

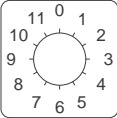
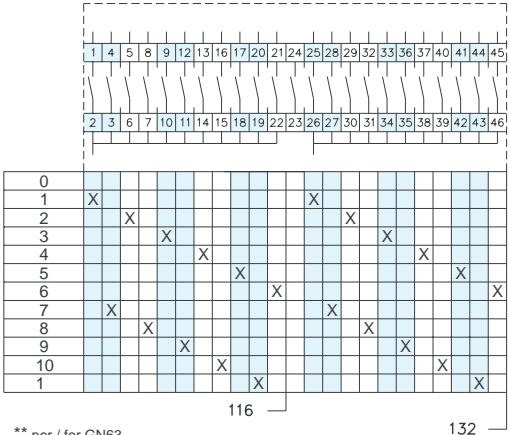
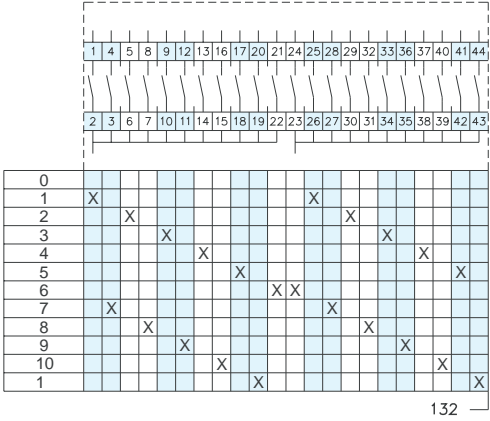
FUNZIONE FUNCTION	Mostrina Front plate	Schema Scheme	N° elem. N° of wafers	DIAGRAMMA / CONTACT CONFIGURATION
1 polo 1 pole 2 poli 2 pole 11 posizioni 11 positions		116 132**	6 12	 <p>** per / for GN63</p>
		132	11	 <p>per / for GX serie / series, GN12 - GN40, GN125</p>

Commutatori a gruppi

Gang switches

FUNZIONE FUNCTION	Mostrina Front plate	Schema Scheme	N° elem. N° of wafers	DIAGRAMMA / CONTACT CONFIGURATION																								
<p>2 GRUPPI Sequenza: 0, A, A+B 2 GANG Switching sequence: 0, A, A+B</p> <p>1 polo 1 pole</p>		251	1	<table border="1" style="margin-top: 10px;"> <tr><td>0</td><td></td><td></td><td></td><td></td></tr> <tr><td>1</td><td>X</td><td></td><td></td><td></td></tr> <tr><td>2</td><td>X</td><td>X</td><td></td><td></td></tr> </table>	0					1	X				2	X	X											
0																												
1	X																											
2	X	X																										
<p>3 GRUPPI Sequenza: 0, A, A+B, A+B+C 3 GANG Switching sequence: 0, A, A+B, A+B+C</p> <p>2 poli 2 pole</p>		252	2	<table border="1" style="margin-top: 10px;"> <tr><td>0</td><td></td><td></td><td></td><td></td></tr> <tr><td>1</td><td>X</td><td></td><td>X</td><td></td></tr> <tr><td>2</td><td>X</td><td>X</td><td>X</td><td>X</td></tr> </table>	0					1	X		X		2	X	X	X	X									
0																												
1	X		X																									
2	X	X	X	X																								
<p>3 GRUPPI Sequenza: 0, A, A+B, A+B+C 3 GANG Switching sequence: 0, A, A+B, A+B+C</p> <p>2 poli 2 pole</p>		255	3	<table border="1" style="margin-top: 10px;"> <tr><td>0</td><td></td><td></td><td></td><td></td><td></td></tr> <tr><td>1</td><td>X</td><td></td><td></td><td>X</td><td></td></tr> <tr><td>2</td><td>X</td><td>X</td><td></td><td>X</td><td>X</td></tr> <tr><td>3</td><td>X</td><td>X</td><td>X</td><td>X</td><td>X</td></tr> </table>	0						1	X			X		2	X	X		X	X	3	X	X	X	X	X
0																												
1	X			X																								
2	X	X		X	X																							
3	X	X	X	X	X																							

Schemi commutatori a camme serie GX e GN

Circuit schemes rotary cam switches GX and GN series

Commutatori a gruppi

Gang switches

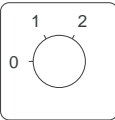
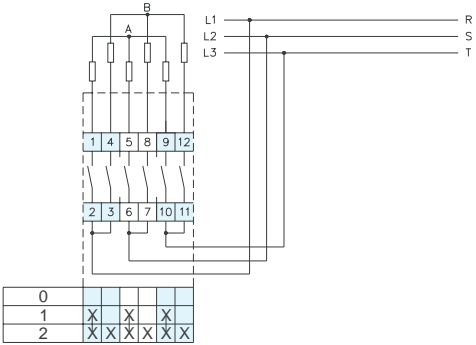
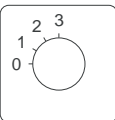
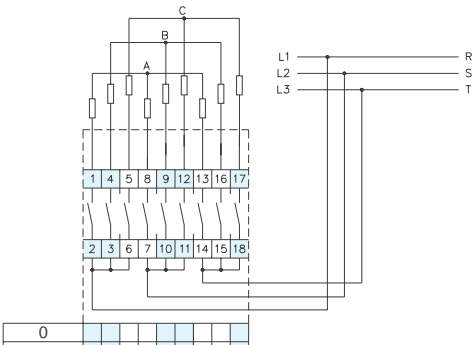
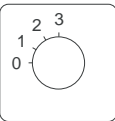
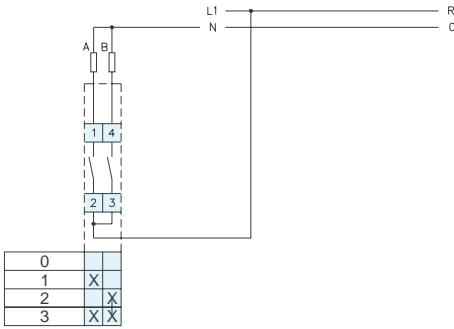
FUNZIONE FUNCTION	Mostrina Front plate	Schema Scheme	N° elem. N° of wafers	DIAGRAMMA / CONTACT CONFIGURATION																																																																
<p>2 GRUPPI Sequenza: 0, A, A+B 2 GANG Switching sequence: 0, A, A+B</p>		253	3	 <table border="1" data-bbox="948 645 1142 703"> <tr><td>0</td><td></td><td></td><td></td><td></td><td></td><td></td><td></td><td></td><td></td><td></td><td></td></tr> <tr><td>1</td><td>X</td><td></td><td>X</td><td></td><td>X</td><td></td><td></td><td></td><td></td><td></td><td></td></tr> <tr><td>2</td><td>X</td><td>X</td><td>X</td><td>X</td><td>X</td><td>X</td><td>X</td><td>X</td><td>X</td><td>X</td><td>X</td></tr> </table>	0												1	X		X		X							2	X	X	X	X	X	X	X	X	X	X	X																												
0																																																																				
1	X		X		X																																																															
2	X	X	X	X	X	X	X	X	X	X	X																																																									
<p>3 GRUPPI Sequenza: 0, A, A+B, A+B+C 3 GANG Switching sequence: 0, A, A+B, A+B+C</p>		256	5	 <table border="1" data-bbox="948 1077 1198 1158"> <tr><td>0</td><td></td><td></td><td></td><td></td><td></td><td></td><td></td><td></td><td></td><td></td><td></td><td></td><td></td><td></td><td></td></tr> <tr><td>1</td><td>X</td><td></td><td></td><td>X</td><td></td><td>X</td><td></td><td>X</td><td></td><td></td><td></td><td></td><td></td><td></td><td></td></tr> <tr><td>2</td><td>X</td><td>X</td><td>X</td><td>X</td><td>X</td><td>X</td><td>X</td><td>X</td><td>X</td><td>X</td><td>X</td><td>X</td><td>X</td><td>X</td><td>X</td></tr> <tr><td>3</td><td>X</td><td>X</td><td>X</td><td>X</td><td>X</td><td>X</td><td>X</td><td>X</td><td>X</td><td>X</td><td>X</td><td>X</td><td>X</td><td>X</td><td>X</td></tr> </table>	0																1	X			X		X		X								2	X	X	X	X	X	X	X	X	X	X	X	X	X	X	X	3	X	X	X	X	X	X	X	X	X	X	X	X	X	X	X
0																																																																				
1	X			X		X		X																																																												
2	X	X	X	X	X	X	X	X	X	X	X	X	X	X	X																																																					
3	X	X	X	X	X	X	X	X	X	X	X	X	X	X	X																																																					
<p>2 GRUPPI Sequenza: 0, A, B, A+B 2 GANG Switching sequence: 0, A, B, A+B</p>		257	1	 <table border="1" data-bbox="970 1473 1091 1554"> <tr><td>0</td><td></td><td></td></tr> <tr><td>1</td><td>X</td><td></td></tr> <tr><td>2</td><td></td><td>X</td></tr> <tr><td>3</td><td>X</td><td>X</td></tr> </table>	0			1	X		2		X	3	X	X																																																				
0																																																																				
1	X																																																																			
2		X																																																																		
3	X	X																																																																		

Commutatori a gruppi

Gang switches

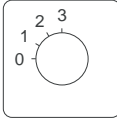
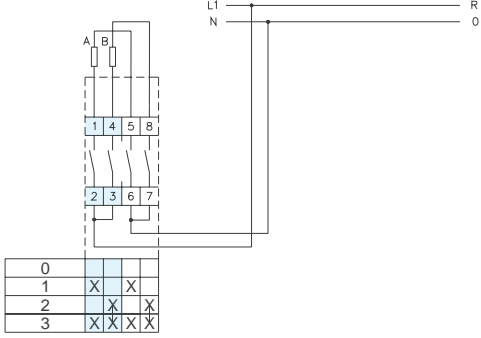
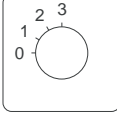
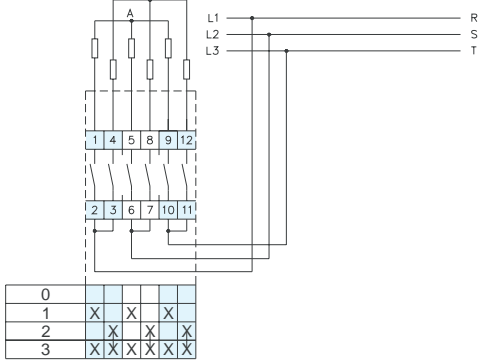
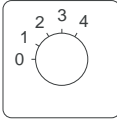
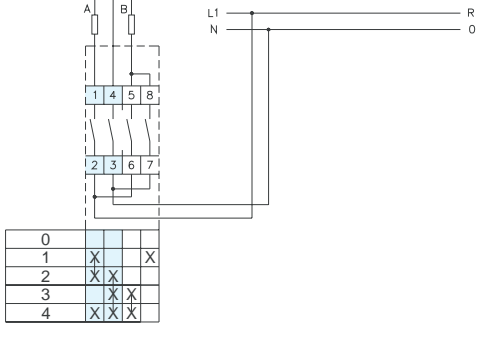
FUNZIONE FUNCTION	Mostrina Front plate	Schema Scheme	N° elem. N° of wafers	DIAGRAMMA / CONTACT CONFIGURATION																														
<p>2 GRUPPI Sequenza: 0, A, B, A+B 2 GANG Switching sequence: 0, A, B, A+B</p>		258	2	 <table border="1" data-bbox="1002 607 1161 689"> <tr><td>0</td><td></td><td></td><td></td><td></td></tr> <tr><td>1</td><td>X</td><td></td><td>X</td><td></td></tr> <tr><td>2</td><td></td><td>X</td><td>X</td><td>X</td></tr> <tr><td>3</td><td>X</td><td>X</td><td>X</td><td>X</td></tr> </table>	0					1	X		X		2		X	X	X	3	X	X	X	X										
0																																		
1	X		X																															
2		X	X	X																														
3	X	X	X	X																														
<p>3 poli 3 pole</p> <p>2 GRUPPI Sequenza: 0, A, B, A+B 2 GANG Switching sequence: 0, A, B, A+B</p>		259	3	 <table border="1" data-bbox="1002 1077 1161 1160"> <tr><td>0</td><td></td><td></td><td></td><td></td><td></td></tr> <tr><td>1</td><td>X</td><td></td><td>X</td><td>X</td><td></td></tr> <tr><td>2</td><td></td><td>X</td><td>X</td><td>X</td><td>X</td></tr> <tr><td>3</td><td>X</td><td>X</td><td>X</td><td>X</td><td>X</td></tr> </table>	0						1	X		X	X		2		X	X	X	X	3	X	X	X	X	X						
0																																		
1	X		X	X																														
2		X	X	X	X																													
3	X	X	X	X	X																													
<p>2 poli 2 pole</p> <p>2 GRUPPI Sequenza: 0, A+B serie, A, B, A+B parallelo 2 GANG Switching sequence: 0, A+B series, A, B, A+B parallel</p>		260	2	 <table border="1" data-bbox="1002 1469 1161 1574"> <tr><td>0</td><td></td><td></td><td></td><td></td><td></td></tr> <tr><td>1</td><td>X</td><td></td><td></td><td></td><td>X</td></tr> <tr><td>2</td><td>X</td><td>X</td><td></td><td></td><td></td></tr> <tr><td>3</td><td></td><td>X</td><td>X</td><td></td><td></td></tr> <tr><td>4</td><td>X</td><td>X</td><td>X</td><td></td><td></td></tr> </table>	0						1	X				X	2	X	X				3		X	X			4	X	X	X		
0																																		
1	X				X																													
2	X	X																																
3		X	X																															
4	X	X	X																															

Schemi commutatori a camme serie GX e GN

Circuit schemes rotary cam switches GX and GN series

Commutatori voltmetrici

Voltmeter switches

FUNZIONE FUNCTION	Mostrina Front plate	Schema Scheme	N° elem. N° of wafers	DIAGRAMMA / CONTACT CONFIGURATION																																								
3 tensioni di linea 1 tensione di fase 3 line voltage and 1 phase voltage		60	3	<table border="1"> <tr><td>L1N</td><td>X</td><td></td><td></td><td>X</td></tr> <tr><td>0</td><td>X</td><td></td><td></td><td></td></tr> <tr><td>L1L2</td><td>X</td><td></td><td>X</td><td></td></tr> <tr><td>L2L3</td><td>X</td><td>X</td><td>X</td><td></td></tr> <tr><td>L3L1</td><td>X</td><td>X</td><td></td><td></td></tr> </table>	L1N	X			X	0	X				L1L2	X		X		L2L3	X	X	X		L3L1	X	X																	
	L1N	X				X																																						
0	X																																											
L1L2	X		X																																									
L2L3	X	X	X																																									
L3L1	X	X																																										
		C 60	3																																									
3 tensioni di linea 3 tensioni di fase 3 line voltage and 3 phase voltage		66	3	<table border="1"> <tr><td>L3N</td><td>X</td><td></td><td></td><td>X</td></tr> <tr><td>L2N</td><td></td><td>X</td><td></td><td>X</td></tr> <tr><td>L1N</td><td></td><td></td><td></td><td>X</td><td>X</td></tr> <tr><td>0</td><td></td><td></td><td></td><td></td><td></td></tr> <tr><td>L1L2</td><td></td><td></td><td>X</td><td>X</td><td></td></tr> <tr><td>L2L3</td><td>X</td><td>X</td><td>X</td><td>X</td><td></td></tr> <tr><td>L3L1</td><td>X</td><td></td><td>X</td><td></td><td></td></tr> </table>	L3N	X			X	L2N		X		X	L1N				X	X	0						L1L2			X	X		L2L3	X	X	X	X		L3L1	X		X		
	L3N	X				X																																						
L2N		X		X																																								
L1N				X	X																																							
0																																												
L1L2			X	X																																								
L2L3	X	X	X	X																																								
L3L1	X		X																																									
		C 66	3																																									
3 tensioni di linea 3 line voltage		67	2	<table border="1"> <tr><td>0</td><td></td><td></td><td></td><td></td></tr> <tr><td>L1L2</td><td>X</td><td></td><td></td><td>X</td></tr> <tr><td>L2L3</td><td></td><td></td><td>X</td><td>X</td></tr> <tr><td>L3L1</td><td>X</td><td>X</td><td></td><td></td></tr> </table>	0					L1L2	X			X	L2L3			X	X	L3L1	X	X																						
	0																																											
L1L2	X			X																																								
L2L3			X	X																																								
L3L1	X	X																																										
		C 67	2																																									
3 tensioni di fase 3 phase voltage		68	2	<table border="1"> <tr><td>0</td><td></td><td></td><td></td><td></td></tr> <tr><td>L1N</td><td></td><td>X</td><td></td><td>X</td></tr> <tr><td>L2N</td><td>X</td><td></td><td></td><td>X</td></tr> <tr><td>L3N</td><td></td><td>X</td><td>X</td><td></td></tr> </table>	0					L1N		X		X	L2N	X			X	L3N		X	X																					
	0																																											
L1N		X		X																																								
L2N	X			X																																								
L3N		X	X																																									
		C 68	2																																									

**Commutatori
amperometrici**

Ammeter switches

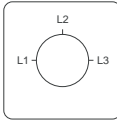
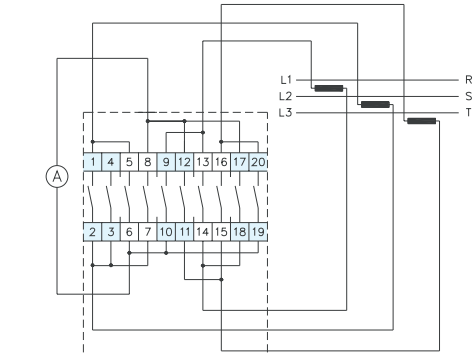
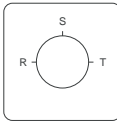
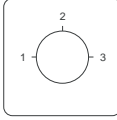
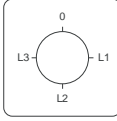
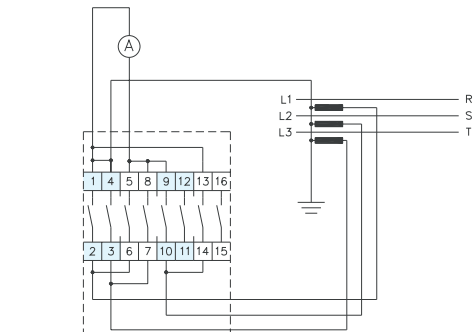
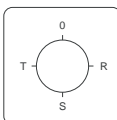
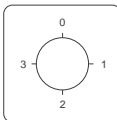
FUNZIONE FUNCTION	Mostrina Front plate	Schema Scheme	N° elem. N° of wafers	DIAGRAMMA / CONTACT CONFIGURATION																								
2 poli 3 correnti (con o senza trasformatore di corrente) 2 pole 3 currents (with or without current transformers)		58	5	 <table border="1" data-bbox="1007 757 1273 891"> <tr><td>L1</td><td>X</td><td></td><td>X</td><td></td><td>X</td><td>X</td></tr> <tr><td>L2</td><td></td><td>X</td><td>X</td><td></td><td></td><td></td></tr> <tr><td>L3</td><td>X</td><td></td><td></td><td>X</td><td>X</td><td>X</td></tr> </table>	L1	X		X		X	X	L2		X	X				L3	X			X	X	X			
	L1	X			X		X	X																				
	L2		X		X																							
L3	X			X	X	X																						
	C 58	5																										
	E 58	5																										
1 polo 3 correnti (con trasformatore di corrente) 1 pole 3 currents (with current transformer)		98	4	 <table border="1" data-bbox="1007 1330 1238 1554"> <tr><td>0</td><td>X</td><td>X</td><td></td><td></td><td>X</td></tr> <tr><td>L1</td><td>X</td><td>X</td><td></td><td></td><td>X</td></tr> <tr><td>L2</td><td>X</td><td>X</td><td></td><td>X</td><td></td></tr> <tr><td>L3</td><td>X</td><td></td><td>X</td><td></td><td>X</td></tr> </table>	0	X	X			X	L1	X	X			X	L2	X	X		X		L3	X		X		X
	0	X	X				X																					
	L1	X	X				X																					
L2	X	X		X																								
L3	X		X		X																							
	C 98	4																										
	E 98	4																										

Schemi commutatori a camme serie GX e GN

Circuit schemes rotary cam switches GX and GN series

Commutatori amperometrici

Ammeter switches

FUNZIONE FUNCTION	Mostrina Front plate	Schema Scheme	N° elem. N° of wafers	DIAGRAMMA / CONTACT CONFIGURATION																																
<p>2 poli posizione 0 3 correnti (con o senza trasformatore di corrente) 2 pole 0-position 3 currents (with or without current transformers)</p>		97	6	 <table border="1"> <tr><td>0</td><td></td><td>X</td><td>X</td><td></td><td></td><td></td><td>X</td></tr> <tr><td>L1</td><td>X</td><td></td><td>X</td><td>X</td><td></td><td></td><td>X</td></tr> <tr><td>L2</td><td></td><td>X</td><td>X</td><td></td><td>X</td><td></td><td>X</td></tr> <tr><td>L3</td><td>X</td><td>X</td><td></td><td>X</td><td></td><td></td><td>X</td></tr> </table> <p>per / for GN63</p>	0		X	X				X	L1	X		X	X			X	L2		X	X		X		X	L3	X	X		X			X
	0		X		X				X																											
	L1	X			X	X			X																											
	L2		X	X		X		X																												
	L3	X	X		X			X																												
		C 97	6																																	
	E 97	6																																		
<p>2 poli posizione 0 3 correnti (con o senza trasformatore di corrente) 2 pole 0-position 3 currents (with or without current transformers)</p>		97	5	 <table border="1"> <tr><td>0</td><td></td><td>X</td><td>X</td><td></td><td></td><td>X</td></tr> <tr><td>L1</td><td>X</td><td></td><td>X</td><td>X</td><td></td><td>X</td></tr> <tr><td>L2</td><td></td><td>X</td><td>X</td><td></td><td>X</td><td>X</td></tr> <tr><td>L3</td><td>X</td><td>X</td><td></td><td>X</td><td></td><td>X</td></tr> </table> <p>per / for GX serie / series, GN12 - GN40, GN125</p>	0		X	X			X	L1	X		X	X		X	L2		X	X		X	X	L3	X	X		X		X				
	0		X		X			X																												
	L1	X			X	X		X																												
L2		X	X		X	X																														
L3	X	X		X		X																														
	C 97	5																																		
	E 97	5																																		

**Commutatori
voltmetrici-
amperometrici**

**Voltmeter-ammeter
switches**

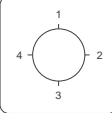
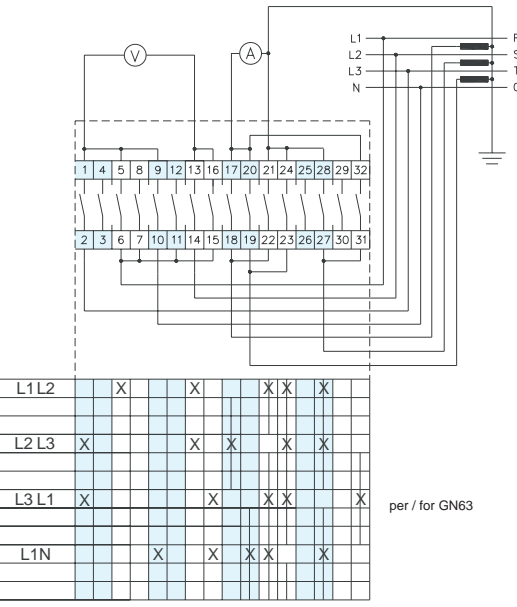
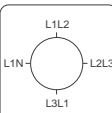
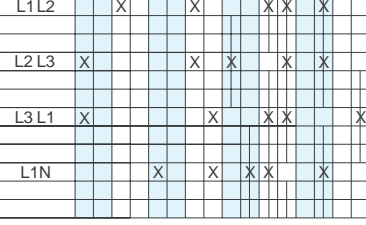
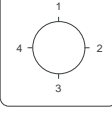
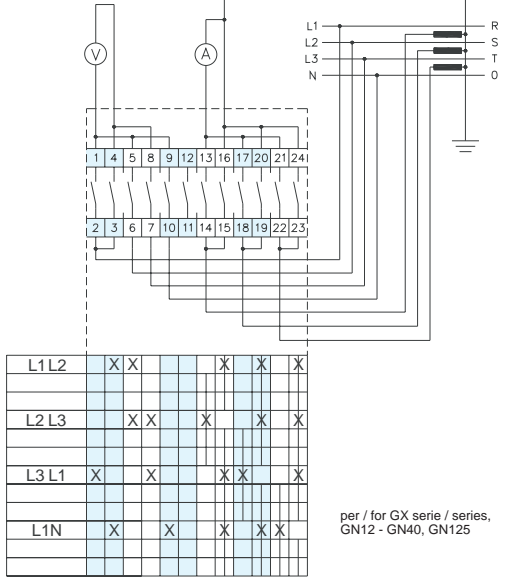
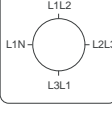
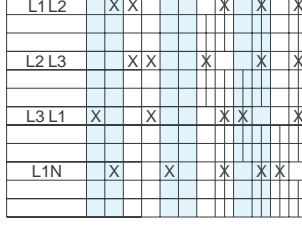
FUNZIONE FUNCTION	Mostrina Front plate	Schema Scheme	N° elem. N° of wafers	DIAGRAMMA / CONTACT CONFIGURATION															
3 tensioni di linea 1 tensione di fase 3 correnti 3 line voltage 1 phase voltage 3 current		61	8	 <p style="text-align: right;">per / for GN63</p>															
		C 61	8																
<table border="1" data-bbox="526 996 694 1120"> <thead> <tr> <th>Pos.</th> <th>Tensione Voltage</th> <th>Corrente Current</th> </tr> </thead> <tbody> <tr> <td>1</td> <td>L1L2</td> <td>—</td> </tr> <tr> <td>2</td> <td>L2L3</td> <td>L1</td> </tr> <tr> <td>3</td> <td>L3L1</td> <td>L2</td> </tr> <tr> <td>4</td> <td>L1N</td> <td>L3</td> </tr> </tbody> </table>	Pos.	Tensione Voltage	Corrente Current	1	L1L2	—	2	L2L3	L1	3	L3L1	L2	4	L1N	L3		61	6	 <p style="text-align: right;">per / for GX serie / series, GN12 - GN40, GN125</p>
	Pos.	Tensione Voltage	Corrente Current																
1	L1L2	—																	
2	L2L3	L1																	
3	L3L1	L2																	
4	L1N	L3																	
	C 61	6																	

Schemi commutatori a camme serie GX e GN

Circuit schemes rotary cam switches GX and GN series

Commutatori voltmetrici- amperometrici

Voltmeter-ammeter switches

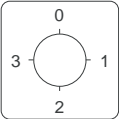
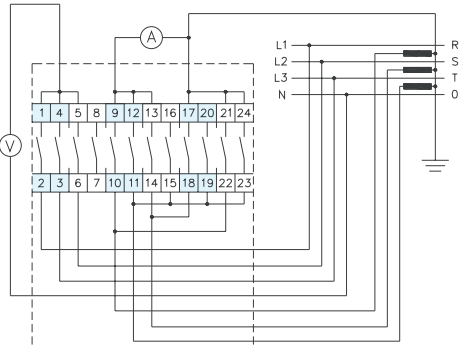
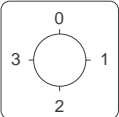
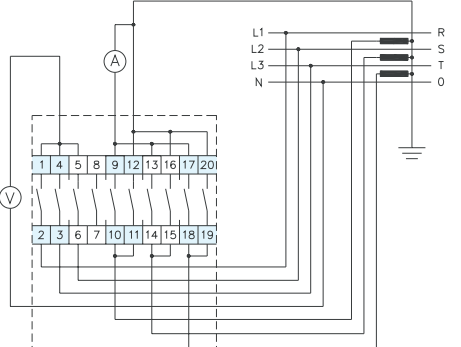
FUNZIONE FUNCTION	Mostrina Front plate	Schema Scheme	N° elem. N° of wafers	DIAGRAMMA / CONTACT CONFIGURATION																																											
<p>3 tensioni di fase 3 correnti 3 phase voltage 3 current</p> <table border="1" data-bbox="464 969 630 1086"> <thead> <tr> <th>Pos.</th> <th>Tensione Voltage</th> <th>Corrente Current</th> </tr> </thead> <tbody> <tr> <td>0</td> <td>—</td> <td>—</td> </tr> <tr> <td>1</td> <td>L1N</td> <td>L1</td> </tr> <tr> <td>2</td> <td>L2N</td> <td>L2</td> </tr> <tr> <td>3</td> <td>L3N</td> <td>L3</td> </tr> </tbody> </table>	Pos.	Tensione Voltage	Corrente Current	0	—	—	1	L1N	L1	2	L2N	L2	3	L3N	L3		64	6	 <table border="1" data-bbox="930 694 1236 918"> <tbody> <tr> <td>0</td> <td></td> <td></td> <td></td> <td>X</td> <td>X</td> <td>X</td> </tr> <tr> <td>1</td> <td>X</td> <td></td> <td>X</td> <td></td> <td>X</td> <td>X</td> </tr> <tr> <td>2</td> <td></td> <td>X</td> <td></td> <td>X</td> <td></td> <td>X</td> </tr> <tr> <td>3</td> <td>X</td> <td></td> <td>X</td> <td></td> <td>X</td> <td>X</td> </tr> </tbody> </table> <p>per / for GN63</p>	0				X	X	X	1	X		X		X	X	2		X		X		X	3	X		X		X	X
Pos.	Tensione Voltage	Corrente Current																																													
0	—	—																																													
1	L1N	L1																																													
2	L2N	L2																																													
3	L3N	L3																																													
0				X	X	X																																									
1	X		X		X	X																																									
2		X		X		X																																									
3	X		X		X	X																																									
		64	5	 <table border="1" data-bbox="930 1348 1198 1572"> <tbody> <tr> <td>0</td> <td></td> <td></td> <td></td> <td>X</td> <td>X</td> <td>X</td> </tr> <tr> <td>1</td> <td>X</td> <td></td> <td>X</td> <td></td> <td>X</td> <td>X</td> </tr> <tr> <td>2</td> <td></td> <td>X</td> <td></td> <td>X</td> <td>X</td> <td>X</td> </tr> <tr> <td>3</td> <td>X</td> <td></td> <td>X</td> <td></td> <td>X</td> <td>X</td> </tr> </tbody> </table> <p>per / for GX serie / series, GN12 - GN40, GN125</p>	0				X	X	X	1	X		X		X	X	2		X		X	X	X	3	X		X		X	X															
0				X	X	X																																									
1	X		X		X	X																																									
2		X		X	X	X																																									
3	X		X		X	X																																									

**Commutatori
voltmetrici-
amperometrici**

**Voltmeter-ammeter
switches**

FUNZIONE FUNCTION	Mostrina Front plate	Schema Scheme	N° elem. N° of wafers	DIAGRAMMA / CONTACT CONFIGURATION																																																																																																			
<p>3 tensioni di linea 3 correnti 3 line voltage 3 current</p> <table border="1"> <thead> <tr> <th>Pos.</th> <th>Tensione Voltage</th> <th>Corrente Current</th> </tr> </thead> <tbody> <tr> <td>0</td> <td>—</td> <td>—</td> </tr> <tr> <td>1</td> <td>L1L2</td> <td>L1</td> </tr> <tr> <td>2</td> <td>L2L3</td> <td>L2</td> </tr> <tr> <td>3</td> <td>L3L1</td> <td>L3</td> </tr> </tbody> </table>	Pos.	Tensione Voltage	Corrente Current	0	—	—	1	L1L2	L1	2	L2L3	L2	3	L3L1	L3		65	7	 <table border="1"> <tr><td>0</td><td></td><td></td><td></td><td></td><td></td><td></td><td></td><td></td><td></td><td></td><td></td><td></td><td></td><td></td><td></td><td></td><td></td><td>X</td><td>X</td><td>X</td></tr> <tr><td>1</td><td>X</td><td></td><td></td><td></td><td></td><td></td><td></td><td>X</td><td>X</td><td></td><td></td><td></td><td></td><td></td><td></td><td></td><td></td><td>X</td><td>X</td><td></td></tr> <tr><td>2</td><td></td><td>X</td><td></td><td></td><td></td><td></td><td></td><td>X</td><td>X</td><td></td><td></td><td></td><td></td><td></td><td></td><td></td><td></td><td>X</td><td>X</td><td>X</td></tr> <tr><td>3</td><td>X</td><td>X</td><td></td><td></td><td></td><td></td><td></td><td>X</td><td>X</td><td>X</td><td></td><td></td><td></td><td></td><td></td><td></td><td></td><td>X</td><td>X</td><td>X</td></tr> </table> <p>per / for GN63</p>	0																		X	X	X	1	X							X	X									X	X		2		X						X	X									X	X	X	3	X	X						X	X	X								X	X	X
	Pos.	Tensione Voltage	Corrente Current																																																																																																				
0	—	—																																																																																																					
1	L1L2	L1																																																																																																					
2	L2L3	L2																																																																																																					
3	L3L1	L3																																																																																																					
0																		X	X	X																																																																																			
1	X							X	X									X	X																																																																																				
2		X						X	X									X	X	X																																																																																			
3	X	X						X	X	X								X	X	X																																																																																			
		65	5	 <table border="1"> <tr><td>0</td><td></td><td></td><td></td><td></td><td></td><td></td><td></td><td></td><td></td><td></td><td></td><td></td><td></td><td></td><td></td><td></td><td></td><td>X</td><td>X</td><td>X</td></tr> <tr><td>1</td><td>X</td><td>X</td><td></td><td></td><td></td><td></td><td></td><td></td><td></td><td></td><td></td><td></td><td></td><td></td><td></td><td></td><td></td><td>X</td><td>X</td><td>X</td></tr> <tr><td>2</td><td></td><td>X</td><td>X</td><td></td><td></td><td></td><td></td><td></td><td></td><td></td><td></td><td></td><td></td><td></td><td></td><td></td><td></td><td>X</td><td>X</td><td>X</td></tr> <tr><td>3</td><td>X</td><td></td><td>X</td><td>X</td><td></td><td></td><td></td><td></td><td></td><td></td><td></td><td></td><td></td><td></td><td></td><td></td><td></td><td>X</td><td>X</td><td>X</td></tr> </table> <p>per / for GX serie / series, GN12 - GN40, GN125</p>	0																		X	X	X	1	X	X																X	X	X	2		X	X															X	X	X	3	X		X	X														X	X	X															
0																		X	X	X																																																																																			
1	X	X																X	X	X																																																																																			
2		X	X															X	X	X																																																																																			
3	X		X	X														X	X	X																																																																																			

Schemi commutatori a camme serie GX e GN

Circuit schemes rotary cam switches GX and GN series

Interruttori (con posizioni ad impulso)

Control switches (with spring return)

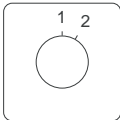
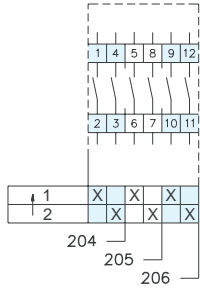
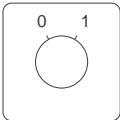
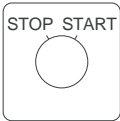
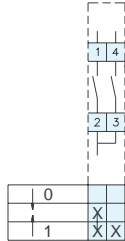
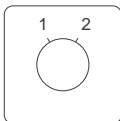
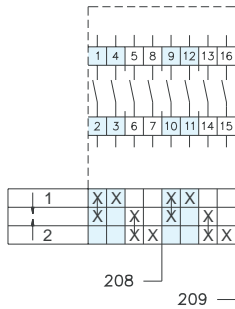
FUNZIONE FUNCTION	Mostrina Front plate	Schema Scheme	N° elem. N° of wafers	DIAGRAMMA / CONTACT CONFIGURATION
1 apertura e 1 chiusura 1 make and 1 break 2 aperture e 2 chiusure 2 makes and 2 breaks 3 aperture e 3 chiusure 3 makes and 3 breaks		204 205 206	1 2 3	
1 chiusura a destra e 1 apertura a sinistra 1 make right and 1 break left	 	207 C207	1 1	
1 chiusura, 1 apertura a destra 1 chiusura, 1 apertura a sinistra 1 make, 1 break right 1 make, 1 break left 2 chiusure, 2 aperture a destra 2 chiusure, 2 aperture a sinistra 2 makes, 2 breaks right 2 makes, 2 breaks left		208 209	2 4	

**Interruttori
(con posizioni ad impulso)**

**Control switches
(with spring return)**

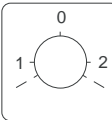
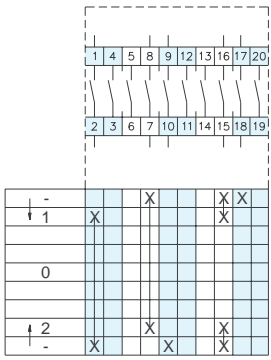
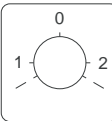
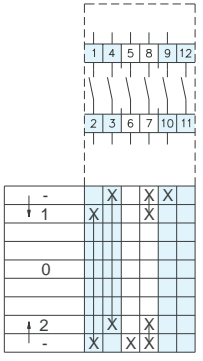
FUNZIONE FUNCTION	Mostrina Front plate	Schema Scheme	N° elem. N° of wafers	DIAGRAMMA / CONTACT CONFIGURATION
Interruttore con impulso di ritorno a sinistra e destra Switch with spring return left and right		210	5	 <p style="text-align: center;">per / for GN63</p>
		210	3	 <p style="text-align: center;">per / for GX serie / series GN12 - GN40, GN125</p>

Schemi commutatori a camme serie GX e GN

Circuit schemes rotary cam switches GX and GN series

Invertitori di marcia

Motor reversing switches

FUNZIONE FUNCTION	Mostrina Front plate	Schema Scheme	N° elem. N° of wafers	DIAGRAMMA / CONTACT CONFIGURATION												
3 poli 3 pole		11	3	<table border="1" style="margin-top: 10px;"> <tr><td>1</td><td>X</td><td>X</td><td>X</td></tr> <tr><td>0</td><td></td><td></td><td></td></tr> <tr><td>2</td><td>X</td><td></td><td>X</td></tr> </table>	1	X	X	X	0				2	X		X
	1	X	X		X											
	0															
2	X		X													
	C11	3														
	D11	3														
2 poli ritorno da 2 a "0" 2 pole return from 2 to "0"		14	2	<table border="1" style="margin-top: 10px;"> <tr><td>1</td><td>X</td><td></td><td>X</td></tr> <tr><td>0</td><td></td><td></td><td></td></tr> <tr><td>2</td><td>X</td><td>X</td><td></td></tr> </table>	1	X		X	0				2	X	X	
		1	X			X										
0																
2	X	X														
24	2															
2 poli 2 pole		24	2	<table border="1" style="margin-top: 10px;"> <tr><td>1</td><td>X</td><td></td><td>X</td></tr> <tr><td>0</td><td></td><td></td><td></td></tr> <tr><td>2</td><td>X</td><td>X</td><td></td></tr> </table>	1	X		X	0				2	X	X	
1	X		X													
0																
2	X	X														

Invertitori di marcia

Motor reversing switches

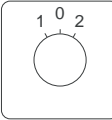
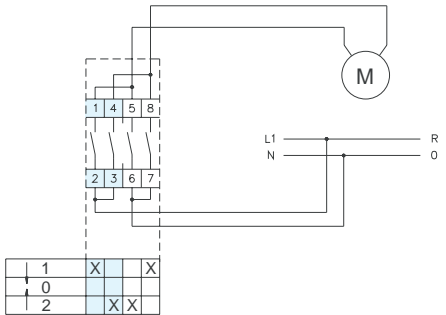
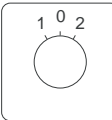
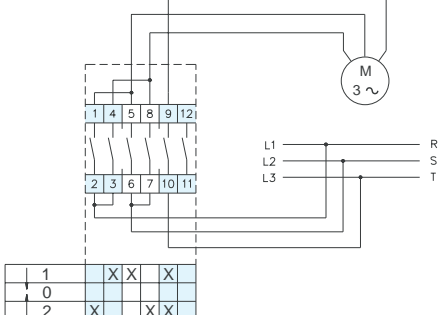
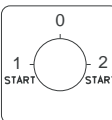
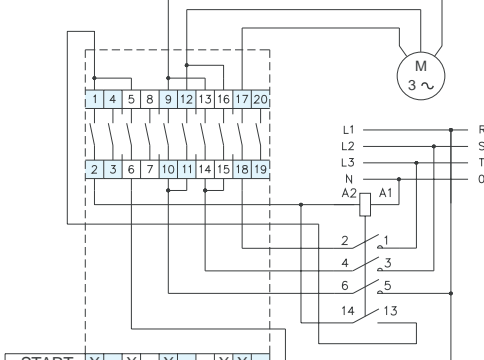
FUNZIONE FUNCTION	Mostrina Front plate	Schema Scheme	N° elem. N° of wafers	DIAGRAMMA / CONTACT CONFIGURATION																														
2 poli ritorno a "0" 2 pole return to "0"		25	2	 <table border="1" data-bbox="1018 591 1177 651"> <tr><td>1</td><td>X</td><td></td><td>X</td></tr> <tr><td>0</td><td></td><td></td><td></td></tr> <tr><td>2</td><td>X</td><td>X</td><td></td></tr> </table>	1	X		X	0				2	X	X																			
1	X		X																															
0																																		
2	X	X																																
3 poli ritorno a "0" 3 pole return to "0"		26	3	 <table border="1" data-bbox="1018 965 1214 1025"> <tr><td>1</td><td>X</td><td>X</td><td>X</td></tr> <tr><td>0</td><td></td><td></td><td></td></tr> <tr><td>2</td><td>X</td><td></td><td>X</td></tr> </table>	1	X	X	X	0				2	X		X																		
1	X	X	X																															
0																																		
2	X		X																															
3 poli con contattore 3 pole with contactor		27	5	 <table border="1" data-bbox="1018 1424 1289 1592"> <tr><td>START</td><td>X</td><td>X</td><td>X</td><td>X</td><td>X</td></tr> <tr><td>1</td><td></td><td></td><td></td><td></td><td></td></tr> <tr><td>0</td><td></td><td></td><td></td><td></td><td></td></tr> <tr><td>2</td><td></td><td>X</td><td>X</td><td>X</td><td>X</td></tr> <tr><td>START</td><td>X</td><td>X</td><td>X</td><td>X</td><td>X</td></tr> </table>	START	X	X	X	X	X	1						0						2		X	X	X	X	START	X	X	X	X	X
START	X	X	X	X	X																													
1																																		
0																																		
2		X	X	X	X																													
START	X	X	X	X	X																													

Schemi commutatori a camme serie GX e GN

Circuit schemes rotary cam switches GX and GN series

Commutatori stella-triangolo

Star-delta switches

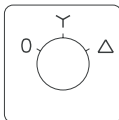
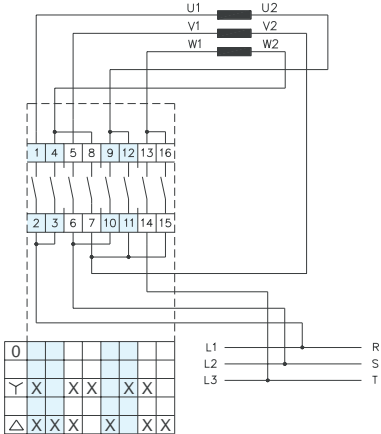
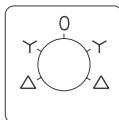
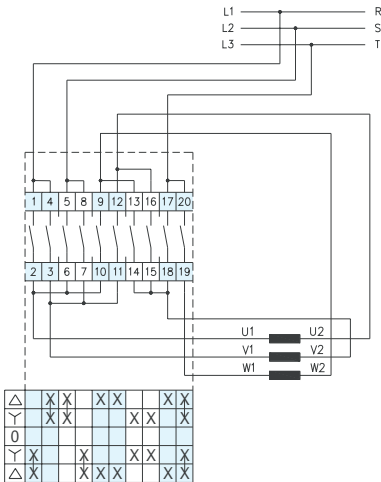
FUNZIONE FUNCTION	Mostrina Front plate	Schema Scheme	N° elem. N° of wafers	DIAGRAMMA / CONTACT CONFIGURATION
Versione standard Standard version		12	4	
Invertitore di marcia Reversing		21	5	

Commutatori stella-triangolo

Star-delta switches

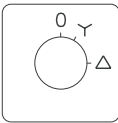
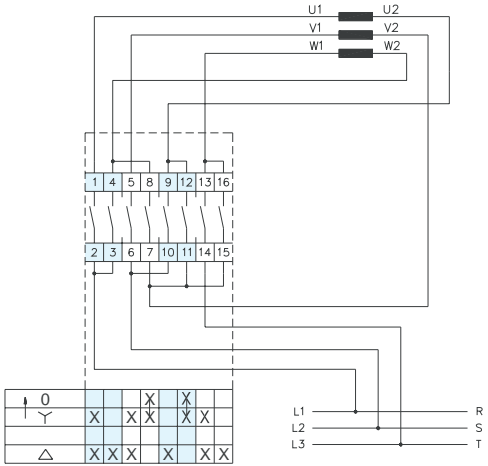
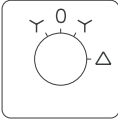
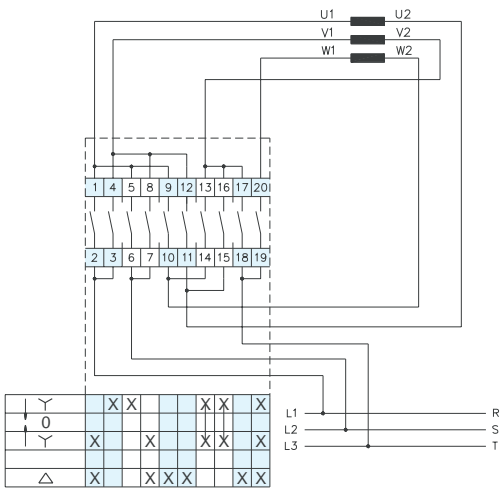
FUNZIONE FUNCTION	Mostrina Front plate	Schema Scheme	N° elem. N° of wafers	DIAGRAMMA / CONTACT CONFIGURATION
<p>Ritorno da "Y" a "0" Return from "Y" to "0"</p>		28	4	
<p>Frenatura in controcorrente Counter current braking</p>		29	5	

Commutatori di polarità (Dahlander)

Motor control switches (Dahlander)

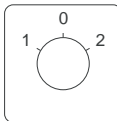
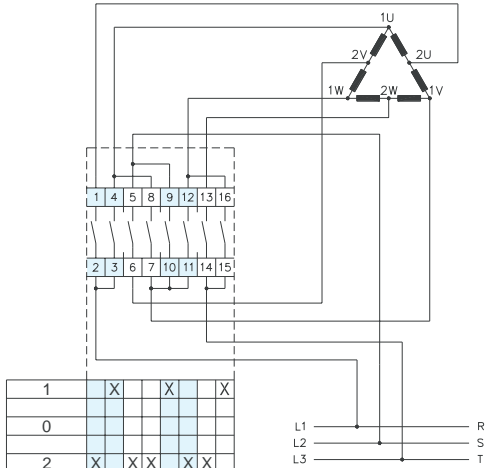
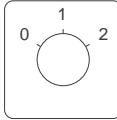
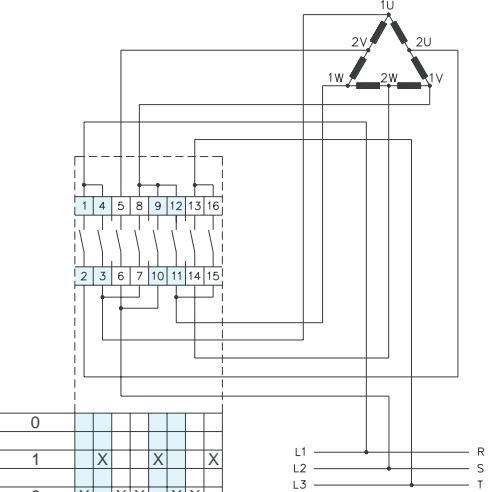
FUNZIONE FUNCTION	Mostrina Front plate	Schema Scheme	N° elem. N° of wafers	DIAGRAMMA / CONTACT CONFIGURATION																		
<p>Con "0" centrale (Δ - 0 - YY)</p> <p>With center "0" (Δ - 0 - YY)</p>		13	4	 <table border="1" data-bbox="991 786 1225 875"> <tr> <td>1</td> <td>X</td> <td></td> <td>X</td> <td></td> <td>X</td> </tr> <tr> <td>0</td> <td></td> <td></td> <td></td> <td></td> <td></td> </tr> <tr> <td>2</td> <td>X</td> <td>X</td> <td>X</td> <td>X</td> <td>X</td> </tr> </table>	1	X		X		X	0						2	X	X	X	X	X
1	X		X		X																	
0																						
2	X	X	X	X	X																	
<p>Versione standard (0 - Δ - YY)</p> <p>Standard version (0 - Δ - YY)</p>		19	4	 <table border="1" data-bbox="991 1435 1225 1525"> <tr> <td>0</td> <td></td> <td></td> <td></td> <td></td> <td></td> </tr> <tr> <td>1</td> <td>X</td> <td></td> <td>X</td> <td></td> <td>X</td> </tr> <tr> <td>2</td> <td>X</td> <td>X</td> <td>X</td> <td>X</td> <td>X</td> </tr> </table>	0						1	X		X		X	2	X	X	X	X	X
0																						
1	X		X		X																	
2	X	X	X	X	X																	

Commutatori per motori (avvolgimenti separati)

Motor control switches (separate windings)

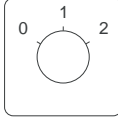
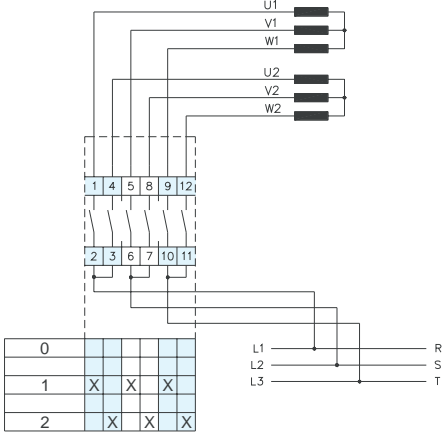
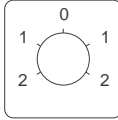
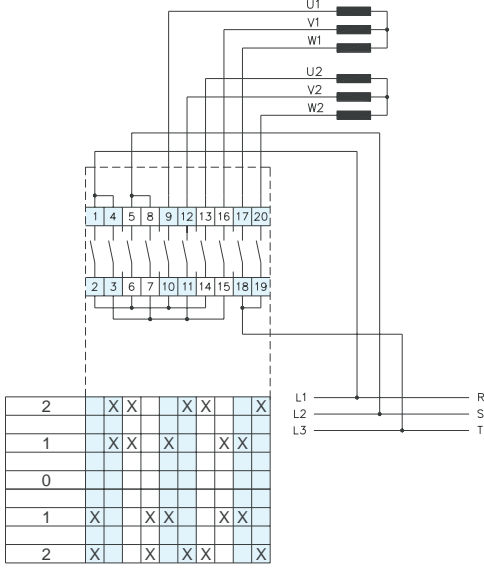
FUNZIONE FUNCTION	Mostrina Front plate	Schema Scheme	N° elem. N° of wafers	DIAGRAMMA / CONTACT CONFIGURATION																																																		
<p>2 velocità, 2 avvolgimenti 2 speed, 2 winding</p>		22	3	 <table border="1" data-bbox="1023 741 1219 837"> <tr><td>0</td><td></td><td></td><td></td><td></td><td></td></tr> <tr><td>1</td><td>X</td><td></td><td>X</td><td></td><td>X</td></tr> <tr><td>2</td><td></td><td>X</td><td></td><td>X</td><td>X</td></tr> </table>	0						1	X		X		X	2		X		X	X																																
0																																																						
1	X		X		X																																																	
2		X		X	X																																																	
<p>2 velocità, 2 commutazioni 2 avvolgimenti 2 speed, reversing, 2 windings</p>		23	5	 <table border="1" data-bbox="1007 1379 1278 1554"> <tr><td>2</td><td></td><td>X</td><td>X</td><td></td><td></td><td>X</td><td>X</td><td></td><td>X</td></tr> <tr><td>1</td><td></td><td>X</td><td>X</td><td></td><td>X</td><td></td><td></td><td>X</td><td>X</td></tr> <tr><td>0</td><td></td><td></td><td></td><td></td><td></td><td></td><td></td><td></td><td></td></tr> <tr><td>1</td><td>X</td><td></td><td></td><td>X</td><td>X</td><td></td><td></td><td>X</td><td>X</td></tr> <tr><td>2</td><td>X</td><td></td><td></td><td>X</td><td>X</td><td></td><td></td><td>X</td><td>X</td></tr> </table>	2		X	X			X	X		X	1		X	X		X			X	X	0										1	X			X	X			X	X	2	X			X	X			X	X
2		X	X			X	X		X																																													
1		X	X		X			X	X																																													
0																																																						
1	X			X	X			X	X																																													
2	X			X	X			X	X																																													

Schemi commutatori a camme serie GX e GN

Circuit schemes rotary cam switches GX and GN series

Commutatori per motori (avvolgimenti separati)

Motor control switches (separate windings)

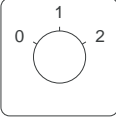
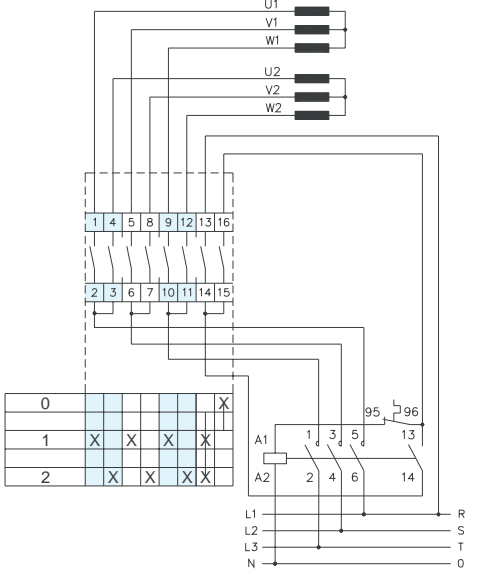
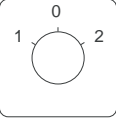
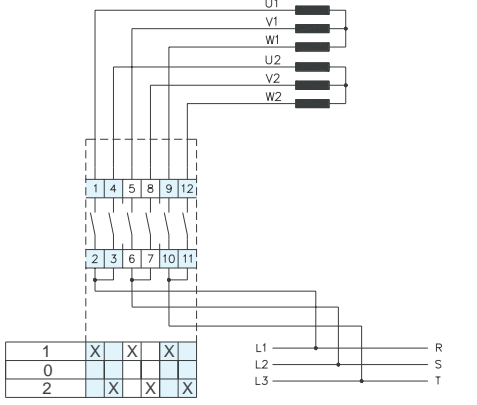
FUNZIONE FUNCTION	Mostrina Front plate	Schema Scheme	N° elem. N° of wafers	DIAGRAMMA / CONTACT CONFIGURATION																																																		
<p>2 velocità, 2 avvolgimenti con contattore 2 speed, 2 winding with contactor</p>		33	4	 <table border="1" data-bbox="965 761 1197 862"> <tr> <td>0</td> <td></td> <td></td> <td></td> <td></td> <td></td> <td></td> <td></td> <td></td> <td></td> <td></td> <td></td> <td></td> <td></td> <td></td> <td>X</td> </tr> <tr> <td>1</td> <td>X</td> <td>X</td> <td>X</td> <td>X</td> <td>X</td> <td></td> <td></td> <td></td> <td></td> <td></td> <td></td> <td></td> <td></td> <td></td> <td></td> <td></td> </tr> <tr> <td>2</td> <td></td> <td>X</td> <td>X</td> <td>X</td> <td>X</td> <td>X</td> <td></td> <td></td> <td></td> <td></td> <td></td> <td></td> <td></td> <td></td> <td></td> <td></td> </tr> </table>	0															X	1	X	X	X	X	X												2		X	X	X	X	X										
0															X																																							
1	X	X	X	X	X																																																	
2		X	X	X	X	X																																																
<p>2 velocità, 2 avvolgimenti 2 speed, 2 winding</p>		53	3	 <table border="1" data-bbox="965 1422 1165 1489"> <tr> <td>1</td> <td>X</td> <td>X</td> <td>X</td> <td></td> <td></td> <td></td> <td></td> <td></td> <td></td> <td></td> <td></td> <td></td> <td></td> <td></td> <td></td> </tr> <tr> <td>0</td> <td></td> <td></td> <td></td> <td></td> <td></td> <td></td> <td></td> <td></td> <td></td> <td></td> <td></td> <td></td> <td></td> <td></td> <td></td> </tr> <tr> <td>2</td> <td></td> <td>X</td> <td>X</td> <td>X</td> <td></td> <td></td> <td></td> <td></td> <td></td> <td></td> <td></td> <td></td> <td></td> <td></td> <td></td> </tr> </table>	1	X	X	X													0																2		X	X	X													
1	X	X	X																																																			
0																																																						
2		X	X	X																																																		

Invertitori di marcia con fase ausiliaria

Start and run switches

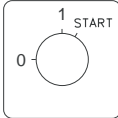
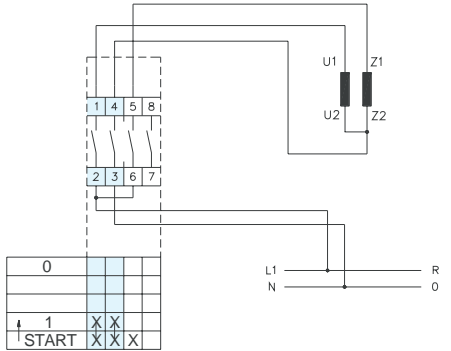
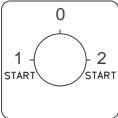
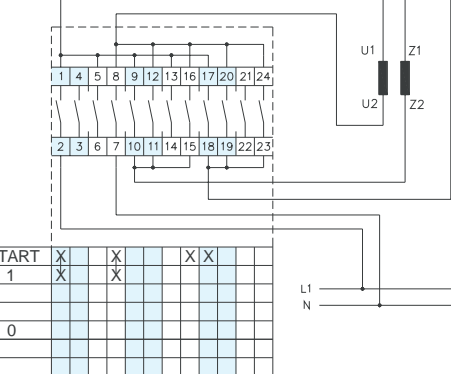
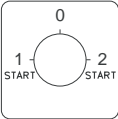
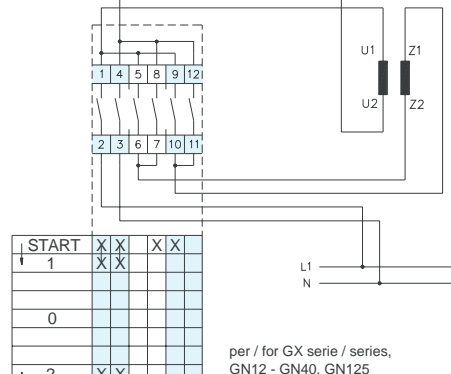
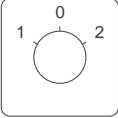
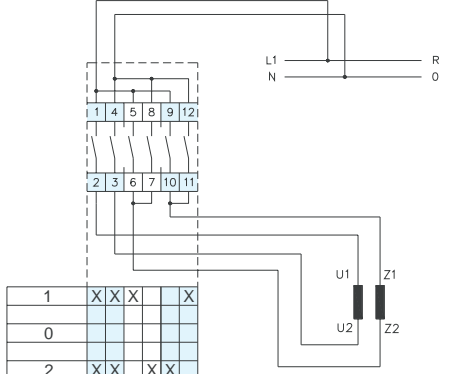
FUNZIONE FUNCTION	Mostrina Front plate	Schema Scheme	N° elem. N° of wafers	DIAGRAMMA / CONTACT CONFIGURATION
Versione standard Standard version		15	2	
Invertitore di marcia Reversing		16	6	 <p>per / for GN63</p>
		16	3	 <p>per / for GX serie / series, GN12 - GN40, GN125</p>
Invertitore di marcia con avvolgimento di avviamento permanente Reversing permanent start winding		17	3	

Dimensioni (mm) / Dimensions [mm]

Commutatori a camme, serie GX

Rotary cam switches, GX series

Montaggio frontale / Front mounting

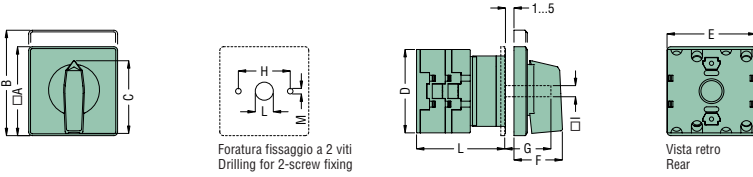

Tipo Type	Dimensioni / Dimensions											L [mm]					
	A	B	C	D	E	F	G	H	I	L	M	1 elem. 1 wafer	2 elem. 2 wafers	3 elem. 3 wafers	4 elem. 4 wafers	5 elem. 5 wafers	6 elem. 6 wafers
GX16 U	48	—	39.5	45	48	26.5	23.5	28	6	12	5	42.5	51	59.5	68	76.5	85
GX16 U25	48	60	●	45	48	34	23.5	28	6	12	5	39.5	48	56.5	65	73.5	82
GX20 U	48	—	39.5	45	48	26.5	23.5	28	6	12	5	42.5	51	59.5	68	76.5	85
GX20 U25	48	60	●	45	48	34	23.5	28	6	12	5	39.5	48	56.5	65	73.5	82
GX32 U	65	—	53	58	66	34.5	26	28	7	14	5	47.5	59.5	71.5	83.5	95.5	107.5
GX32 U25	65	80	●	58	66	38	26	28	7	14	5	48	60	72	84	96	108
GX40 U	65	—	53	58	66	34.5	26	28	7	14	5	47.5	59.5	71.5	83.5	95.5	107.5
GX40 U25	65	80	●	58	66	38	26	28	7	14	5	48	60	72	84	96	108

● Manopola lucchettabile / Padlockable handle.

Montaggio blocco-porta esecuzione O / Door coupling O version

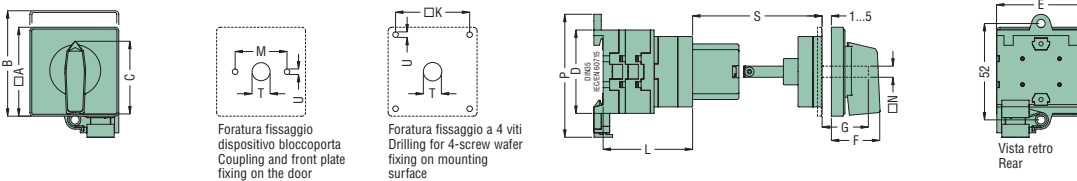

Tipo Type	Dimensioni / Dimensions														L [mm]					
	A	C	D	E	F	G	K	M	N	O	P	S	T	U	1 elem. 1 wafer	2 elem. 2 wafers	3 elem. 3 wafers	4 elem. 4 wafers	5 elem. 5 wafers	6 elem. 6 wafers
GX16 O	48	39.5	45	48	26.5	23.5	—	28	6	52	66.5	48-58	12	5	40	48.5	57	65.5	74	82.5
GX16 O88	48	●	45	48	34	23.5	36	—	6	52	66.5	45-55	12	5	40	48.5	57	65.5	74	82.5
GX20 O	48	39.5	45	48	26.5	23.5	—	28	6	52	66.5	48-58	12	5	40	48.5	57	65.5	74	82.5
GX20 O88	48	●	45	48	34	23.5	36	—	6	52	66.5	45-55	12	5	40	48.5	57	65.5	74	82.5
GX32 O	65	53	58	66	34.5	26	—	28	7	68	78	48-58	14	5	48.7	60.7	72.7	84.7	96.7	108.7
GX32 O88	65	●	58	66	38	26	48	—	7	68	78	45-55	14	5	48.7	60.7	72.7	84.7	96.7	108.7
GX40 O	65	53	58	66	34.5	26	—	28	7	68	78	48-58	14	5	48.7	60.7	72.7	84.7	96.7	108.7
GX40 O98	65	●	58	66	38	26	48	—	7	68	78	45-55	14	5	48.7	60.7	72.7	84.7	96.7	108.7

● Manopola lucchettabile / Padlockable handle.

Montaggio in cassetta / Mounting in enclosure

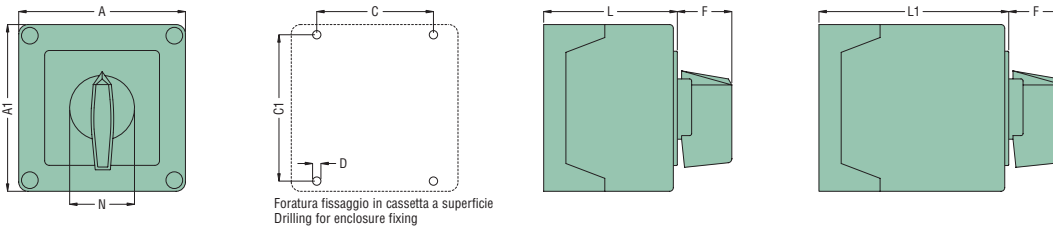

Tipo Type	Numero elementi Number of wafers	Dimensioni cassetta Enclosure size	A	A1	C	C1	D	F	M	N	L	L1	Protezione Protection degree	Pressacavi R Cable glands R
GX16	1-2	90x90	90	90	79	63	4.5	25	19	30	71.3	98.3	IP65	4xPG 16
GX20	1-2	90x90	90	90	79	63	4.5	25	19	30	71.3	98.3	IP65	4xPG 16
GX32	1-2	110x110	110	110	98.4	83	4.5	32	21	39.5	85.5	119.5	IP65	4xPG 21
GX40	1-2	110x110	110	110	98.4	83	4.5	32	21	39.5	85.5	119.5	IP65	4xPG 21

Montaggio frontale Ø22mm / Front mounting Ø22mm

Montaggio frontale Ø22mm / Front mounting Ø22mm

Montaggio modulare / Modular mounting

Tipo Type	L [mm]				Tipo Type	L [mm]				Tipo Type	L [mm]	
	1 elemento 1 wafer	2 elementi 2 wafers	3 elementi 3 wafers	4 elementi 4 wafers		1 elemento 1 wafer	2 elementi 2 wafers	3 elementi 3 wafers	4 elementi 4 wafers		3 elementi 3 wafers	4 elementi 4 wafers
GX16	35	43.5	52	60.5	GX16	35	43.5	52	60.5	GX16	50	58.5

Dimensioni (mm) / Dimensions [mm]

Commutatori a camme, serie GN Rotary cam switches, GN series

Montaggio frontale / Front mounting

Fissaggio mostrina e elementi
Front plate and wafer fixing

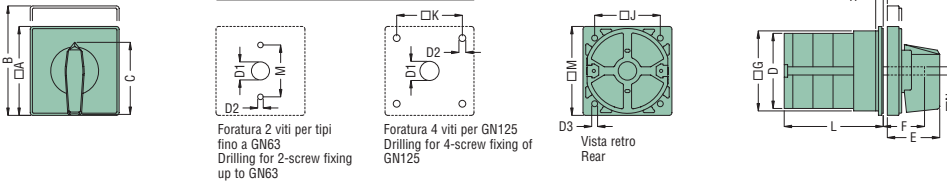

Foratura 2 viti per tipi fino a GN63
Drilling for 2-screw fixing up to GN63

Foratura 4 viti per GN125
Drilling for 4-screw fixing of GN125

Vista retro
Rear

Tipo Type	Dimensioni / Dimensions														L						
	□ A	B	C	D	D1	D2	D3	E	F	Ø G	H	□ J	□ K	□ M	□ N	1 elem. 1 wafer	2 elem. 2 wafers	3 elem. 3 wafers	4 elem. 4 wafers	5 elem. 5 wafers	6 elem. 6 wafers
GN12	48	60	39.5	38	12	5	4.3	26.5	23.5	38	5	36	36	48	6	32.5	42.1	51.7	61.3	70.9	80.5
GN12Δ	65	80	53	38	14	5	4.3	34.5	26	58.5	5.5	48	48	65	7	39.2	48.8	58.4	68	77.6	87.2
GN20	48	60	39.5	39	12	5	4.3	26.5	23.5	38	5	36	36	48	6	33.1	42.8	52.5	62.2	71.9	81.6
GN20Δ	65	80	53	39	14	5	4.3	34.5	26	58.5	5.5	48	48	65	7	39.8	49.5	59.2	68.9	78.6	88.3
GN25	48	60	39.5	43	12	5	4.3	26.5	23.5	38	5	36	36	48	6	37.5	51.1	64.7	78.2	91.9	105.5
GN25Δ	65	80	53	43	14	5	4.3	34.5	20	58.5	5.5	48	48	65	7	44.2	57.8	71.4	85	98.6	112.2
GN32	65	80	53	56	14	5	4.3	34.5	26	58.5	5.5	48	48	65	7	40.9	54.5	68.1	81.7	95.3	108.9
GN40	65	80	53	58	14	5	4.3	34.5	26	58.5	5.5	48	48	65	7	43.5	58.6	73.7	88.8	103.9	119
GN63	65	80	53	62	14	5	4.3	34.5	26	58.5	5.5	48	68	65	7	47.3	65.4	83.5	101.6	119.7	137.8
GN125	90	110	70.5	86	16	6	5.3	41.5	28	84	7.5	68	68	90	9	67.3	96.4	125.5	154.6	183.7	212.8

Δ Dimensioni per esecuzioni U06 e U25 / Dimensions for U06 and U25 versions

Montaggio blocco-porta / Door coupling O version

Fissaggio mostrina e elementi
Front plate and wafer fixing

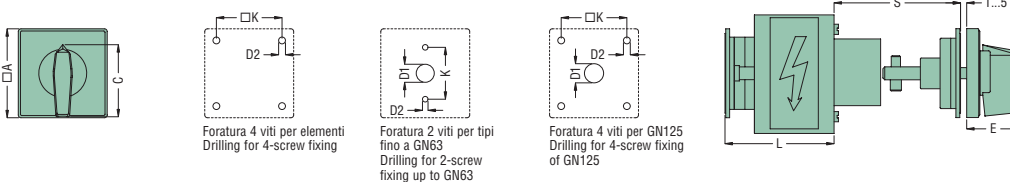

Foratura 4 viti per elementi fino a GN63
Drilling for 4-screw fixing up to GN63

Foratura 2 viti per tipi fino a GN63
Drilling for 2-screw fixing up to GN63

Foratura 4 viti per GN125
Drilling for 4-screw fixing of GN125

Tipo Type	Dimensioni / Dimensions							L			
	□ A	C	D1	D2	E	□ K	S	1 elem. 1 wafer	2 elem. 2 wafers	3 elem. 3 wafers	4 elem. 4 wafers
GN12-088	65	53	14	5	34.5	48	45-55	37.58	47.1	56.7	66.3
GN20-088	65	53	14	5	34.5	48	45-55	38.1	47.8	57.5	67.2
GN25-088	65	53	14	5	34.5	48	45-55	42.5	56.1	65.7	83.2
GN12-068	48	39.5	12	5	26.5	36	45-55	37.5	47.1	56.7	66.3
GN20-068	48	39.5	12	5	26.5	36	45-55	38.1	47.8	57.5	67.2
GN25-068	48	39.5	12	5	26.5	36	45-55	42.5	56.1	65.7	83.2
GN32	65	53	14	5	34.5	48	45-55	49.2	62.8	76.4	90
GN40	65	53	14	5	34.5	48	45-55	45.9	59.5	73.1	86.7
GN63	65	53	14	5	34.5	48	45-55	54.3	72.4	90.5	108.6
GN125	90	70.5	16	6	41.5	68	45-55	74.8	103.9	133	162.1

Montaggio in cassetta / Mounting in enclosure

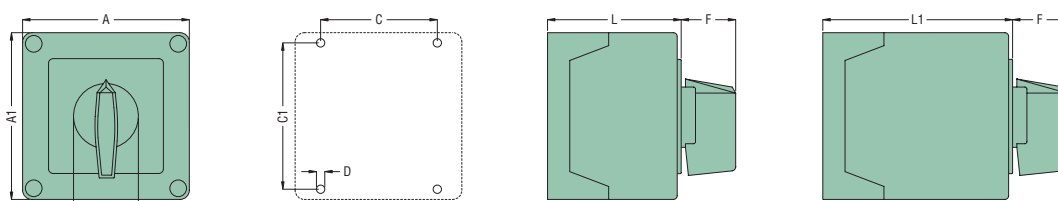

Foratura fissaggio in cassetta a superficie
Drilling for enclosure fixing

Tipo Type	Numero elementi Number of wafers	Dimensioni cassetta Enclosure size	L										Protezione Protection degree	Pressacavi R Cable glands R	
			A	A1	C	C1	D	F	M	N	L	L1			
GN12	1-2	3-4	65x65	65	65	54	38	4.3	19	13	25	55.5	75	IP54	4xPG 11
GN12 GN20 GN25	1-2 1-2 1	3-4 3-4 2-3	75x75	75	75	64	50	4.5	19	14	28	57.5	79.8	IP65	4xPG 13.5
GN20 GN25 GN32 GN40	1-3 1-2 1-2 1	4-6 3-4 3-4 2-3	90x90	90	90	63	79	4.5	25	19	30	71.3	98.3	IP65	4xPG 16
GN32 GN40 GN63	1-3 1-2 1-2	4-5 3-4 3-4	110x110	125	175	112	146	5.5	32	21	68	84.3	118.3	IP65	4xPG 21

Montaggio frontale Ø22mm / Front mounting Ø22mm

Montaggio frontale Ø22mm / Front mounting Ø22mm

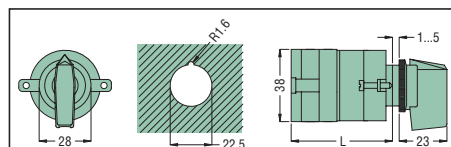
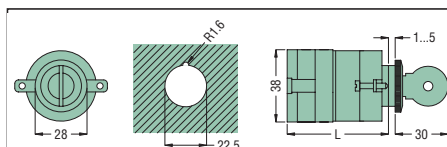

Tipo Type	L [mm]			
	1 elemento 1 wafer	2 elementi 2 wafers	3 elementi 3 wafers	4 elementi 4 wafers
GN12	41.5	51.1	60.7	70.3
GN20	42.1	51.8	61.5	71.2
GN25	46.5	60.1	73.7	87.3

Tipo Type	L [mm]			
	1 elemento 1 wafer	2 elementi 2 wafers	3 elementi 3 wafers	4 elementi 4 wafers
GN12	41.5	51.1	60.7	70.3
GN20	42.5	51.8	61.5	71.2
GN25	46.5	60.1	73.7	87.3

GUIDA ALLA SCELTA

La scelta del commutatore e il suo dimensionamento devono fare riferimento, oltre che allo schema funzionale, al tipo di impiego previsto.

Le norme IEC forniscono una chiara e rapida classificazione delle varie categorie d'impiego riscontrabili più frequentemente:

AC1: Inserzione e disinserzione di carichi resistivi ($\cos\varphi \geq 0,95$)

AC21: Forni a resistenze

AC3: Inserzione e disinserzione di motori

AC23: Inserzione e disinserzione di carichi fortemente induttivi

AC15: Comando di circuiti ausiliari, elettromagneti.

Per applicazioni in corrente continua i commutatori sono utilizzati per l'inserzione e la disinserzione di carichi minori o in circuiti di comando, quali:

DC13: Comando di elettromagneti in corrente continua

DC21: Manovra di carichi resistivi con sovraccarichi di modesta entità (DC21A è per utilizzo con operazioni frequenti).

DC23: Manovra di carichi altamente induttivi (DC23A è per utilizzo con operazioni frequenti).

Ulteriori prescrizioni e raccomandazioni sull'utilizzo dei commutatori per l'equipaggiamento delle macchine elettriche sono dettate dalle normative IEC/EN 60204-1, e più precisamente quanto indicato alla voce impieghi.

IMPIEGHI

INTERRUTTORE GENERALE CON FUNZIONI DI EMERGENZA:

- manopola di colore rosso su sfondo giallo
- lucchettabile in posizione di aperto.

INTERRUTTORE DI EMERGENZA:

- manopola di colore rosso su sfondo giallo
- funzionamento indipendente e prevalente sulle altre funzioni
- la portata nominale deve tener conto della somma delle correnti nominali di esercizio di tutte le apparecchiature
- potere d'interruzione pari alla corrente motore a rotore bloccato più la corrente totale assorbita da altri carichi presenti.

INTERRUTTORE GENERALE CON FUNZIONI DI SEZIONAMENTO:

- utilizzato per separare l'apparecchiatura dalla rete di alimentazione
- distanza in aria dei contatti rispondente alla norma IEC/EN 60947-3
- possibilità di blocco con lucchetto in posizione di aperto
- dimensionamento per interruzione di correnti previste dalle categorie AC1 e AC21.

Caratteristiche di impiego

SERIE		GX				GN								
TIPO		GX16	GX20	GX32	GX40	GN12	GN20	GN25	GN32	GN40	GN63	GN125		
Tensione nominale di isolamento ^① Ui IEC/EN UL/CSA	V	690	690	690	690	690	690	690	690	690	690	690		
	V	600	600	600	600	300	300	600	600	600	600	600		
Tensione nominale di tenuta ad impulso ^① Uimp IEC/EN 60947-3	kV	6	6	6	6	6	6	6	6	6	6	8		
Corrente termica nominale Ith IEC/EN UL/CSA (general purpose)	A	16	20	32	40	12	20	25	32	40	63	125		
	A	12	15	32	40	12	15	20	32	35	55	100		
Tensione nominale di impiego (interruttore sezionatore) ^①	V	440	440	440	440	480	480	480	480	480	480	690		
Tensione nominale di tenuta a impulso (interruttore sezionatore)	kV	4	4	4	4	4	4	4	4	4	4	6		
Max. calibro fusibili per protezione da corto circuito In (gG)	10kA	A	20	20	40	40	16	20	25	32	40	63	125	
	25kA	A	16	16	35	35	10	16	25	32	40	63	100	
	50kA	A	-	-	32	35	-	-	-	32	40	63	100	
	63kA	A	-	-	-	35	-	-	-	-	40	63	100	
Corrente nominale di breve durata ammissibile Icw	1sec	A	200	250	800	800	200	250	400	800	1000	1200	2100	
Correnti nominali di esercizio Ie AC1/AC21A (IEC/EN)	A	16	20	32	40	12	20	25	32	40	63	125		
	110V	A	10	10	25	25	10	10	16	25	25	32	40	
	AC15 (IEC/EN) 220÷230V	A	8	4	20	22	8	8	12	20	22	25	28	
	380÷400V	A	4	6	10	12	4	6	8	10	12	14	15	
	660÷690V	A	3	3,7	5,5	7,5	1,5	1,5	2	2	2	4	5	
Interruttori per motori in categorie di impiego in corrente alternata AC3 (IEC/EN)	3 fasi	220÷230V	kW	3,5	3,7	7,5	7,5	2,5	3	5,5	7,5	8	11	18,5
		380÷440V	kW	4,5	5,5	11	15	4	5,5	7,5	11	15	18,5	37
		500÷690V	kW	5,5	5,5	11	15	5,5	5,5	7,5	11	15	18,5	33
	1 fase (2 poli)	110V	kW	0,55	0,75	1,8	2,2	0,8	0,8	1,5	2,2	3	3,7	5
		220÷230V	kW	1,5	1,8	3,5	4,4	1,5	2,2	3	4	6,5	6,5	11
		380÷440V	kW	2,2	3	5,5	7	2,2	3	5,5	6,5	8	11,5	15
	AC23A (IEC/EN)	220÷230V	kW	3,7	4	8	9	3	5	6,5	8	8	12,5	30
		3 fasi 380÷440V	kW	6,5	7,5	15	18,5	6	7,5	11	15	18,5	30	45
		500÷690V	kW	7,5	7,5	15	15	7,5	7,5	11	18,5	22	30	37
1 fase (2 poli)	110V	kW	0,75	0,75	2,2	3	0,8	0,8	1,5	2,2	3	3,7	5	
	220÷230V	kW	1,8	2,2	3,5	5,2	1,7	2,5	3,7	5	6	7,5	11	
	380÷440V	kW	3	3,5	6	7,5	3	3,7	5,5	8	11	12,5	15	

① Validi per sistemi con neutro e terra, categoria di sovratensione III, grado di inquinamento 3.

Caratteristiche tecniche

Commutatori a camme serie GX e GN

Caratteristiche di impiego commutatori a camme

SERIE			GX				GN							
TIPO			GX16	GX20	GX32	GX40	GN12	GN20	GN25	GN32	GN40	GN63	GN125	
Interruttori per motori Comando diretto (UL/CSA-DOL) 3 fasi	115V	HP	1,5	1,5	3	5	1,5	1,5	3	5	5	7,5	15	
	230V	HP	3	3	7,5	10	3	3	5,5	10	10	15	25	
	480V	HP	5	5	15	15	-	-	10	15	20	25	50	
	600V	HP	5	5	15	15	-	-	10	15	20	25	40	
	1 fase (2 poli)	115V	HP	0,75	0,75	1,5	2	0,75	0,75	1,5	2	2	5	7,5
	230V	HP	1	1	3	5	1	2	3	5	5	10	15	
Interruttori per motori in categoria di impiego in corrente continua DC21A	48V	A	16	20	32	40	12	20	25	32	40	63	125	
	60V	A	16	20	32	40	12	20	25	32	40	50	80	
	le	110V	A	4	4	5	6	4	4	4	6	6	8	10
	220V	A	0,5	0,6	0,8	0,8	0,6	0,6	0,7	0,8	-	-	-	
	440V	A	0,25	0,25	0,25	0,25	0,25	0,25	-	-	-	-	-	
DC23A	24V	A	16(1)	20(1)	32(1)	40(1)	10(1)	20(1)	25(1)	32(1)	40(1)	50(1)	125(1)	
	48V	A	16(2)	20(2)	32(2)	40(1)	10(2)	20(2)	25(2)	32(2)	40(2)	50(2)	125(2)	
	le	60V	A	16(3)	20(3)	32(3)	40(3)	10(3)	20(3)	25(3)	32(3)	40(3)	50(3)	125(3)
Collegare in serie il n° dei contatti indicati tra parentesi	110V	A	10(3)	10(3)	15(3)	20(3)	5(3)	10(3)	12(3)	15(3)	20(3)	25(3)	50(3)	
	220V	A	7(4)	8(4)	12(4)	12(4)	5(4)	8(4)	10(4)	12(4)	12(4)	15(4)	20(4)	
DC13	24V	A	16	20	32	40	12	20	25	32	40	63	125	
	48V	A	14	16	25	32	10	16	20	25	32	40	100	
	60V	A	12	12	16	16	8	12	16	16	16	28	50	
	le	110V	A	0,8	1	3	3	1	1	1,5	3	3,3	4	
	220V	A	0,3	0,4	0,5	0,5	0,4	0,4	0,4	0,5	-	-	-	
	440V	A	0,15	0,15	0,15	0,15	0,15	0,15	-	-	-	-	-	
Durata meccanica	cicli		5x10 ⁶	5x10 ⁶	5x10 ⁶	5x10 ⁶	3x10 ⁶	5x10 ⁶	5x10 ⁶	5x10 ⁶	5x10 ⁶	5x10 ⁶	1x10 ⁶	
Vite del morsetto	M		3	3	4	4	3	3	3,5	4	4	5	2 x 5	
Coppia massima di serraggio	Nm		0,5	0,8	1,2	1,2	0,5	0,5	0,8	1,2	1,2	2	2	
Sezione conduttore	max. r/f	2xmm ²	2,5/2,5	2,5/2,5	10/6	10/6	1,5/1,5	2,5/2,5	4/4	6/4	10/6	16/10	70/50	
		2xAWG	14/14	14/14	8/10	8/10	16/16	14/14	10/12	10/12	8/10	6/8	2/0 / 1/0	
r. rigido f. flessibile	min. r/f	2xmm ²	0,5/0,5	0,5/0,5	1,5/1,5	1,5/1,5	0,5/0,5	0,5/0,5	0,5/0,5	1,5/1,5	1,5/1,5	2,5/2,5	2,5/2,5	
		2xAWG	20/20	20/20	16/16	16/16	20/20	20/20	20/20	16/16	16/16	14/14	14/14	
CONDIZIONI AMBIENTALI														
Temperatura di impiego	°C		-25...+55											
Temperatura di stoccaggio	°C		-40...+70											

Operational characteristics

SELECTION GUIDE

The choice of a rotary cam switch and the relative type are based on the functional diagram and the type of application as well.

IEC standards provide a comprehensible and quick classification of the most frequent utilisation categories:

AC1: Connection and disconnection of non-inductive or slightly inductive loads ($\cos\varphi \geq 0.95$)

AC21: Resistance furnaces

AC3: Starting and switching off motors during running

AC23A: Switching of motor loads or other highly inductive loads

AC15: Control of electromagnetic loads

For DC applications, the rotary cam switches are used for the switching of minor loads or in control circuits, such as:

DC13: Control of electromagnets

DC21A: Switching of resistive loads

DC23: Switching of highly inductive loads

Other prescriptions and recommendations concerning the use of cam switches as auxiliary equipment of electrical machines are given in IEC/EN 60204-1 standards and specifically as given under utilisation.

UTILISATION

MAIN SUPPLY DISCONNECTING SWITCH WITH EMERGENCY-STOP OPERATION:

- Red operating handle with yellow background
- Lockable in open position (OFF).

EMERGENCY-STOP SWITCH

- Red operating handle with yellow background
- Independent operation and the breaking of the load circuit of switching devices before the opening of its main contacts
- Rated capacity is to sufficient in order to break the sum of the rated operating currents of all the connected equipment
- Breaking capacity equal to the current of the largest motor when stalled (locked rotor) together with the total of the normal running currents of the other motors or loads.

MAIN SUPPLY DISCONNECTING SWITCH

- Used to disconnect all live electrical equipment from the power supply circuit
- Contact clearance distance is to comply with IEC/EN 60947-3 standards
- Provided with a means in order to be locked in the OFF position
- Selection of current breaking according to AC1 and AC21 utilisation categories.

SERIES		GX				GN									
TYPE		GX16	GX20	GX32	GX40	GN12	GN20	GN25	GN32	GN40	GN63	GN125			
Rated insulation voltage ^① Ui	IEC/EN	V	690	690	690	690	690	690	690	690	690	690			
	UL/CSA	V	600	600	600	600	300	300	600	600	600	600			
Rated impulse withstand voltage ^① Uimp	IEC/EN 60947-3	kV	6	6	6	6	6	6	6	6	6	8			
Conventional free air thermal current Ith	IEC/EN	A	16	20	32	40	12	20	25	32	40	63	125		
	UL/CSA (general purpose)	A	12	15	32	40	12	15	20	32	35	55	100		
Rated operating voltage ^①		V	440	440	440	440	480	480	480	480	480	690			
Operational impulse voltage		kV	4	4	4	4	4	4	4	4	4	6			
Maximum fuse size for short-circuit protection In (gG)	10kA	A	20	20	40	40	16	20	25	32	40	63	125		
	25kA	A	16	16	35	35	10	16	25	32	40	63	100		
	50kA	A	-	-	32	35	-	-	-	32	40	63	100		
	63kA	A	-	-	-	35	-	-	-	-	40	63	100		
Short-time withstand current Icw	1sec	A	200	250	800	800	200	250	400	800	1000	1200	2100		
Rated operational current Ie	AC1/AC21A (IEC/EN)	A	16	20	32	40	12	20	25	32	40	63	125		
	110V	A	10	10	25	25	10	10	16	25	25	32	40		
	AC15 (IEC/EN) 220-230V	A	8	4	20	22	8	8	12	20	22	25	28		
	380-400V	A	4	6	10	12	4	6	8	10	12	14	15		
	660-690V	A	3	3.7	5.5	7.5	1.5	1.5	2	2	2	4	5		
Motor power for switches in AC utilisation categories AC3 (IEC/EN)	3 phases	220-230V	kW	3.5	3.7	7.5	7.5	2.5	3	5.5	7.5	8	11	18.5	
		380-440V	kW	4.5	5.5	11	15	4	5.5	7.5	11	15	18.5	37	
		500-690V	kW	5.5	5.5	11	15	5.5	5.5	7.5	11	15	18.5	33	
	1 phase (2 poles)	110V	kW	0.55	0.75	1.8	2.2	0.8	0.8	1.5	2.2	3	3.7	5	
		220-230V	kW	1.5	1.8	3.5	4.4	1.5	2.2	3	4	6.5	6.5	11	
		380-440V	kW	2.2	3	5.5	7	2.2	3	5.5	6.5	8	11.5	15	
	AC23A (IEC/EN)	3 phases	220-230V	kW	3.7	4	8	9	3	5	6.5	8	8	12.5	30
			380-440V	kW	6.5	7.5	15	18.5	6	7.5	11	15	18.5	30	45
			500-690V	kW	7.5	7.5	15	15	7.5	7.5	11	18.5	22	30	37
1 phase (2 poles)	110V	kW	0.75	0.75	2.2	3	0.8	0.8	1.5	2.2	3	3.7	5		
	220-230V	kW	1.8	2.2	3.5	5.2	1.7	2.5	3.7	5	6	7.5	11		
	380-440V	kW	3	3.5	6	7.5	3	3.7	5.5	8	11	12.5	15		

① Valid for systems with earthed neutral, overvoltage category III, pollution degree 3.

Technical characteristics

Rotary cam switches, GX and GN series

Operational characteristics

SERIE			GX				GN						
TYPE			GX16	GX20	GX32	GX40	GN12	GN20	GN25	GN32	GN40	GN63	GN125
DOL motor powers for switches (UL/CSA-DOL) 3 phases	115V	HP	1.5	1.5	3	5	1.5	1.5	3	5	5	7.5	15
	230V	HP	3	3	7.5	10	3	3	5.5	10	10	15	25
	480V	HP	5	5	15	15	–	–	10	15	20	25	50
	600V	HP	5	5	15	15	–	–	10	15	20	25	40
	1 phase (2 poles)	120V	HP	0.75	0.75	1.5	2	0.75	0.75	1.5	2	2	5
	230V	HP	1	1.5	3	5	1	2	3	5	5	10	15
Motor power for switches in DC utilisation categories 1 contact													
DC21A	48V	A	16	20	32	40	12	20	25	32	40	63	125
	60V	A	16	20	32	40	12	20	25	32	40	50	80
le	110V	A	4	4	5	6	4	4	4	6	6	8	10
	220V	A	0.5	0.6	0.8	0.8	0.6	0.6	0.7	0.8	-	-	-
	440V	A	0.25	0.25	0.25	0.25	0.25	0.25	-	-	-	-	-
DC23A	24V	A	16(1)	20(1)	32(1)	40(1)	10(1)	20(1)	25(1)	32(1)	40(1)	50(1)	125(1)
	48V	A	16(2)	20(2)	32(2)	40(1)	10(2)	20(2)	25(2)	32(2)	40(2)	50(2)	125(2)
le	60V	A	16(3)	20(3)	32(3)	40(3)	10(3)	20(3)	25(3)	32(3)	40(3)	50(3)	125(3)
No. of contacts connected in series are indicated in brackets	110V	A	10(3)	10(3)	15(3)	20(3)	5(3)	10(3)	12(3)	15(3)	20(3)	25(3)	50(3)
	220V	A	7(4)	8(4)	12(4)	12(4)	5(4)	8(4)	10(4)	12(4)	12(4)	15(4)	20(4)
DC13	24V	A	16	20	32	40	12	20	25	32	40	63	125
	48V	A	14	16	25	32	10	16	20	25	32	40	100
	60V	A	12	12	16	16	8	12	16	16	16	28	50
le	110V	A	0.8	1	3	3	1	1	1.5	3	3	3.3	4
	220V	A	0.3	0.4	0.5	0.5	0.4	0.4	0.4	0.5	-	-	-
	440V	A	0.15	0.15	0.15	0.15	0.15	0.15	-	-	-	-	-
Mechanical life	cycles		5x10 ⁶	5x10 ⁶	5x10 ⁶	5x10 ⁶	3x10 ⁶	5x10 ⁶	5x10 ⁶	5x10 ⁶	5x10 ⁶	5x10 ⁶	1x10 ⁶
Terminal screw	M		3	3	4	4	3	3	3.5	4	4	5	2 x 5
Maximum tightening torque	Nm		0.5	0.8	1.2	1.2	0.5	0.5	0.8	1.2	1.2	2	2
Conductor cross section	max. r/f	2 mm ²	2.5/2.5	2.5/2.5	10/6	10/6	1.5/1.5	2.5/2.5	4/4	6/4	10/6	16/10	70/50
		2 AWG	14/14	14/14	8/10	8/10	16/16	14/14	10/12	10/12	8/10	6/8	2/0 / 1/0
r: rigidomin. r/f		2 mm ²	0.5/0.5	0.5/0.5	1.5/1.5	1.5/1.5	0.5/0.5	0.5/0.5	0.5/0.5	1.5/1.5	1.5/1.5	2.5/2.5	2.5/2.5
f: flexible		2 AWG	20/20	20/20	16/16	16/60	20/20	20/20	20/20	16/16	16/16	14/14	14/14
AMBIENT CONDITIONS													
Operating temperature	°C		-25...+55										
Storage temperature	°C		-40...+70										



LOVATO ELECTRIC S.P.A.
COMPONENTI ELETTRICI
PER AUTOMAZIONE INDUSTRIALE

VIA DON E. MAZZA, 12
24020 GORLE, BERGAMO, ITALY

TELEFONO +39 035 4282111
FAX +39 035 4282200
E-mail info@LovatoElectric.com

www.LovatoElectric.com