

LOVATO ELECTRIC S.P.A.

24020 GORLE (BERGAMO) ITALIA
VIA DON E. MAZZA, 12
TEL. 035 4282111
E-mail info@LovatoElectric.com
Web www.LovatoElectric.com



GB DUAL POWER SUPPLY MODULE

Operating manual

I MODULO PER DOPPIA ALIMENTAZIONE

Manuale operativo

ATL DPS1



WARNING!

- Carefully read the manual before the installation or use.
- This equipment is to be installed by qualified personnel, complying to current standards, to avoid damages or safety hazards.
- Before any maintenance operation on the device, remove all the voltages from measuring and supply inputs and short-circuit the CT input terminals.
- The manufacturer cannot be held responsible for electrical safety in case of improper use of the equipment.
- Products illustrated herein are subject to alteration and changes without prior notice. Technical data and descriptions in the documentation are accurate, to the best of our knowledge, but no liabilities for errors, omissions or contingencies arising there from are accepted.
- A circuit breaker must be included in the electrical installation of the building. It must be installed close by the equipment and within easy reach of the operator. It must be marked as the disconnecting device of the equipment: IEC/EN 61010-1 § 6.11.2.
- Clean the device with a soft dry cloth; do not use abrasives, liquid detergents or solvents.



ATTENTION !

- Lire attentivement le manuel avant toute utilisation et installation.
- Ces appareils doivent être installés par un personnel qualifié, conformément aux normes en vigueur en matière d'installations, afin d'éviter de causer des dommages à des personnes ou choses.
- Avant toute intervention sur l'instrument, mettre les entrées de mesure et d'alimentation hors tension et court-circuiter les transformateurs de courant.
- Le constructeur n'assume aucune responsabilité quant à la sécurité électrique en cas d'utilisation impropre du dispositif.
- Les produits décrits dans ce document sont susceptibles d'évoluer ou de subir des modifications à n'importe quel moment. Les descriptions et caractéristiques techniques du catalogue ne peuvent donc avoir aucune valeur contractuelle.
- Un interrupteur ou disjoncteur doit être inclus dans l'installation électrique du bâtiment. Celui-ci doit se trouver tout près de l'appareil et l'opérateur doit pouvoir y accéder facilement. Il doit être marqué comme le dispositif d'interruption de l'appareil : IEC/EN 61010-1 § 6.11.2.
- Nettoyer l'appareil avec un chiffon doux, ne pas utiliser de produits abrasifs, détergents liquides ou solvants.



ACHTUNG!

- Dieses Handbuch vor Gebrauch und Installation aufmerksam lesen.
- Zur Vermeidung von Personen- und Sachschäden dürfen diese Geräte nur von qualifiziertem Fachpersonal und unter Befolgung der einschlägigen Vorschriften installiert werden.
- Vor jedem Eingriff am Instrument die Spannungszufuhr zu den Messeingängen trennen und die Stromwandler kurzschließen.
- Bei zweckwidrigem Gebrauch der Vorrichtung übernimmt der Hersteller keine Haftung für die elektrische Sicherheit.
- Die in dieser Broschüre beschriebenen Produkte können jederzeit weiterentwickelt und geändert werden. Die im Katalog enthaltenen Beschreibungen und Daten sind daher unverbindlich und ohne Gewähr.
- In die elektrische Anlage des Gebäudes ist ein Ausschalter oder Trennschalter einzubauen. Dieser muss sich in unmittelbarer Nähe des Geräts befinden und vom Bediener leicht zugänglich sein. Er muss als Trennvorrichtung für das Gerät gekennzeichnet sein: IEC/EN 61010-1 § 6.11.2.
- Das Gerät mit einem weichen Tuch reinigen, keine Scheuermittel, Flüssigreinerer oder Lösungsmittel verwenden.



ADVERTENCIA

- Leer atentamente el manual antes de instalar y utilizar el regulador.
- Este dispositivo debe ser instalado por personal cualificado conforme a la normativa de instalación vigente a fin de evitar daños personales o materiales.
- Antes de realizar cualquier operación en el dispositivo, desconectar la corriente de las entradas de alimentación y medida, y cortocircuitar los transformadores de corriente.
- El fabricante no se responsabilizará de la seguridad eléctrica en caso de que el dispositivo no se utilice de forma adecuada.
- Los productos descritos en este documento se pueden actualizar o modificar en cualquier momento. Por consiguiente, las descripciones y los datos técnicos aquí contenidos no tienen valor contractual.
- La instalación eléctrica del edificio debe disponer de un interruptor o disyuntor. Este debe encontrarse cerca del dispositivo, en un lugar al que el usuario pueda acceder con facilidad. Además, debe llevar el mismo marcado que el interruptor del dispositivo (IEC/EN 61010-1 § 6.11.2).
- Limpiar el dispositivo con un trapo suave; no utilizar productos abrasivos, detergentes líquidos ni disolventes.



UPOZORNĚNÍ

- Návod se pozorně pročtěte, než začnete regulátor instalovat a používat.
- Tato zařízení smí instalovat kvalifikovaní pracovníci v souladu s platnými předpisy a normami pro předcházení úrazů osob či poškození věcí.
- Před jakýmkoli zásahem do přístroje odpojte měřicí a napájecí vstupy od napětí a zkratujte transformátory proudu.
- Výrobce nenese odpovědnost za elektrickou bezpečnost v případě nevhodného používání regulátoru.
- Výrobky popsané v tomto dokumentu mohou kdykoli projít úpravami či dalším vývojem. Popisy a údaje uvedené v katalogu nemají proto žádnou smluvní hodnotu.
- Spínač či disjunktory je nutno zabudovat do elektrického rozvodu v budově. Musí být nainstalovány v těsné blízkosti přístroje a snadno dostupné pracovníku obsluhy. Je nutno ho označit jako vypínací zařízení přístroje: IEC/EN 61010-1 § 6.11.2.
- Přístroj čistěte měkkou utěrkou, nepoužívejte abrazivní produkty, tekutá čistiště či rozpouštědla.



AVVERTIZARE!

- Cititi cu atenție manualul înainte de a instala sau utiliza.
- Acest echipament va fi instalat de personal calificat, în conformitate cu standardele actuale, pentru a evita deteriorări sau pericolele.
- Înainte de efectuarea oricărei operațiuni de întreținere asupra dispozitivului, îndepărtați toate tensiunile de la intrările de măsurare și de alimentare și scurtcircuitați bornele de intrare CT.
- Producătorul nu poate fi considerat responsabil pentru siguranța electrică în caz de utilizare incorectă a echipamentului.
- Produsele ilustrate în prezentul sunt supuse modificărilor și schimbărilor fără a notifica anterior. Datele tehnice și descrierile din documentație sunt precise, în măsura cunoștințelor noastre, dar nu se acceptă nicio răspundere pentru erorile, omisiunile sau evenimentele neprevăzute care apar ca urmare a acestora.
- Trebuie inclus un disjuncteur în instalația electrică a clădirii. Acesta trebuie instalat aproape de echipament și într-o zonă ușor accesibilă operatorului. Acesta trebuie marcat ca fiind dispozitivul de deconectare al echipamentului: IEC/EN 61010-1 § 6.11.2.
- Curățați instrumentul cu un material textil moale și uscat; nu utilizați substanțe abrazive, detergenți lichizi sau solvenți.



Manual revision history

REV	DATE	NOTES
00	21/05/2015	First release
01	22/12/2015	Technical data updating

ATTENZIONE!

- Leggere attentamente il manuale prima dell'utilizzo e l'installazione.
- Questi apparecchi devono essere installati da personale qualificato, nel rispetto delle vigenti normative impiantistiche, allo scopo di evitare danni a persone o cose.
- Prima di qualsiasi intervento sullo strumento, togliere tensione dagli ingressi di misura e di alimentazione e cortocircuare i trasformatori di corrente.
- Il costruttore non si assume responsabilità in merito alla sicurezza elettrica in caso di utilizzo improprio del dispositivo.
- I prodotti descritti in questo documento sono suscettibili in qualsiasi momento di evoluzioni o di modifiche. Le descrizioni ed i dati a catalogo non possono pertanto avere alcun valore contrattuale.
- Un interruttore o disgiuntore va compreso nell'impianto elettrico dell'edificio. Esso deve trovarsi in stretta vicinanza dell'apparecchio ed essere facilmente raggiungibile da parte dell'operatore. Deve essere marchiato come il dispositivo di interruzione dell'apparecchio: IEC/EN 61010-1 § 6.11.2.
- Pulire l'apparecchio con panno morbido, non usare prodotti abrasivi, detergenti liquidi o solventi.



UWAGA!

- Przed użyciem i instalacją urządzenia należy uważnie przeczytać niniejszą instrukcję.
- W celu uniknięcia obrażeń osób lub uszkodzenia mienia tego typu urządzenia muszą być instalowane przez wykwalifikowany personel, zgodnie z obowiązującymi przepisami.
- Przed rozpoczęciem jakichkolwiek prac na urządzeniu należy odłączyć napięcie od wejść pomiarowych i zasilania oraz zewrzeć zaciski przekładnika prądowego.
- Producent nie przyjmuje na siebie odpowiedzialności za bezpieczeństwo elektryczne w przypadku niewłaściwego użytkowania urządzenia.
- Produkty opisane w niniejszym dokumencie mogą być w każdej chwili udoskonalone lub zmodyfikowane. Opisy oraz dane katalogowe nie mogą mieć w związku z tym żadnej wartości umownej.
- W instalacji elektrycznej budynku należy uwzględnić przełącznik lub wyłącznik automatyczny. Powinien on znajdować się w bliskim sąsiedztwie urządzenia i być łatwo osiągalny przez operatora. Musi być oznaczony jako urządzenie służące do wyłączania urządzenia: IEC/EN 61010-1 § 6.11.2.
- Urządzenie należy czyścić miękką szmatką, nie stosować środków ściemych, płynnych detergentów lub rozpuszczalników.



注意！

- 装置設置等時、請仔細閱讀本手冊。
- 本設備只能由合格人員根據現行標準進行安裝。不正確安裝可能導致人員傷亡或財產損失。
- 對設備進行任何維護操作前，請確保切斷測量及電源輸入電壓，並短接 CT 輸入端子。
- 製造商不負責因設備使用不當導致的電氣安全問題。
- 產品說明如有變動和變化，恕不另行通知。我們竭力確保技術數據和描述是準確的，但對錯誤、遺漏或由此引起的意外事件概不負責。
- 電氣裝置中必須裝有斷路器。斷路器必須安裝在靠近設備且方便操作人員觸及的地方。還必須將斷路器標記為設備的斷開裝置：IEC/EN 61010-1 § 6.11.2。
- 請使用柔軟的干布清潔設備；切勿使用研磨劑、洗滌液或溶劑。



ПРЕДУПРЕЖДЕНИЕ!

- Прежде чем приступать к монтажу или эксплуатации устройства, внимательно ознакомьтесь с содержанием настоящего руководства.
- Во избежание травм или материального ущерба монтаж должен осуществляться только квалифицированным персоналом в соответствии с действующими нормативами.
- Перед проведением любых работ по техническому обслуживанию устройства необходимо обесточить все измерительные и питающие входные контакты, а также замкнуть накоротко входные контакты трансформатора тока (ТТ).
- Производитель не несет ответственность за обеспечение электробезопасности в случае ненадлежащего использования устройства.
- Издания, описанные в настоящем документе, в любой момент могут подвергнуться изменениям или усовершенствованиям. Поэтому каталожные данные и описания не могут рассматриваться как действительные с точки зрения контрактов.
- Электрическая сеть здания должна быть оснащена автоматическим выключателем, который должен быть расположен вблизи оборудования в пределах доступа оператора. Автоматический выключатель должен быть маркирован как отключающее устройство оборудования: IEC/EN 61010-1 § 6.11.2.
- Очистку устройства производить с помощью мягкой сухой ткани, без применения абразивных материалов, жидких моющих средств или растворителей.



DİKKAT!

- Montaj ve kullanımdan önce bu el kitabını dikkatlice okuyunuz.
- Bu aparatlar kişilere veya nesnelere zarar verme ihtimaline karşı yürürlükte olan sistem kurma normlarına göre kalifiye personel tarafından monte edilmelidir.
- Aparata (cihaz) herhangi bir müdahalede bulunmadan önce ölçim girişlerindeki gerilimi kesip akım transformatorlerine kısa devre yaptırınız.
- Üretici aparatın hatalı kullanımından kaynaklanan elektriksel güvenliği ait sorumluluk kabul etmez.
- Bu dokümanda tarif edilen ürünler her an evrimlere veya değişimlere açıktır. Bu sebeple katalogdaki tarif ve değerler herhangi bir bağlayıcı değeri haiz değildir.
- Binanın elektrik sisteminde bir anahtar veya şalter bulunmalıdır. Bu anahtar veya şalter operatörün kolaylıkla ulaşabileceği yakın bir yerde olmalıdır. Aparatı (cihaz) devreden çıkartma görevi yapan bu anahtar veya şalterin markası: IEC/EN 61010-1 § 6.11.2.
- Aparatı (cihaz) sıvı deterjan veya solvent kullanılarak yumuşak bir bez ile siliniz aşındırıcı temizlik ürünleri kullanmayınız.



The complete operating manual is downloadable from website www.lovatoelectric.com

Il manuale operativo completo è scaricabile dal sito www.lovatoelectric.com

Cronologia revisioni manuale

REV	DATA	NOTE
00	21/05/2015	Prima versione
01	22/12/2015	Aggiornamento dati tecnici

INTRODUCTION

The dual power supply module ATL DPS1 automatically selects the most appropriate source between two single-phase AC power supply lines. The selection criterion is based on the presence of voltage within the minimum and maximum preset limits. Its typical application is to provide auxiliary power to the switches and the control devices inside an emergency switching panel. It can therefore be used in conjunction with automatic transfer switch controllers from ATL series. Switching between the two lines occurs with defined and repeatable thresholds and times, thus increasing reliability. The two lines are separated with electrical safety interlocks. A self-diagnosis is also performed under the supervision of a microcontroller. If both supply lines are absent and/or in the event of operation fault self-diagnosis, an additional alarm relay reports the alarm status to external devices.

DESCRIPTION

- Automatic switch of auxiliary supply line.
- 3U (54 mm) modular construction for DIN rail.
- Two input single-phase supply lines.
- The device is powered by the line available.
- Priority line 1.
- One auxiliary power output.
- 4 status display LEDs:
 - Line 1 OK (green)
 - Line 2 OK (green)
 - Power output OK (green)
 - Alarm (red).
- Rated voltage set to 110 VAC or 230 VAC via a jumper.
- Alarm contact.
- Self-diagnosis in case of internal fault (terminals 11-14, opened on alarm, closed under normal conditions).

FRONT INDICATIONS

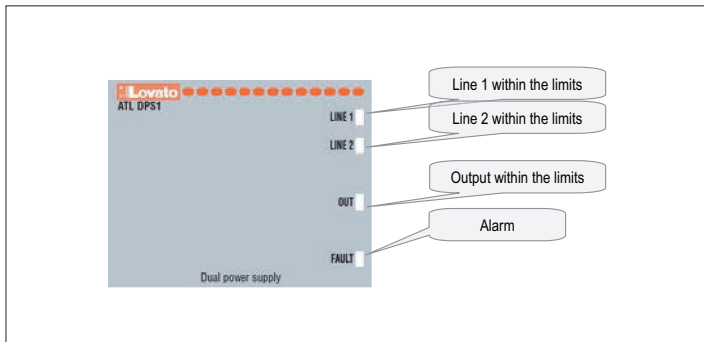

OPERATION

ATL DPS1 monitors the two input lines and the reference voltage is selected through the terminals Y1 Y2 of the device. If there is no connection between Y1 Y2, the control thresholds referring to 230 VAC are selected; if there is a jumper between the two terminals, the reference voltage selected is 110 VAC. The following table shows the control thresholds applied to the two power supply voltages:

	110VAC		230VAC	
	MIN	MAX	MIN	MAX
Line absent	< 88V	> 152V	< 176V	> 288V
Line present	> 92V	< 144V	> 185V	< 273V

Using the thresholds above ATL DPS1 outputs one of the power supplies available according to the logic shown in the table:

LINE 1 STATUS STATO LINEA 1	LED LINE 1 LED LINE 1	LINE 2 STATUS STATO LINEA 2	LED LINE 2 LED LINE 2	OUTPUT USCITA	LED OUT LED OUT	ATL DPS1	ALARM CONTACT CONTATTO DI ALLARME	LED FAULT LED FAULT
OK OK	ON ON	<MIN OR >MAX <MIN O >MAX	OFF OFF	ON - FROM LINE 1 ON - DA LINEA 1	ON ON	ON - OK ON - OK	CLOSED CHIUSO	OFF OFF
OK OK	ON ON	OK OK	ON ON	ON - FROM LINE 1 ON - DA LINEA 1	ON ON	ON - OK ON - OK	CLOSED CHIUSO	OFF OFF
<MIN OR >MAX <MIN O >MAX	OFF OFF	OK OK	ON ON	ON - FROM LINE 2 ON - DA LINEA 2	ON ON	ON - OK ON - OK	CLOSED CHIUSO	OFF OFF
<MIN <MIN	OFF OFF	<MIN <MIN	OFF OFF	OFF OFF	OFF OFF	OFF OFF	OPEN APERTO	OFF OFF
>MAX >MAX	OFF OFF	<MIN OR >MAX <MIN O >MAX	OFF OFF	OFF OFF	OFF OFF	ON ON	OPEN APERTO	ON ON
<MIN OR >MAX <MIN O >MAX	OFF OFF	>MAX >MAX	OFF OFF	OFF OFF	OFF OFF	ON ON	OPEN APERTO	ON ON
OK	ON	OK	ON	OFF	OFF	ON - INTERNAL FAULT RELAY	OPEN	ON
	ON	NOT OK	OFF	OFF	OFF	ON - ANOMALIA RELE' INTERNI	APERTO	ON
OK	ON	OK	ON	OFF	OFF	ON - INTERNAL FAULT RELAY	OPEN	ON
NOT OK	OFF	>MIN	ON	OFF	OFF	ON - ANOMALIA RELE' INTERNI	APERTO	ON

INTRODUZIONE

Il modulo per doppia alimentazione ATL DPS1 consente di selezionare automaticamente la sorgente più indicata fra due linee di alimentazione monofase in tensione alternata. Il criterio di selezione si basa sulla presenza della tensione entro dei limiti minimi e massimi prestabiliti. La sua applicazione tipica consiste nel fornire alimentazione ausiliaria agli interruttori ed ai dispositivi di controllo all'interno di un quadro di commutazione di emergenza. Può essere quindi utilizzato in abbinamento ai commutatori di rete automatici della serie ATL. La commutazione fra le due linee viene effettuata con soglie e tempi definiti e ripetibili, garantendo maggiore sicurezza. Le due linee sono separate con interblocchi elettrici di sicurezza. Viene anche eseguita una autodiagnosi sotto la supervisione di un microcontrollore. In caso di mancanza di entrambe le linee di alimentazione e/o di autodiagnosi di anomalia di funzionamento, un relé di allarme aggiuntivo segnala lo stato di allarme a dispositivi esterni.

DESCRIZIONE

- Modulo di commutazione automatica di linea ausiliaria di alimentazione.
- Esecuzione modulare 3U (54mm) per guida DIN.
- Due linee di alimentazione monofase in ingresso.
- Il dispositivo è autoalimentato dalla linea disponibile.
- Linea 1 prioritaria.
- Una uscita di alimentazione ausiliaria.
- 4 LED di visualizzazione stato:
 - Linea 1 OK (verde)
 - Linea 2 OK (verde)
 - Uscita alimentazione OK (verde)
 - Allarme (rosso).
- Impostazione tensione nominale 110VAC o 230 VAC tramite ponticello.
- Autodiagnosi in caso di guasto interno (contatti relé incollati / non funzionanti).
- Relé di allarme con contatto in uscita (morsetti 11-14, aperto in caso di allarme, chiuso in condizioni normali).

INDICAZIONI FRONTALI

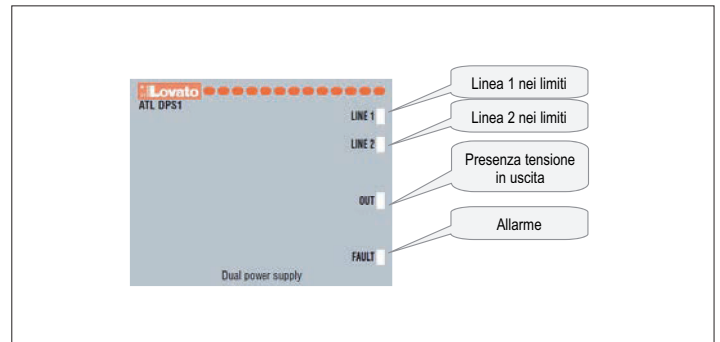

FUNZIONAMENTO

L'ATL DPS1 esegue un monitoraggio delle due linee d'ingresso e la selezione della tensione di riferimento è effettuata attraverso i terminali Y1 Y2 del dispositivo. In assenza della connessione tra Y1 Y2 sono selezionate le soglie di controllo riferite ai 230VAC, in presenza del ponticello tra i due terminali la tensione di riferimento selezionata è 110 VAC. Nella tabella seguente sono riportate le soglie di controllo applicate per le due tensioni di alimentazione:

	110VAC		230VAC	
	MIN	MAX	MIN	MAX
Mancanza linea	< 88V	> 152V	< 176V	> 288V
Presenza linea	> 92V	< 144V	> 185V	< 273V

Utilizzando le soglie sopra indicate l'ATL DPS1 conterrà in uscita una delle alimentazioni disponibili seguendo la logica riportata in tabella:

SWITCHING TIMES

Maximum switching time upon connection of Line 1 with Line 2 absent 1.15 sec

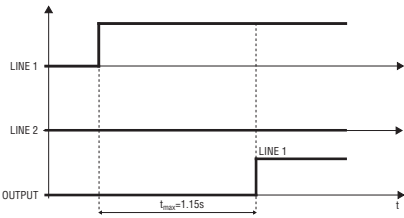

Maximum switching time upon connection of Line 2 with Line 1 absent 1.15 sec

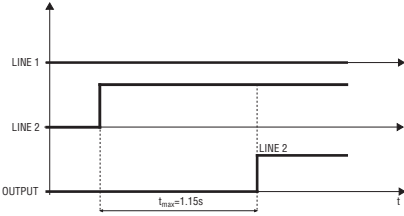

Maximum switching time upon connection of Line 1 with Line 2 present.

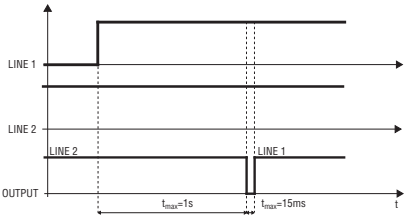

Maximum switching time upon disconnection of Line 1 with Line 2 present.

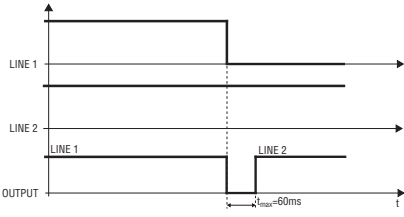

Maximum switching time upon simultaneous connection of Line 1 and Line 2.

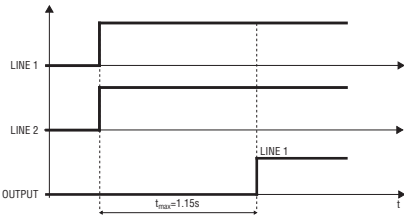

TEMPI DI COMMUTAZIONE

Tempo di commutazione massimo all'inserzione della Linea 1 con Linea 2 assente 1.15 sec

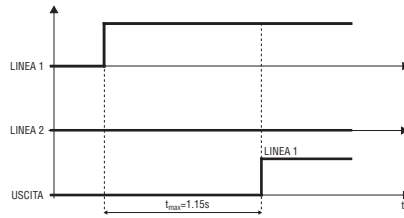

Tempo di commutazione massimo all'inserzione della Linea 2 con Linea 1 assente 1.15 sec

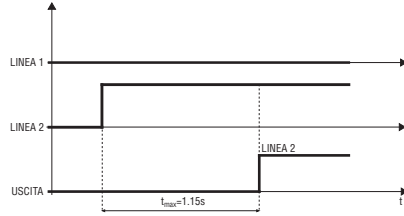

Tempo di commutazione massimo all'inserzione della Linea 1 con Linea 2 presente.

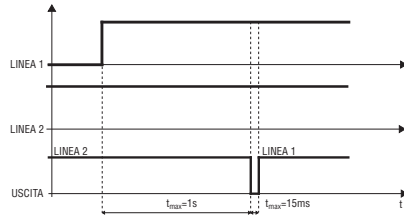

Tempo di commutazione massimo alla disinserzione della Linea 1 con Linea 2 presente.

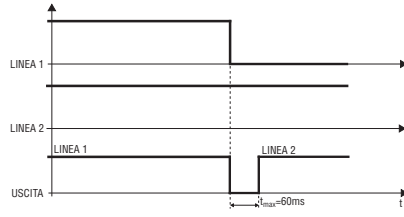

Tempo di commutazione massimo all'inserzione contemporanea della Linea 1 e della Linea 2.

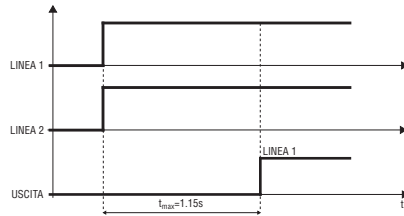

TERMINAL LAYOUT

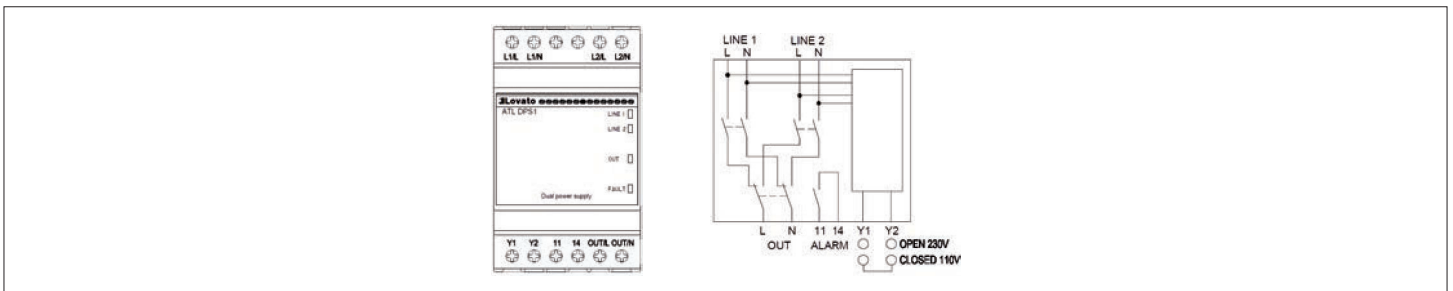

DISPOSIZIONE MORSETTI

MECHANICAL DIMENSIONS [mm]

DIMENSIONI MECCANICHE [mm]

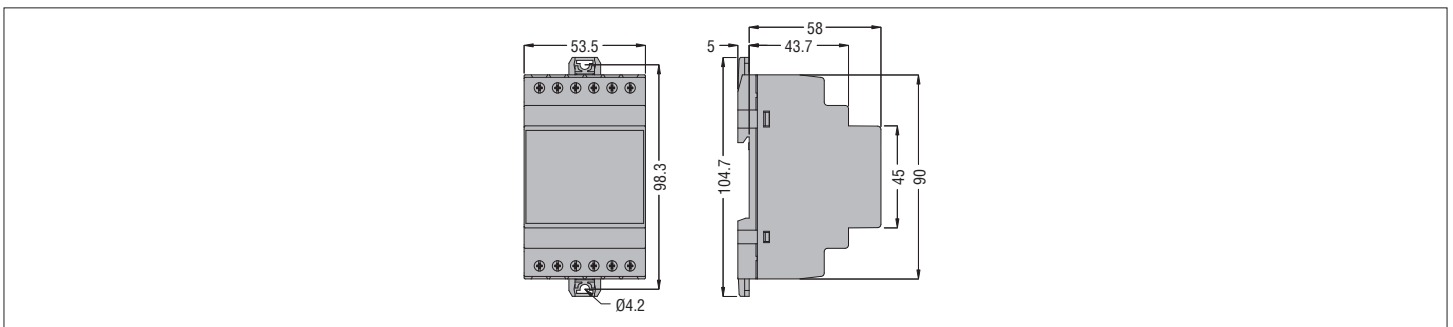



TECHNICAL CHARACTERISTICS

Supply (Voltmetric inputs Line 1 – Line 2)

Rated voltage U_s	110...230V~
Operating range	80...300V~
Frequency	45...66Hz
Power consumption/dissipation	7VA – 2,4W
Time of immunity to micro-interruption	Vero valore efficace (True RMS)
Impedance measurement inputs	L - N > 8M Ω
Connection method	Power supplied by the system with phase-to-neutral $\leq 300V$ -
Recommended fuses	4A FAST

Accuracy intervention

Conditions of temperature measurement	+23°C $\pm 2^\circ\text{C}$
Voltage	$\pm 1\%$ (80...300V~)

Relay outputs L1 – L2 \rightarrow OUT

Contact type	2 x 2 NO (presence Line 1 and Line 2) 1 x 2 CO (relay exchange line)
Rated voltage	250V~
Maximum voltage switching	300V~
Rated current	4A 250V~ AC1 - 1,5A 250V~ AC15
UL rating	4A 250V~ B300
Electrical endurance	1 x 10 ⁵
Mechanical endurance	1 x 10 ⁷

Alarm relay output

Contact type	1 NO
Rated voltage	250V~
Maximum voltage switching	250V~
Rated current	3A 250V~ AC1 - 3A 30V= AC1
UL rating	3A 30V= L/R 0ms - 3A 250V~ $\cos\phi$ 1
Electrical endurance	1 x 10 ⁵
Mechanical endurance	2 x 10 ⁷

Insulation voltage

Rated insulation voltage U_i	300V~
Rated impulse withstand voltage U_{imp}	4kV
Power frequency withstand voltage	2,21kV

Ambient conditions

Operating temperature	-30 - +70°C
Storage temperature	-30 - +80°C
Relative humidity	<80% (IEC/EN 60068-2-78)
Pollution degree	2
Overvoltage category	3
Measurement category	III
Climatic sequence	Z/ABDM (IEC/EN 60068-2-61)
Shock resistance	15g (IEC/EN 60068-2-27)
Vibration resistance	0.7g (IEC/EN 60068-2-6)



Connections

Terminal type	Screw-type (fixed)
No. of terminals	2 for voltage inputs L1 2 for voltage inputs L2 2 for voltage output 2 for alarm contact relay 2 for rated voltage set-up
Cable cross section (min & max)	0.2 - 4.0 mm ² (24 - 12 AWG)
Term. tightening torque	0,8Nm (7lbin)

Housing

Version	Modular housing 3 modules (DIN 43880)
Material	Polyamide RAL 7035
Degree of protection	IP40 at the front - IP20 for connections
Weight	300 g

Certifications and compliance

Certifications obtained	cULus, EAC
Reference standards	IEC/EN 61010-1, IEC/EN 61010-2-030, IEC/EN 61000-6-2, IEC/EN 61000-6-4, IEC/EN 60947-1  , IEC/EN 60947-6-1  , UL508, CSA C22.2-N°14

UL Marking	For Use on a Flat surface of a Type 1, 4X enclosure. Use 75°C copper (CU) conductor only AWG Range: 18 - 12AWG Field wiring terminals tighteningtorque: 7 - 9LBin
------------	--

 Notice: this product has been designed for environment A. Use of this product in environment B may cause unwanted electromagnetic disturbances in which case the user may be required to take adequate mitigation measures.



CARATTERISTICHE TECNICHE

Alimentazione (ingressi voltmetrici Linea 1 – Linea 2)

Tensione nominale U_e	110...230V~
Campo di misura	80...300V~
Campo di frequenza	45...66Hz
Potenza massima assorbita/dissipata	7VA – 2,4W
Tipo di misura	Vero valore efficace (True RMS)
Impedenza ingressi di misura	L - N > 8M Ω
Modalità di collegamento	Alimentazione prelevata da sistema con tensione fase-neutro $\leq 300V$ ~
Fusibili raccomandati	4A rapidi

Precisione intervento

Condizioni di misura Temperatura	+23°C $\pm 2^\circ\text{C}$
Tensione	$\pm 1\%$ (80...300V~)

Uscite relé L1 – L2 \rightarrow OUT

Composizione contatti	2 x 2 NO (presenza linea 1 e linea 2) 1 x 2 CO (relé scambio linea)
Tensione d'impiego	250V~
Tensione massima di commutazione	300V~
Portata nominale	4A 250V~ AC1 - 1,5A 250V~ AC15
Dati d'impiego UL	4A 250V~ B300
Durata elettrica	1 x 10 ⁵
Durata meccanica	1 x 10 ⁷

Uscite relé allarme

Composizione contatti	1 NO
Tensione d'impiego	250V~
Tensione massima di commutazione	250V~
Portata nominale termica	3A 250V~ 3A 30V=
Dati d'impiego UL	3A 30V= L/R 0ms - 3A 250V~ $\cos\phi$ 1
Durata elettrica	1 x 10 ⁵
Durata meccanica	2 x 10 ⁷

Tensione di isolamento

Tensione nominale d'isolamento U_i	300V~
Tensione nominale di tenuta a impulso U_{imp}	4kV
Tensione di tenuta a frequenza d'esercizio	2,21kV

Condizioni ambientali di funzionamento

Temperatura d'impiego	-30 - +70°C
Temperatura di stoccaggio	-30 - +80°C
Umidità relativa	<80% (IEC/EN 60068-2-78)
Grado inquinamento ambientale	2
Categoria di installazione	3
Categoria di misura	III
Sequenza climatica	Z/ABDM (IEC/EN 60068-2-61)
Resistenza agli urti	15g (IEC/EN 60068-2-27)
Resistenza alle vibrazioni	0.7g (IEC/EN 60068-2-6)



Connessioni

Tipo di morsetti	A vite (fissi)
N° morsetti	2 per ingressi tensione L1 2 per ingressi tensione L2 2 per uscita tensione 2 per contatto relé allarme 2 per predisposizione tensione nominale
Sezione conduttori (min e max)	0.2 - 4.0 mm ² (24 - 12 AWG)
Coppia di serraggio mors.	0,8Nm (7lbin)

Contenitore

Esecuzione	Contenitore modulare 3 moduli (DIN 43880)
Materiale	Poliamide RAL 7035
Grado di protezione	IP40 sul fronte - IP20 connessioni
Peso	300g

Omologazioni e conformità

Certificazioni ottenute	cULus, EAC
Conformi alle norme	IEC/EN 61010-1, IEC/EN 61010-2-030, IEC/EN 61000-6-2, IEC/EN 61000-6-4, IEC/EN 60947-1  , IEC/EN 60947-6-1  , UL508, CSA C22.2-N°14

UL Marking	For Use on a Flat surface of a Type 1, 4X enclosure. Use 75°C copper (CU) conductor only AWG Range: 18 - 12AWG Field wiring terminals tighteningtorque: 7 - 9LBin
------------	--

 Avvertenza: questo prodotto è stato progettato per l'ambiente A. L'uso di questo prodotto nell'ambiente B può provocare disturbi elettromagnetici indesiderati, nel qual caso l'utilizzatore può dover prendere adeguate misure per loro attenuazione.