

LOVATO ELECTRIC S.P.A.

24020 GORLE (BERGAMO) ITALIA  
VIA DON E. MAZZA, 12  
TEL. 035 4282111  
E-mail info@LovatoElectric.com  
Web www.LovatoElectric.com



## GB INTERFACE PROTECTION SYSTEM

Compliant with  
VDE-AR-N 4105 and VDE V 0126-1-1  
application guides

Instruction manual

# PMVF 80



### WARNING!

- Carefully read the manual before the installation or use.
- This equipment is to be installed by qualified personnel, complying to current standards, to avoid damages or safety hazards.
- Before any maintenance operation on the device, remove all the voltages from measuring and supply inputs and short-circuit the CT input terminals.
- The manufacturer cannot be held responsible for electrical safety in case of improper use of the equipment.
- Products illustrated herein are subject to alteration and changes without prior notice. Technical data and descriptions in the documentation are accurate, to the best of our knowledge, but no liabilities for errors, omissions or contingencies arising there from are accepted.
- A circuit breaker must be included in the electrical installation of the building. It must be installed close by the equipment and within easy reach of the operator. It must be marked as the disconnecting device of the equipment: IEC / EN 61010-1 § 6.11.2.
- Clean the device with a soft dry cloth; do not use abrasives, liquid detergents or solvents.



### ATTENTION !

- Lire attentivement le manuel avant toute utilisation et installation.
- Ces appareils doivent être installés par un personnel qualifié, conformément aux normes en vigueur en matière d'installations, afin d'éviter de causer des dommages à des personnes ou choses.
- Avant toute intervention sur l'instrument, mettre les entrées de mesure et d'alimentation hors tension et court-circuiter les transformateurs de courant.
- Le constructeur n'assume aucune responsabilité quant à la sécurité électrique en cas d'utilisation impropre du dispositif.
- Les produits décrits dans ce document sont susceptibles d'évoluer ou de subir des modifications à n'importe quel moment. Les descriptions et caractéristiques techniques du catalogue ne peuvent donc avoir aucune valeur contractuelle.
- Un interrupteur ou disjoncteur doit être inclus dans l'installation électrique du bâtiment. Celui-ci doit se trouver tout près de l'appareil et l'opérateur doit pouvoir y accéder facilement. Il doit être marqué comme le dispositif d'interruption de l'appareil : IEC / EN 61010-1 § 6.11.2.
- Nettoyer l'appareil avec un chiffon doux, ne pas utiliser de produits abrasifs, détergents liquides ou solvants.



### ACHTUNG!

- Dieses Handbuch vor Gebrauch und Installation aufmerksam lesen.
- Zur Vermeidung von Personen- und Sachschäden dürfen diese Geräte nur von qualifiziertem Fachpersonal und unter Befolgung der einschlägigen Vorschriften installiert werden.
- Vor jedem Eingriff am Instrument die Spannungszufuhr zu den Messeingängen trennen und die Stromwandler kurzschließen.
- Bei zweckwidrigem Gebrauch der Vorrichtung übernimmt der Hersteller keine Haftung für die elektrische Sicherheit.
- In dieser Broschüre beschriebene Produkte können jederzeit weiterentwickelt und geändert werden. Die im Katalog enthaltenen Beschreibungen und Daten sind daher unverbindlich und ohne Gewähr.
- In die elektrische Anlage des Gebäudes ist ein Ausschalter oder Trennschalter einzubauen. Dieser muss sich in unmittelbarer Nähe des Geräts befinden und vom Bediener leicht zugänglich sein. Er muss als Trennvorrichtung für das Gerät gekennzeichnet sein: IEC / EN 61010-1 § 6.11.2.
- Das Gerät mit einem weichen Tuch reinigen, keine Scheuermittel, Flüssigreinerer oder Lösungsmittel verwenden.



### ADVERTENCIA

- Leer atentamente el manual antes de instalar y utilizar el regulador.
- Este dispositivo debe ser instalado por personal cualificado conforme a la normativa de instalación vigente a fin de evitar daños personales o materiales.
- Antes de realizar cualquier operación en el dispositivo, desconectar la corriente de las entradas de alimentación y medida, y cortocircuitar los transformadores de corriente.
- El fabricante no se responsabilizará de la seguridad eléctrica en caso de que el dispositivo no se utilice de forma adecuada.
- Los productos descritos en este documento se pueden actualizar o modificar en cualquier momento. Por consiguiente, las descripciones y los datos técnicos aquí contenidos no tienen valor contractual.
- La instalación eléctrica del edificio debe disponer de un interruptor o disyuntor. Este debe encontrarse cerca del dispositivo, en un lugar al que el usuario pueda acceder con facilidad. Además, debe llevar el mismo marcado que el interruptor del dispositivo (IEC / EN 61010-1 § 6.11.2).
- Limpiar el dispositivo con un trapo suave; no utilizar productos abrasivos, detergentes líquidos ni disolventes.



### UPOZORNĚNÍ

- Návod se pozorně pročtěte, než začnete regulátor instalovat a používat.
- Tato zařízení smí instalovat kvalifikovaní pracovníci v souladu s platnými předpisy a normami pro předcházení úrazu osob či poškození věcí.
- Před jakýmkoli zásahem do přístroje odpojte měřicí a napájecí vstupy od napětí a zkratujte transformátory proudu.
- Výrobce nenese odpovědnost za elektrickou bezpečnost v případě nevhodného používání regulátoru.
- Výrobky popsané v tomto dokumentu mohou kdykoli projít úpravami či dalším vývojem. Popisy a údaje uvedené v katalogu nemají proto žádnou smluvní hodnotu.
- Spínač či odpojovač je nutno zabudovat do elektrického rozvodu v budově. Musí být nainstalován v těsné blízkosti přístroje a snadno dostupné pracovníku obsluhy. Je nutno ho označit jako vypínači zařízení přístroje: IEC / EN 61010-1 § 6.11.2.
- Přístroj čistěte měkkou utěrkou, nepoužívejte abrazivní produkty, tekutá čistidla či rozpouštědla.



### AVVERTIZARE!

- Cititi cu atenție manualul înainte de instalare sau utilizare.
- Acest echipament va fi instalat de personal calificat, în conformitate cu standardele actuale, pentru a evita deteriorări sau pericolele.
- Înainte de efectuarea oricărei operațiuni de întreținere asupra dispozitivului, îndeplățiți toate tensiunile de la intrările de măsurare și de alimentare și scurtcircuitați bornele de intrare CT.
- Producătorul nu poate fi considerat responsabil pentru siguranța electrică în caz de utilizare incorectă a echipamentului.
- Produsele ilustrate în prezentul sunt supuse modificărilor și schimbărilor fără notificare anterioară. Datele tehnice și descrierile din documentație sunt precise, în măsura cunoștințelor noastre, dar nu se acceptă nicio răspundere pentru erorile, omisiunile sau evenimentele neprevăzute care apar ca urmare a acestora.
- Trebuie inclus un disjuncteur în instalația electrică a clădirii. Acesta trebuie instalat aproape de echipament și într-o zonă ușor accesibilă operatorului. Acesta trebuie marcat ca fiind dispozitivul de deconectare al echipamentului: IEC/EN 61010-1 § 6.11.2.
- Curățați instrumentul cu un material textil moale și uscat; nu utilizați substanțe abrazive, detergenți lichizi sau solvenți.



### ATTENZIONE!

- Leggere attentamente il manuale prima dell'utilizzo e l'installazione.
- Questi apparecchi devono essere installati da personale qualificato, nel rispetto delle vigenti normative impiantistiche, allo scopo di evitare danni a persone o cose.
- Prima di qualsiasi intervento sullo strumento, togliere tensione dagli ingressi di misura e di alimentazione e cortocircuare i trasformatori di corrente.
- Il costruttore non si assume responsabilità in merito alla sicurezza elettrica in caso di utilizzo improprio del dispositivo.
- I prodotti descritti in questo documento sono suscettibili in qualsiasi momento di evoluzioni o di modifiche. Le descrizioni ed i dati a catalogo non possono pertanto avere alcun valore contrattuale.
- Un interruttore o disgiuntore va compreso nell'impianto elettrico dell'edificio. Esso deve trovarsi in stretta vicinanza dell'apparecchio ed essere facilmente raggiungibile da parte dell'operatore. Deve essere marchiato come il dispositivo di interruzione dell'apparecchio: IEC / EN 61010-1 § 6.11.2.
- Pulire l'apparecchio con panno morbido, non usare prodotti abrasivi, detergenti liquidi o solventi.



### UWAGA!

- Przed użyciem i instalacją urządzenia należy uważnie przeczytać niniejszą instrukcję.
- W celu uniknięcia obrażeń osób lub uszkodzenia mienia tego typu urządzenia muszą być instalowane przez wykwalifikowany personel, zgodnie z obowiązującymi przepisami.
- Przed rozpoczęciem jakichkolwiek prac na urządzeniu należy odłączyć napięcie od wejść pomiarowych i zasilania oraz zewrzeć zaciski przekładnika prądowego.
- Producent nie przyjmuje na siebie odpowiedzialności za bezpieczeństwo elektryczne w przypadku niewłaściwego użytkowania urządzenia.
- Produkty opisane w niniejszym dokumencie mogą być w każdej chwili udoskonalone lub zmodyfikowane. Opisy oraz dane katalogowe nie mogą mieć w związku z tym żadnej wartości umownej.
- W instalacji elektrycznej budynku należy uwzględnić przełącznik lub wyłącznik automatyczny. Powinien on znajdować się w bliskim sąsiedztwie urządzenia i być łatwo osiągalny przez operatora. Musi być oznaczony jako urządzenie służące do wyłączania urządzenia: IEC / EN 61010-1 § 6.11.2.
- Urządzenie należy czyścić miękką szmatką, nie stosować środków ściernych, płynnych detergentów lub rozpuszczalników.



### 注意

- 仔细阅读手册。
- 设备只能由合格人员根据现行标准进行安装。否则可能导致损坏或安全危害。
- 对设备进行任何维护操作前，请务必切断测量和电源输入端子-弱电压。并短路CT输入端子。
- 制造商不负责因设备使用不当导致的电气安全问题。
- 产品说明如有变动和变化，恕不另行通知。我们竭力确保技术数据和描述是准确的，但对错误、遗漏或由此引起的意外事件概不负责。
- 带电设备电气装置中必须装有断路器。断路器必须安装在靠近设备且方便操作人员触及的地方。还必须将断路器标记为设备的断开装置：IEC / EN 61010-1 § 6.11.2。
- 请使用柔软的干布清洁设备；切勿使用研磨剂、洗涤剂或溶剂。



### ПРЕДУПРЕЖДЕНИЕ!

- Прежде чем приступать к монтажу или эксплуатации устройства, внимательно ознакомьтесь с содержанием настоящего руководства.
- Во избежание травм или материального ущерба монтаж должен осуществляться только квалифицированным персоналом в соответствии с действующими нормативами.
- Перед проведением любых работ по техническому обслуживанию устройства необходимо обесточить все измерительные и питающие входные контакты, а также замкнуть накоротко входные контакты трансформатора тока (ТТ).
- Производитель не несет ответственность за обеспечение электробезопасности в случае ненадлежащего использования устройства.
- Изделия, описанные в настоящем документе, в любой момент могут подвергнуться изменениям или усовершенствованиям. Поэтому каталожные данные и описания не могут рассматриваться как действительные с точки зрения контрактов.
- Электрическая сеть здания должна быть оснащена автоматическим выключателем, который должен быть расположен вблизи оборудования в пределах доступа оператора. Автоматический выключатель должен быть промаркирован как отключающее устройство оборудования: IEC / EN 61010-1 § 6.11.2.
- Очистку устройства производить с помощью мягкой сухой ткани, без применения абразивных материалов, жидких мощных средств или растворителей.



### DIKKAT!

- Montaj ve kullanımdan önce bu el kitabını dikkatlice okuyunuz.
- Bu aparatlar kişilere veya nesnelere zarar verme ihtimaline karşı yürürlükte olan sistem kurma normlarına göre kalifiye personel tarafından monte edilmelidir.
- Aparatı (cihaz) herhangi bir müdahalede bulunmadan önce ölçüm girişlerindeki genilimi kesip akım transformatorlerinede kısa devre yaptırınız.
- Üretici aparatın hatalı kullanımından kaynaklanan elektriksel güvenliği ait sorumluluk kabul etmez.
- Bu dokümanda tarif edilen ürünler her an evrimlere veya değişimlere açıktır. Bu sebeple katalogdaki tarif ve değerler herhangi bir bağlayıcı değeri haiz değildir.
- Binanın elektrik sisteminde bir anahtar veya şalter bulunmalıdır. Bu anahtar veya şalter operatörün kolaylıkla ulaşabileceği yakın bir yerde olmalıdır. Aparatı (cihaz) devreden çıkartma görevi yapan bu anahtar veya şalterin markası: IEC / EN 61010-1 § 6.11.2.
- Aparatı (cihaz) sıvı deterjan veya solvent kullanılarak yumuşak bir bez ile siliniz aşındırıcı temizlik ürünleri kullanmayınız.



Bedienungsanleitung in deutscher Sprache:  
Instruction manual in german language:  
[www.lovatoelectric.com/PMVF80/PMVF80/snp](http://www.lovatoelectric.com/PMVF80/PMVF80/snp)

INDEX	Pag.	Pag.	
Introduction .....	2	Alarm indications and event list .....	9
Description .....	2	Self-diagnosis .....	9
Trip thresholds .....	2	Current, power and energy measurements .....	9
Front button functions .....	3	Power Unbalance Limit (LSP) control .....	10
Displaying measurements .....	3	Communication .....	10
Table of display pages .....	4	Wiring diagrams .....	10
Main menu .....	5	Backup activation modes .....	11
Password-protected access .....	5	Terminal layout .....	11
Setting parameters (setup) .....	5	Mechanical dimensions .....	11
Parameter table .....	6	Mounting and demounting instructions, symbols .....	11
Commands Menu .....	8	Technical characteristics .....	12

## INTRODUCTION

The PMVF 80 equipment has been designed as an Interface Protection (IP) in accordance with VDE-AR-N 4105 and VDE V 0126-1-1 application guide. It can be applied to all LV generation systems (photovoltaic, wind) where it is used to control the interface switch between generation system and public grid.

In the event of problems on the grid (e.g. due to maintenance), the system trips by opening the Interface switch (e.g. contactor) and isolating the generation system. In the event of Interface Switch (IS) failure, it can also control a backup device to disconnect the generation system in any case.

The equipment features 4 digital inputs permitting the connection of the system to the signals provided by the network operator to meet the requirements of the current regulations. The functions implemented and the possibility of further expansion ensure that it is prepared for any developments to the protection system.

The PMVF 80 equipment is supplied already programmed and assembled. With the factory settings, once the connections have been made, it is ready for operation in compliance with the requirements of VDE-AR-N 4105 application guide without requiring any further settings to be made. It is nevertheless prepared for any future changes to the operating parameters.

Changes to the settings are password protected, preventing tampering by unauthorised personnel. In case of damage or malfunctioning the device shall be returned to LOVATO Electric.

## DESCRIPTION

- Modular construction for DIN rail, 6 units.
- LCD graphic 128x80 pixel, backlit, 4 grey levels.
- Display and setting buttons.
- Voltage measuring inputs three-phase + neutral.
- Possibility of operation in the following line configurations:
  - Three-phase with neutral, VL-L voltage controls;
  - Three-phase with neutral, VL-N voltage controls;
  - Three-phase with neutral, VL-N + VL-L voltage controls (default);
  - Three-phase without neutral, VL-L voltage controls;
  - Single-phase, VL-N voltage control.
- 2 switching relay outputs to control:
  - OUT1: IS (Interface Switch) coil control;
  - OUT2: backup device control.
- 4 contact digital inputs for:
  - INP1: IS feedback input;
  - INP2: R.O.C.O.F and Vector Shift monitoring function inhibition;
  - INP3: interface protection disabling signal;
  - INP4: remote tripping control input.
- Optional power unbalance limit (LSP) threshold control (current transformers required).  
Two possible modes:
  - IS trip (OUT1) when LSP exceeded;
  - Separate output switching (OUT3) on additional expansion module for LSP trip indication.
- Settings lock via 2-level changeable password.
- Optional additional measurements, via connection of external CTs:
  - Currents;
  - Powers;
  - Energies supplied.
- Setup for future installation of Interface module.
- Programmable multifunctional output (OUT4) on additional expansion module.

## TRIP THRESHOLDS

- The voltage and frequency trip thresholds for which the equipment is set up according to the factory defaults are listed below. They correspond to the default requirements of VDE-AR-N 4105 application guide. PMVF 80 can be set to P≤50kW or P>50kW cases by specific commands available in the command menu.

Voltage threshold	Default (P≤50kW)		Default (P>50kW)	
	Default (%)	Default (s)	Default (%)	Default (s)
U max U>>	115	0.10s	125	0.10s
U max U>	110	0.10s	110	0.10s
U min U<	80	0.10s	80	1.0s
U min U<<	OFF	0.30s	45	0.30s

Frequency threshold	Default (P≤50kW)		Default (P>50kW)	
	Default (Hz)	Default (s)	Default (%)	Default (s)
f max f>>	OFF	0.10s	OFF	0.10s
f max f>	51.5	0.10s	51.5	0.10s
f min f<	47.5	0.10s	47.5	0.10s
f min f<<	OFF	0.10s	OFF	0.10s

Loss of mains thresholds (islanding detection)	Default	Validation time (cycles)	Delay (s)
R.O.C.O.F (rate of change of frequency)	2Hz/s	0.50s (25)	0.00s
Vector shift	OFF	0.50s (25)	0.00s

The thresholds used during IP operation and the corresponding delays are displayed in a dedicated video page:

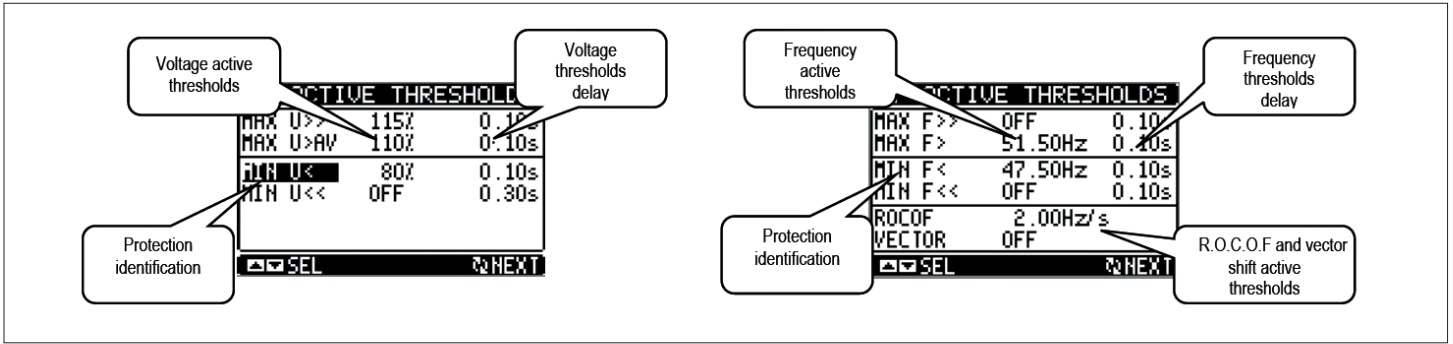

**FRONT BUTTON FUNCTIONS**

**MENU button** - Used to enter or exit the various display and setup menus.

**Buttons ▲ and ▼** - Used to scroll between screens, select from available options on the display and change (increase/decrease) settings.

**Button ✓** - Used to scroll sub-pages, confirm selected options and switch between display modes.

**DISPLAYING MEASUREMENTS**

The ▲ and ▼ buttons allow the measurement display pages to be scrolled one at a time. The current page is shown on the title bar.

The first page displayed (main page) contains all the most important information in both numerical and graphical form. The limit thresholds are indicated by a small marker above the graphic bar, while the arrows under the graphic bar indicate the measurement range (HI – LO).

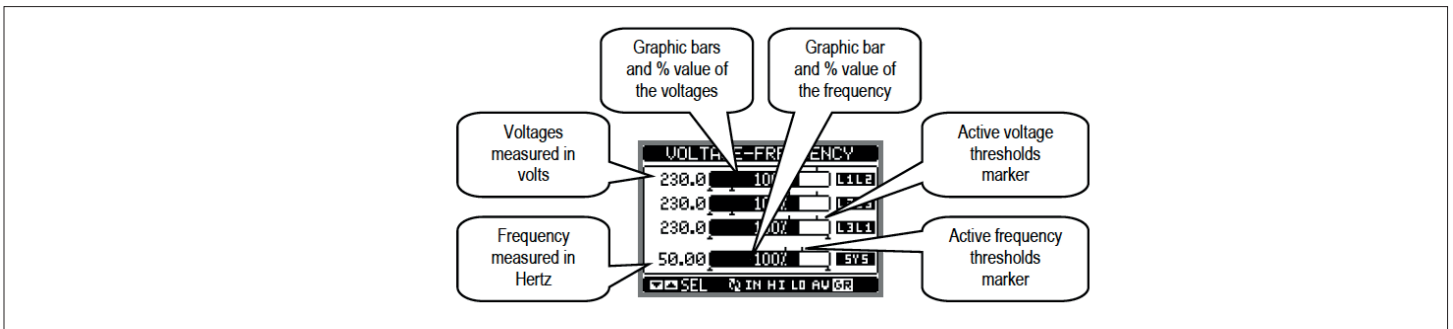

The next page displays an overview of the state of the Interface Protection System, showing both the state of the outputs to the IS and backup and the state of the control inputs. The black arrows indicate an active state, the grey ones an inactive state.

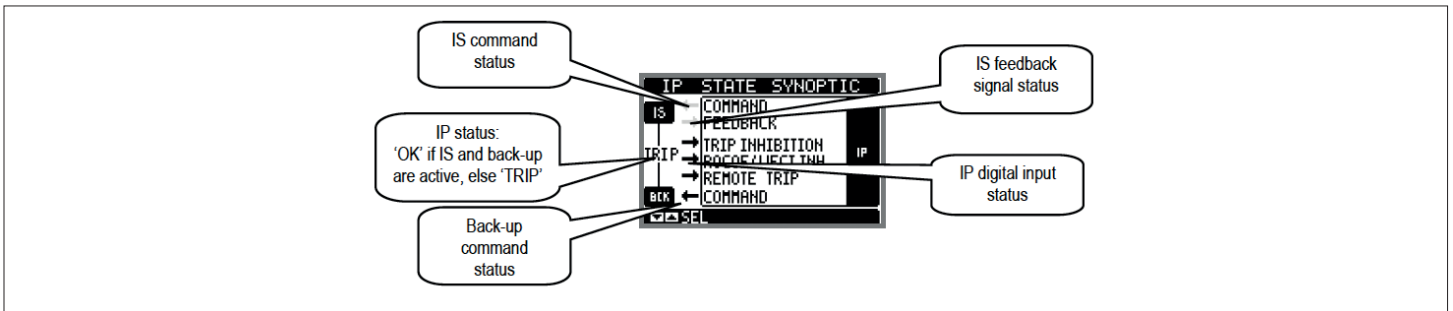

Three pages with trip protection counters follow, divided into total trip count, voltage threshold trip count and frequency threshold trip count. The counters can be reset through the Commands Menu.

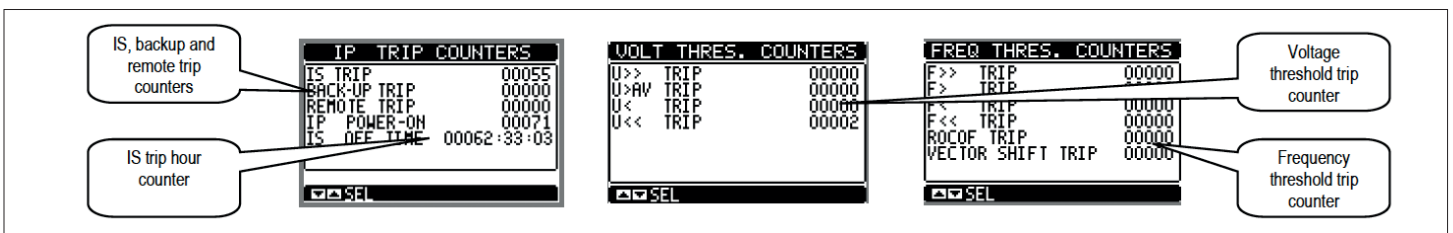

Some measurements may not be displayed, depending on the programming and the connection for the device (for example, if programmed for a system without neutral, the measurements relating to neutral are not displayed).

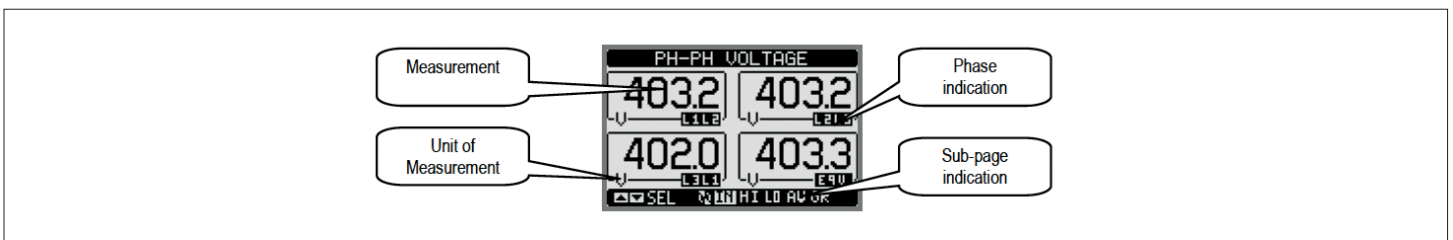

- For many pages, the ✓ button permits access to sub-pages (for example, to display the maximum and minimum values recorded).
- The sub-page displayed currently is indicated at the bottom left by one of the following icons:
  - **IN = Instantaneous value** – Current instantaneous value of the measurement, displayed by default every time the page is changed.
  - **HI = Maximum instantaneous value** – Highest value measured by the IP for the corresponding measurement. HIGH values are stored and preserved even in the absence of a power supply. They can be reset through a dedicated command (see COMMANDS MENU).
  - **AV = Average value** – Average value of the measurements, with slowed variations (average of the last minute).
  - **LO = Minimum instantaneous value** – Lowest value measured by the IP from the moment voltage is applied. It is reset with the same command used for the HI values.
  - **GR = Graphic bars** – Display of measurements through graphic bars.
- The user can specify the page and sub-page to return to automatically after no buttons have been pressed for a given time.
- It is also possible to program PMVF 80 so that the display always remains that which was last selected.
- For the setup of these functions, see MENU M02 – UTILITY.

TABLE OF DISPLAY PAGES

No.	Selection via ▲ and ▼ PAGES	Selection via ✓ SUB-PAGES			
		HI	LO	AV	GR
1	<b>VOLTAGES, FREQUENCY</b> V(L1-L2), V(L2-L3), V(L3-L1), F(Hz)				
2	<b>IP STATE SYNOPTIC</b> STATE OF IS/BACKUP CONTROL OUTPUTS, FEEDBACK INPUT, R.O.C.O.F/VECTOR SHIFT INHIBIT INPUT, IP DISABLING INPUT, REMOTE TRIPPING				
3	<b>ACTIVE THRESHOLDS – DELAYS IN USE</b> VOLTAGE THRESHOLDS AND DELAYS CURRENTLY ACTIVE	FREQUENCY THRESHOLDS AND DELAYS CURRENTLY ACTIVE R.O.C.O.F – VECTOR SHIFT			
4	<b>IP TRIP COUNTER</b> IS TRIP CNT, BACKUP TRIP CNT, REMOTE TRIP CNT, POWER-ON CNT, IS OFF TIME				
5	<b>VOLTAGE THRESHOLD TRIP COUNTERS</b> U>>, U>, U<, U<< CNT				
6	<b>FREQUENCY THRESHOLD TRIP COUNTERS</b> f>>, f>, f<, f<<, R.O.C.O.F TRIP, VECTOR SHIFT TRIP CNT				
7	<b>PHASE-TO-PHASE VOLTAGES</b> V(L1-L2), V(L2-L3), V(L3-L1), V(LL)EQV	HI	LO	AV	GR
8	<b>PHASE-TO-NEUTRAL VOLTAGES</b> V(L1-N), V(L2-N), V(L3-N), V(L-N)EQV	HI	LO	AV	GR
9	<b>MOVING AVERAGE VOLTAGE</b> VM(L1-L2), VM(L2-L3), VM(L3-L1) OR VM(L1-N), VM(L2-N), VM(L3-N)	HI	LO		
10	<b>PHASE AND NEUTRAL CURRENTS</b> I(L1), I(L2), I(L3), I(N)	HI	LO	AV	GR
11	<b>ACTIVE POWER</b> P(L1), P(L2), P(L3), P(TOT)	HI	LO	AV	GR
12	<b>ACTIVE POWER IMBALANCE</b> kW P1-P2, kW P2-P3, kW P3-P1	HI	LO	AV	GR
13	<b>TREND GRAPH</b> P(TOT) LAST 24h				
14	<b>ACTIVE ENERGY – ACTIVE POWER – BAR GRAPH</b> kWh (TOT) – kW (TOT) – BAR GRAPH kW(TOT)				
15	<b>REACTIVE POWER</b> Q(L1), Q(L2), Q(L3), Q(TOT)	HI	LO	AV	GR
16	<b>APPARENT POWER</b> S(L1), S(L2), S(L3), S(TOT)	HI	LO	AV	GR
17	<b>POWER FACTOR</b> PF(L1), PF(L2), PF(L3), PF(TOT)	HI	LO	AV	GR
18	<b>ENERGY METERS</b> kWh+(TOT), kWh-(TOT), kvarh+(TOT), kvarh-(TOT), kVA(TOT)	PARTIAL			
19	<b>ENERGY METERS PHASE L1</b> kWh+L1(TOT), kWh-L1(TOT)	PARTIAL			
20	<b>ENERGY METERS PHASE L2</b> kWh+L2(TOT), kWh-L2(TOT)	PARTIAL			
21	<b>ENERGY METERS PHASE L3</b> kWh+L3(TOT), kWh-L3(TOT)	PARTIAL			
10	<b>EVENT LOG</b>	EVENT SCROLLING (128 EVENTS)			
22	<b>EXPANSION MODULES</b>				
23	<b>INFO-REVISION-SERIAL NO.</b> MODEL, REV SW, REV HW, SER. No.				
24	<b>LOGO</b>				

- **Note:** some of the pages listed above may not be displayed, if the function displayed is not enabled. For example, if external CTs are not connected and programmed, the pages highlighted in grey are not displayed.
- **Note:** the moving average voltage measurement is not available for the first 10 minutes after switching on or resetting the system. During this time, dashes and a countdown indicating the time left before measurement display are shown.

MAIN MENU

- The main menu consists of a set of graphic icons which allow rapid access to measurements and settings.
- Starting from the normal measurement display, press the **MENU** button. The display shows the quick menu (see figure below).
- Press **▲** or **▼** to select the desired function. The selected icon is highlighted and the message in the middle of the display indicates the description of the function.
- Press **✓** to activate the selected function.
- If some functions are not available, the corresponding icon will be deactivated, i.e. greyed out.
- etc. Operate as shortcuts which allow quicker access to pages for displaying measurements, going directly to the selected group of measurements, from which it is possible to move forwards and backwards as usual.
- - Setting the numeric code which permits access to protected functions (setting parameters, executing commands).
- - Parameter programming access point.
- - Commands Menu access point, where authorised users can perform a number of resetting and restoring operations.

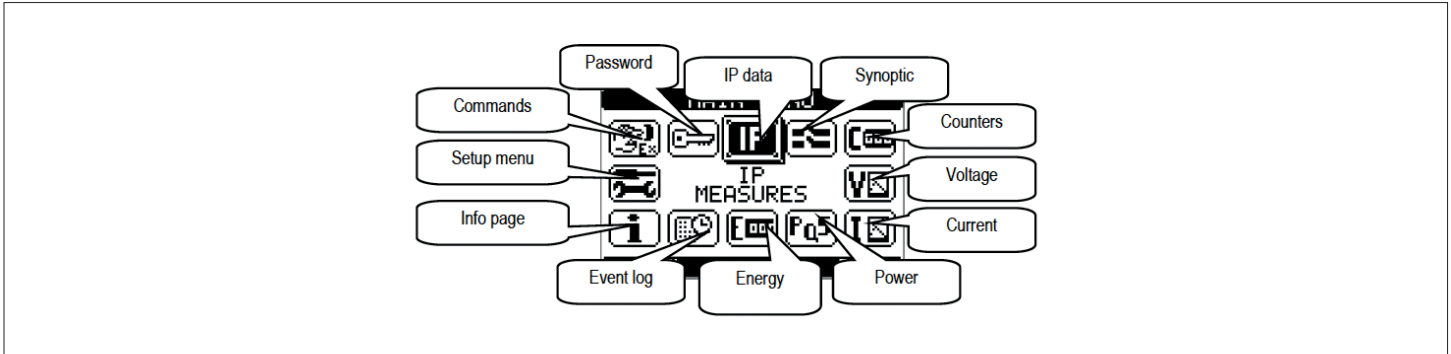

PASSWORD-PROTECTED ACCESS

- For new (default) equipment, the password is enabled with the default 1000 (user access) and 2000 (advanced access) codes.
- To modify the access codes, refer to the Setting Parameters (setup) section.
- There are two access levels, depending on the code entered:
  - **User-level access** - permits resetting of the recorded values and modifying of some settings values (see parameter list in Setting Parameters section);
  - **Advanced-level access** - the same rights as user, with the addition of being able to change all the settings.
- In the normal measurements display, press **MENU** to recall the main menu, then select the password icon and press **✓**.
- The password setting window shown below will appear:

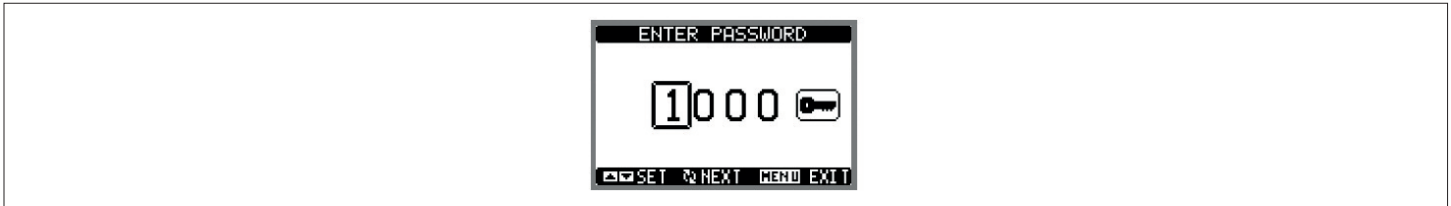

- Press the **▲▼** buttons to change the value of the selected digit.
- Press the **✓** button to confirm the digit and cycle to the next ones.
- Enter the password, then go to the key icon. The parameters in italic font can be accessed with advanced password only.
- When the password entered corresponds to the User-level or Advanced-level password, the appropriate unlock message appears.
- After the password is unlocked, access will remain enabled until:
  - The equipment is disconnected;
  - The equipment is reset after exiting the Setting Parameters (setup) menu;
  - 2 minutes elapse without the operator touching any button.
- Press **MENU** button to stop setting the password and exit.

SETTING PARAMETERS (SETUP)

- From the standard measurement display, press **MENU** to call up the main menu, then select the icon and press **✓** to access the Setting Parameters (setup) menu.
- The table in the figure is displayed, for selecting the set-up sub-menus, in which all the parameters are grouped according to their function.
- Press the **▲▼** buttons to select the desired menu and press **✓** to confirm.
- Press **MENU** to exit and return to the measurement display.
- The available sub-menus are listed in the following table :

Code	MENU	DESCRIPTION
M01	GENERAL	Specifications of the system
M02	UTILITY	Language, brightness, display pages, etc.
M03	PASSWORD	Enablement of protected access
M04	IP THRESHOLDS	IP trip thresholds and delays
M05	COMMUNICATION (COMn)	Communication ports
M06	ALARMS	Alarm enable

- Select the sub-menu and press the **✓** button to display the parameters.
- All parameters are displayed with code, description, current value.



- To change the value of a parameter, select it then press  $\checkmark$ .
- The right of access to the parameters depends on the entered password level. Some parameters require user level password only, others require the advanced level password according to what VDE-AR-N 4105 states.
- If access has been granted, on the other hand, the modification page will be displayed.



- In modification mode, the value can be changed with the  $\blacktriangle$  and  $\blacktriangledown$  buttons. Also displayed are a graphic bar indicating the setting range, the minimum and maximum values possible, the previous value and the default value.
  - Pressing  $\blacktriangle$  and  $\blacktriangledown$  simultaneously restores the factory default value.
  - Press **MENU** to return to parameter selection. The value entered is stored.
  - Press **MENU** again to save the changes and exit setup. The IP resets and resumes normal operation.
- ATTENTION:** When restarting following a change to the parameters or commands, the output relays are temporarily de-energised.
- If no buttons are pressed for 2 minutes, the set-up menu is abandoned automatically and the IP returns to the standard display.

## PARAMETER TABLE

M01 - GENERAL		UoM	Default	Range
P01.01	Rated voltage	V	400	50 – 50000
P01.02	VT primary	V	OFF	OFF/100 – 50000
P01.03	VT secondary	V	110	50 - 500
P01.04	CT primary	V	OFF	OFF/1-10000
P01.05	CT secondary	A	5	1-5
P01.06	Voltage connection / control		3-phase+N / VLL-N	3-phase+N / VL-L 3-phase+N / VL-N 3-phase / VL-L 1-phase / VL-N 3-phase+N / VLL-N
P01.07	Rated system power	kW	AUT	AUT/ 1-10,000
P01.08	IS activation delay time after switching on IP	s	60,00	4,00 – 300,00
P01.09	Power imbalance limit LSP control output		OUT3	OFF OUT1 OUT3 OUT1 + OUT3
P01.10	LSP threshold 1	kW	6.0	OFF / 1.0 – 100.0
P01.11	LSP delay time 1	s	1,800	1 - 3,600
P01.12	LSP threshold 2	kW	10.0	OFF / 1.0 – 200.0
P01.13	LSP delay time 2	s	60	1 - 3,600
P01.14	Automatic LSP restore time	s	3.0	1.0 - 60.0
P01.15	OUT4 output function		Global Alarm	OFF IS Backup LSP Global Alarm Threshold U> Threshold U>> Threshold U< Threshold U<< Threshold f> Threshold f>> Threshold f< Threshold f<< Alarm A01 Alarm A02 Alarm A03 Alarm A04 Alarm A05 Alarm A06
P01.16	Backup control mode		MODE A	OFF MODE A MODE B MODE C MODE D
P01.17	Backup control pulse duration	s	3.0	1.0-60.0
P01.18	INP4 remote tripping normal status		NO	NO NC

**P01.01** – Rated voltage: set VLN value in case of P01.06 = 3-phase+N / VL-N or P01.06 = 1-phase / VL-N, set VLL value otherwise.

**P01.02** – Rated voltage of VT primary winding.

**P01.03** – Rated voltage of VT secondary winding.

**P01.04** – Rated current of CT primary winding. If CTs are not fitted, leave at OFF. The pages on currents and powers are displayed only when CTs are used.

**P01.05** – Current of CT secondary winding.

**P01.06** – Type of connection and type of voltage control. Program in line with the wiring.

**P01.07** – Rated active power of system. If set to AUT, the value is calculated by multiplying P01.04 \* “rated VLN” \* 3 (phase current \* phase voltage \* 3 phases).

**P01.08** – IS energising delay time after applying voltage to PMVF 80.

**P01.09** – LSP protection control output selection – On OUT1 (IS opening), independent on OUT3 or on both.

**P01.10-11** – First-level LSP (LSP1) threshold and delay.

**P01.12-13** – Second-level LSP (LSP2) threshold and delay.

**P01.14** – Defines the automatic restore time after LSP tripping. If set to off, the system can only be restored manually by pressing the ▲ ▼ buttons.

**P01.15** – Defines the function of the OUT4 output from those listed. The output is understood to be activated when conditions are normal (threshold not exceeded, alarm not active, etc.).

**P01.16** – Defines the backup control mode, according to the logic in the Backup Activation Modes diagram on the final pages of this manual. If the backup is not used, set to OFF.

**P01.17** – Backup opening pulse duration, when used in MODE C.

**P01.18** – Normal status for remote tripping input.

M02 – UTILITY		UoM	Default	Range
P02.01	Language		English	English Italian
P02.02	LCD contrast	%	60	0-100
P02.03	Display backlighting intensity high	%	100	0-100
P02.04	Display backlighting intensity low	%	30	0-50
P02.05	Low backlight delay	s	30	5-600
P02.06	Default page return	s	60	OFF / 10-600
P02.07	Default page		SPI MEASURES	Page list at page 4
P02.08	Default sub-page		GR	IN / HI / LO / AV / GR
P02.09	Display update time	s	0.5	0.1 – 5.0

**P02.06** – If set to OFF, the display always remains on the page where the user left it. If set to a value, after this time the display returns to the page set with P02.07.

**P02.07** – Abbreviation for the start page on switching on and that the display returns to automatically once the time P02.06 since a button was last pressed has elapsed.

**P02.08** – Type of sub-page that the display returns to after P02.06 has elapsed.

M03 – PASSWORD		UdM	Default	Range
P03.01	Enable passwords		ON	OFF-ON
P03.02	User-level password		1000	0-9999
P03.03	Advanced-level password		2000	0-9999

**P03.01** – If set to OFF, password management is disabled.

**P03.02** – With P03.01 active, value to specify to activate user-level access.

**P03.03** – With P03.01 active, value to specify to activate advanced-level access.

M04 – IP THRESHOLDS		UoM	Default	Range
P04.01	UMAX U>> Threshold	%	115 (P≤50kW) 125 (P>50kW)	OFF – 100...130
P04.02	UMAX U> Threshold	%	110	OFF – 100...120
P04.03	UMIN U< Threshold	%	80	OFF – 20...100
P04.04	UMIN U<< Threshold	%	OFF (P≤50kW) 45 (P>50kW)	OFF – 5...100
P04.05	UMAX U>> Delay	s	0.10	0.05 - 1.00
P04.06	UMAX U> Delay	s	0.10	0.05 - 100,00
P04.07	UMIN U< Delay	s	0.10 (P≤50kW) 1.00 (P>50kW)	0.05 - 5.00
P04.08	UMIN U<< Delay	s	0.30	0.05 - 5.00
P04.09	F MAX f>> Threshold	Hz	OFF	OFF / 49.91 - 53.00
P04.10	F MAX f> Threshold	Hz	51.50	OFF / 49.91 - 53.00
P04.11	MIN f< Threshold	Hz	47.50	OFF / 45.01 - 50.00
P04.12	F MIN f<< Threshold	Hz	OFF	OFF / 45.01 - 50.00
P04.13	F MAX f>> Delay	s	0.10	0.05 - 5.00
P04.14	F MAX f> Delay	s	0.10	0.05 - 100,00
P04.15	F MIN f< Delay	s	0.10	0.05 - 100,00
P04.16	F MIN f<< Delay	s	0.10	0.05 - 5.00
P04.17	Backup energizing delay	s	0.5	0.1 – 10.0
P04.19	IP Restore delay	s	60.00	0.04 – 300,00
P04.20	U> Type	s	AVG	AVG INST
P04.21	R.O.C.O.F threshold	Hz/s	2.00	OFF / 0.01 – 5.00
P04.22	Validation cycles		25	5-50
P04.23	Vector Shift Threshold	°	OFF	OFF / 1 - 50
P04.24	R.O.C.O.F dead zone	Hz	0.10Hz	OFF / 0.01 – 0.50
P04.25	R.O.C.O.F delay	s	0.00	0.00 - 2.00
P04.26	Vector shift delay	s	0.00	0.00 - 2.00
P04.27	R.O.C.O.F / Vector shift delay on INP2	s	2.00	0.00 - 5.00
P04.28	UMAX reset threshold	%	110	100 – 130
P04.29	UMIN reset threshold	%	85	20 – 100
P04.30	FMAX reset threshold	Hz	50.10	49.91 - 53.00
P04.31	FMIN reset threshold	Hz	47.55	45.01 - 50.00

**P04.01...P04.16, P04.20...P04.31** – Adjustment of trip thresholds and delay times defined by VDE-AR-N 4105 application guide.

**Note:** in case **P04.23** is set to **OFF** (Vector shift disabled), a delay of **0.05s** minimum is recommended for **P04.25** (R.O.C.O.F delay) to avoid unexpected trip for R.O.C.O.F when a vector shift event occurs.

**P04.17** – Maximum IS opening waiting time, before IS locking is recognised with consequent backup opening command.

**P04.19** – IS restore (reset) time. IS reclosing delay time after all thresholds are ok again.

M05 – COMMUNICATION		UoM	Default	Range
P05.1.01	Serial node address		01	01-255
P05.1.02	Serial speed	bps	9600	1200 2400 4800 9600 19200 38400
P05.1.03	Data format		8 bit – n	8 bit, no parity 8 bit, odd 8 bit, even 7 bit, odd 7 bit, even
P05.1.04	Stop bits		1	1-2
P05.1.05	Protocol		Modbus-RTU	Modbus-RTU Modbus-ASCII Modbus-TCP
P05.1.06	IP address		000.000.000.000	000.000.000.000 - 255.255.255.255
P05.1.07	Subnet mask		000.000.000.000	000.000.000.000 - 255.255.255.255
P05.1.08	IP port		1001	0-9999
P05.1.09	Gateway function		OFF	OFF/ON

**P05.1.01** – Serial address (node) for the communication protocol.

**P05.1.02** – Communication port bit-rate.

**P05.1.03** – Data format. 7 bit setting position for ASCII protocol only.

**P05.1.04** – Number of stop bits.

**P05.1.05** – Communication protocol selection.

**P05.1.06, P05.1.07, P05.1.08** – TCP/IP details for applications with Ethernet interface. Not used with other communication module types.

**P05.1.09** – Gateway function enable.

M06 – ALARMS		Default	Range
P06.01	Alarm A01 enable	ON	ON - OFF
P06.02	Alarm A02 enable	ON	ON - OFF
P06.03	Alarm A03 enable	ON	ON - OFF
P06.04	Alarm A04 enable	ON	ON - OFF
P06.05	Alarm A05 enable	ON	ON - OFF
P06.06	Alarm A06 enable	ON	ON - OFF

**P06.01...P06.06** – Enables or disables the corresponding alarm.

**Note:** the use of the auxiliary feedback contact on the IS is recommended even in applications where the backup device is not used. If not even the feedback contact is used however, it will be necessary to deactivate alarms A02 and A03 by setting P06.02 and P06.03 to OFF.

#### COMMANDS MENU

- The Commands Menu is used to perform occasional operations, like resetting measurements, counters, alarms, etc.
- If the Advanced-level access password was entered, the Commands Menu can also be used to perform automatic operations useful for configuring the instrument.
- The following table shows the functions which are available with the Commands Menu, divided according to the required access level.

CODE	COMMAND	ACCESS LEVEL	DESCRIPTION
C.01	RESET HI-LO	User / Advanced	Resets the HI and LO values of all measurements
C.02	RESET TRIP COUNTERS	User / Advanced	Resets the trip counters
C.03	RESET PARTIAL ENERGY METERS	User / Advanced	Resets partial energy meters
C.11	RESET TOTAL ENERGY METER	Advanced	Resets total and partial energy meters and tariffs
C.12	PARAMETERS TO DEFAULT P≤50kW	Advanced	Restores all settings to factory default values for plants with P≤50kW
C.13	PARAMETERS TO DEFAULT P>50kW	Advanced	Restores all settings to factory default values for plants with P>50kW
C.14	PARAMETER BACKUP	Advanced	Saves a backup copy of the settings
C.15	PARAMETERS RESTORE	Advanced	Reloads the settings from the backup copy
C.16	INHIBITION U> UMAX	Advanced	Temporarily disables U> for U>> threshold test U> threshold enables after 1 hour time or a device reboot
C.17	INHIBITION U< UMIN	Advanced	Temporarily disables U< for U<< threshold test U< threshold enables after 1 hour time or a device reboot
C.18	RESET EVENT LOG	Advanced	Reset the event log



## ALARM INDICATIONS AND EVENT LIST

- In the event of an anomaly, the PMVF 80 indicates the situation with a pop-up window.
- If the user presses buttons on the front, the alarm is hidden temporarily to permit consultation of the screens.
- The alarm remains while the anomaly is present.

CODE	ALARM / INDICATION	DESCRIPTION / POSSIBLE CAUSES
A02	IS OPENING FAILURE	The IP sends the opening command to the IS, but the auxiliary (feedback) contact is closed, so the IP sends an opening command to the. Check the operation of the IS and of its auxiliary (feedback) contact. <b>A02 alarm is retentive because it is an "IP system fault". Restore the feedback proper operation, then switch OFF and on the IP to reset the alarm.</b>
A03	IS CLOSING FAILURE	<ul style="list-style-type: none"> <li>- The IP has ordered the closing of the IS but it does not close (check OUT1 wiring and/or IS coil).</li> <li>- The auxiliary IS contact (feedback) is not working.</li> <li>- The auxiliary IS contact (feedback) is not connected correctly to terminal INP1.</li> <li>- The auxiliary IS contact (feedback) is not fitted since it is not envisaged in the scheme.</li> </ul> Disable alarm A03 by setting P06.03 to OFF. Note: LOVATO Electric recommends the use of the feedback input. <b>A03 alarm is retentive because it is an "IP system fault". Restore the feedback proper operation, then switch OFF and on the IP to reset the alarm.</b>
A04	INCORRECT MODULE HW CONFIGURATION	PMVF 80 has not found the required expansion modules. Check that they are configured correctly at the side.
A05	LSP1 TRIP - PRESS ▲ ▼ TO RESTORE	Power Imbalance Limit protection LSP1 has tripped. Automatic time-based or manual reset.
A06	LSP2 TRIP - PRESS ▲ ▼ TO RESTORE	Power Imbalance Limit protection LSP2 has tripped. Automatic time-based or manual reset.

- All the alarms/warnings except A04 are non-retentive, i.e. they reset when the anomaly is no longer present after the corresponding reset times.
- In the presence of a non-retentive alarm, the equipment continues to operate in any case.
- Exit OUT4 can be programmed to indicate the presence of any alarm (global alarm function).
- In addition to alarm indication, an event list is available with the following cases. The event is reported with description, the time elapsed from the latest power on and the number of total power on.

SYSTEM
POWER ON
POWER DOWN
REBOOT
COMMAND MENU
C12 DEFAULT P<=50kW
C13 DEFAULT P>50kW
C14 BACKUP SETUP
C15 RESTORE SETUP
C18 RESET EVENT LOG
PASSWORD ENTRY
USER LEVEL
ADVANCED LEVEL
SETUP ACCES

IS TRIP
U<< TRIP
U< TRIP
U>> TRIP
U> TRIP
U> AV TRIP
F<< TRIP
F>> TRIP
F< TRIP
F> TRIP
R.O.C.O.F TRIP
VECTOR SHIFT TRIP
REMOTE TRIP

## SELF-DIAGNOSIS

- The PMVF 80 features a series of self-diagnosis checks. If any of these checks is unsuccessful, a window displaying the text System Error Exx is displayed, where xx indicates the reason for malfunction. Should this indication occur, contact our Technical Support office (Tel. + 39 035 4282422; E-mail: service@LovatoElectric.com), stating the code indicated.

## CURRENT, POWER AND ENERGY MEASUREMENTS

- If CTs are connected to the current inputs and their reading is enabled by setting parameter P01.04 to a value other than OFF, the equipment will measure currents, powers and energies that, depending on where the CTs are positioned may refer to energy exchange (CTs positioned on the delivery point) or to the energy produced (CTs positioned on generator line).
- The active power produced (exported, i.e. transferred to the grid) will be displayed with conventional minus sign (e.g. - 6.5kW). The quantity of energy produced by the generator will be added to the exported energy meter.

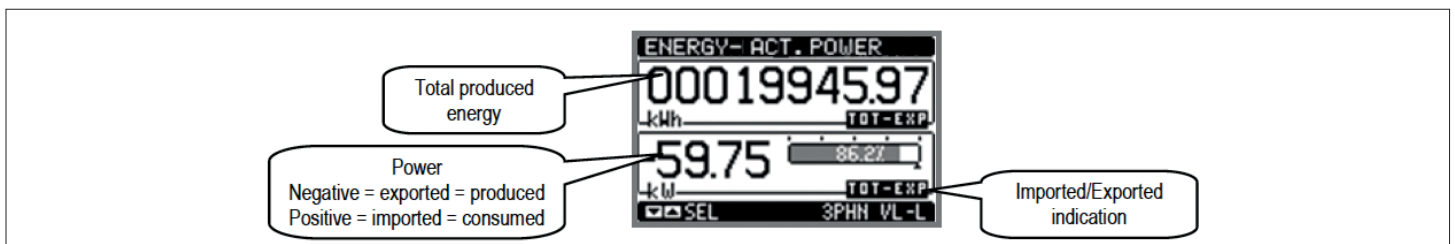

- There is also a page called Trend Graph which displays the trend in energy production in the last 24 hours (see below).

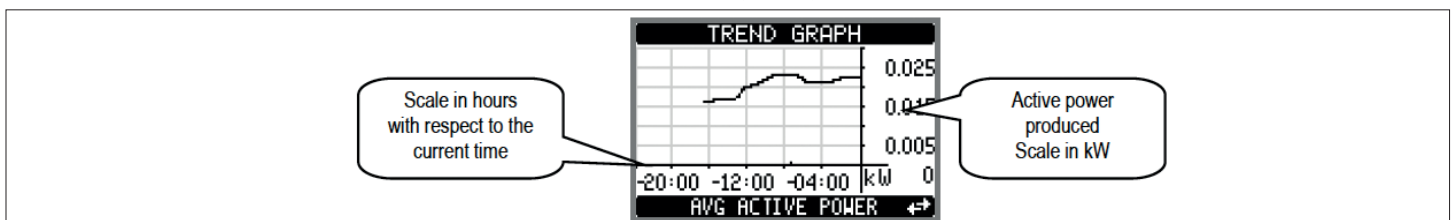

- The power measurements permit monitoring of the generator production parameters and making them available on the display or to any supervision system that can read them through one of the supported optional communication modules.

## POWER UNBALANCE LIMIT (LSP) CONTROL

- In three-phase+neutral systems, with CTs installed, the PMV F80 can also be programmed to carry out the Power Unbalance Limit (LSP) function.
- In this case, when an unbalance is measured between the phase active powers (difference between the highest and lowest powers) of more than 6kW for a time > 30mins or an unbalance of more than 10kW for a time > 1min, LSP protection trips.

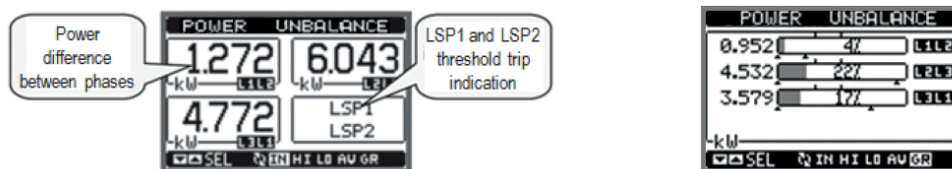

- This protection can be programmed to open relay OUT3 or to open the IS via output OUT1.
- See setup parameters P01.09 to P01.14.
- LSP protection tripping is highlighted by A05 and A06 appearing on the display (for LSP1=6kW and LSP2=10kW imbalance thresholds respectively).
- It is possible to restore manually by pressing the ▲ ▼, buttons simultaneously, or automatically by waiting for the time set with P01.14.

## COMMUNICATION

- The PMV F80 can be fitted with an optional standard communication module from those listed below. When a communication module is installed, it must be configured through the dedicated M05 - COMMUNICATION MENU.
- The protocol currently supported is Modbus in the RTU, ASCII and TCP variants.
- The equipment is already prepared for communication in accordance with the IEC/EN 61850, possible via installation of a dedicated module.

MODULE TYPE	CODE	FUNCTION	MAX. No.
COMMUNICATION	EXM10 10	USB	1
	EXM10 11	RS232	
	EXM10 12	RS485	
	EXM10 13	ETHERNET	

## WIRING DIAGRAMS

## Three-phase connection

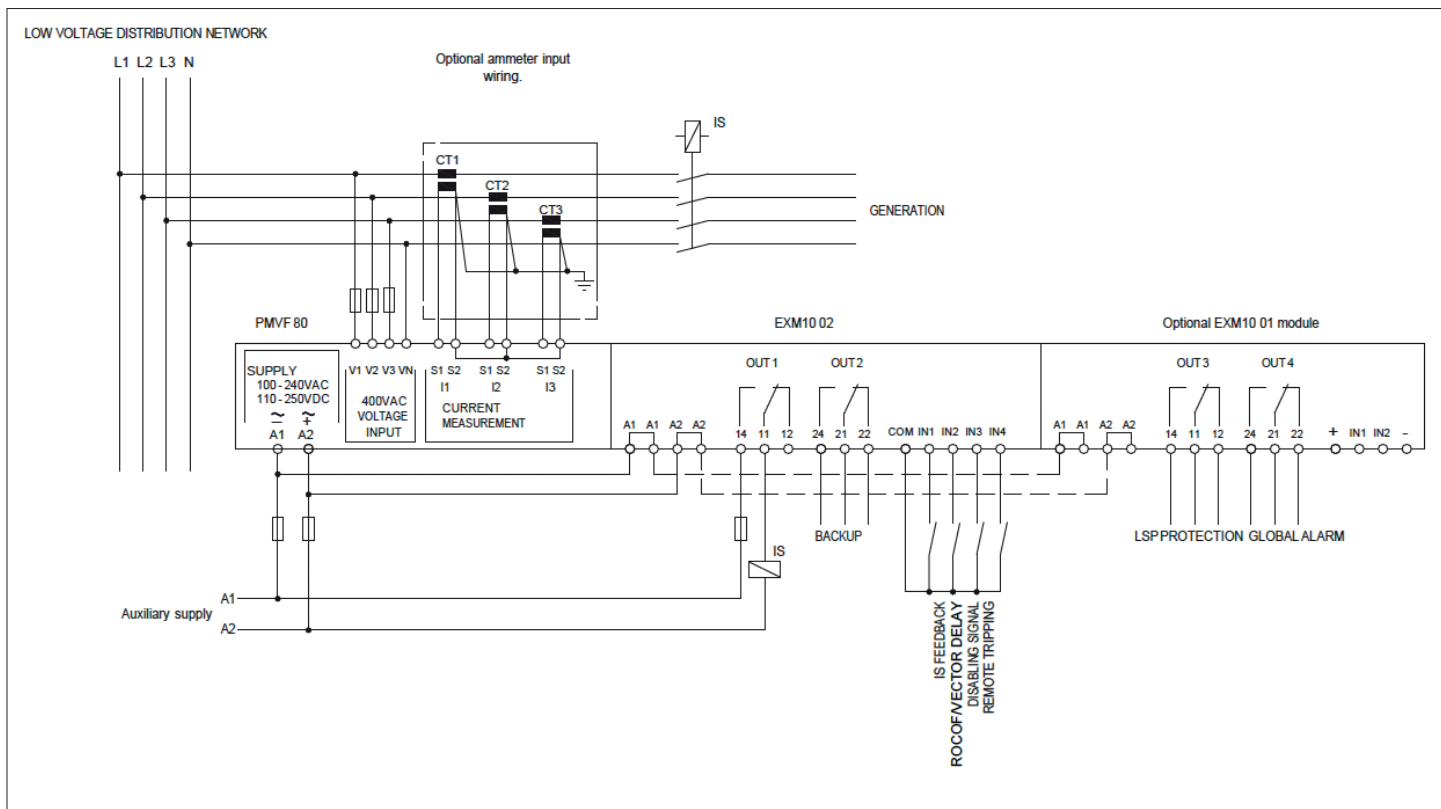

- Recommended fuses:
  - Auxiliary supply and voltage measurement input: F1A (fast);
  - Contactor control: MAX F5A (fast).
- IS and BACKUP coils must be connected to NO contacts (14) of OUT1 and OUT2 (24).
- The S2 terminals are connected to each other internally.
- The auxiliary IS contact (feedback) must of necessity be connected.
- In the case of multiple ISs, the IS feedback contact must be a parallel connection of all the ISs' auxiliary contacts.
- In single-phase wiring, connect terminal V3 to VN.
- Class 1 current transformers are recommended.



**ATTENTION: terminals A1 and A1 of EXM... modules are connected internally, as are terminals A2 and A2.**

The free A1 and A2 terminals can be used solely for supplying other EXM... modules (Max. 3). Maximum current 500mA. Maximum protection fuse current: F1A.

		P01.05	P01.05	P04.19	P04.17	P01.14
IP SUPPLY						
V/FOK						
ISOUT1	11					
	14					
	12					
IS INP1						
BACKUP P01.13						
MODE A (default)	21					
	24					
	22					
MODE B	21					
	24					
	22					
MODE C	21					
	24					
	22					

Note: the default backup control mode is A. If mode D is selected, Backup output mirrors the IS output. See parameter P01.16 (M01 - GENERAL MENU on page 6).

TERMINAL LAYOUT

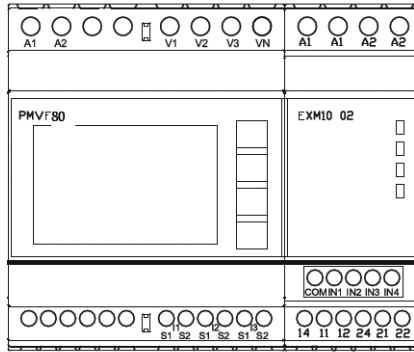

MECHANICAL DIMENSIONS [MM]

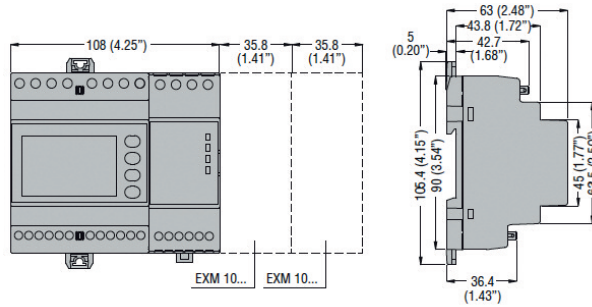

MOUNTING INSTRUCTION

DEMOUNTING INSTRUCTION

DEVICE SYMBOLS

Warning: read the present instruction manual

WAEE/RAEE: waste electronic equipment to be separately collected

## TECHNICAL CHARACTERISTICS

**Auxiliary supply**

Rated voltage Us	100 - 240V~ 110 - 250V=
Operating range	85 - 264V~ 93.5 - 300V=
Frequency	45 - 55Hz
Power consumption/dissipation	Us 110V~ 4.6VA 2.5W max Us 230V~ 12.5VA 2.7W max Us 110V= 23mA 2.3W max Us 250V= 11mA 2.5W max
Immunity time for microbreakings	≤200ms con Us 240V~ ≤ 50ms con Us 100V~
Rated insulation voltage Ui	250V~
Overtoltage category	II
Insulation	Test type Uimp AC 50Hz 4.8kV 2kV

**Voltmeter inputs**

Input type	Three-phase + neutral
Max. rated voltage Ue	400V~ phase-to-phase 230V~ phase-to-neutral
Measuring range	20 - 480V~ phase-to-phase 10 - 276V~ phase-to-neutral
Rated frequency	50Hz
Frequency range	45 - 55Hz
Measurement type	True root mean square (TRMS)
Connection method	Three-phase with or without neutral
Rated insulation voltage Ui	400V~
Overtoltage category	III
Insulation	Test type Uimp AC 50Hz 7.3kV 2kV

**Ammeter inputs (optional)**

Rated current Ie	1A~ or 5A~
Measuring range	for 5A scale: 0.010 - 6A~ for 1A scale: 0.010 - 1.2A~
Input type	Shunt supplied by an external current transformer (low voltage) 5A max.
Measurement type	Root mean square (RMS)
Overload capacity	+20% In
Overload peak	50A for 1 second
Burden (per phase)	0.6W

**Accuracy**

Measuring conditions	
Temperature	+23°C ±2°C
Phase voltage	± 0.2% (160...480V~) ±0.5 digit ± 0.5% (50...160V~) ±0.5 digit
Phase-to-phase voltages	± 0.2% (277...830V~) ±0.5 digit ± 0.5% (80...277V~) ±0.5 digit
Current	± 0.2% (0.1...1.2In) ±0.5 digit
Active energy	Class 0.5s (IEC/EN 62053-22)
Reactive energy	Class 2 (IEC/EN 62053-23)

**Additional errors**

Temperature	0.03%/°K per V, A, W
-------------	----------------------

**Relay outputs**

Number of outputs	<b>2</b>
Output type	1 switching contact
Rated operating voltage	250V~
IEC/EN 60947-5-1 designation	C300 / NO contact AC1 5A 250V~ - 5A 30V= NC contact AC1 2A 250V~ - 2A 30V=
Electrical endurance	NO contact 2x10 <sup>4</sup> operations NC contact 10 <sup>4</sup> operations
Mechanical life	10 <sup>7</sup> operations
Overtoltage category	II
Insulation	Test type Uimp AC 50Hz 4.8kV 2kV

**Digital inputs**

Number of inputs	4
Input type	Positive (PNP)
Voltage present on inputs	12V= isolated
Input current	7mA
Low input signal (ON)	≤1.5V (2.9V typical)
High input signal (OFF)	≥5.3V (4.3V typical)
Rated insulation voltage Ui	12V=

**Ambient conditions**

Operating temperature	-20...+40°C
Storage temperature	-30...+80°C
Relative humidity	<80% (IEC/EN 60068-2-78)
Maximum degree of ambient pollution	2
Atmospheric pressure	80-101kPa
Altitude	≤2000m

**Voltage measurement (V1 - V2 - V3 - N terminals)/ Auxiliary supply circuit connections (A1 - A2 terminals)**

Terminal type	Screw-type (fixed)
No. of terminals	2 + 4 for supply 4 for voltage measurement
Cable cross section (min. - max.)	0.2...4.0mm <sup>2</sup> (24 - 12AWG)
Tightening torque	0.8Nm (7lb.in)

**Current measurement circuit connections**

Terminal type	Screw-type (fixed)
No. of terminals	6
Cable cross section (min. - max.)	0.2...2.5mm <sup>2</sup> (24 - 12AWG)
Tightening torque	0.44Nm (4lb.in)

**Relay output connection**

Terminal type	Screw-type (fixed)
No. of terminals	6
Cable cross section (min. - max.)	0.2...2.5 mm <sup>2</sup> (24 - 12AWG)
Tightening torque	0.44Nm (4lb.in)
Isolation between the 2 relay outputs	Screw-type (fixed)

**Digital input connection**

Terminal type	Screw-type (removable)
No. of terminals	5
Cable cross section (min. - max.)	0.2...2.5mm <sup>2</sup> (24 - 12AWG)
Tightening torque	0.5Nm (4.5lb.in)

**Housing**

Version	6 modules (DIN 43880)
Fitting	35mm rail (IEC/EN 60715) or screw-type by means of clips removable
Material	Polyamide RAL 7035
Degree of protection	IP40 front IP20 housing and terminals
Weight	580g

**Certifications and compliance**

Compliance with standards	VDE-AR-N 4105 application guide, VDE V 0126-1-1 application guide, IEC/EN 61010-1, IEC/EN 61000-6-2, IEC/EN 61000-6-4
---------------------------	---

① Single insulation between the relays. Both the relay outputs must be used with the same voltage source.

