



- Przeznaczone do rozłączania, przełączania, włączania i wyłączania oraz uruchamiania silnika
- Możliwość zamówienia wykonanń specjalnych
- Stopień ochrony od przodu: IP65 i IP40
- Wykonania do montażu na drzwiach szafy, na szynie lub w obudowie
- Szeroka gama wykonanń

	Rozdz. - Str.
System kodowania	12 - 2
Formularz wykonanń specjalnych	12 - 3
Rozłączanie i przełączanie	
Rozłączniki. Wykonania tablicowe U... ..	12 - 4
Rozłączniki. Wykonania do montażu na płycie O... ..	12 - 7
Rozłączniki. Wykonania w obudowie P/L... ..	12 - 9
Przełączniki. Wykonania tablicowe U... ..	12 - 10
Przełączniki. Wykonania do montażu na płycie O... ..	12 - 12
Przełączniki. Wykonania w obudowie P/L... ..	12 - 13
Wielopozycyjne	
Początek od 1. Wykonania tablicowe U... ..	12 - 14
Początek od 1. Wykonania do montażu na płycie O... ..	12 - 16
Początek od 1. Wykonania w obudowie P/L... ..	12 - 17
Początek od 0. Wykonania tablicowe U... ..	12 - 18
Początek od 0. Wykonania do montażu na płycie O... ..	12 - 20
Początek od 0. Wykonania w obudowie P/L... ..	12 - 21
Pomiar	
Przełączniki woltomierzy i amperomierzy. Wykonania tablicowe U... ..	12 - 22
Przełączniki woltomierzy i amperomierzy. Wykonania do montażu na płycie O... ..	12 - 24
Rozruch silnika	
Przełączniki: zmiana kierunku pracy silnika, gwiazda-trójkąt, układy Dahlandera, silniki dwubiegowe. Tablicowe U... ..	12 - 26
Przełączniki: zmiana kierunku pracy silnika, gwiazda-trójkąt, układy Dahlandera, silniki dwubiegowe. Na płycie O... ..	12 - 30
Przełączniki: zmiana kierunku pracy silnika, gwiazda-trójkąt, układy Dahlandera, silniki dwubiegowe. W obudowie P/L... ..	12 - 34
Wykonania i wymiary	12 - 36
Akcesoria	12 - 43
Schematy elektryczne	12 - 44
Dane techniczne	12 - 48

**SERIA GF**

- Znamionowy prąd termiczny Ith: 10A i 20A
- Do 24 zestyków
- Otwarcie bezpośrednie zestyków ⊖ według normy IEC/EN/BS 60947-5-1
- Do 12 pozycji przełączania
- Kąty przełączania: 30°, 45°, 60°, 90°
- Możliwość instalacji obok siebie
- Stopień ochrony styków: IP20
- Standardowy stopień ochrony od przodu: IP40

**SERIA 7GN**

- Znamionowy prąd termiczny Ith: 16...125A
- Okrągły korpus styków
- Do 24 zestyków
- Otwarcie bezpośrednie zestyków ⊖ według normy IEC/EN/BS 60947-5-1
- Do 12 pozycji przełączania
- Kąty przełączania: 30°, 45°, 60°, 90°
- Dostępne wykonania w obudowie z tworzywa sztucznego
- Standardowy stopień ochrony od przodu: IP40

**SERIA GX**

- Znamionowy prąd termiczny Ith: 16...40A
- Kwadratowy korpus styków
- Do 24 zestyków
- Otwarcie bezpośrednie zestyków ⊖ według normy IEC/EN/BS 60947-5-1
- Do 12 pozycji przełączania
- Kąty przełączania: 30°, 45°, 60°, 90°
- Dostępne wykonania w obudowie z tworzywa sztucznego
- Możliwość instalacji obok siebie
- Stopień ochrony styków: IP20
- Standardowy stopień ochrony od przodu: IP65

**SERIA GN**

- Znamionowy prąd termiczny Ith: 200...315A
- Dostępne wykonania do 2000A (na zapytanie)
- Do 24 zestyków
- Otwarcie bezpośrednie zestyków ⊖ według normy IEC/EN/BS 60947-5-1
- Do 12 pozycji przełączania
- Kąty przełączania: 30°, 45°, 60°, 90°
- Dostępne wykonania w obudowie z metalu
- Wykonania do 200A i 315A z certyfikatem cURus



Strona 12-42

SERIA GNA20

- Znamionowy prąd termiczny Ith: 20A
- Do 48 zestyków
- Otwarcie bezpośrednie zestyków ⊖ według normy IEC/EN/BS 60947-5-1
- 4 zestyki dla każdej z warstw
- Zredukowana głębokość
- Kąty przełączania: 30°, 45°, 60°, 90°
- Dostępne wykonania w obudowie z tworzywa sztucznego
- Stopień ochrony styków: IP20

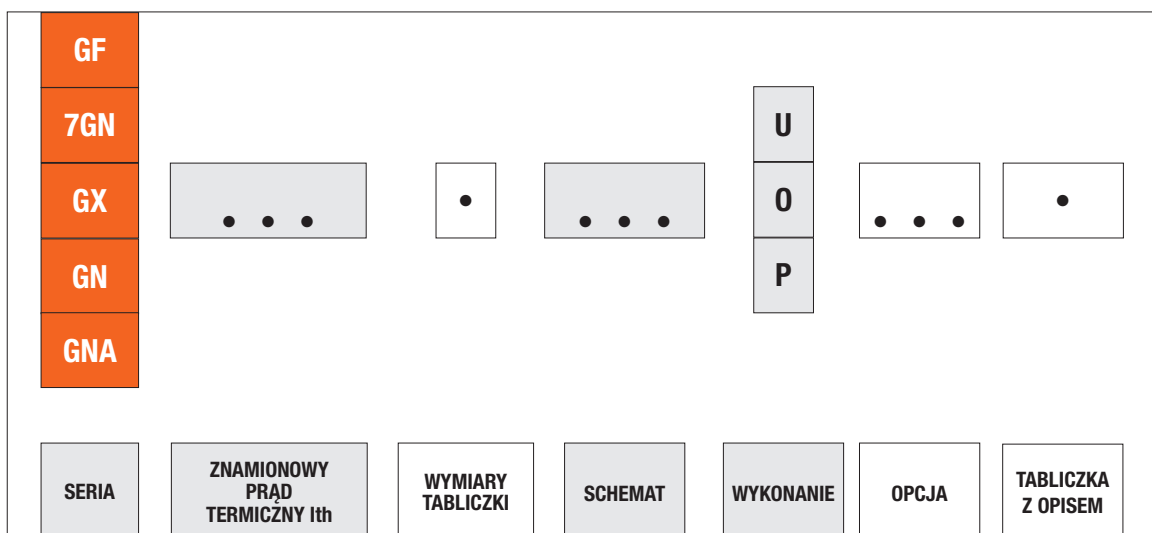

GF
Stopień ochrony:
Od przodu = IP40
Styki = IP20

7GN
Stopień ochrony:
Od przodu = IP40
Styki = IP00

GX
Stopień ochrony:
Od przodu = IP65
Styki = IP20

GN
Stopień ochrony:
Od przodu = IP40
Styki = IP00

GNA
Stopień ochrony:
Od przodu = IP40
Styki = IP20

SERIA	ZNAMIONOWY PRĄD TERMICZNY Ith
GF	10A 16A 20A
7GN	16A 20A 25A 32A 40A 63A 125A
GX	16A 20A 25A 32A 40A
GN	200A 315A
GNA	20A

SCHEMAT	WYKONANIE	OPCJA
90	U = montaż tablicowy	N = dodać N dla wersji z tabliczką przednią z tytułem i czystą etykietą
91	O = montaż na płycie	
10	P = w obudowie z tworzywa	
92	L = w obudowie metalowej (tylko seria GN)	
99		
100		
....		
ⓘ		

Dodać literę H, kiedy tabliczka ma być większa

Tabliczka standardowa	Tabliczka powiększona
30x30mm	48x48mm
48x48mm	65x65mm
65x65mm	90x90mm

Wymiary tabliczek standardowych w różnych wykonaniach dostępne są na stronie 12-36.

Przykład kodu zamówienia:

GX1653P = Przelącznik sieci w obudowie 90x90mm (IP65), trzypolowy 16A, 3 pozycje, 3 segmenty

7GN25H90U51 = Rozłącznik do montażu tablicowego, jednopolowy 25A, 2 pozycje, 1 segment, tabliczka przednia powiększona 65x65mm, stopień ochrony IP65

Więcej informacji można uzyskać w naszym dziale Wsparcia Technicznego (dane na okładce).

25	Montaż tablicowy, pokrętko żółto/czerwone, blokowane kłódką w pozycji 0 i osłony zacisków
65	Montaż tablicowy, pokrętko żółto/czerwone, blokowane kłódką w pozycji 0 i osłony zacisków (tylko dla 7GN)
11	Montaż tablicowy, pokrętko czarne, bez tabliczki, montaż w otworze Ø22mm
12	Montaż tablicowy, sterowanie kluczem, bez tabliczki, montaż w otworze Ø22mm
47	Montaż tablicowy, pokrętko czarne, montaż zatrzaskowy w otworze Ø22mm
48	Montaż na szynie DIN, pokrętko czarne, wersja modułowa
88	Montaż wewnątrz szafy, pokrętko żółto/czerwone, blokowane kłódką w pozycji 0, blokada drzwi i osłony zacisków
98	Montaż wewnątrz szafy, pokrętko żółto/czerwone, blokowane kłódką w pozycji 0, blokada drzwi i osłony zacisków (tylko dla 7GN)
4V	Montaż tablicowy, mocowanie 4 śrubami
51	Montaż tablicowy, pokrętko czarne, stopień ochrony IP65
24	Montaż tablicowy, pokrętko żółto/czerwone, bez blokady kłódką i bez osłon zacisków
29	Montaż tablicowy, tabliczka przednia, sterowanie kluczem, montaż w otworze Ø22mm
29D	Montaż tablicowy, sterowanie kluczem, montaż zatrzaskowy w otworze Ø22mm
06	Montaż tablicowy, pokrętko czarne, blokowane kłódką w pozycji 0
49	Montaż na szynie DIN, sterowanie kluczem, wersja modułowa

ⓘ Na zamówienie dostępne są wykonania specjalne; należy wypełnić formularz na stronie 12-3.

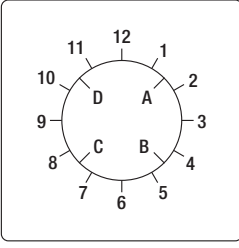
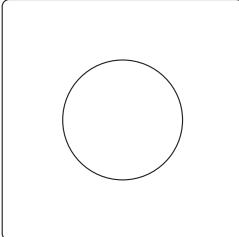

Zapoznaj się z ulotką na naszej stronie www.LovatoElectric.com.
Kod QR z linkiem bezpośrednim obok.

		1	4	5	8	9	12	13	16	17	20	21	24	25	28	29	32	33	36	37	40	41	44	45	48		
		2	3	6	7	10	11	14	15	18	19	22	23	26	27	30	31	34	35	38	39	42	43	46	47		
		2	3	6	7	10	11	14	15	18	19	22	23	26	27	30	31	34	35	38	39	42	43	46	47		
Symbole na tabliczce	poz.																										
	7																										
C	8																										
	9																										
	10																										
D	11																										
	12																										
	1																										
A	2																										
	3																										
	4																										
B	5																										
	6																										
Tabliczka przednia		1	X							X								X									
		2		X						X				X												X	
		Zestyk na zakładkę		Zestyk zamknięty w 2 lub więcej pozycjach				Zestyk otwarty		Zestyk zamknięty			Zestyk z samoczynnym powrotem														
SERIA:		<input type="checkbox"/> GF <input type="checkbox"/> 7GN <input type="checkbox"/> GX <input type="checkbox"/> GN <input type="checkbox"/> GNA										Prąd znamionowy															
WYKONANIE:		<input type="checkbox"/> Montaż tablicowy		<input type="checkbox"/> Montaż na szynie				<input type="checkbox"/> W obudowie		<input type="checkbox"/> Inne																	
POKRĘŁO:		<input type="checkbox"/> Standardowa ❶				<input type="checkbox"/> Pokrętko żółto/czerwone				<input type="checkbox"/> Specjalne																	
MONTAŻ:		<input type="checkbox"/> 2 śruby				<input type="checkbox"/> 4 śruby				<input type="checkbox"/> Zatrzaskowy																	
Ilość:.....		Nazwa firmy:																									
		Osoba kontaktowa:																									
		❶ Standardowo: czarna płytka opisowa, oznaczenie 0-12, czarne pokrętko; każde inne jest uwzględniane, jako specjalne wykonanie. Więcej informacji można uzyskać w naszym dziale Wsparcia Technicznego (dane na okładce).																									

ROZŁĄCZNIKI



Wykonanie do montażu tablicowego z czarnym pokrętkiem (wersja U) ❶

SCHEMATY				❷90	❷91	❷10	❷92	❸05	❸06	❸07	❸08	❸03
Liczba pól				1	2	3	4	1	2	3	4	3
Seria	Wymiary tabliczki [mm]	Prąd termiczny I _{th} [A]	Zastosowanie ogólne UL/CSA [A]									
GF...	□30	10	10	GF1090U	GF1091U	GF1010U	GF1092U	GF1005U	GF1006U	GF1007U	GF1008U	GF1003U
	□48	20	15	GF2090U	GF2091U	GF2010U	GF2092U	GF2005U	GF2006U	GF2007U	GF2008U	GF2003U
7GN...	□48	16	15	7GN1290U	7GN1291U	7GN1210U	7GN1292U	7GN1205U	7GN1206U	7GN1207U	7GN1208U	7GN1203U
		20	20	7GN2090U	7GN2091U	7GN2010U	7GN2092U	7GN2005U	7GN2006U	7GN2007U	7GN2008U	7GN2003U
		25	30	7GN2590U	7GN2591U	7GN2510U	7GN2592U	7GN2505U	7GN2506U	7GN2507U	7GN2508U	7GN2503U
	□65	32	40	7GN3290U	7GN3291U	7GN3210U	7GN3292U	7GN3205U	7GN3206U	7GN3207U	7GN3208U	7GN3203U
		40	50	7GN4090U	7GN4091U	7GN4010U	7GN4092U	7GN4005U	7GN4006U	7GN4007U	7GN4008U	7GN4003U
		63	60	—	—	7GN6310U	7GN6392U	—	—	7GN6307U	7GN6308U	7GN6303U
□90	125	130	—	—	7GN12510U	7GN12592U	—	—	7GN12507U	7GN12508U	7GN12503U	
GX...	□48	16	12	GX1690U	GX1691U	GX1610U	GX1692U	GX1605U	GX1606U	GX1607U	GX1608U	GX1603U
		20	15	GX2090U	GX2091U	GX2010U	GX2092U	GX2005U	GX2006U	GX2007U	GX2008U	GX2003U
	□65	32	32	GX3290U	GX3291U	GX3210U	GX3292U	GX3205U	GX3206U	GX3207U	GX3208U	GX3203U
		40	40	GX4090U	GX4091U	GX4010U	GX4092U	GX4005U	GX4006U	GX4007U	GX4008U	GX4003U
GN...	□132	200	200	—	—	GN20010U	GN20092U	—	—	GN20007U	GN20008U	GN20003U
		315	255	—	—	GN31510U	GN31592U	—	—	GN31507U	GN31508U	GN31503U

Wykonanie do montażu tablicowego z żółto/czerwonym pokrętkiem blokowanym kłódką w pozycji 0 i osłonami zacisków (wersja U25) ❷



SCHEMATY				❷90	❷91	❷10	❷92	❸05	❸06	❸07	❸08
Liczba pól				1	2	3	4	1	2	3	4
Seria	Wymiary tabliczki [mm]	Prąd termiczny I _{th} [A]	Zastosowanie ogólne UL/CSA [A]								
GF...	□48	20	15	GF2090U25	GF2091U25	GF2010U25	GF2092U25	GF2005U25	GF2006U25	GF2007U25	GF2008U25
7GN...	□65	16	15	7GN1290U25	7GN1291U25	7GN1210U25	7GN1292U25	7GN1205U25	7GN1206U25	7GN1207U25	7GN1208U25
		20	20	7GN2090U25	7GN2091U25	7GN2010U25	7GN2092U25	7GN2005U25	7GN2006U25	7GN2007U25	7GN2008U25
		25	30	7GN2590U25	7GN2591U25	7GN2510U25	7GN2592U25	7GN2505U25	7GN2506U25	7GN2507U25	7GN2508U25
		32	40	7GN3290U25	7GN3291U25	7GN3210U25	7GN3292U25	7GN3205U25	7GN3206U25	7GN3207U25	7GN3208U25
		40	50	7GN4090U25	7GN4091U25	7GN4010U25	7GN4092U25	7GN4005U25	7GN4006U25	7GN4007U25	7GN4008U25
GX...	□48	16	12	GX1690U25	GX1691U25	GX1610U25	GX1692U25	GX1605U25	GX1606U25	GX1607U25	GX1608U25
		20	15	GX2090U25	GX2091U25	GX2010U25	GX2092U25	GX2005U25	GX2006U25	GX2007U25	GX2008U25
	□65	32	32	GX3290U25	GX3291U25	GX3210U25	GX3292U25	GX3205U25	GX3206U25	GX3207U25	GX3208U25
		40	40	GX4090U25	GX4091U25	GX4010U25	GX4092U25	GX4005U25	GX4006U25	GX4007U25	GX4008U25

- ❶ Dla wersji z czarnym pokrętkiem blokowanym kłódką w pozycji 0 i bez osłon należy dodać 06 na końcu kodu (np. GF1090U06).
- ❷ Wersja standardowa dostarczana z opisem 0-1. Dla wersji z opisem 0-1 należy dodać C po wartości prądu (np. GF20C90U). Dla wersji z opisem OFF-ON dodać D (np. GF20D90U).
- ❸ Dla wersji z opisem OFF-ON należy dodać C po wartości prądu (np. GF20C05U).
- ❹ Dla wersji z żółto/czerwonym pokrętkiem bez blokady kłódką i bez osłon należy zmienić U25 na U24 (np. GF2090U24).

SCHEMATY

90-91-10-92

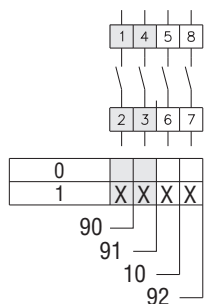

05-06-07-08

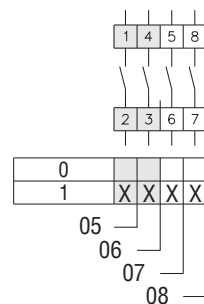

03

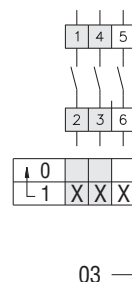

ROZŁĄCZNIKI

Wykonanie do montażu tablicowego z żółto/czerwonym pokrętkiem blokowanym kłódką w pozycji 0 i osłonami zacisków (wersja U65)



SCHEMATY				190	191	110	192	205	206	207	208
Liczba pól				1	2	3	4	1	2	3	4
Seria	Wymiary tabliczki [mm]	Prąd termiczny Ith [A]	Zastosowanie ogólne UL/CSA [A]								
7GN...	□65	16	15	7GN1290U65	7GN1291U65	7GN1210U65	7GN1292U65	7GN1205U65	7GN1206U65	7GN1207U65	7GN1208U65
		20	20	7GN2090U65	7GN2091U65	7GN2010U65	7GN2092U65	7GN2005U65	7GN2006U65	7GN2007U65	7GN2008U65
		25	30	7GN2590U65	7GN2591U65	7GN2510U65	7GN2592U65	7GN2505U65	7GN2506U65	7GN2507U65	7GN2508U65
		32	40	7GN3290U65	7GN3291U65	7GN3210U65	7GN3292U65	7GN3205U65	7GN3206U65	7GN3207U65	7GN3208U65
		40	50	7GN4090U65	7GN4091U65	7GN4010U65	7GN4092U65	7GN4005U65	7GN4006U65	7GN4007U65	7GN4008U65
		63	60	—	—	7GN6310U65	7GN6392U65	—	—	7GN6307U65	7GN6308U65
	□90	125	130	—	—	7GN12510U65	7GN12592U65	—	—	7GN12507U65	7GN12508U65

Wykonanie do montażu tablicowego w otworze Ø22mm z czarnym pokrętkiem bez tabliczki (wersja U11)



SCHEMATY				90	91	10	92	05	06	07	08	03
Liczba pól				1	2	3	4	1	2	3	4	3
Seria	Wymiary tabliczki [mm]	Prąd termiczny Ith [A]	Zastosowanie ogólne UL/CSA [A]									
GF...	—	20	15	GF2090U11	GF2091U11	GF2010U11	GF2092U11	GF2005U11	GF2006U11	GF2007U11	GF2008U11	GF2003U11
7GN...	—	16	15	7GN1290U11	7GN1291U11	7GN1210U11	7GN1292U11	7GN1205U11	7GN1206U11	7GN1207U11	7GN1208U11	7GN1203U11
		20	20	7GN2090U11	7GN2091U11	7GN2010U11	7GN2092U11	7GN2005U11	7GN2006U11	7GN2007U11	7GN2008U11	7GN2003U11
		25	30	7GN2590U11	7GN2591U11	7GN2510U11	7GN2592U11	7GN2505U11	7GN2506U11	7GN2507U11	7GN2508U11	7GN2503U11
GX...	—	16	12	GX1690U11	GX1691U11	GX1610U11	GX1692U11	GX1605U11	GX1606U11	GX1607U11	GX1608U11	GX1603U11
		20	15	GX2090U11	GX2091U11	GX2010U11	GX2092U11	GX2005U11	GX2006U11	GX2007U11	GX2008U11	GX2003U11

- Wersja standardowa dostarczana z opisem 0-1. Dla wersji z opisem 0-1 należy dodać C po wartości prądu (np. 7GN12C90U65). Dla wersji z opisem OFF-ON dodać D (np. 7GN12D90U65).
- Dla wersji z opisem OFF-ON dodać C (np. 7GN12C05U65).

Dane techniczne

Seria	Prąd termiczny Ith [A]	Zastos. ogólne UL/CSA [A]	Moc maksymalna UL/CSA					Moc maks. wg IEC w AC23, 1F [kW] przy 230V	Moc maks. wg IEC w AC23, 3F [kW] przy 400V
			1 fazowy		3 fazowy				
			120V [HP]	240V [HP]	240V [HP]	480V [HP]	600V [HP]		
GF10...	10	10	—	0,75	2	—	—	0,75	3
GF20...	20	15	—	1	3	—	—	2	7,5
7GN12...	16	15	0,5	1	3	—	—	1,7	5,5
7GN20...	20	20	0,75	2	3	7,5	10	2,5	7,5
7GN25...	25	30	1,5	3	5	10	15	3,7	11
7GN32...	32	40	2	5	10	15	15	4	15
7GN40...	40	50	2	5	10	20	20	6	18,5
7GN63...	63	60	3	10	15	25	25	7,5	30
7GN125...	125	130	5	15	25	50	40	11	45

Seria	Prąd termiczny Ith [A]	Zastos. ogólne UL/CSA [A]	Moc maksymalna UL/CSA					Moc maks. wg IEC w AC23, 1F [kW] przy 230V	Moc maks. wg IEC w AC23, 3F [kW] przy 400V
			1 fazowy		3 fazowy				
			120V [HP]	240V [HP]	240V [HP]	480V [HP]	600V [HP]		
GX16...	16	12	0,75	1	3	5	5	1,8	6,5
GX20...	20	15	0,75	1,5	3	5	5	2,2	7,5
GX32...	32	32	1,5	3	7,5	15	15	3,5	15
GX40...	40	40	2	5	10	15	15	5,2	18,5
GN200	200	200	15	30	50	100	75	—	47
GN315	315	255	15	30	50	100	75	37	110

ROZŁĄCZNIKI

Wykonanie do montażu tablicowego w otworze Ø22mm z kluczem bez tabliczki (wersja U12) ❶



SCHEMATY				90	91	10	92	05	06	07	08	03
Liczba pól				1	2	3	4	1	2	3	4	3
Seria	Wymiary tabliczki [mm]	Prąd termiczny I _{th} [A]	Zastosowanie ogólne UL/CSA [A]									
GF...	—	20	15	GF2090U12	GF2091U12	GF2010U12	GF2092U12	GF2005U12	GF2006U12	GF2007U12	GF2008U12	GF2003U12
7GN...	—	16	15	7GN1290U12	7GN1291U12	7GN1210U12	7GN1292U12	7GN1205U12	7GN1206U12	7GN1207U12	7GN1208U12	7GN1203U12
		20	20	7GN2090U12	7GN2091U12	7GN2010U12	7GN2092U12	7GN2005U12	7GN2006U12	7GN2007U12	7GN2008U12	7GN2003U12
		25	30	7GN2590U12	7GN2591U12	7GN2510U12	7GN2592U12	7GN2505U12	7GN2506U12	7GN2507U12	7GN2508U12	7GN2503U12
GX...	—	16	12	GX1690U12	GX1691U12	GX1610U12	GX1692U12	GX1605U12	GX1606U12	GX1607U12	GX1608U12	GX1603U12
		20	15	GX2090U12	GX2091U12	GX2010U12	GX2092U12	GX2005U12	GX2006U12	GX2007U12	GX2008U12	GX2003U12

Wykonanie do montażu tablicowego w otworze Ø22mm z czarnym pokrętkiem montowanym na zatrzask (wersja U47) ❷



SCHEMATY				❷90	❷91	❷10	❷92	❸05	❸06	❸07	❸08	❸03
Liczba pól				1	2	3	4	1	2	3	4	3
Seria	Wymiary tabliczki [mm]	Prąd termiczny I _{th} [A]	Zastosowanie ogólne UL/CSA [A]									
GF...	□30	10	10	GF1090U47	GF1091U47	GF1010U47	GF1092U47	GF1005U47	GF1006U47	GF1007U47	GF1008U47	GF1003U47
	□48	20	15	GF2090U47	GF2091U47	GF2010U47	GF2092U47	GF2005U47	GF2006U47	GF2007U47	GF2008U47	GF2003U47
7GN...	□48	16	15	7GN1290U47	7GN1291U47	7GN1210U47	7GN1292U47	7GN1205U47	7GN1206U47	7GN1207U47	7GN1208U47	7GN1203U47
		20	20	7GN2090U47	7GN2091U47	7GN2010U47	7GN2092U47	7GN2005U47	7GN2006U47	7GN2007U47	7GN2008U47	7GN2003U47
		25	30	7GN2590U47	7GN2591U47	7GN2510U47	7GN2592U47	7GN2505U47	7GN2506U47	7GN2507U47	7GN2508U47	7GN2503U47
GX...	□48	16	12	GX1690U47	GX1691U47	GX1610U47	GX1692U47	GX1605U47	GX1606U47	GX1607U47	GX1608U47	GX1603U47
		20	15	GX2090U47	GX2091U47	GX2010U47	GX2092U47	GX2005U47	GX2006U47	GX2007U47	GX2008U47	GX2003U47

❶ Dla wersji z tabliczką należy zmienić U12 na U29 (np. GF2090U29).

❷ Wersja standardowa dostarczana z opisem 0-1. Dla wersji z opisem 0-I należy dodać C po wartości prądu (np. GF20C90U12). Dla wersji z opisem OFF-ON dodać D (np. GF20D90U12).

❸ Dla wersji z opisem OFF-ON dodać C (np. GF20C05U12).

❹ Dla wersji z kluczem należy zmienić U47 na U29D (np. GF2090U29D).

SCHEMATY

90-91-10-92

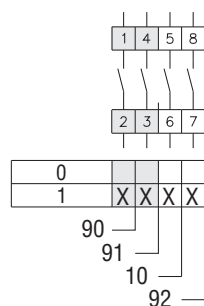

05-06-07-08

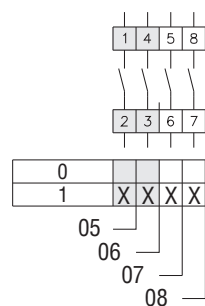

03

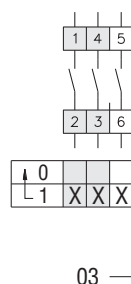

ROZŁĄCZNIKI



Wykonanie do montażu na płycie z czarnym pokrętkiem (wersja 0)

SCHEMATY				190	191	110	192	305	306	307	308	303
Liczba pól				1	2	3	4	1	2	3	4	3
Seria	Wymiary tabliczki [mm]	Prąd termiczny I _{th} [A]	Zastosowanie ogólne UL/CSA [A]									
GF...	48	20	15	GF20900	GF20910	GF20100	GF20920	GF20050	GF20060	GF20070	GF20080	GF20030
7GN...	48	16	15	7GN12900	7GN12910	7GN12100	7GN12920	7GN12050	7GN12060	7GN12070	7GN12080	7GN12030
		20	20	7GN20900	7GN20910	7GN20100	7GN20920	7GN20050	7GN20060	7GN20070	7GN20080	7GN20030
		25	30	7GN25900	7GN25910	7GN25100	7GN25920	7GN25050	7GN25060	7GN25070	7GN25080	7GN25030
	65	32	40	7GN32900	7GN32910	7GN32100	7GN32920	7GN32050	7GN32060	7GN32070	7GN32080	7GN32030
		40	50	7GN40900	7GN40910	7GN40100	7GN40920	7GN40050	7GN40060	7GN40070	7GN40080	7GN40030
90	125	130	—	—	7GN63100	7GN63920	—	—	7GN63070	7GN63080	7GN63030	
GX...	48	16	12	GX16900	GX16910	GX16100	GX16920	GX16050	GX16060	GX16070	GX16080	GX16030
		20	15	GX20900	GX20910	GX20100	GX20920	GX20050	GX20060	GX20070	GX20080	GX20030
	65	32	32	GX32900	GX32910	GX32100	GX32920	GX32050	GX32060	GX32070	GX32080	GX32030
		40	40	GX40900	GX40910	GX40100	GX40920	GX40050	GX40060	GX40070	GX40080	GX40030
132	200	200	—	—	GN200100	GN200920	—	—	GN200070	GN200080	GN200030	
	315	255	—	—	GN315100	GN315920	—	—	GN315070	GN315080	GN315030	

12



Wykonanie modułowe do montażu na szynie DIN z czarnym pokrętkiem (wersja 048) ②

SCHEMATY				190	191	110	192	305	306	307	308
Liczba pól				1	2	3	4	1	2	3	4
Seria	Wymiary tabliczki [mm]	Prąd termiczny I _{th} [A]	Zastosowanie ogólne UL/CSA [A]								
GF...	45x54	20	15	GF2090048	GF2091048	GF2010048	GF2092048	GF2005048	GF2006048	GF2007048	GF2008048
7GN...	45x54	16	15	7GN1290048	7GN1291048	7GN1210048	7GN1292048	7GN1205048	7GN1206048	7GN1207048	7GN1208048
		20	20	7GN2090048	7GN2091048	7GN2010048	7GN2092048	7GN2005048	7GN2006048	7GN2007048	7GN2008048
		25	30	7GN2590048	7GN2591048	7GN2510048	7GN2592048	7GN2505048	7GN2506048	7GN2507048	7GN2508048
GX...	45x54	16	12	GX1690048	GX1691048	GX1610048	GX1692048	GX1605048	GX1606048	GX1607048	GX1608048
		20	15	GX2090048	GX2091048	GX2010048	GX2092048	GX2005048	GX2006048	GX2007048	GX2008048

① Wersja standardowa dostarczana z opisem 0-1. Dla wersji z opisem 0-1 należy dodać C po wartości prądu (np. GF20C900). Dla wersji z opisem OFF-ON dodać D (np. GF20D900).

② Dla wersji z kluczem należy zamienić 048 na 049 (np. GF2090049).

③ Dla wersji z opisem OFF-ON dodać C (np. GF20C050).

Dane techniczne

Seria	Prąd termiczny I _{th} [A]	Zastos. ogólne UL/CSA [A]	Moc maksymalna UL/CSA					Moc maks. wg IEC w AC23, 1F [kW] przy 230V	Moc maks. wg IEC w AC23, 3F [kW] przy 400V
			1 fazowy		3 fazowy				
			120V [HP]	240V [HP]	240V [HP]	480V [HP]	600V [HP]		
GF10...	10	10	—	0,75	2	—	—	0,75	3
GF20...	20	15	—	1	3	—	—	2	7,5
7GN12...	16	15	0,5	1	3	—	—	1,7	5,5
7GN20...	20	20	0,75	2	3	7,5	10	2,5	7,5
7GN25...	25	30	1,5	3	5	10	15	3,7	11
7GN32...	32	40	2	5	10	15	15	4	15
7GN40...	40	50	2	5	10	20	20	6	18,5
7GN63...	63	60	3	10	15	25	25	7,5	30
7GN125...	125	130	5	15	25	50	40	11	45

Seria	Prąd termiczny I _{th} [A]	Zastos. ogólne UL/CSA [A]	Moc maksymalna UL/CSA					Moc maks. wg IEC w AC23, 1F [kW] przy 230V	Moc maks. wg IEC w AC23, 3F [kW] przy 400V
			1 fazowy		3 fazowy				
			120V [HP]	240V [HP]	240V [HP]	480V [HP]	600V [HP]		
GX16...	16	12	0,75	1	3	5	5	1,8	6,5
GX20...	20	15	0,75	1,5	3	5	5	2,2	7,5
GX32...	32	32	1,5	3	7,5	15	15	3,5	15
GX40...	40	40	2	5	10	15	15	5,2	18,5
GN200	200	200	15	30	50	100	75	—	47
GN315	315	255	15	30	50	100	75	37	110

ROZŁĄCZNIKI

Wykonanie do montażu na płycie z żółto/czerwonym pokrętkiem blokowanym w pozycji 0, funkcją blokady drzwi i osłonami zacisków (wersja 088)



SCHEMATY				190	191	110	192	205	206	207	208
Liczba pól				1	2	3	4	1	2	3	4
Seria	Wymiary tabliczki [mm]	Prąd termiczny Ith [A]	Zastosowanie ogólne UL/CSA [A]								
				GF...	7GN...	GX...					
	48	20	15	GF2090088	GF2091088	GF2010088	GF2092088	GF2005088	GF2006088	GF2007088	GF2008088
7GN...	65	16	15	7GN1290088	7GN1291088	7GN1210088	7GN1292088	7GN1205088	7GN1206088	7GN1207088	7GN1208088
		20	20	7GN2090088	7GN2091088	7GN2010088	7GN2092088	7GN2005088	7GN2006088	7GN2007088	7GN2008088
		25	30	7GN2590088	7GN2591088	7GN2510088	7GN2592088	7GN2505088	7GN2506088	7GN2507088	7GN2508088
		32	40	7GN3290088	7GN3291088	7GN3210088	7GN3292088	7GN3205088	7GN3206088	7GN3207088	7GN3208088
		40	50	7GN4090088	7GN4091088	7GN4010088	7GN4092088	7GN4005088	7GN4006088	7GN4007088	7GN4008088
GX...	48	16	12	GX1690088	GX1691088	GX1610088	GX1692088	GX1605088	GX1606088	GX1607088	GX1608088
		20	15	GX2090088	GX2091088	GX2010088	GX2092088	GX2005088	GX2006088	GX2007088	GX2008088
	65	32	32	GX3290088	GX3291088	GX3210088	GX3292088	GX3205088	GX3206088	GX3207088	GX3208088
		40	40	GX4090088	GX4091088	GX4010088	GX4092088	GX4005088	GX4006088	GX4007088	GX4008088

Wykonanie do montażu na płycie z żółto/czerwonym pokrętkiem blokowanym w pozycji 0, funkcją blokady drzwi i osłonami zacisków (wersja 098)



SCHEMATY				190	191	110	192	205	206	207	208
Liczba pól				1	2	3	4	1	2	3	4
Seria	Wymiary tabliczki [mm]	Prąd termiczny Ith [A]	Zastosowanie ogólne UL/CSA [A]								
				7GN...							
	65	16	15	7GN1290098	7GN1291098	7GN1210098	7GN1292098	7GN1205098	7GN1206098	7GN1207098	7GN1208098
7GN...	65	20	20	7GN2090098	7GN2091098	7GN2010098	7GN2092098	7GN2005098	7GN2006098	7GN2007098	7GN2008098
		25	30	7GN2590098	7GN2591098	7GN2510098	7GN2592098	7GN2505098	7GN2506098	7GN2507098	7GN2508098
		32	40	7GN3290098	7GN3291098	7GN3210098	7GN3292098	7GN3205098	7GN3206098	7GN3207098	7GN3208098
		40	50	7GN4090098	7GN4091098	7GN4010098	7GN4092098	7GN4005098	7GN4006098	7GN4007098	7GN4008098
		63	60	—	—	7GN6310098	7GN632098	—	—	7GN6307098	7GN6308098

1 Wersja standardowa dostarczana z opisem 0-1. Dla wersji z opisem 0-1 należy dodać C po wartości prądu (np. GF20C90088). Dla wersji z opisem OFF-ON dodać D (np. GF20D90088).

2 Dla wersji z opisem OFF-ON dodać C (np. GF20C05088).

SCHEMATY

90-91-10-92

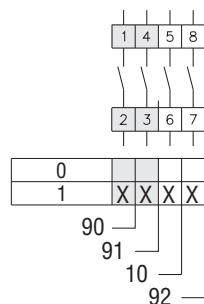

05-06-07-08

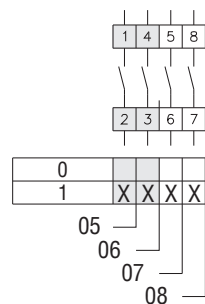

03

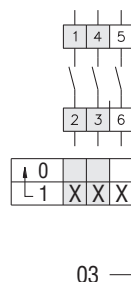

ROZŁĄCZNIKI

Wykonanie w obudowie z tworzywa z czarnym pokrętkiem (wersja P)
 Wykonanie w obudowie z metalu z czarnym pokrętkiem (wersja L)



SCHEMATY				190	191	110	192	205	206	207	208	203
Liczba pól				1	2	3	4	1	2	3	4	3
Seria	Wymiary tabliczki [mm]	Prąd termiczny Ith [A]	Zastosowanie ogólne UL/CSA [A]									
7GN...	75x75	16	15	7GN1290P	7GN1291P	7GN1210P	7GN1292P	7GN1205P	7GN1206P	7GN1207P	7GN1208P	7GN1203P
		20	20	7GN2090P	7GN2091P	7GN2010P	7GN2092P	7GN2005P	7GN2006P	7GN2007P	7GN2008P	7GN2003P
		25	30	7GN2590P	7GN2591P	7GN2510P	7GN2592P	7GN2505P	7GN2506P	7GN2507P	7GN2508P	7GN2503P
	90x90	32	40	7GN3290P	7GN3291P	7GN3210P	7GN3292P	7GN3205P	7GN3206P	7GN3207P	7GN3208P	7GN3203P
		40	50	7GN4090P	7GN4091P	7GN4010P	7GN4092P	7GN4005P	7GN4006P	7GN4007P	7GN4008P	7GN4003P
		125x175	63	60	—	—	7GN6310P	7GN6392P	—	—	7GN6307P	7GN6308P
198x248	125	130	—	—	7GN12510P	7GN12592P	—	—	7GN12507P	7GN12508P	7GN12503P	
GX...	90x90	16	12	GX1690P	GX1691P	GX1610P	GX1692P	GX1605P	GX1606P	GX1607P	GX1608P	GX1603P
		20	15	GX2090P	GX2091P	GX2010P	GX2092P	GX2005P	GX2006P	GX2007P	GX2008P	GX2003P
	110x110	32	32	GX3290P	GX3291P	GX3210P	GX3292P	GX3205P	GX3206P	GX3207P	GX3208P	GX3203P
		40	40	GX4090P	GX4091P	GX4010P	GX4092P	GX4005P	GX4006P	GX4007P	GX4008P	GX4003P
GN...	250x316	200	200	—	—	GN20010L	GN20092L	—	—	GN20007L	GN20008L	GN20003L
		315	255	—	—	GN31510L	GN31592L	—	—	GN31507L	GN31508L	GN31503L

Wykonanie w obudowie z tworzywa z żółto/czerwonym pokrętkiem blokowanym w pozycji 0 (wersja P25)



SCHEMATY				190	191	110	192	205	206	207	208
Liczba pól				1	2	3	4	1	2	3	4
Seria	Wymiary tabliczki [mm]	Prąd termiczny Ith [A]	Zastosowanie ogólne UL/CSA [A]								
7GN...	75x75 lub 90x90	16	15	7GN1290P25	7GN1291P25	7GN1210P25	7GN1292P25	7GN1205P25	7GN1206P25	7GN1207P25	7GN1208P25
		20	20	7GN2090P25	7GN2091P25	7GN2010P25	7GN2092P25	7GN2005P25	7GN2006P25	7GN2007P25	7GN2008P25
		25	30	7GN2590P25	7GN2591P25	7GN2510P25	7GN2592P25	7GN2505P25	7GN2506P25	7GN2507P25	7GN2508P25
	90x90	32	40	7GN3290P25	7GN3291P25	7GN3210P25	7GN3292P25	7GN3205P25	7GN3206P25	7GN3207P25	7GN3208P25
		40	50	7GN4090P25	7GN4091P25	7GN4010P25	7GN4092P25	7GN4005P25	7GN4006P25	7GN4007P25	7GN4008P25
		125x175	63	60	—	—	7GN6310P25	7GN6392P25	—	—	7GN6307P25
198x248	125	130	—	—	7GN12510P25	—	—	—	7GN12507P25	7GN12508P25	
GX...	90x90	16	12	GX1690P25	GX1691P25	GX1610P25	GX1692P25	GX1605P25	GX1606P25	GX1607P25	GX1608P25
		20	15	GX2090P25	GX2091P25	GX2010P25	GX2092P25	GX2005P25	GX2006P25	GX2007P25	GX2008P25
	110x110	32	32	GX3290P25	GX3291P25	GX3210P25	GX3292P25	GX3205P25	GX3206P25	GX3207P25	GX3208P25
		40	40	GX4090P25	GX4091P25	GX4010P25	GX4092P25	GX4005P25	GX4006P25	GX4007P25	GX4008P25

1 Wersja standardowa dostarczana z opisem 0-1. Dla wersji z opisem 0-1 należy dodać C po wartości prądu (np. GF12C90P). Dla wersji z opisem OFF-ON dodać D (np. 7GN12D90P).

2 Dla wersji z opisem OFF-ON dodać C (np. 7GN12C05P).

3 Standardowe wymiary obudowy: 90x90mm. Dostępne są wykonania w obudowie 75x75mm należy dodać B0 na końcu kodu np: 7GN1290P25B0.

Dane techniczne

Seria	Prąd termiczny Ith [A]	Zastos. ogólne UL/CSA [A]	Moc maksymalna UL/CSA					Moc maks. wg IEC w AC23, 1F [kW] przy 230V	Moc maks. wg IEC w AC23, 3F [kW] przy 400V
			1 fazowy		3 fazowy				
			120V [HP]	240V [HP]	240V [HP]	480V [HP]	600V [HP]		
GF20...	20	15	—	1	3	—	2	7,5	
7GN12...	16	15	0,5	1	3	—	1,7	5,5	
7GN20...	20	20	0,75	2	3	7,5	2,5	7,5	
7GN25...	25	30	1,5	3	5	10	3,7	11	
7GN32...	32	40	2	5	10	15	4	15	
7GN40...	40	50	2	5	10	20	6	18,5	
7GN63...	63	60	3	10	15	25	7,5	30	
7GN125...	125	130	5	15	25	50	11	45	

Seria	Prąd termiczny Ith [A]	Zastos. ogólne UL/CSA [A]	Moc maksymalna UL/CSA					Moc maks. wg IEC w AC23, 1F [kW] przy 230V	Moc maks. wg IEC w AC23, 3F [kW] przy 400V
			1 fazowy		3 fazowy				
			120V [HP]	240V [HP]	240V [HP]	480V [HP]	600V [HP]		
GX16...	16	12	0,75	1	3	5	5	1,8	6,5
GX20...	20	15	0,75	1,5	3	5	5	2,2	7,5
GX32...	32	32	1,5	3	7,5	15	15	3,5	15
GX40...	40	40	2	5	10	15	15	5,2	18,5
GN200	200	200	15	30	50	100	75	—	47
GN315	315	255	15	30	50	100	75	37	110

PRZEŁĄCZNIKI

Wykonanie do montażu tablicowego z czarnym pokrętkiem (wersja U)



Typ				Przełączniki z 0				Przełączniki bez 0			
SCHEMATY				51	52	53	75	54	55	56	69
Liczba pól				1	2	3	4	1	2	3	4
Seria	Wymiary tabliczki [mm]	Prąd termiczny I _{th} [A]	Zastosowanie ogólne UL/CSA [A]								
				GF...	<input type="checkbox"/> 30 <input type="checkbox"/> 48	10 20	10 15	GF1051U GF2051U	GF1052U GF2052U	GF1053U GF2053U	GF1075U GF2075U
7GN...	<input type="checkbox"/> 48	16	15	7GN1251U	7GN1252U	7GN1253U	7GN1275U	7GN1254U	7GN1255U	7GN1256U	7GN1269U
		20	20	7GN2051U	7GN2052U	7GN2053U	7GN2075U	7GN2054U	7GN2055U	7GN2056U	7GN2069U
		25	30	7GN2551U	7GN2552U	7GN2553U	7GN2575U	7GN2554U	7GN2555U	7GN2556U	7GN2569U
	<input type="checkbox"/> 65	32	40	7GN3251U	7GN3252U	7GN3253U	7GN3275U	7GN3254U	7GN3255U	7GN3256U	7GN3269U
		40	50	7GN4051U	7GN4052U	7GN4053U	7GN4075U	7GN4054U	7GN4055U	7GN4056U	7GN4069U
<input type="checkbox"/> 90	125	130	—	7GN6352U	7GN6353U	7GN6375U	—	7GN6355U	7GN6356U	7GN6369U	
GX...	<input type="checkbox"/> 48	16	12	GX1651U	GX1652U	GX1653U	GX1675U	GX1654U	GX1655U	GX1656U	GX1669U
		20	15	GX2051U	GX2052U	GX2053U	GX2075U	GX2054U	GX2055U	GX2056U	GX2069U
	<input type="checkbox"/> 65	32	32	GX3251U	GX3252U	GX3253U	GX3275U	GX3254U	GX3255U	GX3256U	GX3269U
GN...	<input type="checkbox"/> 132	200	200	—	GN20052U	GN20053U	GN20075U	—	GN20055U	GN20056U	GN20069U
		315	255	—	GN31552U	GN31553U	GN31575U	—	GN31555U	GN31556U	GN31569U

Wykonanie do montażu tablicowego w otworze Ø22mm z czarnym pokrętkiem bez tabliczki (wersja U11)



Typ				Przełączniki z 0				Przełączniki bez 0			
SCHEMATY				51	52	53	75	54	55	56	69
Liczba pól				1	2	3	4	1	2	3	4
Seria	Wymiary tabliczki [mm]	Prąd termiczny I _{th} [A]	Zastosowanie ogólne UL/CSA [A]								
				GF	—	20	15	GF2051U11	GF2052U11	GF2053U11	GF2075U11
7GN...	—	16	15	7GN1251U11	7GN1252U11	7GN1253U11	7GN1275U11	7GN1254U11	7GN1255U11	7GN1256U11	7GN1269U11
		20	20	7GN2051U11	7GN2052U11	7GN2053U11	7GN2075U11	7GN2054U11	7GN2055U11	7GN2056U11	7GN2069U11
		25	30	7GN2551U11	7GN2552U11	7GN2553U11	7GN2575U11	7GN2554U11	7GN2555U11	7GN2556U11	7GN2569U11
GX...	—	16	12	GX1651U11	GX1652U11	GX1653U11	GX1675U11	GX1654U11	GX1655U11	GX1656U11	GX1669U11
		20	15	GX2051U11	GX2052U11	GX2053U11	GX2075U11	GX2054U11	GX2055U11	GX2056U11	GX2069U11

• Dla wersji z opisem MAN-0-AUTO należy dodać D po wartości prądu (np. GF10D51U).

SCHEMATY

51-52-53-75

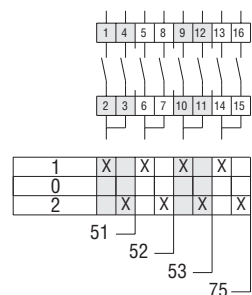

54-55-56-69

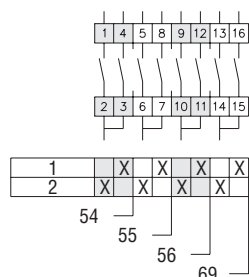

PRZEŁĄCZNIKI

Wykonanie do montażu tablicowego w otworze Ø22mm z kluczem bez tabliczki (wersja U12) ①



Typ				Przełączniki z 0				Przełączniki bez 0			
SCHEMATY				51	52	53	75	54	55	56	69
Liczba pól				1	2	3	4	1	2	3	4
Seria	Wymiary tabliczki [mm]	Prąd termiczny I _{th} [A]	Zastosowanie ogólne UL/CSA [A]								
				GF	—	20	15	GF2051U12	GF2052U12	GF2053U12	GF2075U12
7GN...	—	16	15	7GN1251U12	7GN1252U12	7GN1253U12	7GN1275U12	7GN1254U12	7GN1255U12	7GN1256U12	7GN1269U12
		20	20	7GN2051U12	7GN2052U12	7GN2053U12	7GN2075U12	7GN2054U12	7GN2055U12	7GN2056U12	7GN2069U12
		25	30	7GN2551U12	7GN2552U12	7GN2553U12	7GN2575U12	7GN2554U12	7GN2555U12	7GN2556U12	7GN2569U12
GX...	—	16	12	GX1651U12	GX1652U12	GX1653U12	GX1675U12	GX1654U12	GX1655U12	GX1656U12	GX1669U12
		20	15	GX2051U12	GX2052U12	GX2053U12	GX2075U12	GX2054U12	GX2055U12	GX2056U12	GX2069U12

Wykonanie do montażu tablicowego w otworze Ø22mm z czarnym pokrętkiem montowanym na zatrzask (wersja U47) ②



Typ				Przełączniki z 0				Przełączniki bez 0			
SCHEMATY				51	52	53	75	54	55	56	69
Liczba pól				1	2	3	4	1	2	3	4
Seria	Wymiary tabliczki [mm]	Prąd termiczny I _{th} [A]	Zastosowanie ogólne UL/CSA [A]								
				GF	□30	10	10	GF1051U47	GF1052U47	GF1053U47	GF1075U47
□48	20	15	GF2051U47		GF2052U47	GF2053U47	GF2075U47	GF2054U47	GF2055U47	GF2056U47	GF2069U47
7GN...	□48	16	15	7GN1251U47	7GN1252U47	7GN1253U47	7GN1275U47	7GN1254U47	7GN1255U47	7GN1256U47	7GN1269U47
		20	20	7GN2051U47	7GN2052U47	7GN2053U47	7GN2075U47	7GN2054U47	7GN2055U47	7GN2056U47	7GN2069U47
		25	30	7GN2551U47	7GN2552U47	7GN2553U47	7GN2575U47	7GN2554U47	7GN2555U47	7GN2556U47	7GN2569U47
GX...	□48	16	12	GX1651U47	GX1652U47	GX1653U47	GX1675U47	GX1654U47	GX1655U47	GX1656U47	GX1669U47
		20	15	GX2051U47	GX2052U47	GX2053U47	GX2075U47	GX2054U47	GX2055U47	GX2056U47	GX2069U47

- ① Dla wersji z tabliczką zamienić U12 na U29 (np. GF2051U29).
- ② Dla wersji z opisem MAN-O-AUTO należy dodać D po wartości prądu (np. GF2051U12D).
- ③ Dla wersji z kluczem zamienić U47 na U29D (np. GF2051U29D).

Dane techniczne

Seria	Prąd termiczny I _{th} [A]	Zastos. ogólne UL/CSA [A]	Moc maksymalna UL/CSA					Moc maks. wg IEC w AC23, 1F [kW] przy 230V	Moc maks. wg IEC w AC23, 3F [kW] przy 400V
			1 fazowy		3 fazowy				
			120V [HP]	240V [HP]	240V [HP]	480V [HP]	600V [HP]		
GF10...	10	10	—	0,75	2	—	—	0,75	3
GF20...	20	15	—	1	3	—	—	2	7,5
7GN12...	16	15	0,5	1	3	—	—	1,7	5,5
7GN20...	20	20	0,75	2	3	7,5	10	2,5	7,5
7GN25...	25	30	1,5	3	5	10	15	3,7	11
7GN32...	32	40	2	5	10	15	15	4	15
7GN40...	40	50	2	5	10	20	20	6	18,5
7GN63...	63	60	3	10	15	25	25	7,5	30
7GN125...	125	130	5	15	25	50	40	11	45

Seria	Prąd termiczny I _{th} [A]	Zastos. ogólne UL/CSA [A]	Moc maksymalna UL/CSA					Moc maks. wg IEC w AC23, 1F [kW] przy 230V	Moc maks. wg IEC w AC23, 3F [kW] przy 400V
			1 fazowy		3 fazowy				
			120V [HP]	240V [HP]	240V [HP]	480V [HP]	600V [HP]		
GX16...	16	12	0,75	1	3	5	5	1,8	6,5
GX20...	20	15	0,75	1,5	3	5	5	2,2	7,5
GX32...	32	32	1,5	3	7,5	15	15	3,5	15
GX40...	40	40	2	5	10	15	15	5,2	18,5
GN200	200	200	15	30	50	100	75	—	47
GN315	315	255	15	30	50	100	75	37	110

PRZEŁĄCZNIKI

Wykonanie do montażu na płycie z czarnym pokrętkiem (wersja 0)



Typ				Przełączniki z 0				Przełączniki bez 0			
SCHEMATY				151	152	153	175	54	55	56	69
Liczba pól				1	2	3	4	1	2	3	4
Seria	Wymiary tabliczki [mm]	Prąd termiczny I _{th} [A]	Zastosowanie ogólne UL/CSA [A]								
				GF...	48	20	15	GF20510	GF20520	GF20530	GF20750
7GN...	48	16	15	7GN12510	7GN12520	7GN12530	7GN12750	7GN12540	7GN12550	7GN12560	7GN12690
		20	20	7GN20510	7GN20520	7GN20530	7GN20750	7GN20540	7GN20550	7GN20560	7GN20690
		25	30	7GN25510	7GN25520	7GN25530	7GN25750	7GN25540	7GN25550	7GN25560	7GN25690
	65	32	40	7GN32510	7GN32520	7GN32530	7GN32750	7GN32540	7GN32550	7GN32560	7GN32690
		40	50	7GN40510	7GN40520	7GN40530	7GN40750	7GN40540	7GN40550	7GN40560	7GN40690
90	125	130	—	7GN63520	7GN63530	7GN63750	—	7GN63550	7GN63560	7GN63690	
GX...	48	16	12	GX16510	GX16520	GX16530	GX16750	GX16540	GX16550	GX16560	GX16690
		20	15	GX20510	GX20520	GX20530	GX20750	GX20540	GX20550	GX20560	GX20690
	65	32	32	GX32510	GX32520	GX32530	GX32750	GX32540	GX32550	GX32560	GX32690
GN...	132	200	200	—	GN200520	GN200530	GN200750	—	GN200550	GN200560	GN200690
		315	255	—	GN315520	GN315530	GN315750	—	GN315550	GN315560	GN315690

Wykonanie modułowe do montażu na szynie DIN z czarnym pokrętkiem (wersja 048) Ⓜ



Typ				Przełączniki z 0				Przełączniki bez 0			
SCHEMATY				151	152	153	175	54	55	56	69
Liczba pól				1	2	3	4	1	2	3	4
Seria	Wymiary tabliczki [mm]	Prąd termiczny I _{th} [A]	Zastosowanie ogólne UL/CSA [A]								
				GF	45x54	20	15	GF2051048	GF2052048	GF2053048	GF2075048
7GN...	45x54	16	15	7GN1251048	7GN1252048	7GN1253048	7GN1275048	7GN1254048	7GN1255048	7GN1256048	7GN1269048
		20	20	7GN2051048	7GN2052048	7GN2053048	7GN2075048	7GN2054048	7GN2055048	7GN2056048	7GN2069048
		25	30	7GN2551048	7GN2552048	7GN2553048	7GN2575048	7GN2554048	7GN2555048	7GN2556048	7GN2569048
GX...	45x54	16	12	GX1651048	GX1652048	GX1653048	GX1675048	GX1654048	GX1655048	GX1656048	GX1669048
		20	15	GX2051048	GX2052048	GX2053048	GX2075048	GX2054048	GX2055048	GX2056048	GX2069048

ⓘ Dla wersji z opisem MAN-0-AUTO należy dodać D po wartości prądu (np. GF20D510).

Ⓜ Dla wersji z kluczem zamienić 048 na 049 (np. GF2051049).

SCHEMATY

51-52-53-75

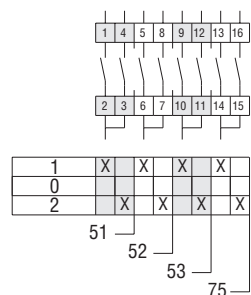

54-55-56-69

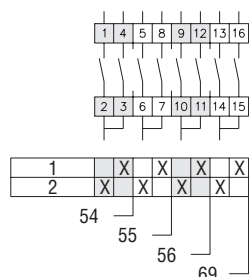

PRZEŁĄCZNIKI

Wykonanie w obudowie z tworzywa z czarnym pokrętkiem (wersja P)

Wykonanie w obudowie z metalu z czarnym pokrętkiem (wersja L)



Typ				Przełączniki z 0				Przełączniki bez 0			
SCHEMATY				151	152	153	175	54	55	56	69
Liczba pól				1	2	3	4	1	2	3	4
Seria	Wymiary tabliczki [mm]	Prąd termiczny I _{th} [A]	Zastosowanie ogólne UL/CSA [A]								
				7GN...	75x75	16	15	7GN1251P	7GN1252P	7GN1253P	7GN1275P
		20	20	7GN2051P	7GN2052P	7GN2053P	7GN2075P	7GN2054P	7GN2055P	7GN2056P	7GN2069P
		25	30	7GN2551P	7GN2552P	7GN2553P	7GN2575P [Ⓜ]	7GN2554P	7GN2555P	7GN2556P	7GN2569P [Ⓜ]
	90x90	32	40	7GN3251P	7GN3252P	7GN3253P	7GN3275P	7GN3254P	7GN3255P	7GN3256P	7GN3269P
	110x110	40	50	7GN4051P	7GN4052P	7GN4053P	7GN4075P	7GN4054P	7GN4055P	7GN4056P	7GN4069P
	125x175	63	60	—	7GN6352P	7GN6353P	7GN6375P	—	7GN6355P	7GN6356P	7GN6369P
	198x248	125	130	—	7GN12552P	7GN12553P	7GN12575P	—	7GN12555P	7GN12556P	7GN12569P
GX...	90x90	16	12	GX1651P	GX1652P	GX1653P	GX1675P	GX1654P	GX1655P	GX1656P	GX1669P
		20	15	GX2051P	GX2052P	GX2053P	GX2075P	GX2054P	GX2055P	GX2056P	GX2069P
	110x110	32	32	GX3251P	GX3252P	GX3253P	GX3275P	GX3254P	GX3255P	GX3256P	GX3269P
		40	40	GX4051P	GX4052P	GX4053P	GX4075P	GX4054P	GX4055P	GX4056P	GX4069P
GN...	250x316	200	200	—	GN20052L	GN20053L	GN20075L	—	GN20055L	GN20056L	GN20069L
		315	255	—	GN31552L	GN31553L	GN31575L	—	GN31555L	GN31556L	GN31569L

Ⓜ Dla wersji z opisem MAN-O-AUTO należy dodać D po wartości prądu (np. 7GN12D51P).

Ⓜ Wymiary obudowy 90x90mm.

Dane techniczne

Seria	Prąd termiczny I _{th} [A]	Zastos. ogólne UL/CSA [A]	Moc maksymalna UL/CSA					Moc maks. wg IEC w AC23, 1F [kW] przy 230V	Moc maks. wg IEC w AC23, 3F [kW] przy 400V
			1 fazowy		3 fazowy				
			120V [HP]	240V [HP]	240V [HP]	480V [HP]	600V [HP]		
GF20...	20	15	—	1	3	—	—	2	7,5
7GN12...	16	15	0,5	1	3	—	—	1,7	5,5
7GN20...	20	20	0,75	2	3	7,5	10	2,5	7,5
7GN25...	25	30	1,5	3	5	10	15	3,7	11
7GN32...	32	40	2	5	10	15	15	4	15
7GN40...	40	50	2	5	10	20	20	6	18,5
7GN63...	63	60	3	10	15	25	25	7,5	30
7GN125...	125	130	5	15	25	50	40	11	45

Seria	Prąd termiczny I _{th} [A]	Zastos. ogólne UL/CSA [A]	Moc maksymalna UL/CSA					Moc maks. wg IEC w AC23, 1F [kW] przy 230V	Moc maks. wg IEC w AC23, 3F [kW] przy 400V
			1 fazowy		3 fazowy				
			120V [HP]	240V [HP]	240V [HP]	480V [HP]	600V [HP]		
GX16...	16	12	0,75	1	3	5	5	1,8	6,5
GX20...	20	15	0,75	1,5	3	5	5	2,2	7,5
GX32...	32	32	1,5	3	7,5	15	15	3,5	15
GX40...	40	40	2	5	10	15	15	5,2	18,5
GN200	200	200	15	30	50	100	75	—	47
GN315	315	255	15	30	50	100	75	37	110

POCZĄTEK OD 1

Wykonanie do montażu tablicowego z czarnym pokrętkiem (wersja U)



SCHEMATY				82	86	93	83	87	94	84	85
Liczba pól				1	2	3	1	2	3	1	1
Seria	Wymiary tabliczki [mm]	Prąd termiczny I _{th} [A]	Zastosowanie ogólne UL/CSA [A]								
				GF...	□30	10	10	GF1082U	GF1086U	GF1093U	GF1083U
	□48	20	15	GF2082U	GF2086U	GF2093U	GF2083U	GF2087U	GF2094U	GF2084U	GF2085U
7GN...	□48	16	15	7GN1282U	7GN1286U	7GN1293U	7GN1283U	7GN1287U	7GN1294U	7GN1284U	7GN1285U
		20	20	7GN2082U	7GN2086U	7GN2093U	7GN2083U	7GN2087U	7GN2094U	7GN2084U	7GN2085U
		25	30	7GN2582U	7GN2586U	7GN2593U	7GN2583U	7GN2587U	7GN2594U	7GN2584U	7GN2585U
	□65	32	40	7GN3282U	7GN3286U	7GN3293U	7GN3283U	7GN3287U	7GN3294U	7GN3284U	7GN3285U
		40	50	7GN4082U	7GN4086U	7GN4093U	7GN4083U	7GN4087U	7GN4094U	7GN4084U	7GN4085U
		63	60	7GN6382U	7GN6386U	7GN6393U	7GN6383U	7GN6387U	7GN6394U	7GN6384U	7GN6385U
□90	125	130	7GN12582U	7GN12586U	7GN12593U	7GN12583U	7GN12587U	7GN12594U	7GN12584U	7GN12585U	
GX...	□48	16	12	GX1682U	GX1686U	GX1693U	GX1683U	GX1687U	GX1694U	GX1684U	GX1685U
		20	15	GX2082U	GX2086U	GX2093U	GX2083U	GX2087U	GX2094U	GX2084U	GX2085U
	□65	32	32	GX3282U	GX3286U	GX3293U	GX3283U	GX3287U	GX3294U	GX3284U	GX3285U
40		40	GX4082U	GX4086U	GX4093U	GX4083U	GX4087U	GX4094U	GX4084U	GX4085U	
GN...	□132	200	200	GN20082U	GN20086U	GN20093U	GN20083U	GN20087U	GN20094U	GN20084U	GN20085U
		315	255	GN31582U	GN31586U	GN31593U	GN31583U	GN31587U	GN31594U	GN31584U	GN31585U

SCHEMATY

82-86-93

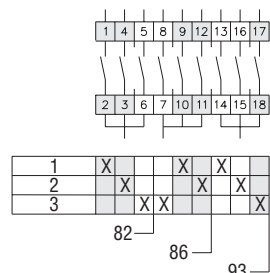

83-87-94

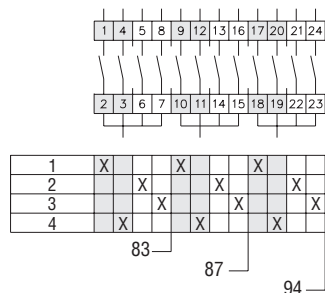

84

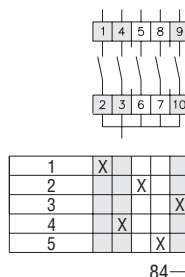

85

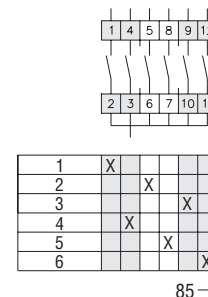

POCZĄTEK OD 1

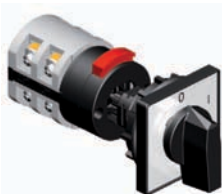

Wykonanie do montażu tablicowego w otworze Ø22mm z czarnym pokrętkiem montowanym na zatrzask (wersja U47) ❶

SCHEMATY				82	86	93	83	87	94	84	85		
Liczba pól				1	2	3	1	2	3	1	1		
Seria	Wymiary tabliczki [mm]	Prąd termiczny I _{th} [A]	Zastosowanie ogólne UL/CSA [A]										
				GF...	□30	10	10	GF1082U47	GF1086U47	GF1093U47	GF1083U47	GF1087U47	GF1094U47
	□48	20	15	GF2082U47	GF2086U47	GF2093U47	GF2083U47	GF2087U47	GF2094U47	GF2084U47	GF2085U47		
7GN...	□48	16	15	7GN1282U47	7GN1286U47	7GN1293U47	7GN1283U47	7GN1287U47	7GN1294U47	7GN1284U47	7GN1285U47		
		20	20	7GN2082U47	7GN2086U47	7GN2093U47	7GN2083U47	7GN2087U47	7GN2094U47	7GN2084U47	7GN2085U47		
		25	30	7GN2582U47	7GN2586U47	7GN2593U47	7GN2583U47	7GN2587U47	7GN2594U47	7GN2584U47	7GN2585U47		
GX...	□48	16	12	GX1682U47	GX1686U47	GX1693U47	GX1683U47	GX1687U47	GX1694U47	GX1684U47	GX1685U47		
		20	15	GX2082U47	GX2086U47	GX2093U47	GX2083U47	GX2087U47	GX2094U47	GX2084U47	GX2085U47		

❶ Dla wersji z kluczem zamienić U47 na U29D (np. GF2082U29D).

Dane techniczne

Seria	Prąd termiczny I _{th} [A]	Zastos. ogólne UL/CSA [A]	Moc maksymalna UL/CSA					Moc maks. wg IEC w AC23, 1F [kW] przy 230V	Moc maks. wg IEC w AC23, 3F [kW] przy 400V
			1 fazowy		3 fazowy				
			120V [HP]	240V [HP]	240V [HP]	480V [HP]	600V [HP]		
GF10...	10	10	—	0,75	2	—	—	0,75	3
GF20...	20	15	—	1	3	—	—	2	7,5
7GN12...	16	15	0,5	1	3	—	—	1,7	5,5
7GN20...	20	20	0,75	2	3	7,5	10	2,5	7,5
7GN25...	25	30	1,5	3	5	10	15	3,7	11
7GN32...	32	40	2	5	10	15	15	4	15
7GN40...	40	50	2	5	10	20	20	6	18,5
7GN63...	63	60	3	10	15	25	25	7,5	30
7GN125...	125	130	5	15	25	50	40	11	45

Seria	Prąd termiczny I _{th} [A]	Zastos. ogólne UL/CSA [A]	Moc maksymalna UL/CSA					Moc maks. wg IEC w AC23, 1F [kW] przy 230V	Moc maks. wg IEC w AC23, 3F [kW] przy 400V
			1 fazowy		3 fazowy				
			120V [HP]	240V [HP]	240V [HP]	480V [HP]	600V [HP]		
GX16...	16	12	0,75	1	3	5	5	1,8	6,5
GX20...	20	15	0,75	1,5	3	5	5	2,2	7,5
GX32...	32	32	1,5	3	7,5	15	15	3,5	15
GX40...	40	40	2	5	10	15	15	5,2	18,5
GN200	200	200	15	30	50	100	75	—	47
GN315	315	255	15	30	50	100	75	37	110

POCZĄTEK OD 1

Wykonanie do montażu na płycie z czarnym pokrętkiem (wersja 0)



SCHEMATY				82	86	93	83	87	94	84	85
Liczba pól				1	2	3	1	2	3	1	1
Seria	Wymiary tabliczki [mm]	Prąd termiczny I _{th} [A]	Zastosowanie ogólne UL/CSA [A]								
GF...	<input type="checkbox"/> 48	20	15	GF20820	GF20860	GF20930	GF20830	GF20870	GF20940	GF20840	GF20850
7GN...	<input type="checkbox"/> 48	16	15	7GN12820	7GN12860	7GN12930	7GN12830	7GN12870	7GN12940	7GN12840	7GN12850
		20	20	7GN20820	7GN20860	7GN20930	7GN20830	7GN20870	7GN20940	7GN20840	7GN20850
		25	30	7GN25820	7GN25860	7GN25930	7GN25830	7GN25870	7GN25940	7GN25840	7GN25850
	<input type="checkbox"/> 65	32	40	7GN32820	7GN32860	7GN32930	7GN32830	7GN32870	7GN32940	7GN32840	7GN32850
		40	50	7GN40820	7GN40860	7GN40930	7GN40830	7GN40870	7GN40940	7GN40840	7GN40850
<input type="checkbox"/> 90	125	130	7GN125820	7GN125860	7GN125930	7GN125830	7GN125870	7GN125940	7GN125840	7GN125850	
GX...	<input type="checkbox"/> 48	16	12	GX16820	GX16860	GX16930	GX16830	GX16870	GX16940	GX16840	GX16850
		20	15	GX20820	GX20860	GX20930	GX20830	GX20870	GX20940	GX20840	GX20850
	<input type="checkbox"/> 65	32	32	GX32820	GX32860	GX32930	GX32830	GX32870	GX32940	GX32840	GX32850
		40	40	GX40820	GX40860	GX40930	GX40830	GX40870	GX40940	GX40840	GX40850
GN...	<input type="checkbox"/> 132	200	200	GN200820	GN200860	GN200930	GN200830	GN200870	GN200940	GN200840	GN200850
		315	255	GN315820	GN315860	GN315930	GN315830	GN315870	GN315940	GN315840	GN315850

Wykonanie modułowe do montażu na szynie DIN z czarnym pokrętkiem (wersja 048) ❶



SCHEMATY				82	86	93	83	87	94	84	85
Liczba pól				1	2	3	1	2	3	1	1
Seria	Wymiary tabliczki [mm]	Prąd termiczny I _{th} [A]	Zastosowanie ogólne UL/CSA [A]								
GF...	45x54	20	15	GF2082048	GF2086048	GF2093048	GF2083048	GF2087048	GF2094048	GF2084048	GF2085048
7GN...	45x54	16	15	7GN1282048	7GN1286048	7GN1293048	7GN1283048	7GN1287048	7GN1294048	7GN1284048	7GN1285048
		20	20	7GN2082048	7GN2086048	7GN2093048	7GN2083048	7GN2087048	7GN2094048	7GN2084048	7GN2085048
		25	30	7GN2582048	7GN2586048	7GN2593048	7GN2583048	7GN2587048	7GN2594048	7GN2584048	7GN2585048
GX...	45x54	16	12	GX1682048	GX1686048	GX1693048	GX1683048	GX1687048	GX1694048	GX1684048	GX1685048
		20	15	GX2082048	GX2086048	GX2093048	GX2083048	GX2087048	GX2094048	GX2084048	GX2085048

❶ Dla wersji z kluczem zamienić 048 na 049 (np. GF2082049).

SCHEMATY

82-86-93

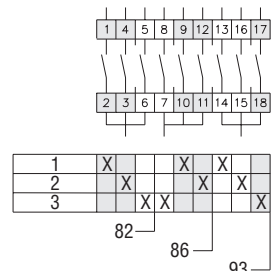

83-87-94

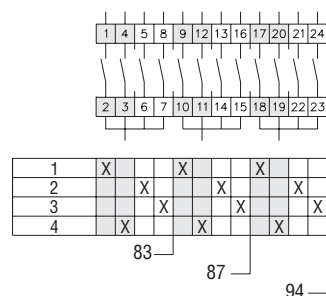

84

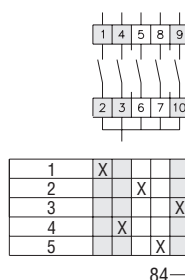

85

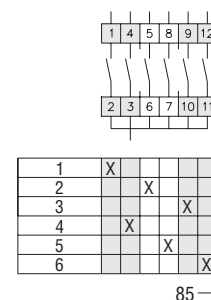

POCZĄTEK OD 1

Wykonanie w obudowie z tworzywa z czarnym pokrętkiem (wersja P)
 Wykonanie w obudowie z metalu z czarnym pokrętkiem (wersja L)



SCHEMATY				82	86	93	83	87	94	84	85	
Liczba pól				1	2	3	1	2	3	1	1	
Seria	Wymiary tabliczki [mm]	Prąd termiczny I _{th} [A]	Zastosowanie ogólne UL/CSA [A]									
				7GN1282P	7GN1286P	7GN1293P ¹	7GN1283P	7GN1287P	7GN1294P ¹	7GN1284P	7GN1285P	
7GN...	75x75	16	15	7GN2082P	7GN2086P	7GN2093P ¹	7GN2083P	7GN2087P	7GN2094P ¹	7GN2084P	7GN2085P	
		20	20	7GN2582P	7GN2586P	7GN2593P ²	7GN2583P	7GN2587P ¹	—	7GN2584P	7GN2585P ¹	
		25	30	7GN3282P	7GN3286P	7GN3293P	7GN3283P	7GN3287P	7GN3294P ¹	7GN3284P	7GN3285P	
	90x90	32	40	7GN4082P	7GN4086P	7GN4093P	7GN4083P	7GN4087P	7GN4094P ³	7GN4084P	7GN4085P	
		40	50	7GN6382P	7GN6386P	7GN6393P ³	7GN6383P	7GN6387P	7GN6394P ³	7GN6384P	7GN6385P	
		63	60	7GN12582P	7GN12586P	—	7GN12583P	7GN12587P	—	7GN12584P	—	
98x248	125	130	GX1682P	GX1686P	GX1693P	GX1683P	GX1687P	GX1694P ²	GX1684P	GX1685P		
	90x90	16	12	GX2082P	GX2086P	GX2093P	GX2083P	GX2087P	GX2094P ²	GX2084P	GX2085P	
		20	15	GX3282P	GX3286P	—	GX3283P	GX3287P	—	GX3284P	—	
		32	32	GX4082P	GX4086P	—	GX4083P	GX4087P	—	GX4084P	—	
110x110	40	40	GN20082L	GN20086L	GN20093L	GN20083L	GN20087L	GN20094L	GN20084L	GN20085L		
	40	40	GN31582L	GN31586L	GN31593L	GN31583L	GN31587L	GN31594L	GN31584L	GN31585L		

- ¹ Wymiary obudowy 90x90mm.
- ² Wymiary obudowy 110x110mm.
- ³ Wymiary obudowy 198x248mm.

Dane techniczne

Seria	Prąd termiczny I _{th} [A]	Zastos. ogólne UL/CSA [A]	Moc maksymalna UL/CSA					Moc maks. wg IEC w AC23, 1F [kW] przy 230V	Moc maks. wg IEC w AC23, 3F [kW] przy 400V
			1 fazowy		3 fazowy				
			120V [HP]	240V [HP]	240V [HP]	480V [HP]	600V [HP]		
GF20...	20	15	—	1	3	—	—	2	7,5
7GN12...	16	15	0,5	1	3	—	—	1,7	5,5
7GN20...	20	20	0,75	2	3	7,5	10	2,5	7,5
7GN25...	25	30	1,5	3	5	10	15	3,7	11
7GN32...	32	40	2	5	10	15	15	4	15
7GN40...	40	50	2	5	10	20	20	6	18,5
7GN63...	63	60	3	10	15	25	25	7,5	30
7GN125...	125	130	5	15	25	50	40	11	45

Seria	Prąd termiczny I _{th} [A]	Zastos. ogólne UL/CSA [A]	Moc maksymalna UL/CSA					Moc maks. wg IEC w AC23, 1F [kW] przy 230V	Moc maks. wg IEC w AC23, 3F [kW] przy 400V
			1 fazowy		3 fazowy				
			120V [HP]	240V [HP]	240V [HP]	480V [HP]	600V [HP]		
GX16...	16	12	0,75	1	3	5	5	1,8	6,5
GX20...	20	15	0,75	1,5	3	5	5	2,2	7,5
GX32...	32	32	1,5	3	7,5	15	15	3,5	15
GX40...	40	40	2	5	10	15	15	5,2	18,5
GN200	200	200	15	30	50	100	75	—	47
GN315	315	255	15	30	50	100	75	37	110

POCZĄTEK OD 0

Wykonanie do montażu tablicowego z czarnym pokrętkiem (wersja U)



SCHEMATY				107	123	135	108	124	136	109	110
Liczba pól				1	2	3	1	2	3	1	1
Seria	Wymiary tabliczki [mm]	Prąd termiczny I _{th} [A]	Zastosowanie ogólne UL/CSA [A]								
GF...	□30	10	10	GF10107U	GF10123U	GF10135U	GF10108U	GF10124U	GF10136U	GF10109U	GF10110U
	□48	20	15	GF20107U	GF20123U	GF20135U	GF20108U	GF20124U	GF20136U	GF20109U	GF20110U
7GN...	□48	16	15	7GN12107U	7GN12123U	7GN12135U	7GN12108U	7GN12124U	7GN12136U	7GN12109U	7GN12110U
		20	20	7GN20107U	7GN20123U	7GN20135U	7GN20108U	7GN20124U	7GN20136U	7GN20109U	7GN20110U
		25	30	7GN25107U	7GN25123U	7GN25135U	7GN25108U	7GN25124U	7GN25136U	7GN25109U	7GN25110U
	□65	32	40	7GN32107U	7GN32123U	7GN32135U	7GN32108U	7GN32124U	7GN32136U	7GN32109U	7GN32110U
		40	50	7GN40107U	7GN40123U	7GN40135U	7GN40108U	7GN40124U	7GN40136U	7GN40109U	7GN40110U
63	60	7GN63107U	7GN63123U	7GN63135U	7GN63108U	7GN63124U	7GN63136U	7GN63109U	7GN63110U		
GX...	□48	16	12	GX16107U	GX16123U	GX16135U	GX16108U	GX16124U	GX16136U	GX16109U	GX16110U
		20	15	GX20107U	GX20123U	GX20135U	GX20108U	GX20124U	GX20136U	GX20109U	GX20110U
	□65	32	32	GX32107U	GX32123U	GX32135U	GX32108U	GX32124U	GX32136U	GX32109U	GX32110U
40	40	GX40107U	GX40123U	GX40135U	GX40108U	GX40124U	GX40136U	GX40109U	GX40110U		
GN...	□132	200	200	GN200107U	GN200123U	GN200135U	GN200108U	GN200124U	GN200136U	GN200109U	GN200110U
		315	255	GN315107U	GN315123U	GN315135U	GN315108U	GN315124U	GN315136U	GN315109U	GN315110U

① Tabliczka do GF..., 7GN12...7GN63..., GX..., GN...

② Tabliczka do 7GN125...

SCHEMATY

107-123-135

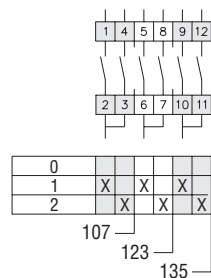

108-124-136

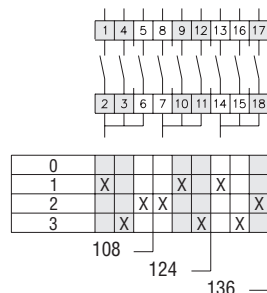

109

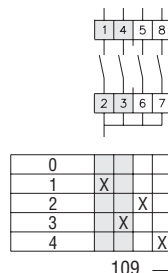

110

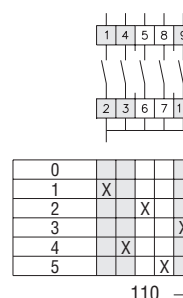

POCZĄTEK OD 0



Wykonanie do montażu tablicowego w otworze Ø22mm z czarnym pokrętkiem montowanym na zatrzask (wersja U47) ❶

SCHEMATY				107	123	135	108	124	136	109	110	
Liczba pól				1	2	3	1	2	3	1	1	
Seria	Wymiary tabliczki [mm]	Prąd termiczny I _{th} [A]	Zastosowanie ogólne UL/CSA [A]									
GF...	□30	10	10	GF10107U47	GF10123U47	GF10135U47	GF10108U47	GF10124U47	GF10136U47	GF10109U47	GF10110U47	
	□48	20	15	GF20107U47	GF20123U47	GF20135U47	GF20108U47	GF20124U47	GF20136U47	GF20109U47	GF20110U47	
7GN...	□48	16	15	7GN12107U47	7GN12123U47	7GN12135U47	7GN12108U47	7GN12124U47	7GN12136U47	7GN12109U47	7GN12110U47	
		20	20	7GN20107U47	7GN20123U47	7GN20135U47	7GN20108U47	7GN20124U47	7GN20136U47	7GN20109U47	7GN20110U47	
		25	30	7GN25107U47	7GN25123U47	7GN25135U47	7GN25108U47	7GN25124U47	7GN25136U47	7GN25109U47	7GN25110U47	
GX...	□48	16	12	GX16107U47	GX16123U47	GX16135U47	GX16108U47	GX16124U47	GX16136U47	GX16109U47	GX16110U47	
		20	15	GX20107U47	GX20123U47	GX20135U47	GX20108U47	GX20124U47	GX20136U47	GX20109U47	GX20110U47	

❶ Dla wersji z kluczem zamienić U47 na U29D (np. GF20107U29D).

Dane techniczne

Seria	Prąd termiczny I _{th} [A]	Zastos. ogólne UL/CSA [A]	Moc maksymalna UL/CSA					Moc maks. wg IEC w AC23, 1F [kW] przy 230V	Moc maks. wg IEC w AC23, 3F [kW] przy 400V
			1 fazowy		3 fazowy				
			120V [HP]	240V [HP]	240V [HP]	480V [HP]	600V [HP]		
GF10...	10	10	—	0,75	2	—	—	0,75	3
GF20...	20	15	—	1	3	—	—	2	7,5
7GN12...	16	15	0,5	1	3	—	—	1,7	5,5
7GN20...	20	20	0,75	2	3	7,5	10	2,5	7,5
7GN25...	25	30	1,5	3	5	10	15	3,7	11
7GN32...	32	40	2	5	10	15	15	4	15
7GN40...	40	50	2	5	10	20	20	6	18,5
7GN63...	63	60	3	10	15	25	25	7,5	30
7GN125...	125	130	5	15	25	50	40	11	45

Seria	Prąd termiczny I _{th} [A]	Zastos. ogólne UL/CSA [A]	Moc maksymalna UL/CSA					Moc maks. wg IEC w AC23, 1F [kW] przy 230V	Moc maks. wg IEC w AC23, 3F [kW] przy 400V
			1 fazowy		3 fazowy				
			120V [HP]	240V [HP]	240V [HP]	480V [HP]	600V [HP]		
GX16...	16	12	0,75	1	3	5	5	1,8	6,5
GX20...	20	15	0,75	1,5	3	5	5	2,2	7,5
GX32...	32	32	1,5	3	7,5	15	15	3,5	15
GX40...	40	40	2	5	10	15	15	5,2	18,5
GN200	200	200	15	30	50	100	75	—	47
GN315	315	255	15	30	50	100	75	37	110

POCZĄTEK OD 0



Wykonanie do montażu na płycie z czarnym pokrętkiem (wersja 0)

SCHEMATY				107	123	135	108	124	136	109	110
Liczba pól				1	2	3	1	2	3	1	1
Seria	Wymiary tabliczki	Prąd termiczny I _{th}	Zastosowanie ogólne UL/CSA								
	[mm]	[A]	[A]								
GF...	<input type="checkbox"/> 48	20	15	GF201070	GF201230	GF201350	GF201080	GF201240	GF201360	GF201090	GF201100
7GN...	<input type="checkbox"/> 48	16	15	7GN121070	7GN121230	7GN121350	7GN121080	7GN121240	7GN121360	7GN121090	7GN121100
		20	20	7GN201070	7GN201230	7GN201350	7GN201080	7GN201240	7GN201360	7GN201090	7GN201100
		25	30	7GN251070	7GN251230	7GN251350	7GN251080	7GN251240	7GN251360	7GN251090	7GN251100
	<input type="checkbox"/> 65	32	40	7GN321070	7GN321230	7GN321350	7GN321080	7GN321240	7GN321360	7GN321090	7GN321100
		40	50	7GN401070	7GN401230	7GN401350	7GN401080	7GN401240	7GN401360	7GN401090	7GN401100
	63	60	7GN631070	7GN631230	7GN631350	7GN631080	7GN631240	7GN631360	7GN631090	7GN631100	
GX...	<input type="checkbox"/> 48	16	12	GX161070	GX161230	GX161350	GX161080	GX161240	GX161360	GX161090	GX161100
		20	15	GX201070	GX201230	GX201350	GX201080	GX201240	GX201360	GX201090	GX201100
	<input type="checkbox"/> 65	32	32	GX321070	GX321230	GX321350	GX321080	GX321240	GX321360	GX321090	GX321100
	40	40	GX401070	GX401230	GX401350	GX401080	GX401240	GX401360	GX401090	GX401100	
GN...	<input type="checkbox"/> 132	200	200	GN2001070	GN2001230	GN2001350	GN2001080	GN2001240	GN2001360	GN2001090	GN2001100
		315	255	GN3151070	GN3151230	GN3151350	GN3151080	GN3151240	GN3151360	GN3151090	GN3151100



Wykonanie modułowe do montażu na szynie DIN z czarnym pokrętkiem (wersja 048) Ⓢ

SCHEMATY				107	123	135	108	124	136	109	110
Liczba pól				1	2	3	1	2	3	1	1
Seria	Wymiary tabliczki	Prąd termiczny I _{th}	Zastosowanie ogólne UL/CSA								
	[mm]	[A]	[A]								
GF...	45x54	20	15	GF20107048	GF20123048	GF20135048	GF20108048	GF20124048	GF20136048	GF20109048	GF20110048
7GN...	45x54	16	15	7GN12107048	7GN12123048	7GN12135048	7GN12108048	7GN12124048	7GN12136048	7GN12109048	7GN12110048
		20	20	7GN20107048	7GN20123048	7GN20135048	7GN20108048	7GN20124048	7GN20136048	7GN20109048	7GN20110048
		25	30	7GN25107048	7GN25123048	7GN25135048	7GN25108048	7GN25124048	7GN25136048	7GN25109048	7GN25110048
GX...	45x54	16	12	GX16107048	GX16123048	GX16135048	GX16108048	GX16124048	GX16136048	GX16109048	GX16110048
		20	15	GX20107048	GX20123048	GX20135048	GX20108048	GX20124048	GX20136048	GX20109048	GX20110048

Ⓢ Tabliczka do GF..., 7GN12..., 7GN63..., GX..., GN...

Ⓢ Tabliczka do 7GN125...

Ⓢ Dla wersji z kluczem należy zamienić 048 na 049 (np. GF20107049).

SCHEMATY

107-123-135

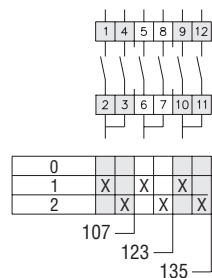

108-124-136

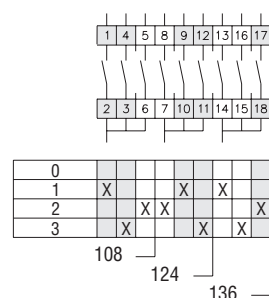

109

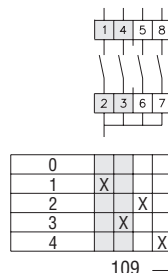

110

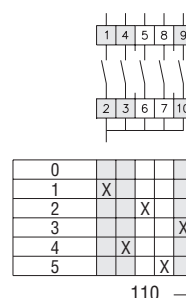

POCZĄTEK OD 0

Wykonanie w obudowie z tworzywa z czarnym pokrętkiem (wersja P)
Wykonanie w obudowie z metalu z czarnym pokrętkiem (wersja L)



SCHEMATY				107	123	135	108	124	136	109	110
Liczba pól				1	2	3	1	2	3	1	1
Seria	Wymiary tabliczki	Prąd termiczny I _{th}	Zastosowanie ogólne UL/CSA								
				[mm]	[A]	[A]					
7GN...	75x75	16	15	7GN12107P	7GN12123P	7GN12135P	7GN12108P	7GN12124P	7GN12136P [ⓐ]	7GN12109P	7GN12110P
		20	20	7GN20107P	7GN20123P	7GN20135P	7GN20108P	7GN20124P	7GN20136P [ⓐ]	7GN20109P	7GN20110P
		25	30	7GN25107P	7GN25123P	7GN25135P	7GN25108P	7GN25124P	7GN25136P [ⓐ]	7GN25109P	7GN25110P
	90x90	32	40	7GN32107P	7GN32123P	7GN32135P	7GN32108P	7GN32124P	7GN32136P	7GN32109P	7GN32110P
		110x110	40	50	7GN40107P	7GN40123P	7GN40135P	7GN40108P	7GN40124P	7GN40136P	7GN40109P
125x175	63	60	7GN63107P	7GN63123P	7GN63135P	7GN63108P	7GN63124P	7GN63136P [ⓐ]	7GN63109P	7GN63110P	
	198x248	125	130	7GN125107P	7GN125123P	7GN125135P	7GN125108P	7GN125124P	—	7GN125109P	7GN125110P
GX...	90x90	16	12	GX16107P	GX16123P	GX16135P	GX16108P	GX16124P	GX16136P	GX16109P	GX16110P
		20	15	GX20107P	GX20123P	GX20135P	GX20108P	GX20124P	GX20136P	GX20109P	GX20110P
	110x110	32	32	GX32107P	GX32123P	GX32135P	GX32108P	GX32124P	—	GX32109P	GX32110P
40		40	GX40107P	GX40123P	GX40135P	GX40108P	GX40124P	—	GX40109P	GX40110P	
GN...	250x316	200	200	GN200107L	GN200123L	GN200135L	GN200108L	GN200124L	GN200136L	GN200109L	GN200110L
		315	255	GN315107L	GN315123L	GN315135L	GN315108L	GN315124L	GN315136L	GN315109L	GN315110L

- ⓐ Tabliczka do GF..., 7GN12..., 7GN63..., GX..., GN...
- ⓑ Tabliczka do 7GN125...
- ⓒ Wymiary obudowy 90x90mm.
- ⓓ Wymiary obudowy 110x110mm.
- ⓔ Wymiary obudowy 198x248mm.

Dane techniczne

Seria	Prąd termiczny I _{th}	Zastos. ogólne UL/CSA	Moc maksymalna UL/CSA					Moc maks. wg IEC w AC23, 1F [kW] przy 230V	Moc maks. wg IEC w AC23, 3F [kW] przy 400V
			1 fazowy		3 fazowy				
			120V [HP]	240V [HP]	240V [HP]	480V [HP]	600V [HP]		
GF20...	20	15	—	1	3	—	—	2	7,5
7GN12...	16	15	0,5	1	3	—	—	1,7	5,5
7GN20...	20	20	0,75	2	3	7,5	10	2,5	7,5
7GN25...	25	30	1,5	3	5	10	15	3,7	11
7GN32...	32	40	2	5	10	15	15	4	15
7GN40...	40	50	2	5	10	20	20	6	18,5
7GN63...	63	60	3	10	15	25	25	7,5	30
7GN125...	125	130	5	15	25	50	40	11	45

Seria	Prąd termiczny I _{th}	Zastos. ogólne UL/CSA	Moc maksymalna UL/CSA					Moc maks. wg IEC w AC23, 1F [kW] przy 230V	Moc maks. wg IEC w AC23, 3F [kW] przy 400V
			1 fazowy		3 fazowy				
			120V [HP]	240V [HP]	240V [HP]	480V [HP]	600V [HP]		
GX16...	16	12	0,75	1	3	5	5	1,8	6,5
GX20...	20	15	0,75	1,5	3	5	5	2,2	7,5
GX32...	32	32	1,5	3	7,5	15	15	3,5	15
GX40...	40	40	2	5	10	15	15	5,2	18,5
GN200	200	200	15	30	50	100	75	—	47
GN315	315	255	15	30	50	100	75	37	110

PRZELĄCZNIKI WOLTOMIERZY I AMPEROMIERZY

Wykonanie do montażu tablicowego z czarnym pokrętkiem (wersja U)



Typ				Przelączniki woltomierzy			Przelączniki amperomierzy	
SCHEMATY				66	67	68	97	98
Seria	Wymiary tabliczki [mm]	Prąd termiczny I _{th} [A]	Zastosowanie ogólne UL/CSA [A]					
GF...	□30	10	10	GF1066U	GF1067U	GF1068U	GF1097U	GF1098U
	□48	20	15	GF2066U	GF2067U	GF2068U	GF2097U	GF2098U
7GN...	□48	16	15	7GN1266U	7GN1267U	7GN1268U	7GN1297U	7GN1298U
		20	20	7GN2066U	7GN2067U	7GN2068U	7GN2097U	7GN2098U
		25	30	7GN2566U	7GN2567U	7GN2568U	7GN2597U	7GN2598U
	□65	32	40	7GN3266U	7GN3267U	7GN3268U	7GN3297U	7GN3298U
		40	50	7GN4066U	7GN4067U	7GN4068U	7GN4097U	7GN4098U
GX...	□48	16	12	GX1666U	GX1667U	GX1668U	GX1697U	GX1698U
		20	15	GX2066U	GX2067U	GX2068U	GX2097U	GX2098U
	□65	32	32	GX3266U	GX3267U	GX3268U	GX3297U	GX3298U
		40	40	GX4066U	GX4067U	GX4068U	GX4097U	GX4098U

Wykonanie do montażu tablicowego w otworze Ø22mm z czarnym pokrętkiem montowanym na zatrzask (wersja U47) Ⓢ

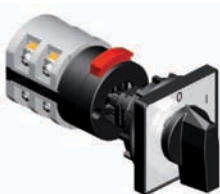

Typ				Przelączniki woltomierzy			Przelączniki amperomierzy	
SCHEMATY				66	67	68	97	98
Seria	Wymiary tabliczki [mm]	Prąd termiczny I _{th} [A]	Zastosowanie ogólne UL/CSA [A]					
GF...	□30	10	10	GF1066U47	GF1067U47	GF1068U47	GF1097U47	GF1098U47
	□48	20	15	GF2066U47	GF2067U47	GF2068U47	GF2097U47	GF2098U47
7GN...	□48	16	15	7GN1266U47	7GN1267U47	7GN1268U47	7GN1297U47	7GN1298U47
		20	20	7GN2066U47	7GN2067U47	7GN2068U47	7GN2097U47	7GN2098U47
		25	30	7GN2566U47	7GN2567U47	7GN2568U47	7GN2597U47	7GN2598U47
GX...	□48	16	12	GX1666U47	GX1667U47	GX1668U47	GX1697U47	GX1698U47
		20	15	GX2066U47	GX2067U47	GX2068U47	GX2097U47	GX2098U47

Ⓛ Tabliczka do GF20..., 7GN..., GX..., GN...

Ⓧ Tabliczka do GF10...

Ⓢ Dla wersji z kluczem zamienić U47 na U29D (np. GF2066U29D).

SCHEMATY

66

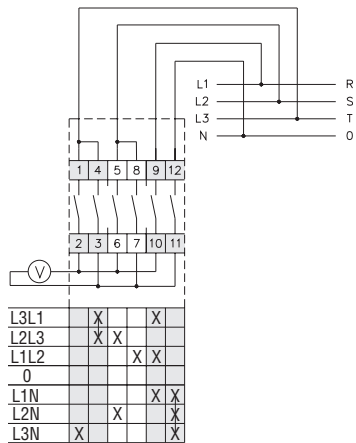

67

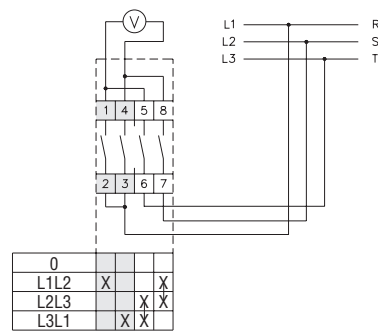

68

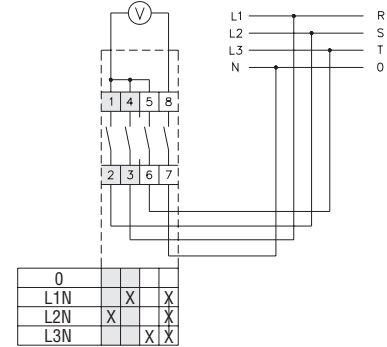

97

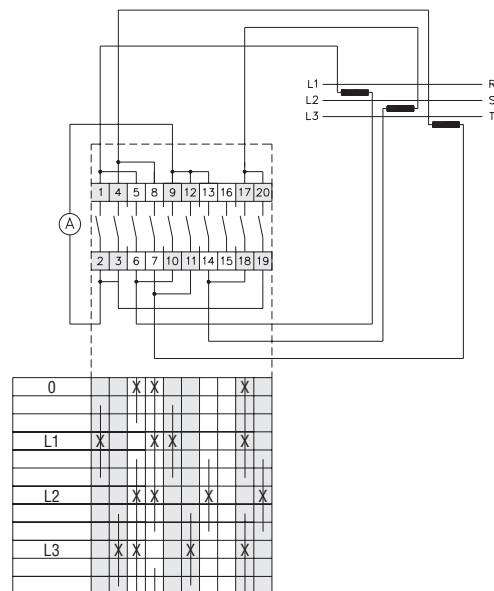
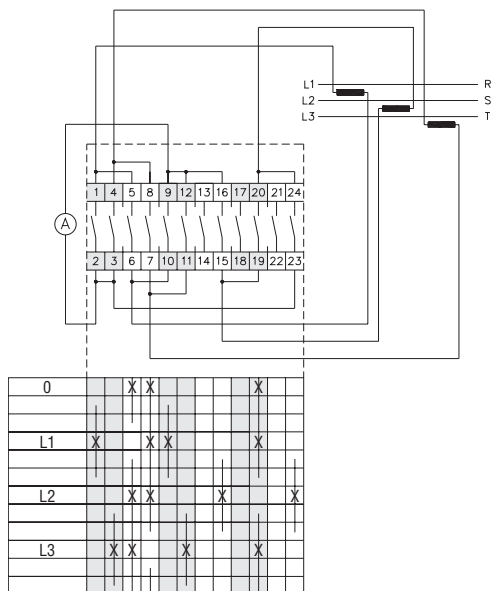

98

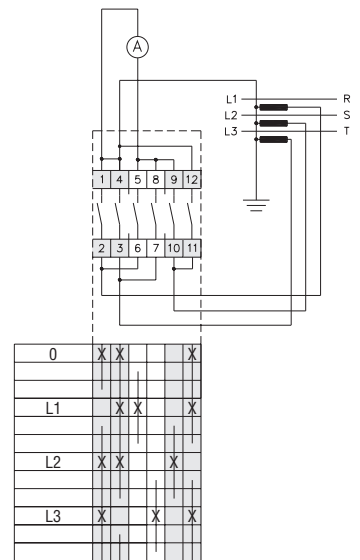

Dane techniczne

Seria	Prąd termiczny I _{th} [A]	Zastos. ogólne UL/CSA [A]	Moc maksymalna UL/CSA					Moc maks. wg IEC w AC23, 1F [kW] przy 230V	Moc maks. wg IEC w AC23, 3F [kW] przy 400V
			1 fazowy		3 fazowy				
			120V [HP]	240V [HP]	240V [HP]	480V [HP]	600V [HP]		
GF10...	10	10	—	0,75	2	—	—	0,75	3
GF20...	20	15	—	1	3	—	—	2	7,5
7GN12...	16	15	0,5	1	3	—	—	1,7	5,5
7GN20...	20	20	0,75	2	3	7,5	10	2,5	7,5
7GN25...	25	30	1,5	3	5	10	15	3,7	11
7GN32...	32	40	2	5	10	15	15	4	15
7GN40...	40	50	2	5	10	20	20	6	18,5

Seria	Prąd termiczny I _{th} [A]	Zastos. ogólne UL/CSA [A]	Moc maksymalna UL/CSA					Moc maks. wg IEC w AC23, 1F [kW] przy 230V	Moc maks. wg IEC w AC23, 3F [kW] przy 400V
			1 fazowy		3 fazowy				
			120V [HP]	240V [HP]	240V [HP]	480V [HP]	600V [HP]		
GX16...	16	12	0,75	1	3	5	5	1,8	6,5
GX20...	20	15	0,75	1,5	3	5	5	2,2	7,5
GX32...	32	32	1,5	3	7,5	15	15	3,5	15
GX40...	40	40	2	5	10	15	15	5,2	18,5

PRZELĄCZNIKI WOLTOMIERZY I AMPEROMIERZY

Wykonanie do montażu na płycie z czarnym pokrętkiem (wersja 0)



Typ				Przełączniki woltomierzy			Przełączniki amperomierzy	
SCHEMATY				66	67	68	97	98
Seria	Wymiary tabliczki [mm]	Prąd termiczny I _{th} [A]	Zastosowanie ogólne UL/CSA [A]					
GF...	48	20	15	GF20660	GF20670	GF20680	GF20970	GF20980
7GN...	48	16	15	7GN12660	7GN12670	7GN12680	7GN12970	7GN12980
		20	20	7GN20660	7GN20670	7GN20680	7GN20970	7GN20980
		25	30	7GN25660	7GN25670	7GN25680	7GN25970	7GN25980
	65	32	40	7GN32660	7GN32670	7GN32680	7GN32970	7GN32980
		40	50	7GN40660	7GN40670	7GN40680	7GN40970	7GN40980
GX...	48	16	12	GX16660	GX16670	GX16680	GX16970	GX16980
		20	15	GX20660	GX20670	GX20680	GX20970	GX20980
	65	32	32	GX32660	GX32670	GX32680	GX32970	GX32980
		40	40	GX40660	GX40670	GX40680	GX40970	GX40980

Wykonanie modułowe do montażu na szynie DIN z czarnym pokrętkiem (wersja 048) ①



Typ				Przełączniki woltomierzy			Przełączniki amperomierzy	
SCHEMATY				66	67	68	97	98
Seria	Wymiary tabliczki [mm]	Prąd termiczny I _{th} [A]	Zastosowanie ogólne UL/CSA [A]					
GF...	45x54	20	15	GF2066048	GF2067048	GF2068048	GF2097048	GF2098048
7GN...	45x54	16	15	7GN1266048	7GN1267048	7GN1268048	7GN1297048	7GN1298048
		20	20	7GN2066048	7GN2067048	7GN2068048	7GN2097048	7GN2098048
		25	30	7GN2566048	7GN2567048	7GN2568048	7GN2597048	7GN2598048
GX...	45x54	16	12	GX1666048	GX1667048	GX1668048	GX1697048	GX1698048
		20	15	GX2066048	GX2067048	GX2068048	GX2097048	GX2098048

① Dla wersji z kluczem zamienić 048 na 049 (np. GF2066049).

SCHEMATY

66

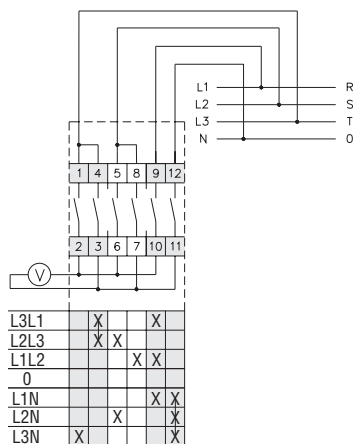

67

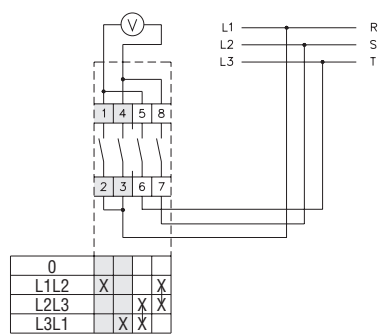

68

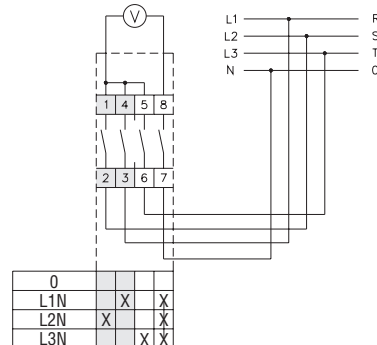

97

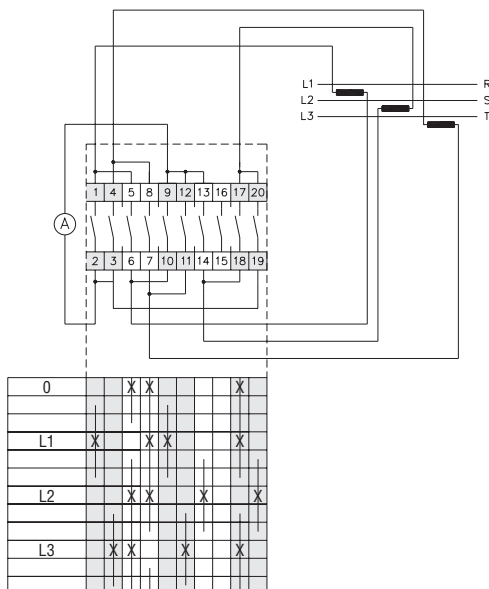
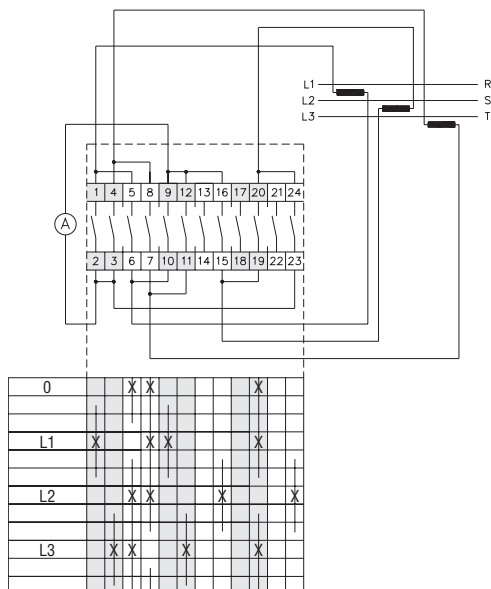

98

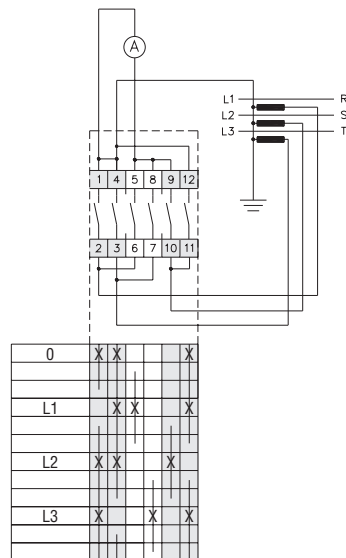

12

Dane techniczne

Seria	Prąd termiczny I _{th} [A]	Zastos. ogólne UL/CSA [A]	Moc maksymalna UL/CSA					Moc maks. wg IEC w AC23, 1F [kW] przy 230V	Moc maks. wg IEC w AC23, 3F [kW] przy 400V
			1 fazowy		3 fazowy				
			120V [HP]	240V [HP]	240V [HP]	480V [HP]	600V [HP]		
GF10...	10	10	—	0,75	2	—	—	0,75	3
GF20...	20	15	—	1	3	—	—	2	7,5
7GN12...	16	15	0,5	1	3	—	—	1,7	5,5
7GN20...	20	20	0,75	2	3	7,5	10	2,5	7,5
7GN25...	25	30	1,5	3	5	10	15	3,7	11
7GN32...	32	40	2	5	10	15	15	4	15
7GN40...	40	50	2	5	10	20	20	6	18,5

Seria	Prąd termiczny I _{th} [A]	Zastos. ogólne UL/CSA [A]	Moc maksymalna UL/CSA					Moc maks. wg IEC w AC23, 1F [kW] przy 230V	Moc maks. wg IEC w AC23, 3F [kW] przy 400V
			1 fazowy		3 fazowy				
			120V [HP]	240V [HP]	240V [HP]	480V [HP]	600V [HP]		
GX16...	16	12	0,75	1	3	5	5	1,8	6,5
GX20...	20	15	0,75	1,5	3	5	5	2,2	7,5
GX32...	32	32	1,5	3	7,5	15	15	3,5	15
GX40...	40	40	2	5	10	15	15	5,2	18,5

ZMIANA KIERUNKU OBROTÓW SILNIKA - GWIAZDA-TRÓJKĄT - UKŁADY DAHLANDERA - SILNIKI DWUBIEGOWE



Wykonanie do montażu tablicowego z czarnym pokrętkiem (wersja U)

Typ				Zmiana kierunku obrotów silnika			Gwiazda-trójkąt	Układy Dahlandera			Silniki dwubiegowe
SCHEMATY				25	11	26	12	13	19	20	53
Seria	Wymiary tabliczki [mm]	Prąd termiczny I _{th} [A]	Zastosowanie ogólne UL/CSA [A]								
GF...	<input type="checkbox"/> 30	10	10	GF1025U	GF1011U	GF1026U	GF1012U	GF1013U	GF1019U	GF1020U	GF1053U
	<input type="checkbox"/> 48	20	15	GF2025U	GF2011U	GF2026U	GF2012U	GF2013U	GF2019U	GF2020U	GF2053U
7GN...	<input type="checkbox"/> 48	16	15	7GN1225U	7GN1211U	7GN1226U	7GN1212U	7GN1213U	7GN1219U	7GN1220U	7GN1253U
		20	20	7GN2025U	7GN2011U	7GN2026U	7GN2012U	7GN2013U	7GN2019U	7GN2020U	7GN2053U
		25	30	7GN2525U	7GN2511U	7GN2526U	7GN2512U	7GN2513U	7GN2519U	7GN2520U	7GN2553U
	<input type="checkbox"/> 65	32	40	7GN3225U	7GN3211U	7GN3226U	7GN3212U	7GN3213U	7GN3219U	7GN3220U	7GN3253U
		40	50	7GN4025U	7GN4011U	7GN4026U	7GN4012U	7GN4013U	7GN4019U	7GN4020U	7GN4053U
		63	60	7GN6325U	7GN6311U	7GN6326U	7GN6312U	7GN6313U	7GN6319U	7GN6320U	7GN6353U
<input type="checkbox"/> 90	125	130	7GN12525U	7GN12511U	7GN12526U	7GN12512U	7GN12513U	7GN12519U	7GN12520U	7GN12553U	
GX...	<input type="checkbox"/> 48	16	12	GX1625U	GX1611U	GX1626U	GX1612U	GX1613U	GX1619U	GX1620U	GX1653U
		20	15	GX2025U	GX2011U	GX2026U	GX2012U	GX2013U	GX2019U	GX2020U	GX2053U
	<input type="checkbox"/> 65	32	32	GX3225U	GX3211U	GX3226U	GX3212U	GX3213U	GX3219U	GX3220U	GX3253U
		40	40	GX4025U	GX4011U	GX4026U	GX4012U	GX4013U	GX4019U	GX4020U	GX4053U
GN...	<input type="checkbox"/> 132	200	200	GN20025U	GN20011U	GN20026U	GN20012U	GN20013U	GN20019U	GN20020U	GN20053U
		315	255	GN31525U	GN31511U	GN31526U	GN31512U	GN31513U	GN31519U	GN31520U	GN31553U



Wykonanie do montażu tablicowego z żółto/czerwonym pokrętkiem blokowanym kłódką w pozycji 0 i osłonami zacisków (wersja U25) ③

Typ				Zmiana kierunku obrotów silnika			Gwiazda-trójkąt	Układy Dahlandera			Silniki dwubiegowe
SCHEMATY				25	11	26	12	13	19	20	53
Seria	Wymiary tabliczki [mm]	Prąd termiczny I _{th} [A]	Zastosowanie ogólne UL/CSA [A]								
GF...	<input type="checkbox"/> 48	20	15	GF2025U25	GF2011U25	GF2026U25	GF2012U25	GF2013U25	GF2019U25	GF2020U25	GF2053U25
	<input type="checkbox"/> 65	16	12	GX1625U25	GX1611U25	GX1626U25	GX1612U25	GX1613U25	GX1619U25	GX1620U25	GX1653U25
20		15	GX2025U25	GX2011U25	GX2026U25	GX2012U25	GX2013U25	GX2019U25	GX2020U25	GX2053U25	
32		32	GX3225U25	GX3211U25	GX3226U25	GX3212U25	GX3213U25	GX3219U25	GX3220U25	GX3253U25	
40		40	GX4025U25	GX4011U25	GX4026U25	GX4012U25	GX4013U25	GX4019U25	GX4020U25	GX4053U25	

① Tabliczka do GF20..., 7GN..., GX...

② Tabliczka do GF10..., GN...

③ Dla wersji bez blokady kłódką i bez osłon należy zamienić U25 na U24 (np. GF1025U24).

SCHEMATY

25

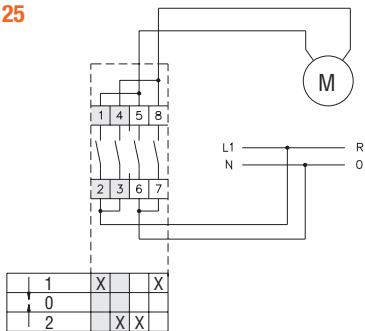

11

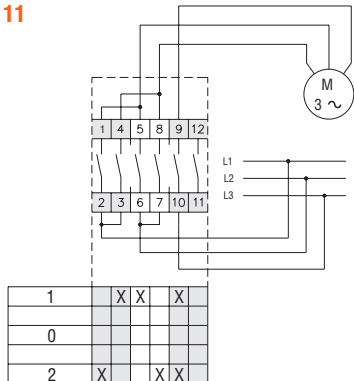

26

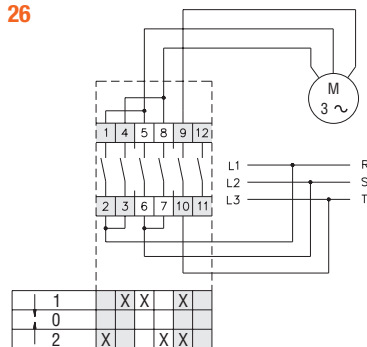

12

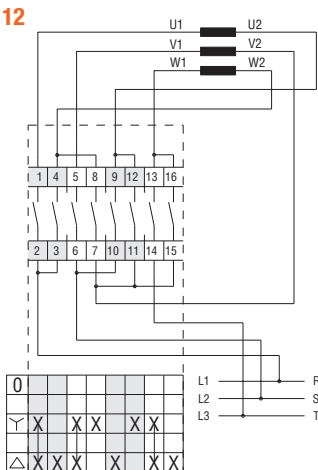

13

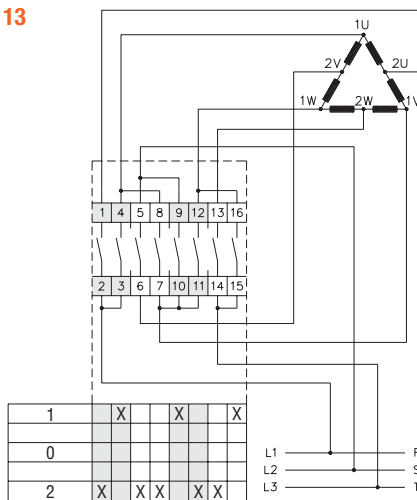

19

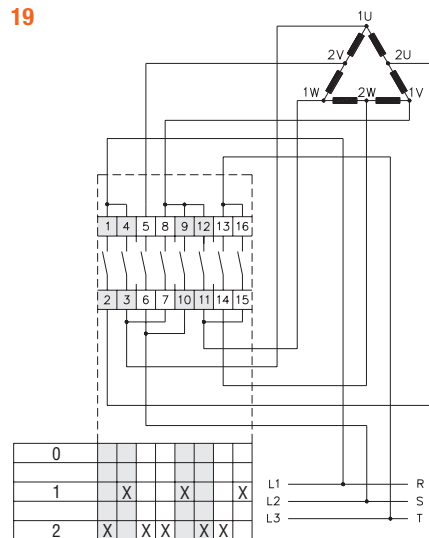

20

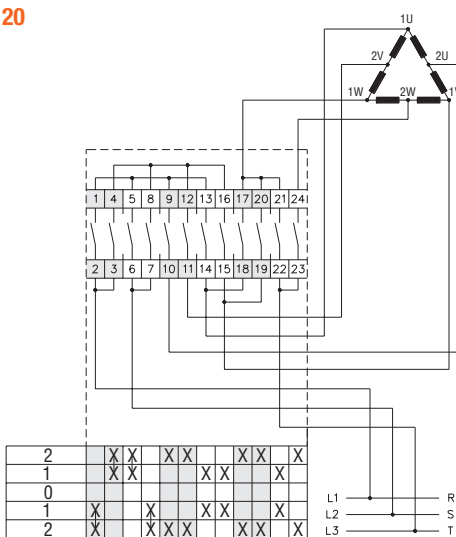

53

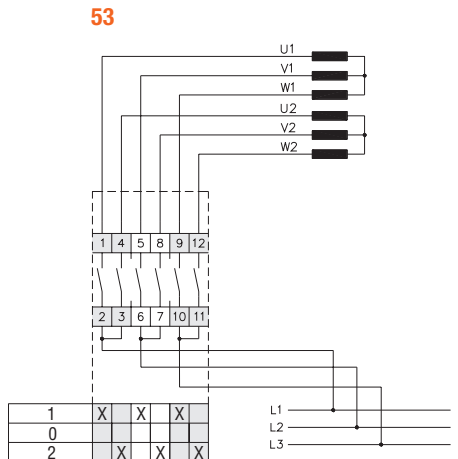

Dane techniczne

Seria	Prąd termiczny I _{th} [A]	Zastos. ogólne UL/CSA [A]	Moc maksymalna UL/CSA					Moc maks. wg IEC w AC23, 1F [kW] przy 230V	Moc maks. wg IEC w AC23, 3F [kW] przy 400V
			1 fazowy		3 fazowy				
			120V [HP]	240V [HP]	240V [HP]	480V [HP]	600V [HP]		
GF10...	10	10	—	0,75	2	—	—	0,75	3
GF20...	20	15	—	1	3	—	—	2	7,5
7GN12...	16	15	0,5	1	3	—	—	1,7	5,5
7GN20...	20	20	0,75	2	3	7,5	10	2,5	7,5
7GN25...	25	30	1,5	3	5	10	15	3,7	11
7GN32...	32	40	2	5	10	15	15	4	15
7GN40...	40	50	2	5	10	20	20	6	18,5
7GN63...	63	60	3	10	15	25	25	7,5	30
7GN125...	125	130	5	15	25	50	40	11	45

Seria	Prąd termiczny I _{th} [A]	Zastos. ogólne UL/CSA [A]	Moc maksymalna UL/CSA					Moc maks. wg IEC w AC23, 1F [kW] przy 230V	Moc maks. wg IEC w AC23, 3F [kW] przy 400V
			1 fazowy		3 fazowy				
			120V [HP]	240V [HP]	240V [HP]	480V [HP]	600V [HP]		
GX16...	16	12	0,75	1	3	5	5	1,8	6,5
GX20...	20	15	0,75	1,5	3	5	5	2,2	7,5
GX32...	32	32	1,5	3	7,5	15	15	3,5	15
GX40...	40	40	2	5	10	15	15	5,2	18,5
GN200	200	200	15	30	50	100	75	—	47
GN315	315	255	15	30	50	100	75	37	110

ZMIANA KIERUNKU OBROTÓW SILNIKA - GWIAZDA-TRÓJKĄT - UKŁADY DAHLANDERA - SILNIKI DWUBIEGOWE

Wykonanie do montażu tablicowego z żółto/czerwonym pokrętkiem blokowanym kłódką w pozycji 0 i osłonami zacisków (wersja U65)



Typ				Zmiana kierunku obrotów silnika			Gwiazda-trójkąt	Układy Dahlandera			Silniki dwubiegowe
SCHEMATY				25	11	26	12	13	19	20	53
Seria	Wymiary tabliczki	Prąd termiczny I _{th}	Zastosowanie ogólne UL/CSA								
	[mm]	[A]	[A]								
7GN...	□65	16	15	7GN1225U65	7GN1211U65	7GN1226U65	7GN1212U65	7GN1213U65	7GN1219U65	7GN1220U65	7GN1253U65
		20	20	7GN2025U65	7GN2011U65	7GN2026U65	7GN2012U65	7GN2013U65	7GN2019U65	7GN2020U65	7GN2053U65
		25	30	7GN2525U65	7GN2511U65	7GN2526U65	7GN2512U65	7GN2513U65	7GN2519U65	7GN2520U65	7GN2553U65
		32	40	7GN3225U65	7GN3211U65	7GN3226U65	7GN3212U65	7GN3213U65	7GN3219U65	7GN3220U65	7GN3253U65
		40	50	7GN4025U65	7GN4011U65	7GN4026U65	7GN4012U65	7GN4013U65	7GN4019U65	7GN4020U65	7GN4053U65
		63	60	7GN6325U65	7GN6311U65	7GN6326U65	7GN6312U65	7GN6313U65	7GN6319U65	7GN6320U65	7GN6353U65
	□90	125	130	7GN12525U65	7GN12511U65	7GN12526U65	7GN12512U65	7GN12513U65	7GN12519U65	7GN12520U65	7GN12553U65

Wykonanie do montażu tablicowego w otworze Ø22mm z czarnym pokrętkiem montowanym na zatrzask (wersja U47) ❶



Typ				Zmiana kierunku obrotów silnika			Gwiazda-trójkąt	Układy Dahlandera			Silniki dwubiegowe
SCHEMATY				25	11	26	12	13	19	20	53
Seria	Wymiary tabliczki	Prąd termiczny I _{th}	Zastosowanie ogólne UL/CSA								
	[mm]	[A]	[A]								
GF...	□30	10	10	GF1025U47	GF1011U47	GF1026U47	GF1012U47	GF1013U47	GF1019U47	GF1020U47	GF1053U47
		20	15	GF2025U47	GF2011U47	GF2026U47	GF2012U47	GF2013U47	GF2019U47	GF2020U47	GF2053U47
7GN...	□48	16	15	7GN1225U47	7GN1211U47	7GN1226U47	7GN1212U47	7GN1213U47	7GN1219U47	7GN1220U47	7GN1253U47
		20	20	7GN2025U47	7GN2011U47	7GN2026U47	7GN2012U47	7GN2013U47	7GN2019U47	7GN2020U47	7GN2053U47
		25	30	7GN2525U47	7GN2511U47	7GN2526U47	7GN2512U47	7GN2513U47	7GN2519U47	7GN2520U47	7GN2553U47
GX...	□48	16	12	GX1625U47	GX1611U47	GX1626U47	GX1612U47	GX1613U47	GX1619U47	GX1620U47	GX1653U47
		20	15	GX2025U47	GX2011U47	GX2026U47	GX2012U47	GX2013U47	GX2019U47	GX2020U47	GX2053U47

❶ Dla wersji z kluczem zamienić U47 na U29D (np. GF2025U29D).

❷ Tabliczka do GF20..., 7GN..., GX...

❸ Tabliczka do GF10..., GN...

SCHEMATY

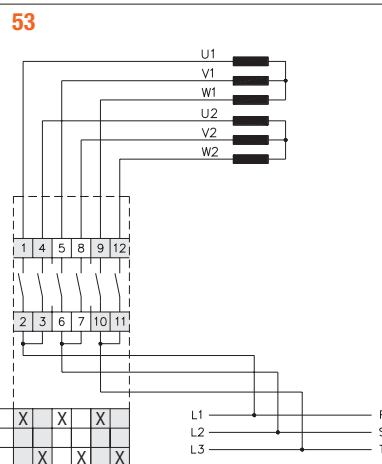
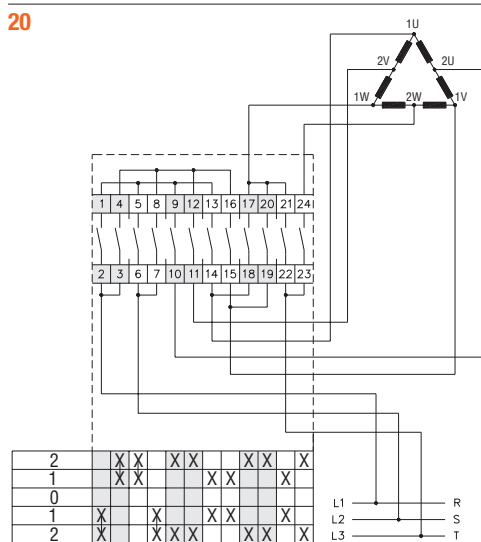
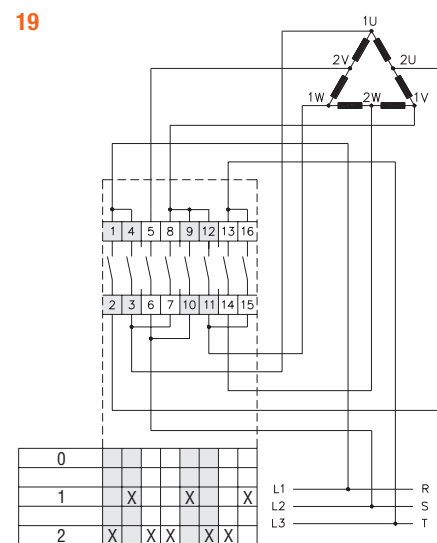
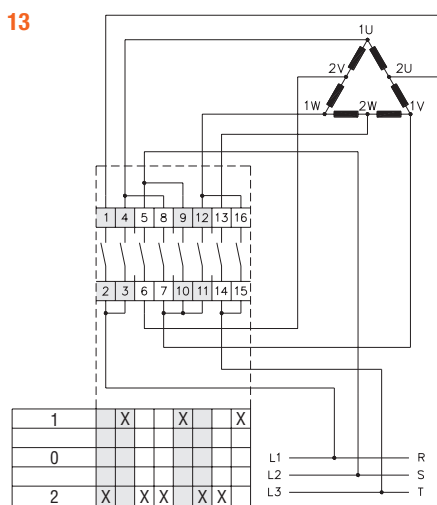
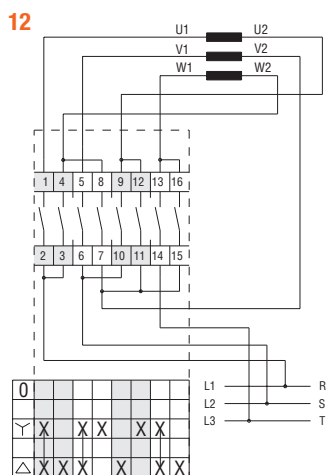
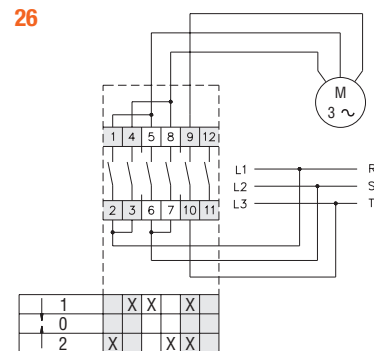
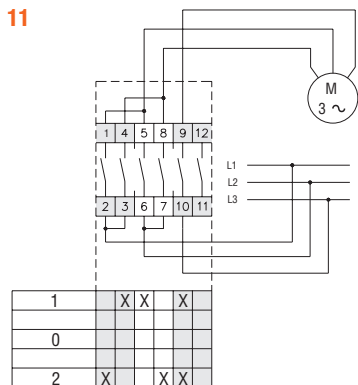
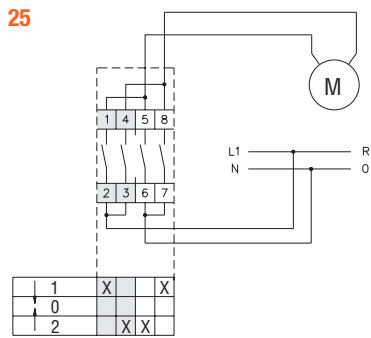

Dane techniczne

Seria	Prąd termiczny I _{th} [A]	Zastos. ogólne UL/CSA [A]	Moc maksymalna UL/CSA					Moc maks. wg IEC w AC23, 1F [kW] przy 230V	Moc maks. wg IEC w AC23, 3F [kW] przy 400V
			1 fazowy		3 fazowy				
			120V [HP]	240V [HP]	240V [HP]	480V [HP]	600V [HP]		
GF10...	10	10	—	0,75	2	—	—	0,75	3
GF20...	20	15	—	1	3	—	—	2	7,5
7GN12...	16	15	0,5	1	3	—	—	1,7	5,5
7GN20...	20	20	0,75	2	3	7,5	10	2,5	7,5
7GN25...	25	30	1,5	3	5	10	15	3,7	11
7GN32...	32	40	2	5	10	15	15	4	15
7GN40...	40	50	2	5	10	20	20	6	18,5
7GN63...	63	60	3	10	15	25	25	7,5	30
7GN125...	125	130	5	15	25	50	40	11	45

Seria	Prąd termiczny I _{th} [A]	Zastos. ogólne UL/CSA [A]	Moc maksymalna UL/CSA					Moc maks. wg IEC w AC23, 1F [kW] przy 230V	Moc maks. wg IEC w AC23, 3F [kW] przy 400V
			1 fazowy		3 fazowy				
			120V [HP]	240V [HP]	240V [HP]	480V [HP]	600V [HP]		
GX16...	16	12	0,75	1	3	5	5	1,8	6,5
GX20...	20	15	0,75	1,5	3	5	5	2,2	7,5

ZMIANA KIERUNKU OBROTÓW SILNIKA - GWIAZDA-TRÓJKĄT - UKŁADY DAHLANDERA - SILNIKI DWUBIEGOWE



Wykonanie do montażu na płycie z czarnym pokrętkiem (wersja 0)

Typ				Zmiana kierunku obrotów silnika			Gwiazda-trójkąt	Układy Dahlandera			Silniki dwubiegowe	
SCHEMATY				25	11	26	12	13	19	20	53	
Seria	Wymiary tabliczki [mm]	Prąd termiczny I _{th} [A]	Zastosowanie ogólne UL/CSA [A]									
GF...	<input type="checkbox"/> 48	20	15	GF20250	GF20110	GF20260	GF20120	GF20130	GF20190	GF20200	GF20530	
7GN...	<input type="checkbox"/> 48	16	15	7GN12250	7GN12110	7GN12260	7GN12120	7GN12130	7GN12190	7GN12200	7GN12530	
		20	20	7GN20250	7GN20110	7GN20260	7GN20120	7GN20130	7GN20190	7GN20200	7GN20530	
		25	30	7GN25250	7GN25110	7GN25260	7GN25120	7GN25130	7GN25190	7GN25200	7GN25530	
	<input type="checkbox"/> 65	32	40	7GN32250	7GN32110	7GN32260	7GN32120	7GN32130	7GN32190	7GN32200	7GN32530	
		40	50	7GN40250	7GN40110	7GN40260	7GN40120	7GN40130	7GN40190	7GN40200	7GN40530	
<input type="checkbox"/> 90	125	130	7GN125250	7GN125110	7GN125260	7GN125120	7GN125130	7GN125190	7GN125200	7GN125530		
GX...	<input type="checkbox"/> 48	16	12	GX16250	GX16110	GX16260	GX16120	GX16130	GX16190	GX16200	GX16530	
		20	15	GX20250	GX20110	GX20260	GX20120	GX20130	GX20190	GX20200	GX20530	
	<input type="checkbox"/> 65	32	32	GX32250	GX32110	GX32260	GX32120	GX32130	GX32190	GX32200	GX32530	
		40	40	GX40250	GX40110	GX40260	GX40120	GX40130	GX40190	GX40200	GX40530	
GN...	<input type="checkbox"/> 132	200	200	GN200250	GN200110	GN200260	GN200120	GN200130	GN200190	GN200200	GN200530	
		315	255	GN315250	GN315110	GN315260	GN315120	GN315130	GN315190	GN315200	GN315530	



Wykonanie modułowe do montażu na szynie DIN z czarnym pokrętkiem (wersja 048) ③

Typ				Zmiana kierunku obrotów silnika			Gwiazda-trójkąt	Układy Dahlandera			Silniki dwubiegowe	
SCHEMATY				25	11	26	12	13	19	20	53	
Seria	Wymiary tabliczki [mm]	Prąd termiczny I _{th} [A]	Zastosowanie ogólne UL/CSA [A]									
GF...	45x54	20	15	GF2025048	GF2011048	GF2026048	GF2012048	GF2013048	GF2019048	GF2020048	GF2053048	
7GN...	45x54	16	15	7GN1225048	7GN1211048	7GN1226048	7GN1212048	7GN1213048	7GN1219048	7GN1220048	7GN1253048	
		20	20	7GN2025048	7GN2011048	7GN2026048	7GN2012048	7GN2013048	7GN2019048	7GN2020048	7GN2053048	
		25	30	7GN2525048	7GN2511048	7GN2526048	7GN2512048	7GN2513048	7GN2519048	7GN2520048	7GN2553048	
GX...	45x54	16	12	GX1625048	GX1611048	GX1626048	GX1612048	GX1613048	GX1619048	GX1620048	GX1653048	
		20	15	GX2025048	GX2011048	GX2026048	GX2012048	GX2013048	GX2019048	GX2020048	GX2053048	

① Tabliczka do GF20..., 7GN..., GX...

② Tabliczka do GF10..., GN...

③ Dla wersji z kluczem zmienić 048 na 049 (np. GF2025049).

SCHEMATY

25

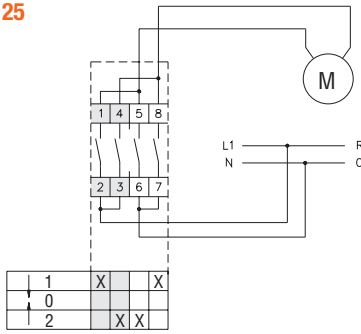

11

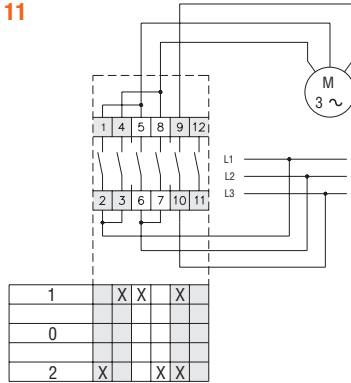

26

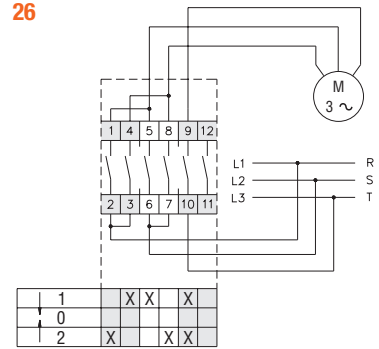

12

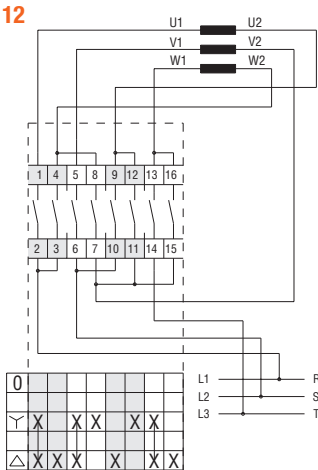

13

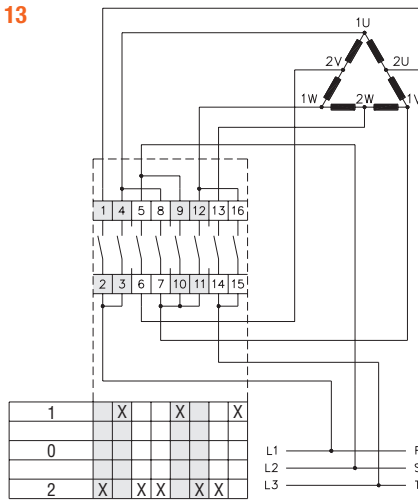

19

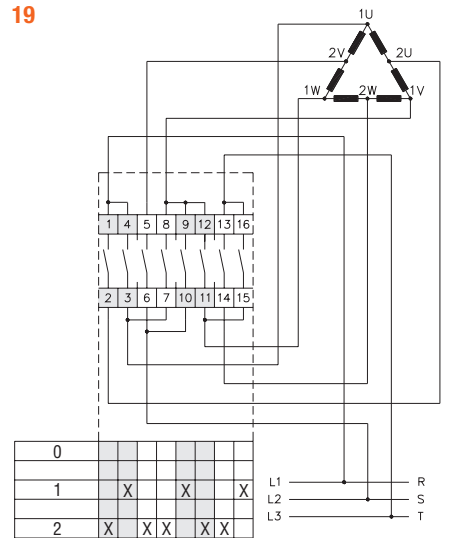

20

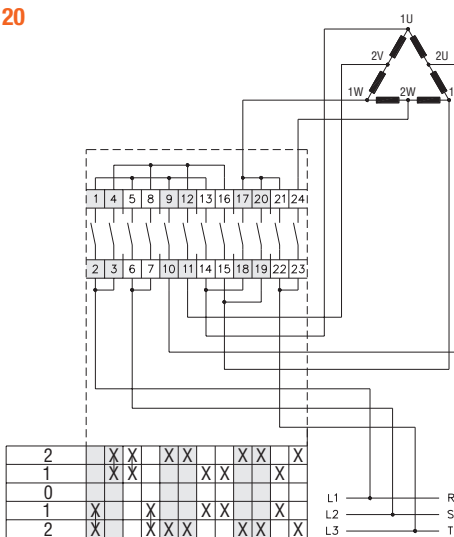

53

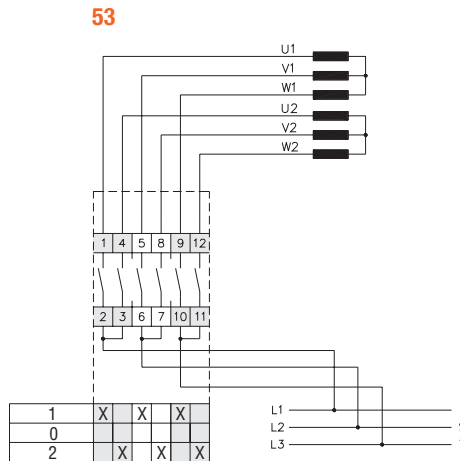

Dane techniczne

Seria	Prąd termiczny I _{th} [A]	Zastos. ogólne UL/CSA [A]	Moc maksymalna UL/CSA					Moc maks. wg IEC w AC23, 1F [kW] przy 230V	Moc maks. wg IEC w AC23, 3F [kW] przy 400V
			1 fazowy		3 fazowy				
			120V [HP]	240V [HP]	240V [HP]	480V [HP]	600V [HP]		
GF20...	20	15	—	1	3	—	2	7,5	
7GN12...	16	15	0,5	1	3	—	1,7	5,5	
7GN20...	20	20	0,75	2	3	7,5	10	7,5	
7GN25...	25	30	1,5	3	5	10	15	11	
7GN32...	32	40	2	5	10	15	15	15	
7GN40...	40	50	2	5	10	20	20	18,5	
7GN63...	63	60	3	10	15	25	25	30	
7GN125...	125	130	5	15	25	50	40	45	

Seria	Prąd termiczny I _{th} [A]	Zastos. ogólne UL/CSA [A]	Moc maksymalna UL/CSA					Moc maks. wg IEC w AC23, 1F [kW] przy 230V	Moc maks. wg IEC w AC23, 3F [kW] przy 400V
			1 fazowy		3 fazowy				
			120V [HP]	240V [HP]	240V [HP]	480V [HP]	600V [HP]		
GX16...	16	12	0,75	1	3	5	5	1,8	6,5
GX20...	20	15	0,75	1,5	3	5	5	2,2	7,5
GX32...	32	32	1,5	3	7,5	15	15	3,5	15
GX40...	40	40	2	5	10	15	15	5,2	18,5
GN200	200	200	15	30	50	100	75	—	47
GN315	315	255	15	30	50	100	75	37	110

ZMIANA KIERUNKU OBROTÓW SILNIKA - GWIAZDA-TRÓJKĄT - UKŁADY DAHLANDERA - SILNIKI DWUBIEGOWE

Wykonanie do montażu na płycie z żółto/czerwonym pokrętkiem blokowanym w pozycji 0, funkcją blokady drzwi i osłonami zacisków (wersja 088)

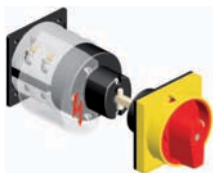

Typ				Zmiana kierunku obrotów silnika			Gwiazda-trójkąt	Układy Dahlandera			Silniki dwubiegowe
SCHEMATY				25	11	26	12	13	19	20	53
Seria	Wymiary tabliczki [mm]	Prąd termiczny I _{th} [A]	Zastosowanie ogólne UL/CSA [A]								
GF...	□48	20	15	GF2025088	GF2011088	GF2026088	GF2012088	GF2013088	GF2019088	GF2020088	GF2053088
GX...	□48	16	12	GX1625088	GX1611088	GX1626088	GX1612088	GX1613088	GX1619088	GX1620088	GX1653088
		20	15	GX2025088	GX2011088	GX2026088	GX2012088	GX2013088	GX2019088	GX2020088	GX2053088
	□65	32	32	GX3225088	GX3211088	GX3226088	GX3212088	GX3213088	GX3219088	GX3220088	GX3253088
		40	40	GX4025088	GX4011088	GX4026088	GX4012088	GX4013088	GX4019088	GX4020088	GX4053088

Wykonanie do montażu na płycie z żółto/czerwonym pokrętkiem blokowanym w pozycji 0, funkcją blokady drzwi i osłonami zacisków (wersja 098)



Typ				Zmiana kierunku obrotów silnika			Gwiazda-trójkąt	Układy Dahlandera			Silniki dwubiegowe
SCHEMATY				25	11	26	12	13	19	20	53
Seria	Wymiary tabliczki [mm]	Prąd termiczny I _{th} [A]	Zastosowanie ogólne UL/CSA [A]								
7GN...	□65	16	15	7GN1225098	7GN1211098	7GN1226098	7GN1212098	7GN1213098	7GN1219098	7GN1220098	7GN1253098
		20	20	7GN2025098	7GN2011098	7GN2026098	7GN2012098	7GN2013098	7GN2019098	7GN2020098	7GN2053098
		25	30	7GN2525098	7GN2511098	7GN2526098	7GN2512098	7GN2513098	7GN2519098	7GN2520098	7GN2553098
		32	40	7GN3225098	7GN3211098	7GN3226098	7GN3212098	7GN3213098	7GN3219098	7GN3220098	7GN3253098
		40	50	7GN4025098	7GN4011098	7GN4026098	7GN4012098	7GN4013098	7GN4019098	7GN4020098	7GN4053098

SCHEMATY

25

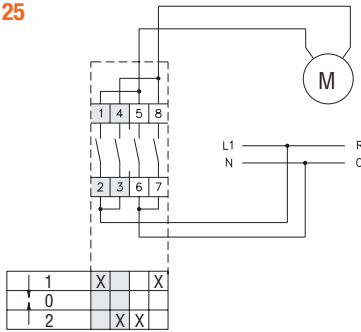

11

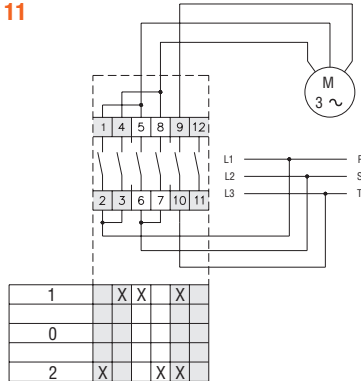

26

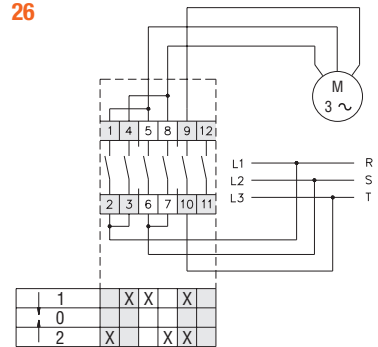

12

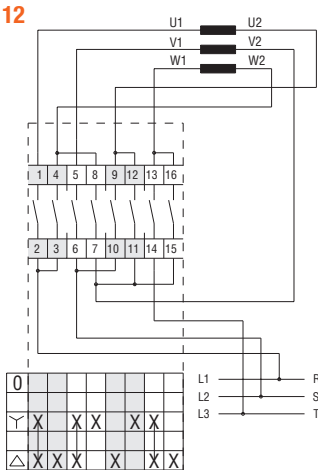

13

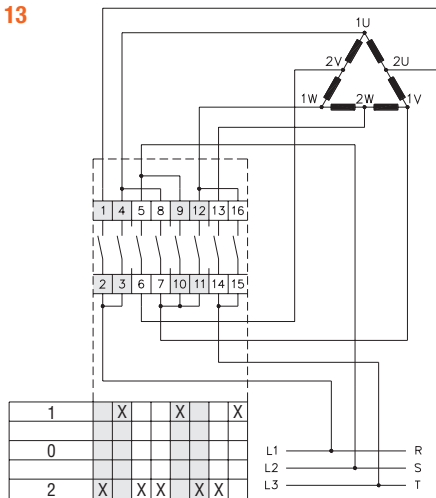

19

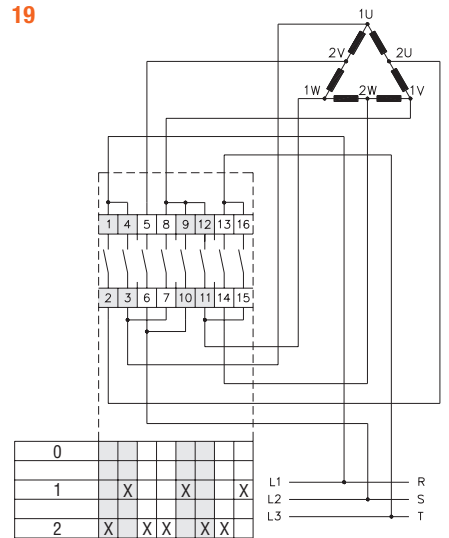

12

20

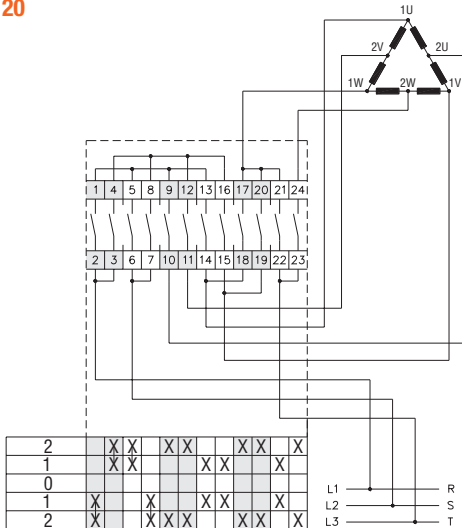

53

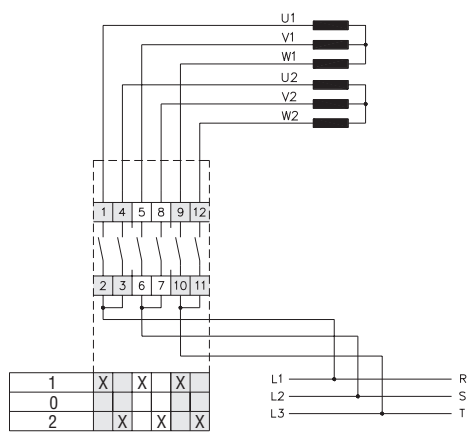

Dane techniczne

Seria	Prąd termiczny I _{th} [A]	Zastos. ogólne UL/CSA [A]	Moc maksymalna UL/CSA					Moc maks. wg IEC w AC23, 1F [kW] przy 230V	Moc maks. wg IEC w AC23, 3F [kW] przy 400V
			1 fazowy		3 fazowy				
			120V [HP]	240V [HP]	240V [HP]	480V [HP]	600V [HP]		
GF20...	20	15	—	1	3	—	2	7,5	
7GN12...	16	15	0,5	1	3	—	1,7	5,5	
7GN20...	20	20	0,75	2	3	7,5	2,5	7,5	
7GN25...	25	30	1,5	3	5	10	3,7	11	
7GN32...	32	40	2	5	10	15	4	15	
7GN40...	40	50	2	5	10	20	6	18,5	

Seria	Prąd termiczny I _{th} [A]	Zastos. ogólne UL/CSA [A]	Moc maksymalna UL/CSA					Moc maks. wg IEC w AC23, 1F [kW] przy 230V	Moc maks. wg IEC w AC23, 3F [kW] przy 400V
			1 fazowy		3 fazowy				
			120V [HP]	240V [HP]	240V [HP]	480V [HP]	600V [HP]		
GX16...	16	12	0,75	1	3	5	5	1,8	6,5
GX20...	20	15	0,75	1,5	3	5	5	2,2	7,5
GX32...	32	32	1,5	3	7,5	15	15	3,5	15
GX40...	40	40	2	5	10	15	15	5,2	18,5

ZMIANA KIERUNKU OBROTÓW SILNIKA - GWIAZDA-TRÓJKĄT - UKŁADY DAHLANDERA - SILNIKI DWUBIEGOWE

Wykonanie w obudowie z tworzywa z czarnym pokrętkiem (wersja P)
 Wykonanie w obudowie z metalu z czarnym pokrętkiem (wersja L)



Typ				Zmiana kierunku obrotów silnika			Gwiazda-trójkąt	Układy Dahlandera			Silniki dwubiegowe
SCHEMATY				25	11	26	12	13	19	20	53
Seria	Wymiary tabliczki	Prąd termiczny I _{th}	Zastosowanie ogólne UL/CSA								
				[mm]	[A]	[A]					
7GN...	75x75	16	15	7GN1225P	7GN1211P	7GN1226P	7GN1212P	7GN1213P	7GN1219P	—	7GN1253P
		20	20	7GN2025P	7GN2011P	7GN2026P	7GN2012P	7GN2013P	7GN2019P	—	7GN2053P
		25	30	7GN2525P	7GN2511P	7GN2526P	7GN2512P [Ⓢ]	7GN2513P [Ⓢ]	7GN2519P [Ⓢ]	—	7GN2553P
	90x90	32	40	7GN3225P	7GN3211P	7GN3226P	7GN3212P	7GN3213P	7GN3219P	—	7GN3253P
		40	50	7GN4025P	7GN4011P	7GN4026P	7GN4012P	7GN4013P	7GN4019P	—	7GN4053P
		63	60	7GN6325P	7GN6311P	7GN6326P	7GN6312P	7GN6313P	7GN6319P	—	7GN6353P
198x248	125	130	7GN12525P	7GN12511P	7GN12526P	7GN12512P	7GN12513P	7GN12519P	—	7GN12553P	
GX...	90x90	16	12	GX1625P	GX1611P	GX1626P	GX1612P	GX1613P	GX1619P	—	GX1653P
		20	15	GX2025P	GX2011P	GX2026P	GX2012P	GX2013P	GX2019P	—	GX2053P
	110x110	32	32	GX3225P	GX3211P	GX3226P	GX3212P	GX3213P	GX3219P	—	GX3253P
		40	40	GX4025P	GX4011P	GX4026P	GX4012P	GX4013P	GX4019P	—	GX4053P
GN...	250x316	200	200	GN20025L	GN20011L	GN20026L	GN20012L	GN20013L	GN20019L	GN20020L	GN20053L
		315	255	GN31525L	GN31511L	GN31526L	GN31512L	GN31513L	GN31519L	GN31520L	GN31553L

Wykonanie w obudowie z tworzywa z żółto/czerwonym pokrętkiem blokowanym w pozycji 0 (wersja P25)



Typ				Zmiana kierunku obrotów silnika			Gwiazda-trójkąt	Układy Dahlandera			Silniki dwubiegowe
SCHEMATY				25	11	26	12	13	19	53	
Seria	Wymiary tabliczki	Prąd termiczny I _{th}	Zastosowanie ogólne UL/CSA								
				[mm]	[A]	[A]					
7GN...	90x90	16	15	7GN1225P25	7GN1211P25	7GN1226P25	7GN1212P25	7GN1213P25	7GN1219P25	7GN1253P25	
		20	20	7GN2025P25	7GN2011P25	7GN2026P25	7GN2012P25	7GN2013P25	7GN2019P25	7GN2053P25	
		25	30	7GN2525P25	7GN2511P25	7GN2526P25	7GN2512P25 [Ⓢ]	7GN2513P25 [Ⓢ]	7GN2519P25 [Ⓢ]	7GN2553P25	
	90x90	32	40	7GN3225P25	7GN3211P25	7GN3226P25	7GN3212P25	7GN3213P25	7GN3219P25	7GN3253P25	
		40	50	7GN4025P25	7GN4011P25	7GN4026P25	7GN4012P25	7GN4013P25	7GN4019P25	7GN4053P25	
		63	60	7GN6325P25	7GN6311P25	7GN6326P25	7GN6312P25	7GN6313P25	7GN6319P25	7GN6353P25	
198x248	125	130	7GN12525P25	7GN12511P25	7GN12526P25	7GN12512P25	7GN12513P25	7GN12519P25	7GN12553P25		
GX...	90x90	16	12	GX1625P25	GX1611P25	GX1626P25	GX1612P25	GX1613P25	GX1619P25	GX1653P25	
		20	15	GX2025P25	GX2011P25	GX2026P25	GX2012P25	GX2013P25	GX2019P25	GX2053P25	
	110x110	32	32	GX3225P25	GX3211P25	GX3226P25	GX3212P25	GX3213P25	GX3219P25	GX3253P25	
		40	40	GX4025P25	GX4011P25	GX4026P25	GX4012P25	GX4013P25	GX4019P25	GX4053P25	

Ⓢ Wymiary obudowy 90x90mm.

SCHEMATY

25

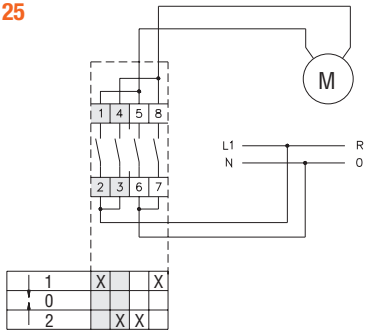

11

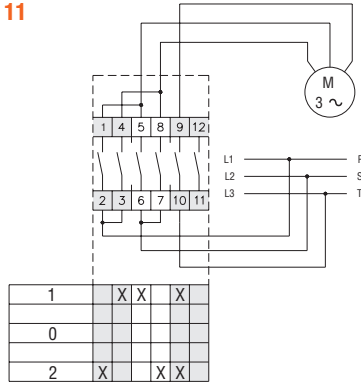

26

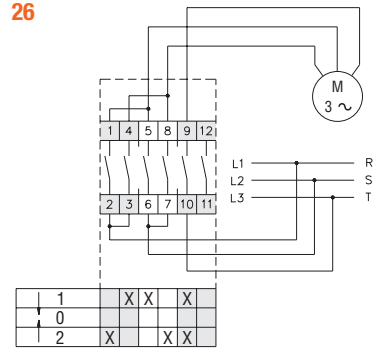

12

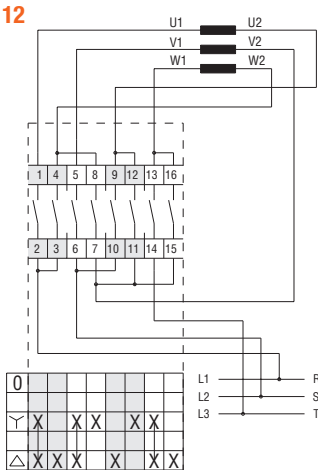

13

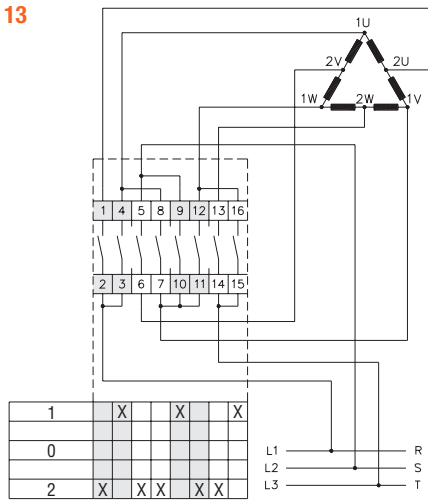

19

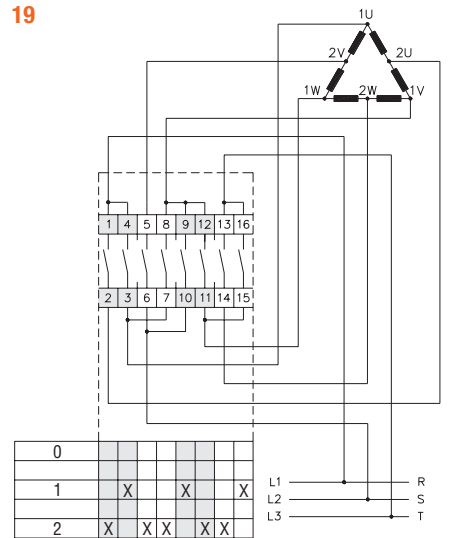

20

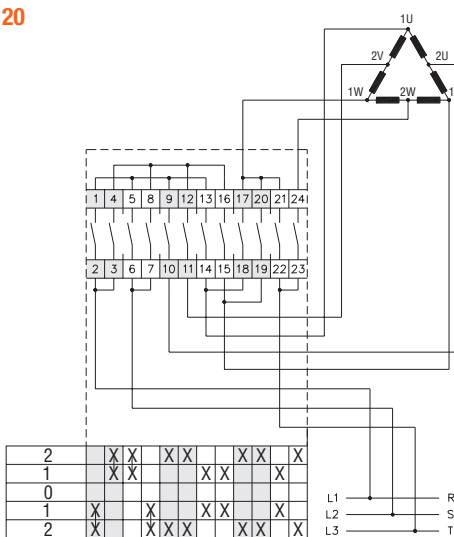

53

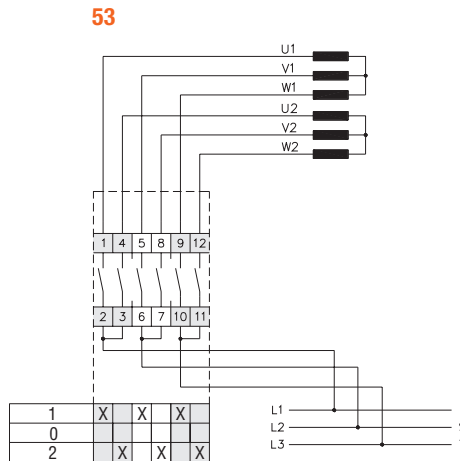

Dane techniczne

Seria	Prąd termiczny I _{th} [A]	Zastos. ogólne UL/CSA [A]	Moc maksymalna UL/CSA					Moc maks. wg IEC w AC23, 1F [kW] przy 230V	Moc maks. wg IEC w AC23, 3F [kW] przy 400V
			1 fazowy		3 fazowy				
			120V [HP]	240V [HP]	240V [HP]	480V [HP]	600V [HP]		
7GN12...	16	15	0,5	1	3	—	1,7	5,5	
7GN20...	20	20	0,75	2	3	7,5	10	2,5	7,5
7GN25...	25	30	1,5	3	5	10	15	3,7	11
7GN32...	32	40	2	5	10	15	15	4	15
7GN40...	40	50	2	5	10	20	20	6	18,5
7GN63...	63	60	3	10	15	25	25	7,5	30
7GN125...	125	130	5	15	25	50	40	11	45

Seria	Prąd termiczny I _{th} [A]	Zastos. ogólne UL/CSA [A]	Moc maksymalna UL/CSA					Moc maks. wg IEC w AC23, 1F [kW] przy 230V	Moc maks. wg IEC w AC23, 3F [kW] przy 400V
			1 fazowy		3 fazowy				
			120V [HP]	240V [HP]	240V [HP]	480V [HP]	600V [HP]		
GX16...	16	12	0,75	1	3	5	5	1,8	6,5
GX20...	20	15	0,75	1,5	3	5	5	2,2	7,5
GX32...	32	32	1,5	3	7,5	15	15	3,5	15
GX40...	40	40	2	5	10	15	15	5,2	18,5
GN200	200	200	15	30	50	100	75	—	47
GN315	315	255	15	30	50	100	75	37	110

Wykonanie do montażu tablicowego z czarnym pokrętkiem (wersja U)



GF..

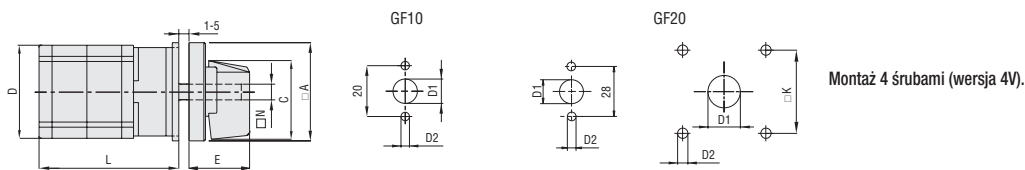

Montaż 4 śrubami (wersja 4V).

Seria	Wymiary								L Liczba segmentów (warstw)											
	□A	C	D	∅D1	∅D2	E	□K	N	1	2	3	4	5	6	7	8	9	10	11	12
GF10	30	24	29	9	3,2	18,5	-	∅5	40	52	64	76	88	100	112	124	-	-	-	-
GF20	48	39,5	36	12	5	26,5	36	□6	44	57,5	71	84,5	98	111,5	125	138,5	152	165,5	179	192,5



7GN...

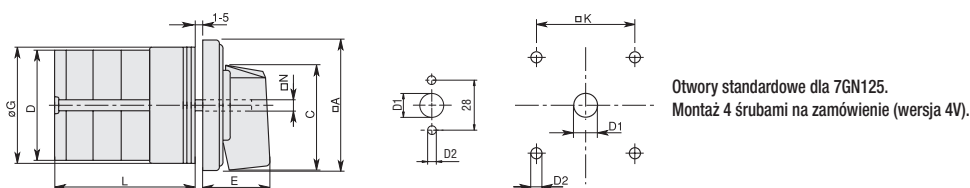

Otwory standardowe dla 7GN125.
Montaż 4 śrubami na zamówienie (wersja 4V).

Seria	Wymiary									L Liczba segmentów (warstw)											
	□A	C	∅D	∅D1	∅D2	E	∅G	□K	□N	1	2	3	4	5	6	7	8	9	10	11	12
7GN12	48	39,5	39	12	5	26,5	38	36	6	36,1	45,8	55,5	65,2	74,9	84,6	94,3	104	113,7	123,4	133,1	142,8
7GN20	48	39,5	39	12	5	26,5	38	36	6	36,1	45,8	55,5	65,2	74,9	84,6	94,3	104	113,7	123,4	133,1	142,8
7GN25	48	39,5	43	12	5	26,5	38	36	6	40,5	54,1	67,7	81,3	94,9	108,5	122,1	135,7	147,3	162,9	176,5	190,1
7GN32	65	53	58	14	5	34,5	58,5	48	7	46,5	61,6	76,7	91,8	106,9	122	137,1	152,2	167,3	182,4	197,5	212,6
7GN40	65	53	58	14	5	34,5	58,5	48	7	46,5	61,6	76,7	91,8	106,9	122	137,1	152,2	167,3	182,4	197,5	212,6
7GN63	65	53	62	14	5	34,5	58,5	48	7	50,3	68,4	86,5	104,6	122,7	140,8	158,9	177	195,1	213,2	231,3	249,4
7GN125	90	70,5	86	16	6	41,5	84	68	9	67,3	96,4	125,5	154,6	183,7	220,3	249,4	278,5	307,6	336,7	365,8	394,9



GX..

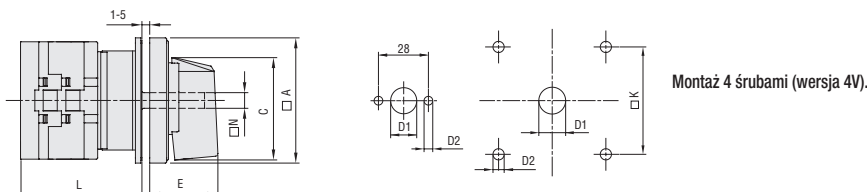

Montaż 4 śrubami (wersja 4V).

Seria	Wymiary							L Liczba segmentów (warstw)											
	□A	C	∅D1	∅D2	E	□K	□N	1	2	3	4	5	6	7	8	9	10	11	12
GX16	48	39,5	12	5	26,5	36	6	43	51,5	60	68,5	77	85,5	94	102,5	111	119,5	128	136,5
GX20	48	39,5	12	5	26,5	36	6	43	51,5	60	68,5	77	85,5	94	102,5	111	119,5	128	136,5
GX32	65	53	14	5	34,5	48	7	51	63	75	85	99	111	123	135	147	159	171	183
GX40	65	53	14	5	34,5	48	7	51	63	75	85	99	111	123	135	147	159	171	183



GN..

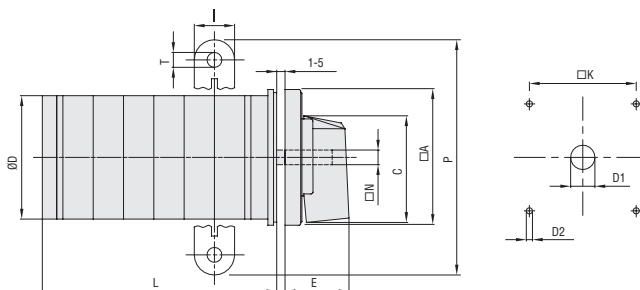

Seria	Wymiary											L Liczba segmentów (warstw) ①											
	□A	C	∅D	∅D1	∅D2	E	I	□K	□N	P	∅T	1	2	3	4	5	6	7	8	9	10	11	12
GN200	132	104	120	16	5,3	56	20	104	10	140	10,5	77	107	136	166	196	226	284	314	343	373	402	432
GN315	132	104	120	16	5,3	56	20	104	10	145	10,5	77	107	136	166	196	226	284	314	343	373	402	432

① W przypadku urządzeń składających się z 6 lub więcej segmentów należy skontaktować się z naszym działem Wsparcia Technicznego (dane na okładce).

Wykonanie do montażu tablicowego z żółto/czerwonym pokrętkiem blokowanym kłódką w pozycji 0 i osłonami zacisków (wersja U25)

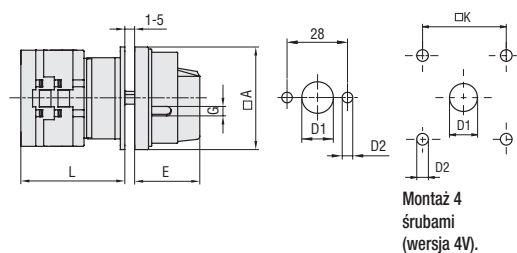
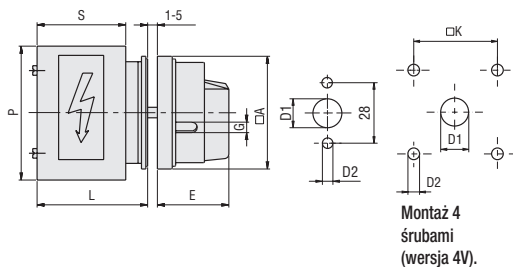

Seria GF

Seria	Wymiary					L				
	□A	D1	D2	E	G	□K	1	2	3.....12	
GF20	48	12	5	34,2	5	36	44	57,5	71	192,5

Seria GX

Seria	Wymiary					L				
	□A	D1	D2	E	G	□K	1	2	3.....12	
GX16	48	12	5	34,2	5	36	43	51,5	60	136,5
GX20	48	12	5	34,2	5	36	43	51,5	60	136,5
GX32	65	14	5	38	6	48	51	63	75	183
GX40	65	14	5	38	6	48	51	63	75	183

Seria 7GN

Seria	Wymiary						S	P	L
	□A	D1	D2	E	G	□K			
7GN12	65	12	5	34,2	5	36	43	64	54,3
7GN20	65	12	5	34,2	5	36	43	64	54,3
7GN25	65	12	5	34,2	5	36	51	68	62,6
7GN32	65	14	5	38	6	48	55	77	71,7
7GN40	65	14	5	38	6	48	55	77	71,7

Wykonanie do montażu tablicowego z żółto/czerwonym pokrętkiem blokowanym kłódką w pozycji 0 i osłonami zacisków (wersja U65)

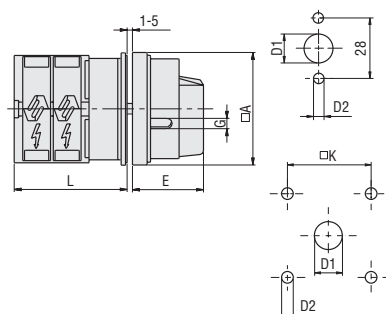

Seria 7GN

Seria	Wymiary					L				
	□A	D1	D2	E	G	□K	1	2	3.....12	
7GN12	65	12	5	34,2	5	36	36,1	45,8	55,5	142,8
7GN20	65	12	5	34,2	5	36	36,1	45,8	55,5	142,8
7GN25	65	12	5	34,2	5	36	40,5	54,1	67,7	190,1
7GN32	65	14	5	38	6	48	46,5	61,6	76,7	212,6
7GN40	65	14	5	38	6	48	46,5	61,6	76,7	212,6
7GN63	65	14	5	38	6	48	50,3	68,4	86,5	249,4
7GN125	90	16	6	49	7	68	67,3	96,4	125,5	394,9

Wykonanie do montażu tablicowego z czarnym pokrętkiem i stopniem ochrony od przodu IP65 (U51)

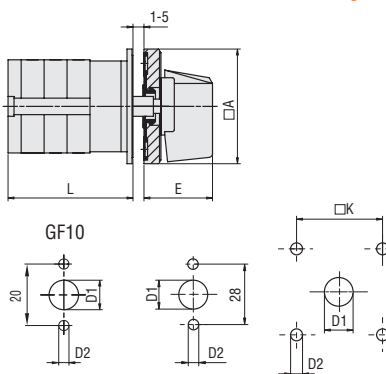

Seria GF

Seria	Wymiary					L			
	□A	D1	D2	E	□K	1	2	3.....12	
GF10	30	9	3,2	18,5	-	40	52	64	●
GF20	48	12	5	26,5	36	44	57,5	71	192,5

● GF10: maksymalnie 8 segmentów.

Seria 7GN

Seria	Wymiary					L			
	□A	D1	D2	E	□K	1	2	3.....12	
7GN12	48	12	5	26,5	36	36,1	45,8	55,5	142,8
7GN20	48	12	5	26,5	36	36,1	45,8	55,5	142,8
7GN25	48	12	5	26,5	36	40,5	54,1	67,7	190,1
7GN32	65	14	5	34,5	48	46,5	61,6	76,7	212,6
7GN40	65	14	5	34,5	48	46,5	61,6	76,7	212,6
7GN63	65	14	5	34,5	48	50,3	68,4	86,5	249,4
7GN125	90	16	6	41,5	68	67,3	96,4	125,5	394,9

Wykonanie do montażu tablicowego w otworze Ø22mm z czarnym pokrętle bez tabliczki (wersja U11)

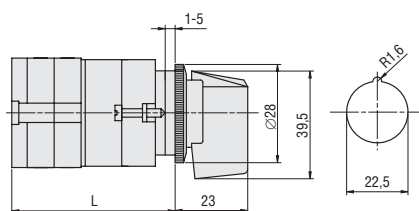

Seria GF

Seria	L			
	1	2	3.....12	
GF20	54,5	68	81,5	203

Seria 7GN

Seria	L			
	1	2	3.....8	
7GN12	47	56,7	66,4	114,9
7GN20	47	56,7	66,4	114,9
7GN25	51,4	65	78,6	146,6

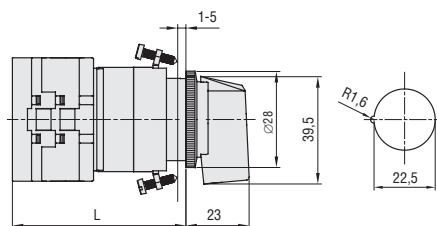

Seria GX

Seria	L			
	1	2	3.....12	
GX16	54	62,5	71	147,5
GX20	54	62,5	71	147,5

Wykonanie do montażu tablicowego w otworze Ø22mm z kluczem bez tabliczki (wersja U12)

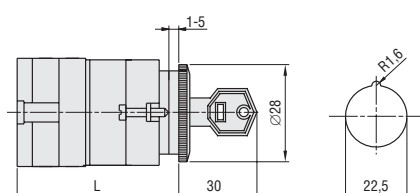

Seria GF

Seria	L			
	1	2	3.....8	
GF20	54,5	68	81,5	149

Seria 7GN

Seria	L			
	1	2	3.....8	
7GN12	47	56,7	66,4	114,9
7GN20	47	56,7	66,4	114,9
7GN25	51,4	65	78,6	146,6

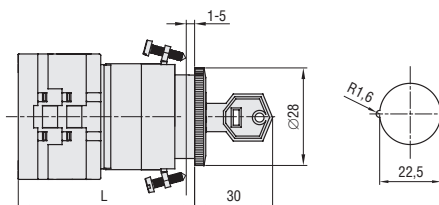

Seria GX

Seria	L			
	1	2	3.....8	
GX16	54	62,5	71	113,4
GX20	54	62,5	71	113,4

Wykonanie do montażu tablicowego w otworze Ø22mm z czarnym pokrętle montowanym na zatrzask (wersja U47)

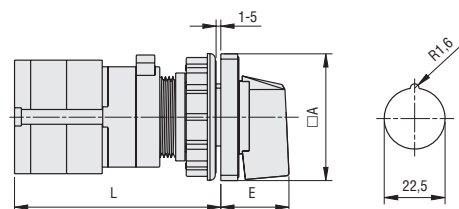

Seria GF

Seria	Wymiary		L			
	□A	E	1	2	3.....8	
GF10	30	18,5	60	72	84	144
GF20	48	26,5	56	69,5	83	150,5

Seria 7GN

Seria	Wymiary		L			
	□A	E	1	2	3.....8	
7GN12	48	26,5	58	67,7	77,4	125,9
7GN20	48	26,5	58	67,7	77,4	125,9
7GN25	48	26,5	62,4	76	89,6	157,6

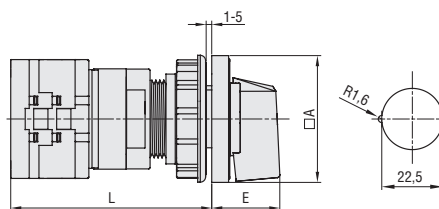

Seria GX

Seria	Wymiary		L			
	□A	E	1	2	3.....8	
GX16	48	26,5	64,9	73,4	81,9	124,4
GX20	48	26,5	64,9	73,4	81,9	124,4

Wykonanie do montażu na płycie z czarnym pokrętkiem (wersja 0)

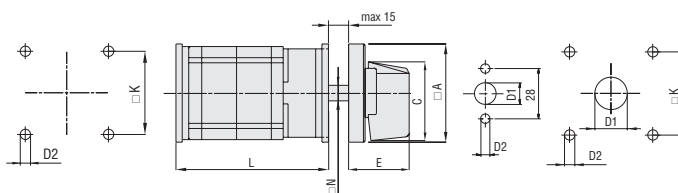

Seria	Wymiary							L Liczba segmentów (warstw)											
	A	C	ØD1	ØD2	E	K	N	1	2	3	4	5	6	7	8	9	10	11	12
GF20	48	39,5	12	5	26,5	36	6	46	59,5	73	86,5	100	113,5	127	140,5	154	167,5	181	194,5

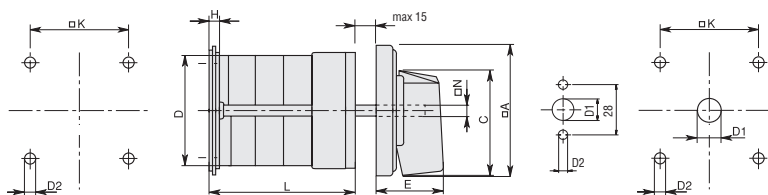

Seria	Wymiary								L Liczba segmentów (warstw)											
	A	C	ØD	ØD2	E	H	K	N	1	2	3	4	5	6	7	8	9	10	11	12
7GN12	48	39,5	39	5	26,5	5	36	6	38,1	47,8	57,5	67,2	76,9	86,6	96,3	106	115,7	125,4	135,1	144,8
7GN20	48	39,5	39	5	26,5	5	36	6	38,1	47,8	57,5	67,2	76,9	86,6	96,3	106	115,7	125,4	135,1	144,8
7GN25	48	39,5	43	5	26,5	5	36	6	42,5	56,1	69,7	83,3	96,9	110,5	124,1	137,7	151,3	164,9	178,5	192,1
7GN32	65	53	58	5	34,5	5,5	48	7	48,5	63,6	78,7	93,8	108,9	124	139,1	154,2	169,3	184,4	199,5	214,6
7GN40	65	53	58	5	34,5	5,5	48	7	48,5	63,6	78,7	93,8	108,9	124	139,1	154,2	169,3	184,4	199,5	214,6
7GN63	65	53	62	6	34,5	7,5	68	7	53,3	71,4	89,5	107,6	125,7	143,8	161,9	180	198,1	216,2	234,3	252,4
7GN125	90	70,5	86	6	41,4	7,5	68	9	74,8	103,9	133	162,1	191,2	220,3	249,4	278,5	307,6	336,7	365,8	394,9

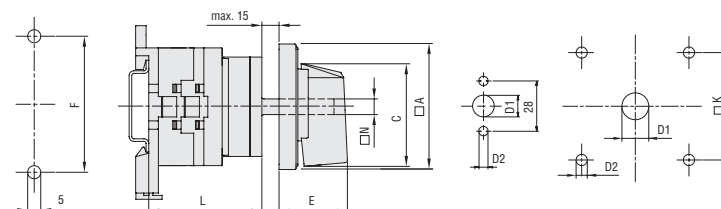

Seria	Wymiary					L Liczba segmentów (warstw)											
	A	C	E	F	N	1	2	3	4	5	6	7	8	9	10	11	12
GX16	48	39,5	26,5	52	6	37	45,5	54	62,5	71	79,5	88	96,5	105	113,5	122	130,5
GX20	48	39,5	26,5	52	6	37	45,5	54	62,5	71	79,5	88	96,5	105	113,5	122	130,5
GX32	65	53	34,5	68	7	48	60	72	84	96	108	120	132	144	156	168	180
GX40	65	53	34,5	68	7	48	60	72	84	96	108	120	132	144	156	168	180

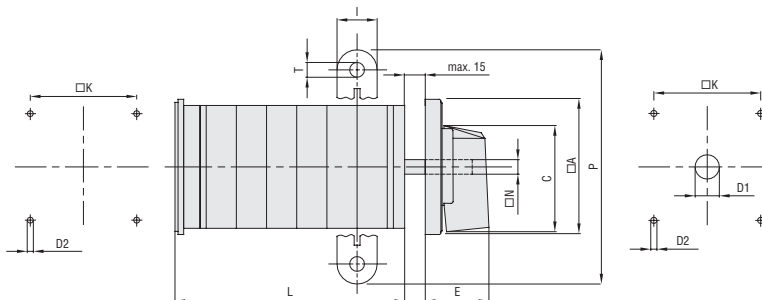

Seria	Wymiary									L Liczba segmentów (warstw) Ⓢ											
	A	C	ØD2	E	I	K	N	P	ØT	1	2	3	4	5	6	7	8	9	10	11	12
GN200	132	104	5,3	56	20	104	10	140	10,5	77	107	136	166	196	226	284	314	343	373	402	432
GN315	132	104	5,3	56	20	104	10	145	10,5	77	107	136	166	196	226	284	314	343	373	402	432

Ⓢ W przypadku urządzeń składających się z 6 lub więcej segmentów należy skontaktować się z naszym działem Wsparcia Technicznego (dane na okładce).

Wykonanie modułowe do montażu na szynie DIN z czarnym pokrętle (wersja 048)

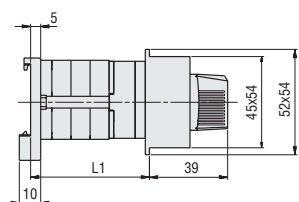

Seria GF

Seria	L1		
	1	2	3
GF20	40	53,5	67

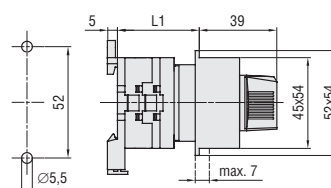

Seria GX

Seria	L1		
	1	2	3
GX16	33	41,5	50
GX20	33	41,5	50

Seria 7GN

Seria	L1		
	1	2	3
7GN12	38,1	47,8	57,5
7GN20	38,1	47,8	57,5
7GN25	42,5	56,1	69,7

Wykonanie do montażu na płycie z żółto/czerwonym pokrętlem blokowanym w pozycji 0, funkcją blokady drzwi i osłonami zacisków (wersja 088)

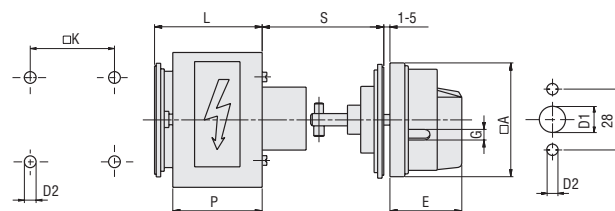
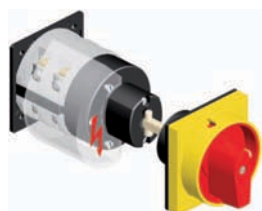

Seria GF

Seria	Wymiary							L			
	□A	D1	D2	E	G	□K	S	1	2	3.....12	
GF20	48	12	5	34,2	5	36	45-55	46	59,5	73	194,5

Seria 7GN

Seria	Wymiary									
	□A	D1	D2	E	G	□K	S	P	L	
7GN12	65	12	5	34,2	5	36	45-55	43	51,3	
7GN20	65	12	5	34,2	5	36	45-55	43	51,3	
7GN25	65	12	5	34,2	5	36	45-55	51	59,6	
7GN32	65	14	5	38	6	48	45-55	55	68,7	
7GN40	65	14	5	38	6	48	45-55	55	68,7	

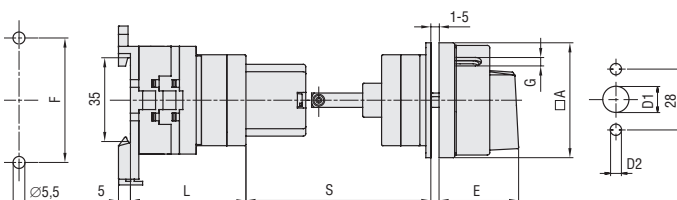

Seria GX

Seria	Wymiary								L			
	□A	D1	D2	E	F	□K	G	S	1	2	3.....12	
GX16	48	12	5	34,2	52	36	5	45-55	40	48,5	57	133,5
GX20	48	12	5	34,2	52	36	5	45-55	40	48,5	57	133,5
GX32	65	14	5	38	68	48	6	45-55	51	63	75	183
GX40	65	14	5	38	68	48	6	45-55	51	63	75	183

Wykonanie do montażu na płycie z żółto/czerwonym pokrętkiem blokowanym w pozycji 0, funkcją blokady drzwi i osłonami zacisków (wersja 098)

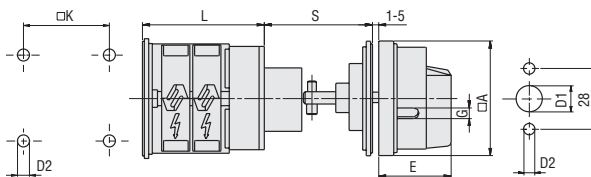

Seria	Wymiary							L			
	□A	D1	D2	E	G	□K	S	1	2	3.....12	
7GN12	65	12	5	34,2	5	36	45-55	41,1	50,8	60,5	147,8
7GN20	65	12	5	34,2	5	36	45-55	41,1	50,8	60,5	147,8
7GN25	65	14	5	38	6	48	45-55	51,5	66,6	81,7	217,6
7GN40	65	14	5	38	6	48	45-55	51,5	66,6	81,7	217,6
7GN63	65	14	6	38	6	68	45-55	57,3	75,4	93,5	256,4

Wykonanie w obudowie z tworzywa z czarnym pokrętkiem (wersja P)
Wykonanie w obudowie z metalu z czarnym pokrętkiem (wersja L)
Wykonanie w obudowie z tworzywa z żółto/czerwonym pokrętkiem blokowanym w pozycji 0 (wersja P25)

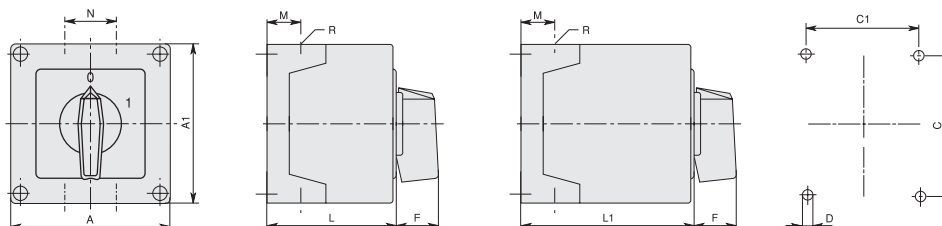

Seria	Wymiary obudowy	Liczba segmentów		Wymiary										Wejście przewodów	Stopień ochrony
		L	L1	A	A1	C	C1	D	F	M	N	L	L1		
7GN12ⓐ	75x75ⓐ	1 - 2	3 - 4	75	75	50	64	4,5	19	14	28	57,5	79,8	4xPG13,5	IP65
7GN20ⓐ		1 - 2	3 - 4												
7GN25ⓐ	90x90	1	2 - 3	90	90	79	63	4,5	25	19	30	71,3	98,3	4xPG16	IP65
7GN12ⓑ		1 - 3	4 - 6												
7GN20ⓑ	90x90	1 - 3	4 - 6	90	90	79	63	4,5	25	19	30	71,3	98,3	4xPG16	IP65
7GN25ⓑ		1 - 2	3 - 4												
7GN32ⓑ	90x90	1 - 2	3 - 4	90	90	79	63	4,5	25	19	30	71,3	98,3	4xPG16	IP65
7GN40ⓑ		1	2 - 3												
7GN12	110x110	1 - 4	5 - 8	110	110	98,4	83	4,5	32	21	39,5	85,5	119,5	4xPG21	IP65
7GN20		1 - 4	5 - 8												
7GN25	110x110	1 - 3	4 - 5	110	110	98,4	83	4,5	32	21	39,5	85,5	119,5	4xPG21	IP65
7GN32ⓐ		1 - 3	4 - 5												
7GN40ⓐ	110x110	1 - 2	3 - 5	110	110	98,4	83	4,5	32	21	39,5	85,5	119,5	4xPG21	IP65
7GN63ⓐ		1 - 2	3 - 4												
7GN63ⓑ	125x175	1 - 2	3 - 4	125	175	146	112	5,5	32	21	68	84,3	118,3	4xPG21 2xPG11	IP65
7GN125		1	2												
7GN32	198x248	-	1 - 8	198	248	190-210	140-180	5,5	32	35	104	-	166,5	6xPG16- 21-29	IP65
7GN40		-	1 - 7												
7GN63ⓐ	198x248	-	1 - 6	198	248	190-210	140-180	5,5	32	35	104	-	166,5	6xPG16- 21-29	IP65
7GN125ⓐⓑ		-	1 - 4												
GX16ⓐⓑ	90x90	1 - 2	3 - 5	90	90	79	79	4,5	25	19	30	71,3	98,3	4xPG16	IP65
GX20ⓐⓑ		1 - 2	3 - 5												
GX16	110x110	1 - 3	4 - 7	110	110	98,4	83	4,5	32	21	39,5	85,5	119,5	4xPG21	IP65
GX20		1 - 3	4 - 7												
GX32ⓐⓑ	110x110	1 - 2	3 - 4	110	110	98,4	83	4,5	32	21	39,5	85,5	119,5	4xPG21	IP65
GX40ⓐⓑ		1 - 2	3 - 4												

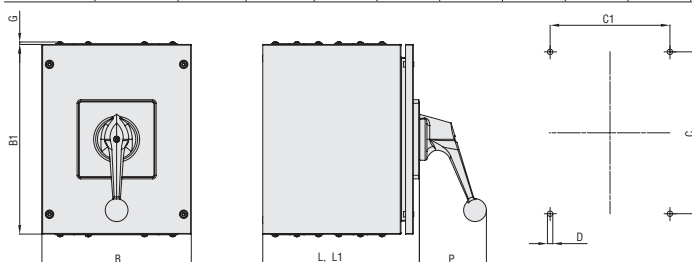

Seria	Wymiary obudowy	Liczba segmentów		Wymiary										Stopień ochrony
		L	L1	L	L1	B	B1	C	C1	D	G	P		
GN200	250x316	1 - 3	4 - 6	162	252	250	316	270	200	9	4,5	98	IP54	
GN315		1 - 3	4 - 6	162	252	250	316	270	200	9	4,5	98		

ⓐ Standardowe wymiary wykonania w obudowie z tworzywa z czarnym pokrętkiem (wersja P).
 ⓑ Standardowe wymiary wykonania w obudowie z tworzywa z żółto/czerwonym pokrętkiem blokowanym kłódką w pozycji 0 (wersja P25).
 ⓐ Tylko dla wykonania w obudowie z tworzywa z czarnym pokrętkiem (wersja P).

ŁĄCZNIKI KRZYWKOWE SERII GNA20

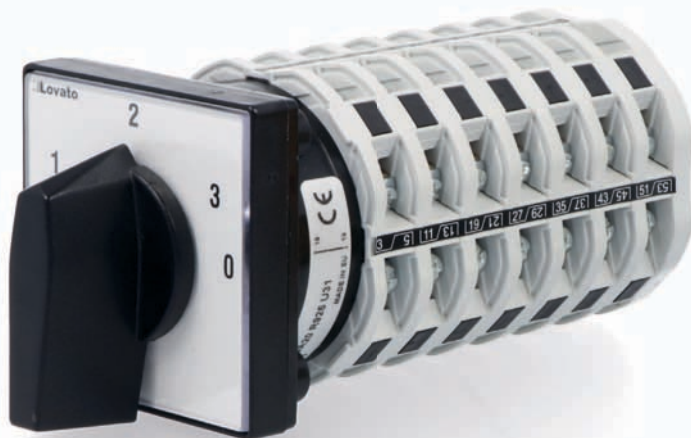

- ZNAMIONOWY PRĄD TERMICZNY ITH: 20A
- DOSTĘPNE WERSJE W OBUDOWIE Z TWORZYWA SZTUCZNEGO

Montaż tablicowy z czarnym pokrętem

● DO 48 STYKÓW

Seria łączników krzywkowych GNA20 ma 4 styki dla każdej warstwy. Może mieć maksymalnie 12 pozycji sterowania i 12 warstw przełączających, co daje w sumie **48 dostępnych styków**.

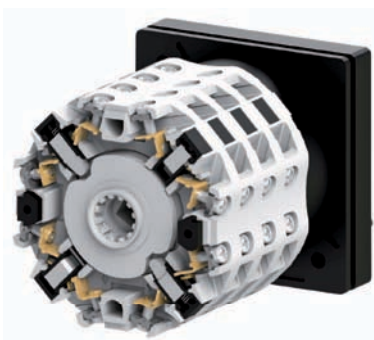

Montaż tablicowy z żółto/czerwonym pokrętem blokowanym kłódką

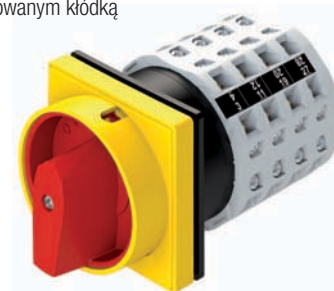

● ZREDUKOWANA GŁĘBOKOŚĆ KORPUSU

Łączniki krzywkowe serii GNA20 są używane w aplikacjach, w których dostępna głębokość wewnątrz rozdzielnic jest ograniczona

Przykład porównania serii GNA20 z 7GN:

Seria GNA20: 6 warstw, 24 styki

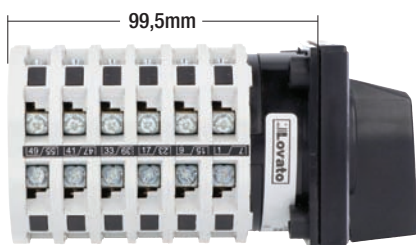

Seria 7GN: 12 warstw, 24 styki.

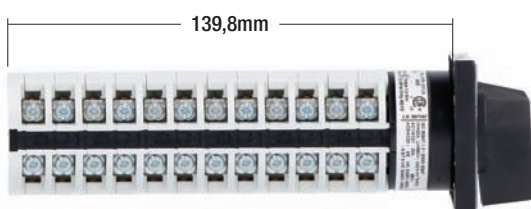

Montaż na płycie z czarnym pokrętem



Kody dla serii GNA20 można uzyskać w naszym dziale Wsparcia Technicznego (dane na okładce).

Akcesoria do łączników krzywkowych



7A014 - 7AR114 -
7A114 - 7AR214



7AR124 - 7A124 -
7AR224 - 7AR324



GXM0 - GXM1 - GXM2 - GXM3 - GXM4



GXM5 - GXM6 - GXM7



7A019... -
7A119...

7A169...



7A180 - 7A181



7A44...

Kod zamówienia	Opis	Ilość w opak.	Masa [kg]
		szt.	

Pokrętko w kolorze czarnym ❶.

7A014	Do tabliczki 48x48mm □6mm	1	0,005
7AR114	Do tabliczki 65x65mm □6mm	1	0,010
7A114	Do tabliczki 65x65mm □7mm	1	0,010
7AR214	Do tabliczki 90x90mm □7mm	1	0,013

Dźwignia w kolorze czarnym ❶.

7AR124	Do tabliczki 65x65mm □6mm	1	0,019
7A124	Do tabliczki 65x65mm □7mm	1	0,020
7AR224	Do tabliczki 90x90mm □8mm	1	0,038
7AR324	Do tabliczki 132x132mm	1	0,050

Pokrętko żółto/czerwone 0-1, blokowane kłódką.

GXA01	48x48mm □6mm	1	0,030
GXA01H	65x65mm □6mm	1	0,047
GXA11	65x65mm □7mm	1	0,047

Tabliczki przednie IP40.

GXM0	Tabliczka przednia, etykieta bez opisu, 30x30mm	1	0,012
GXM1	Tabliczka przednia, etykieta bez opisu, 48x48mm	1	0,018
GXM2	Tabliczka przednia, etykieta bez opisu, 65x65mm	1	0,023
GXM3	Tabliczka przednia, etykieta bez opisu, 90x90mm	1	0,030
GXM4	Tabliczka przednia, etykieta bez opisu, 132x132mm	1	0,040

Tabliczki przednie z miejscem na opis IP40.

GXM5	Tabliczka przednia z miejscem na opis, bez opisu, 48x60mm	1	0,017
GXM6	Tabliczka przednia z miejscem na opis, bez opisu, 65x80mm	1	0,033
GXM7	Tabliczka przednia z miejscem na opis, bez opisu, 90x110mm	1	0,055

Oslony ochronne IP20 zacisków zasilania.
Do 2 warstw z wkrętami i adapterem.

7A0191	Do 7GN12-7GN20	1	0,017
7A0192	Do 7GN25	1	0,021
7A119U	Do 7GN32-7GN40, wykonanie U	1	0,033
7A119O	Do 7GN32-7GN40, wykonanie O	1	0,101

Zestaw 2 sztuk do 1 segmentu, montaż na zatrask.

7A1691	Do 7GN32-7GN40	1	0,005
7A1692	Do 7GN63	1	0,006
7A1693	Do 7GN125	1	0,020
7A1694	Do 7GN12-7GN20	1	0,005
7A1695	Do 7GN25	1	0,005

Adapter do montażu na szynie 35mm,
DIN 46277/3 do wykonania U...

7A180	Do 7GN12...7GN25 i GF20	1	0,011
7A181	Do 7GN32...7GN63	1	0,018

Gumowa osłona IP42 ❷. Do przycięcia.

7A441	Ø57mm - długość 90mm do 7GN12-7GN20-7GN25 na 2 segmenty	1	0,045
7A442	Ø57mm - długość 115mm do 7GN12-7GN20-7GN25 na 3 do 4 segmentów	1	0,065
7A443	Ø57mm - długość 140mm do 7GN12-7GN20-7GN25 na 5 do 6 segmentów	1	0,063
7A444	Ø87mm - długość 112mm do 7GN32...7GN40 do 4 segmentów, do 7GN63 do 3 segmentów	1	0,065

Zapasowe klucze.

GXA170	Klucze zapasowe, kod 122	1	0,008
--------	--------------------------	---	-------

❶ Wymiar trzpienia podano przy różnych wykonaniach □N.
❷ Zwiększa stopień ochrony zacisków z IP00 na IP20.

ROZŁĄCZNIKI

90-91-10-92

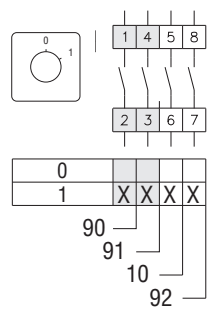

05-06-07-08

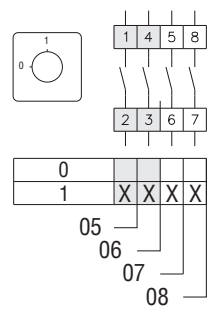

03

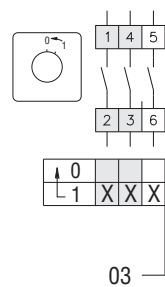

PRZEŁĄCZNIKI Z 0

51-52-53-75

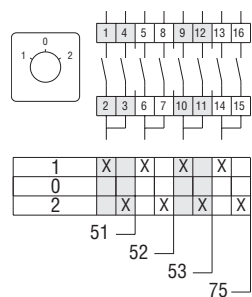

PRZEŁĄCZNIKI BEZ 0

54-55-56-69

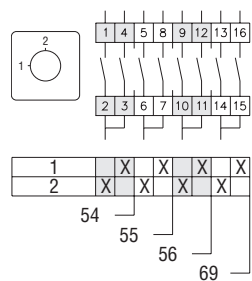

WIELOPOZYCYJNE, POCZĄTEK OD 1
82-86-93

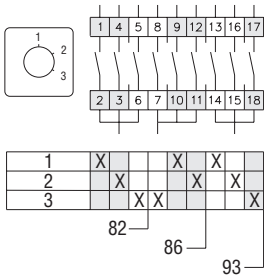

83-87-94

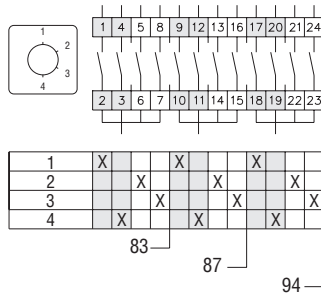

84

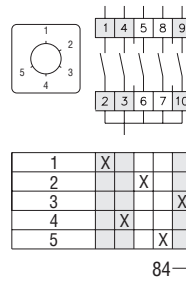

85

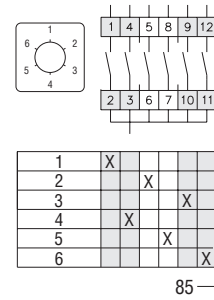

WIELOPOZYCYJNE, POCZĄTEK OD 0
107-123-135

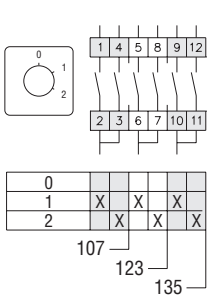

108-124-136

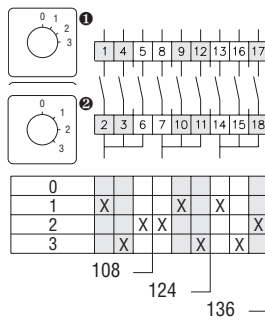

109

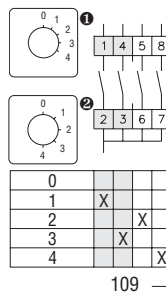

110

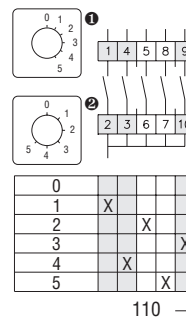

- ❶ Tabliczka do GF..., 7GN12...7GN63..., GX..., GN...
- ❷ Tabliczka do 7GN125...

PRZEŁĄCZNIKI WOLTOMIERZY

66

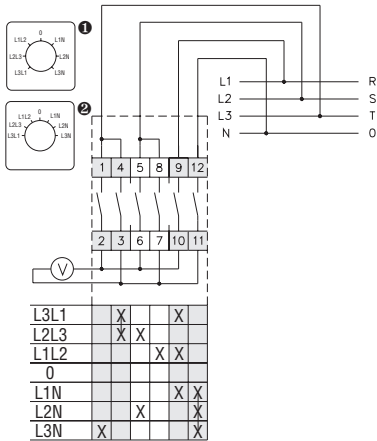

- 1 Tabliczka do GF20..., 7GN..., GX..., GN...
- 2 Tabliczka do GF10...

67

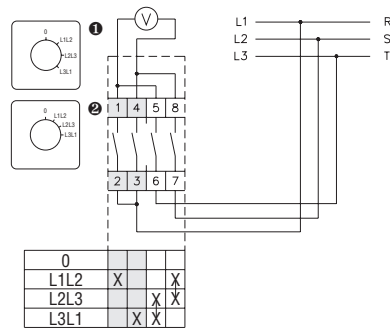

68

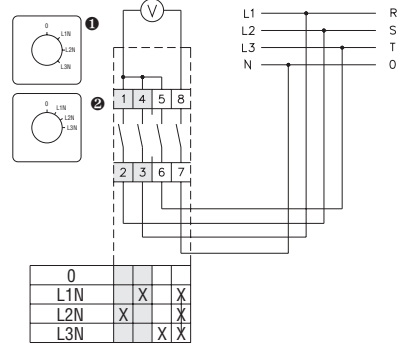

PRZEŁĄCZNIKI AMPEROMIERZY

97

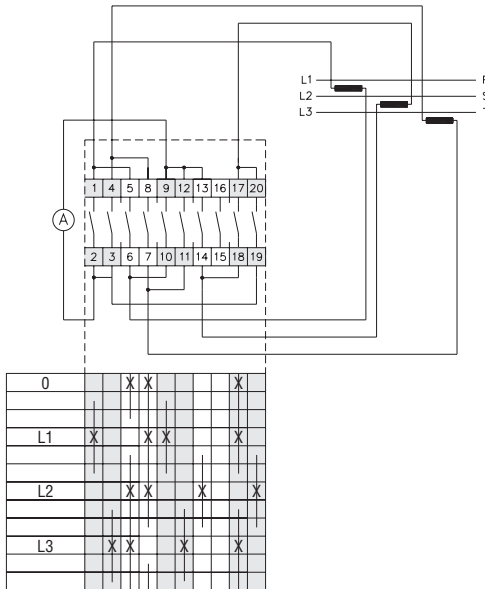
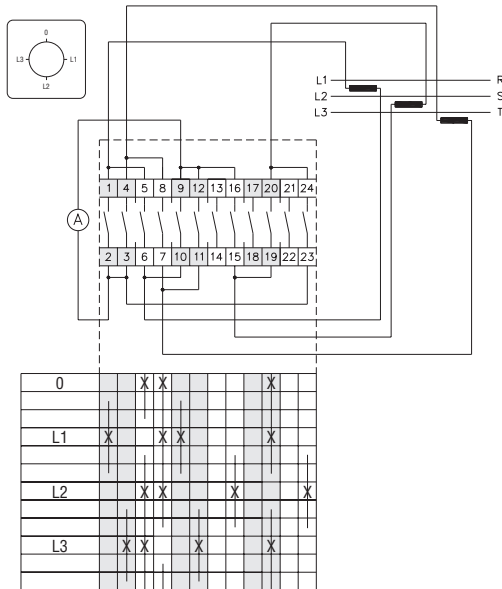

98

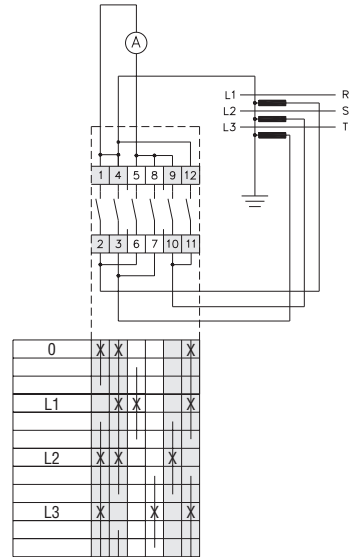

PRZEŁĄCZNIKI ZMIANY KIERUNKU OBROTÓW SILNIKA

25

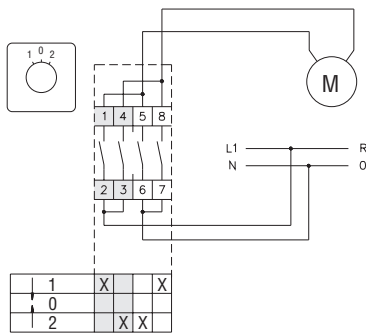

11

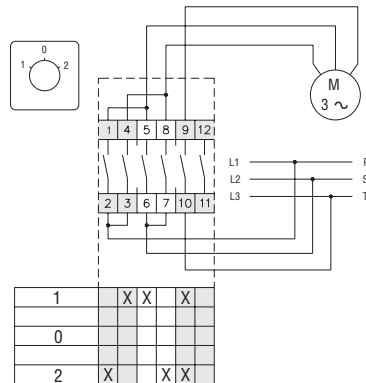

26

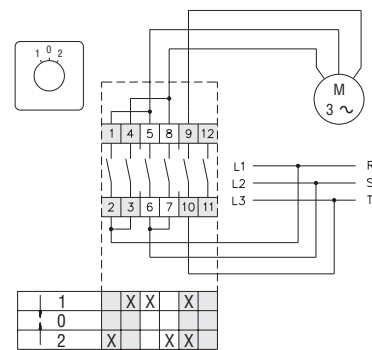

PRZEŁĄCZNIKI GWIAZDA-TRÓJKĄT

12

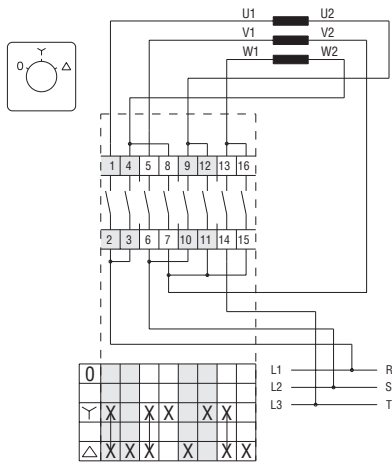

DO SILNIKÓW DAHLANDERA

13

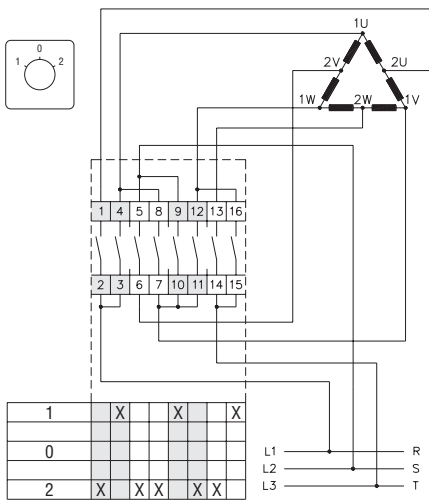

19

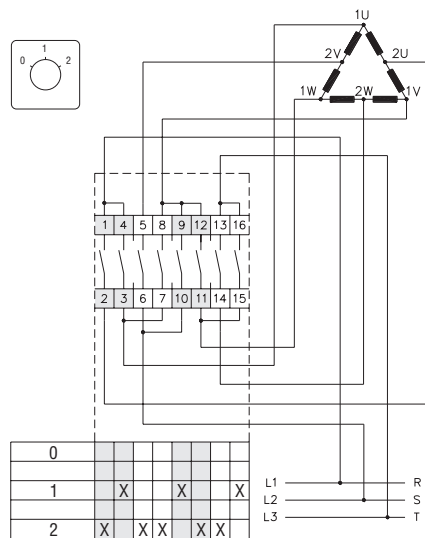

12

20

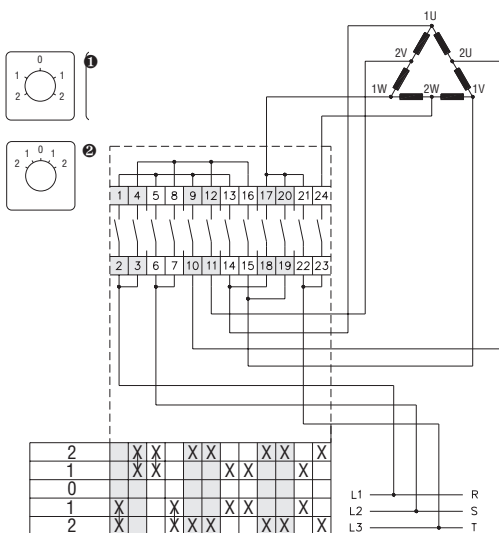

DO SILNIKÓW DWUBIEGOWYCH

53

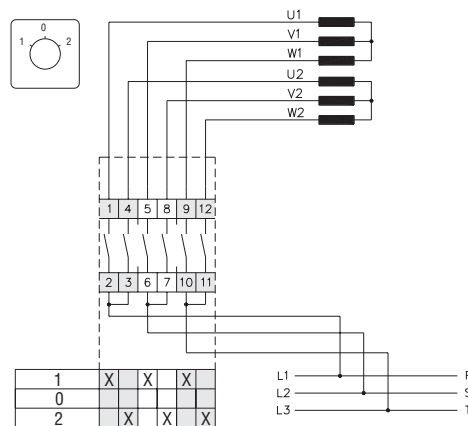

① Tabliczka do GF20..., 7GN..., GX...
 ② Tabliczka do GF10..., GN...

TYP		GF10	GF20	7GN12	7GN20	7GN25	7GN32	7GN40	7GN63	7GN125	GX16	GX20	GX32	GX40	GN200	GN315	GNA20			
Znamionowe napięcie izolacji																				
Ui IEC/EN	V	480	480	690	690	690	690	690	690	690	690	690	690	690	690	690	690			
UL/CSA	V	240	240	600	600	600	600	600	600	600	600	600	600	600	600	600	600			
Znamionowe napięcie udarowe Uimp IEC/EN 60947-3	kV	4	4	6	6	6	6	6	6	6	6	6	6	6	8	8	6			
Znamionowy prąd termiczny I _{th} IEC/EN	A	10	20	16	20	25	32	40	63	125	16	20	32	40	200	315	20			
UL/CSA (ogólne zastosowanie)	A	10	15	15	20	30	40	50	60	130	12	15	32	40	200	255	15			
Maksymalne znamionowe napięcie pracy (tylko rozłączniki)	V	480	480	480	480	480	480	480	480	690	440	440	440	440	690	690	480			
Znamionowe napięcie udarowe (tylko rozłączniki)	kV	4	4	4	4	4	4	4	4	6	4	4	4	4	6	6	4			
Maksymalna wartość In bezpiecznika do ochrony zwarciowej (typ gG)	10kA	A	16	20	16	20	25	32	40	63	125	16	20	35	40	200 [Ⓜ]	315 [Ⓜ]	20		
	15kA	A	–	20	10	16	25	32	40	63	100	16	20	35	35	200 [Ⓜ]	315 [Ⓜ]	20		
	25kA	A	–	20	10	16	25	32	40	63	100	16	20	35	35	–	–	20		
	50kA	A	–	–	–	–	–	–	32	40	63	100	–	–	–	–	–	–		
	63kA	A	–	–	–	–	–	–	40	63	100	–	–	–	–	–	–	–		
Prąd udarowy wytrzymywany I _{cw} 1sek.	A	250	250	200	250	400	800	1000	1600	2100	250	250	1000	1000	3300	5200	220			
Przewodność	mAV	10/5	10/5	10/5	10/5	10/5	10/5	10/5	10/5	10/5	10/5	10/5	10/5	10/5	–	–	10/5			
Znamionowy prąd roboczy I _e AC1/AC21A (IEC/EN)	A	10	20	16	20	25	32	40	63	125	16	20	32	40	200	315	20			
AC15 (IEC/EN)	110...120V	A	5	10	10	10	16	25	25	32	40	10	10	25	25	–	–	–		
	220...230V	A	3	8	8	8	12	20	22	25	28	8	8	20	22	–	–	–		
	380...400V	A	2	6	4	6	8	10	12	15	15	4	6	10	12	–	–	–		
	660...690V	A	–	–	1,5	1,5	2	2	2	4	5	1,5	1,5	2	2	–	–	–		
Rozłączniki do silników w kategorii obciążenia AC AC3 (IEC/EN)	3 fazy	220...230V	kW	1,5	3	2,5	3	5,5	7,5	8	11	18,5	3,5	3,7	7,5	7,5	27,5	37	3	
		380...440V	kW	2,2	5	4	5,5	7,5	11	15	18,5	37	4,5	5,5	11	15	47	55	5,5	
		500...690V	kW	–	–	5,5	5,5	7,5	11	15	18,5	33	5,5	5,5	11	15	–	69	5,5	
	1 faza (2 pola)	110...120V	kW	0,3	0,5	0,8	0,8	1,5	2,2	3	3,7	5	0,55	0,75	1,8	2,2	–	11	0,6	
		220...230V	kW	0,55	1,5	1,5	2,2	3	4	6,5	6,5	11	1,5	1,8	3,5	4,4	–	22	2,2	
		380...440V	kW	0,75	2	2,2	3	5,5	6,5	8	11,5	15	2,2	3	5,5	7	–	30	3	
	AC23A (IEC/EN)	3 fazy	220...230V	kW	1,8	4	3	5	6,5	8	8	12,5	30	3,7	4	8	9	–	75	3,7
			380...440V	kW	3	7,5	5,5	7,5	11	15	18,5	30	45	6,5	7,5	15	18,5	47	110	7,5
			500...690V	kW	–	–	7,5	7,5	11	18,5	22	30	37	7,5	7,5	15	15	–	45	7,5
1 faza (2 pola)		110...120V	kW	0,7	0,75	0,8	0,8	1,5	2,2	3	3,7	5	0,75	0,75	2,2	3	–	15	0,75	
	220...230V	kW	0,75	2	1,7	2,5	3,7	4	6	7,5	11	1,8	2,2	3,5	5,2	–	37	2,2		
	380...440V	kW	1,1	2,5	3	3,7	5,5	7,5	11	12,5	15	3	3,5	6	7,5	–	55	3,7		

Ⓜ Dla GN200 i GN315 kategoria obciążenia to AC23B.

Ⓜ Wkładki bezpiecznikowe typu aR.

TYP		GF10	GF20	7GN12	7GN20	7GN25	7GN32	7GN40	7GN63	7GN125	GX16	GX20	GX32	GX40	GN200	GN315	GNA20		
Rozłączniki do silników																			
Rozruch bezpośredni (UL/CSA-DOL) 3 fazy																			
	120V	HP	–	–	1,5	1,5	3	5	5	7,5	15	1,5	1,5	3	5	30	30	1,5	
	240V	HP	2	3	3	3	5	10	10	15	25	3	3	7,5	10	50	50	2	
	480V	HP	–	–	–	7,5	10	15	20	25	50	5	5	15	15	100	100	5	
	600V	HP	–	–	–	10	15	15	20	25	40	5	5	15	15	75	75	5	
1 faza (2 pola)																			
	120V	HP	–	–	0,5	0,75	1,5	2	2	3	5	0,75	0,75	1,5	2	15	15	–	
	240V	HP	0,75	1	1	2	3	5	5	10	15	1	1,5	3	5	30	30	–	
Rozłączniki do silników w kategorii obciążenia prądem stałym																			
DC21A																			
	48V	A	10	20	12	20	25	32	40	63	125	16	20	32	40	200	200	–	
	60V	A	7	20	12	20	25	32	40	50	80	16	20	32	40	200	200	–	
le	110V	A	2	4	4	4	4	6	6	8	10	4	4	5	6	35	35	–	
	220V	A	0,7	0,7	0,6	0,6	0,7	0,9	0,9	1	1,2	0,6	0,6	0,8	0,8	2,5	2,5	–	
	440V	A	0,2	0,2	0,25	0,25	–	–	–	–	–	0,25	0,25	0,25	0,25	0,9	0,9	–	
DC23A																			
	24V	A	–	–	10(1)	20(1)	25(1)	32(1)	40(1)	50(1)	125(1)	16(1)	20(1)	32(1)	40(1)	–	–	–	
	48V	A	–	–	10(2)	20(2)	25(2)	32(2)	40(2)	50(2)	125(2)	16(2)	20(2)	32(2)	40(1)	–	–	–	
le	60V	A	–	–	10(3)	20(3)	25(3)	32(3)	40(3)	50(3)	125(3)	16(3)	20(3)	32(3)	40(3)	–	–	–	
Przy szeregowym połączeniu liczby pól podanej w nawiasie																			
	110V	A	–	–	5(3)	10(3)	12(3)	15(3)	20(3)	25(3)	50(3)	10(3)	10(3)	15(3)	40(3)	–	–	–	
	220V	A	–	–	5(4)	8(4)	10(4)	12(4)	12(4)	15(4)	20(4)	7(4)	8(4)	12(4)	12(4)	–	–	–	
DC13																			
	24V	A	3	6	12	20	25	32	40	63	125	16	20	32	40	–	–	–	
	48V	A	3	6	10	16	20	25	32	40	100	14	16	25	32	–	–	–	
le	60V	A	2	3	8	12	16	16	16	28	50	10	12	14	16	–	–	–	
	110V	A	1	1	1	1	1,5	3	3	3,3	4	1	1	3	3	–	–	–	
	220V	A	0,3	0,4	0,4	0,4	0,4	0,5	–	–	–	0,4	0,4	0,5	0,5	–	–	–	
	440V	A	0,1	0,15	0,15	0,15	–	–	–	–	–	0,15	0,15	0,15	0,15	–	–	–	
Rozproszenie mocy		W/pole	0,4	0,8	0,8	0,8	1,1	1,5	2,0	3,4	6,3	0,6	0,6	1,6	1,6	26	64,5	1	
Trwałość mechaniczna		cykli	1x10 ⁶	1x10 ⁶	3x10 ⁶	5x10 ⁶	5x10 ⁶	5x10 ⁶	5x10 ⁶	5x10 ⁶	1x10 ⁶	1x10 ⁶	1x10 ⁶	1x10 ⁶	1x10 ⁶	2x10 ⁵	2x10 ⁵	1x10 ⁶	
Śruba zacisku		M	2,5	3	3	3	3,5	4	4	5	2x5	3	3	4	4	10	10	3	
Moment obrotowy		maks. Nm	0,4	0,5	0,5	0,5	0,8	1,2	1,2	2	2	0,5	0,8	1,2	1,2	10	10	0,5	
Przekrój przewodów		maks. drut/linka	2xmm ²	1,5/1,5	2,5/2,5	2,5/2,5	2,5/2,5	4/4	6/4	10/6	16/10	50/50	2,5/2,5	2,5/2,5	10/6	10/6	1x95	1x185	2,5/25
			2xAWG	14/14	12/12	12/14	12/14	10/12	8/10	8/10	6/8	1/0 / 1/0	12/12	12/12	8/10	8/10	1x3/0	1xmm ² 350	12/14
		min. drut/linka	2xmm ²	0,5/0,5	0,5/0,5	0,5/0,5	0,5/0,5	0,5/0,5	1,5/1,5	1,5/1,5	2,5/2,5	2,5/2,5	0,5/0,5	0,5/0,5	1,5/1,5	1,5/1,5	–	–	0,5/0,5
			2xAWG	20/20	20/20	20/20	20/20	20/20	16/16	16/16	14/14	14/14	20/20	20/20	16/16	16/16	–	–	20/20
WARUNKI OTOCZENIA																			
Temperatura pracy		°C	–25...+55																
Temperatura składowania		°C	–40...+70																